

## CONTROL OF FIAT MULTIAIR VALVE-LIFT SYSTEM USING ATMEGA MICROCONTROLLER

Szymon Racewicz, Arkadiusz Olejnik

*University of Warmia and Mazury in Olsztyn  
Department of Mechatronics and Technical-Computer Sciences Education  
Oczapowskiego Street 11, 10-719 Olsztyn, Poland  
tel.: +48 89 524 54 87, fax: +48 89 524 51 50  
e-mail: szymon.racewicz@uwm.edu.pl*

### **Abstract**

*The article presents a device based on the ATmega microcontroller for precise Fiat MultiAir valve-lift system control. The Fiat MultiAir system is the patented electromechanical actuation system of the inlet valves. It allows a control of the inlet valves open time for each combustion chamber independently. The described device has been installed in the Fiat 0.9 TwinAir CNG 80 HP internal combustion engine controlled by the ECU Master open motor controller. As the ECU Master Controller software and hardware does not support Fiat's MultiAir system control, the above-mentioned device had to be designed. The device consists of the ATmega88 microcontroller, which analyses the signals from the shaft and the cam sensors. Then, the DC converter is powering the solenoid valves of the MultiAir system via two transistors. When the solenoid valve is closed, the incompressible hydraulic fluid transmits the inlet-cam lobe's motion to the valve as in a traditional engine. When the solenoid valve is open, the oil bypasses the passage, decoupling the valve, which then closes conventionally via spring pressure. In order to find the specific moments of turning the solenoids on and off the measurements on the original Fiat motor controller have been performed. The acquired oscillograms have been analysed and presented in the article. Studied Fiat 0.9 TwinAir engine is a part of the power generation unit and has been coupled with the three-phase electric power generator MeccAlte 16 kW with an AC exciter.*

**Keywords:** Fiat MultiAir system, valve-lift system, variable valve timing, open motor controller

### **1. Introduction**

Nowadays the renewable energy is playing the more and more important role in the global energy market. Because of fast decreasing fossil fuel, resources not only like coal or petroleum but also because the production cost of 1 kWh of so-called green energy is now much more profitable and achievable than a few decades ago. Not to mention the growing demand for the environment protection, which forces the biggest energy, companies to implement the newest technology achievements for continuous reduction of pollution emissions. These two trends, of growing green energy production and decreasing pollution emission, meet together in the power generation units design. As the synchronous generators are still one of the most used machines for energy generation they are widely used in the Autonomous Electrical Power Systems (AEPS) [1, 2]. Moreover, synchronous machines can be also used as the starting devices of some external torque sources like jet or combustion engines [3, 4]. Generally, mechanical energy delivered to the system can be also provided by a water flow, high-pressure steam or wind. The stationary AEPSs with a combustion engines are often used as the Combined Heat and Power systems (CHP). It means that they are producing useful energy in terms of heat and electricity rising in that way the overall energy efficiency of the whole unit [5]. The combustion engine driving the generator is generally powered by petrol, diesel, compressed natural gas (CNG) or more and more often by a biogas, which is a renewable energy source.

Thanks to the MultiAir valve-lift system technology one can observe not only a reduction in the fuel consumption and the lower pollution emission but also a horsepower boost [6]. This

system has been originally designed for automotive applications but its above-mentioned economic advantages have encouraged the authors of the article to adopt the system for the power-generating unit. The studied power generating unit (Fig. 1) consists of the Fiat 0.9 TwinAir CNG 80 HP internal combustion engine which can be powered by petrol, LPG gas blends or compressed natural gas (CNG) [7]. It is controlled by the ECU Master open motor controller [8]. This open controller supports several variable valve timing (VVT) systems like VTEC, iVTEC (Honda), VVTI (Toyota), VVL (Nissan), or even Double Vanos (BMW). Unfortunately, there is no support for the Fiat's MultiAir system. As the application of the MultiAir technology to the power generation units leads to significant fuel economy, emission benefits and power increase for different load conditions resulting from the natural AEPS operating modes, the external MultiAir controller has been designed and tested.

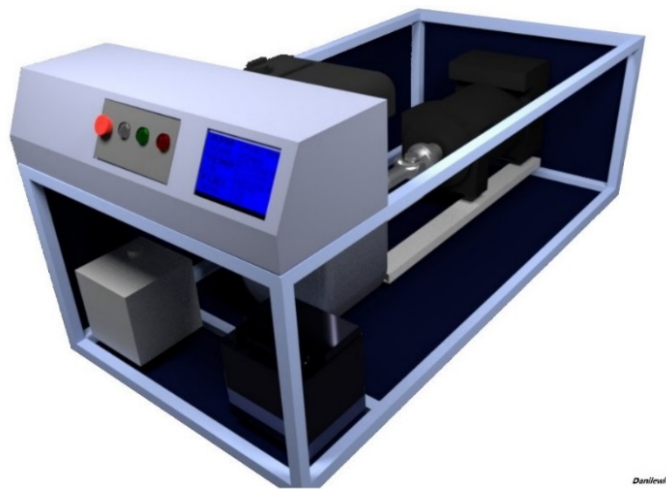

Fig. 1. Visualization of the designed power generation unit

## 2. MultiAir technology

Variable Valve Timing (VVT) system has been introduced to automotive motors by Alfa Romeo in 1981 (model Spider). Then, after some improvements made by Honda in 1989 (VTEC system) the idea started to be applied by other automotive companies. The main purpose of the VVT systems is modulating of the valves open and close angle according to the engine actual load and speed. Generally, this strategy enables a fuel consumption reduction with dynamics amelioration at the same time. Moreover, improved engine performances contribute to meet the higher and higher emission standards. There are many methods to achieve variable valve opening time, from mechanical to electro-hydraulic. Aside many advantages of the VVT systems there is one main disadvantage which is their complexity, and hence the price of production and maintenance. Nevertheless, nowadays almost every automotive company has an engine with VVT system in his offer.

The MultiAir system is a Fiat's technology, which allows controlling the procedure and the open time of the inlet valves by removing the direct mechanical link between the camshaft and the inlet valves. It uses an incompressible hydraulic fluid to couple the inlet valves with the camshaft. There is one common camshaft for the inlet and the outlet valves but these last are activated conventionally via outlet-cams and closed by a spring pressure. For the inlet part, the hydraulic fluid is running from a small piston (4) actuated by the finger follower (5) and the inlet-cam lobe (6) to the inlet valve hydraulic actuators (2) via solenoid valve (1). Opening of this solenoid valve leads to an immediate decoupling of the inlet valves (1) which are then closed by a spring pressure. Such a construction, shown on the Fig. 2, enables several procedures of the inlet valves control.

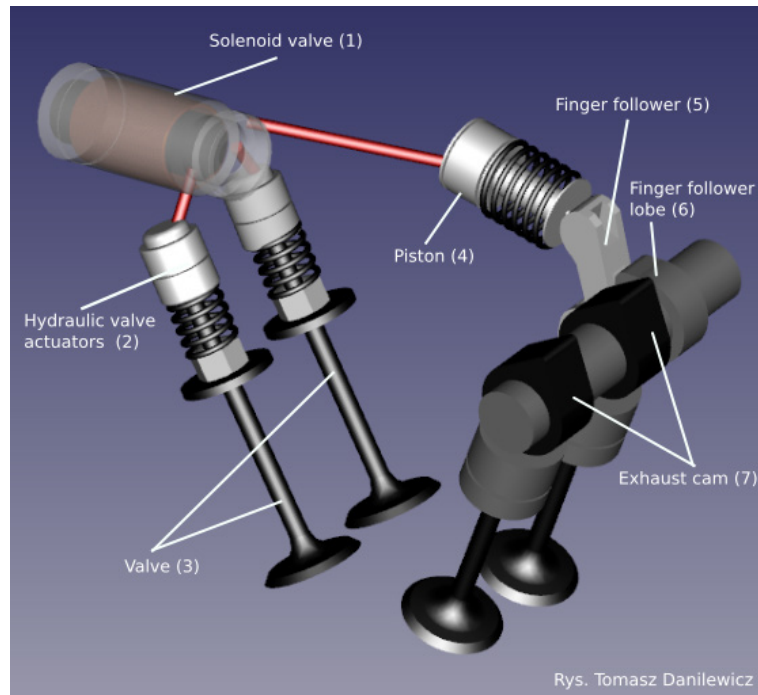

Fig. 2. Schematic diagram of the Fiat MultiAir valve-lift system

When the solenoid valve (1) remains shut during whole cycle of the inlet-cam lobe (6) motion, the oil pressure opens the inlet valves (3) directly according to the inlet-cam profile. It is so called Full Lift (FL) mode, which is designed for high power at high speeds (Fig. 3A). In order to improve efficiency and torque curve during partial load at low speeds of the engine, the inlet valves can close earlier, what minimises the problem of exhaust gases being pushed back into the inlet tract. This mode is called Early Intake Valve Closing (EIVC) and has been presented on Fig. 3C and Fig. 3D. When the solenoid valve is activated later, one can obtain the Late Intake Valve Opening (LIVO) designed for minimal load conditions and idling. In this mode the intake valves movement is reduced to speed up the inlet charge into the cylinders (Fig. 3B). The last possibility is to open the inlet valves twice which for the cars is used in the urban conditions. The solenoid valve is activated (closed) at the beginning of the inlet-cam lobe motion, and then it is opened for immediate oil pressure drop and the inlet valve closing. Next, it is activated again in order to obtain valve movement similar to LIVO motion mode (Fig. 3E). This strategy is used for better swirl and combustion of the petrol/air mix.

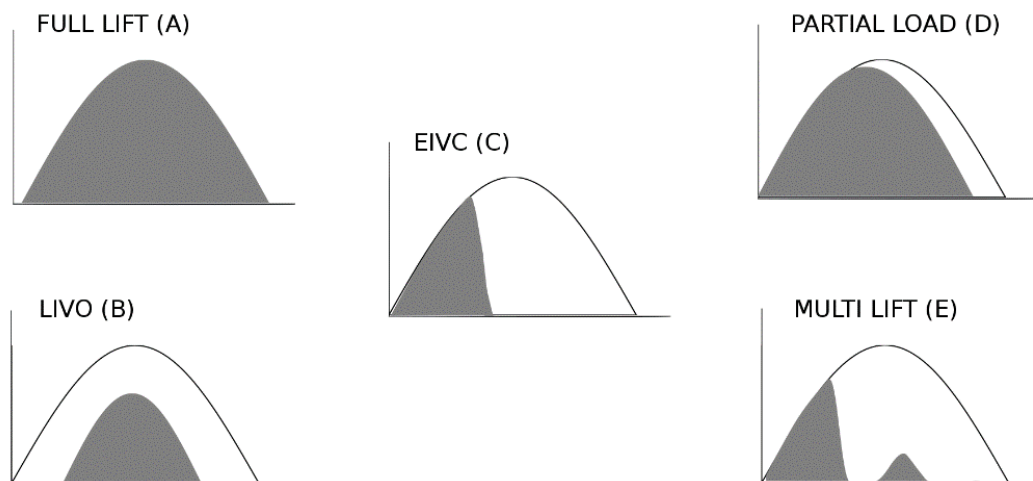

Fig. 3. Fiat MultiAir control strategies for the inlet valves

### 3. MultiAir controller

The MultiAir driver has been designed as a standalone hardware module what means that it does not require any given ECU unit in order to operate. The device is based on the AVR ATmega88 microcontroller with external 18.432 MHz crystal oscillator, which should provide sufficient computing power to generate the control signals for the MultiAir system at the synchronous speed of the generator (3 000 rpm).

The device consists of 3 main circuits: input signal conditioning (1), algorithm execution (2) and solenoid power output (3) (Fig. 4).

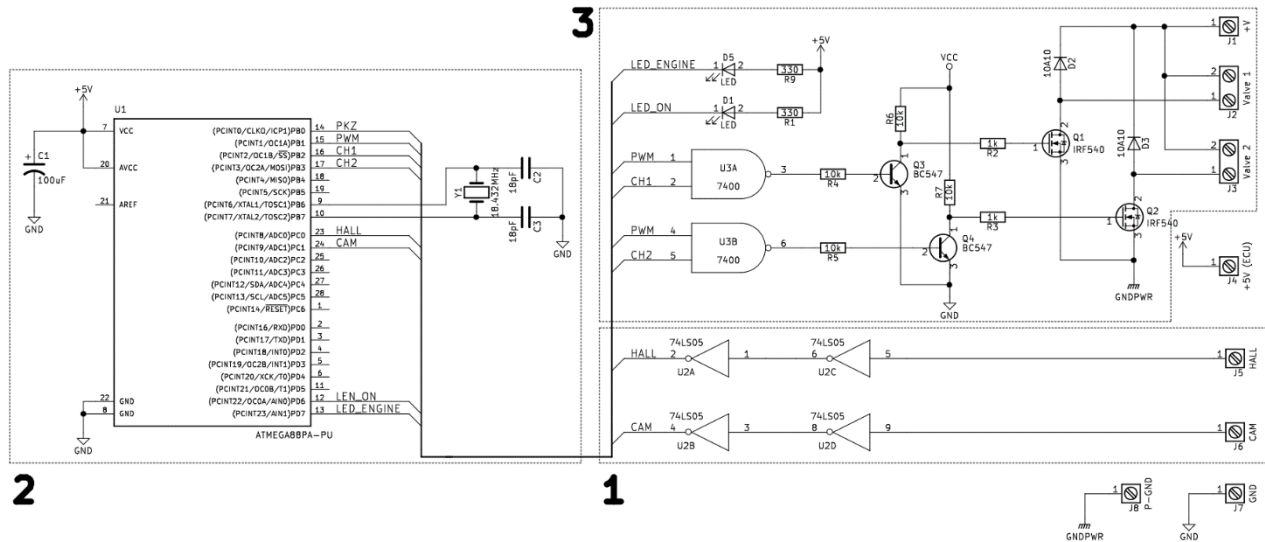

Fig. 4. Electric diagram of the designed device

In the signal conditioning circuit, one has decided to provide a double inverting CMOS buffer for filtering the input signals. This simple, yet effective solution ensures an excellent signal filtration and does not bring in any visible delay in the input signal propagation (Fig. 5).

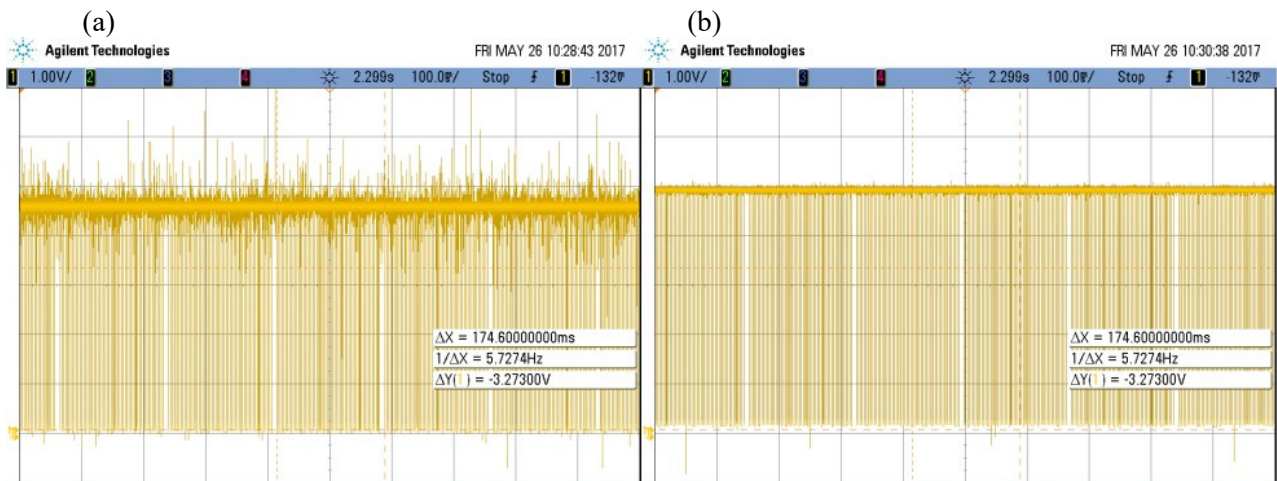

Fig. 5. Hall sensor output before (a) and after (b) dual buffer conditioning

The second circuit of the device executes the control algorithm, which has been written in GCC language. The microcontroller takes the filtered input signals and calculates precise timing window for generating output signals. The third circuit consists of the NAND gate, which logically multiplies PWM carrier with computed output enable signal what results in switching drive signal.

The drive signal is transmitted to the two-stage transistor output power amplifier. The first amplifying stage is built on a simple BC547 NPN transistor, which provides proper MOSFET gate saturation. In the second stage, the IRF540 N-channel MOSFET transistor for efficient and precise switching of the solenoid valve has been used. The most important IRF540 parameters have been listed in the Tab. 1. If driven correctly, the MOSFET provides high-current sink, which actuates the solenoid in the MultiAir's high-pressure oil valve chamber. According to the measurements, the chamber's solenoid should be powered with a voltage resulting with at least 8 A current per valve. The needed voltage strongly depends on the power cables length and cross-section.

Tab. 1. Electric parameters of the IRF540 power MOSFET transistor

Parameter	Value	Unit
Drain-Source Voltage	100	V
Continuous Drain Current	20	A
Pulsed Drain Current	110	
Drain-Source On-State Resistance	0.077	$\Omega$
Turn-On Delay Time	11	ns
Turn-Off Delay Time	53	

The algorithm for controlling the Fiat MultiAir variable valve actuation needs only two signals for operation, i.e. crankshaft Hall effect sensor output for determining the angular position of the engine's crank, and the exhaust camshaft position sensor output in order to get the TDC position of the piston. The algorithm constantly measures elapsed time between two following teeth on the 60-2 tooth wheel (Fig. 6) basing on the crankshaft Hall sensor and in addition counts the number of detected teeth in form of separate events. The measured elapsed time value is stored in the microcontroller's RAM and is compared with a previous value. If there is no gap condition fulfilled, that is when the measured elapsed time value is not at least twice as the stored value, the newly stored value overwrites the old one and the cycle repeats. However, if the gap condition is met, so the gap occurs, the microcontroller interprets it and resets the event counter. With this kind of event-based approach, one can freely activate and deactivate the solenoid valve on any counted event (tooth). This enables to take a full control of the engine's intake valves behaviour and thus to recreate the exact operation of the MultiAir system. The algorithm is also robust on the engine stop condition. If such state occurs, the timer used for counting elapsed tooth time overflows and triggers an interrupt vector, which resets the whole device putting it in the stand-by mode.

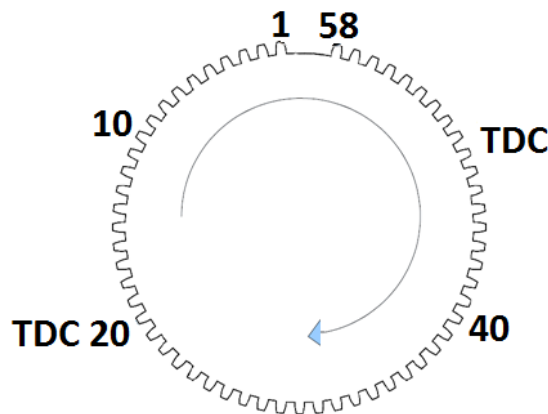

Fig. 6. Tooth wheel with two missing teeth

Assembled device has been presented on the Fig. 7.

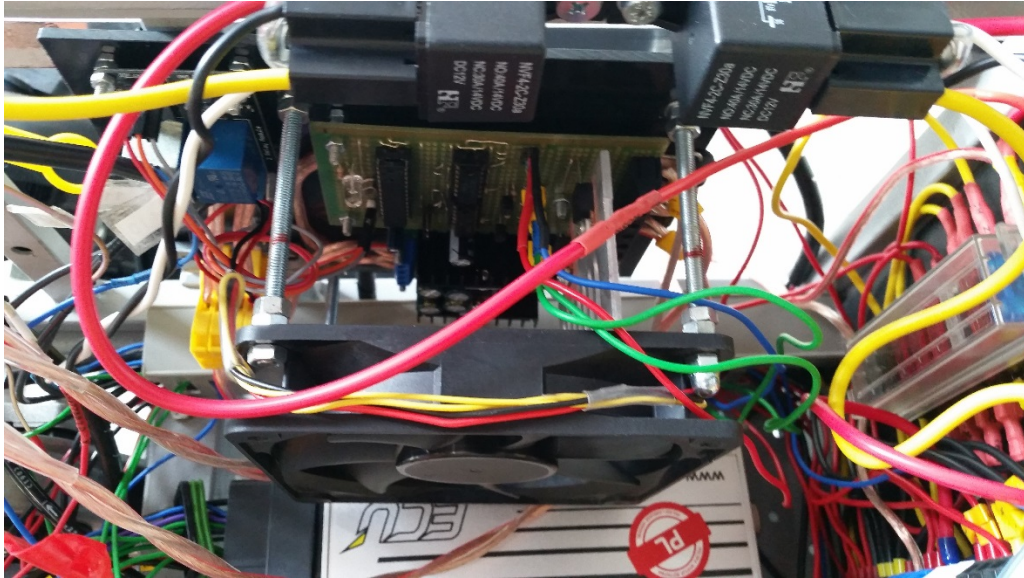

Fig. 7. External device for the Fiat MultiAir valve-lift system control

#### 4. Experimental results

In order to confirm the moments of closing and opening of the MultiAir solenoid valves the series of tests on the original Fiat motor controller have been performed. Fig. 8 shows the signals acquired from one of the combustion chamber for full load (FL mode) and the minimal load (10 Nm) of the engine (LIVO mode) respectively. These signals are: ignition coil current, hall sensor voltage of the tooth wheel (inversed polarisation) and the MultiAir output voltage of the original Fiat motor controller (inversed polarisation). All of the measurements have been performed for 1 500 rpm. Comparing the control MultiAir voltage on the Fig. 8a with the same voltage on the Fig. 8b one can notice a distinct difference resulting in different inlet valve opening and closing angle.

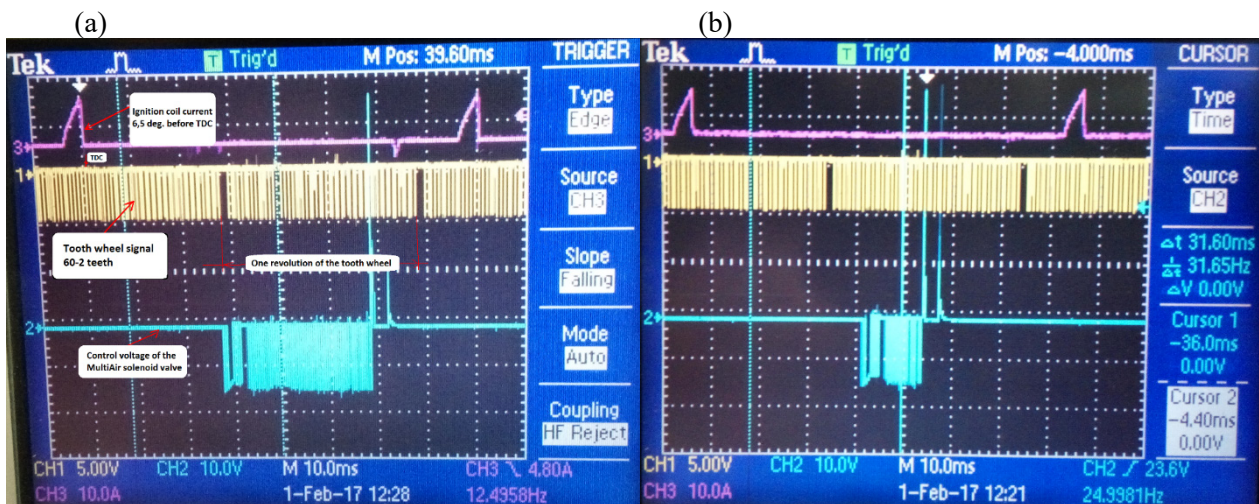

Fig. 8. Signals measured on the original Fiat motor controller for the full load (a) and the minimal load (b) of the engine

The original control signal of the Fiat MultiAir system is the PWM voltage of about 12 V of amplitude and about 31.65 kHz of frequency (Fig. 9). High frequency of the signal is due to the low resistance of the solenoids valves and though necessity of the current limitation and the power consumption reduction. The PWM factor is equal to about 18.5% what gives about 2.2 V of resulting DC voltage.



Fig. 9. Control voltage of the Fiat MultiAir system

Figure 10 shows the resulting signals (CH1\_IRF and CH2\_IRF) from the designed external MultiAir device, which is triggering the DC converter by the two transistors in order to actuate the solenoid valves of the two combustion chambers. Presented oscillogram corresponds to the LIVO mode used for minimal load conditions or idling. The studied Fiat 0.9 TwinAir CNG 80 HP engine works correctly, what confirms a right synchronization of the MultiAir control signals with the signals from the shaft (tooth wheel) and the cam sensors.

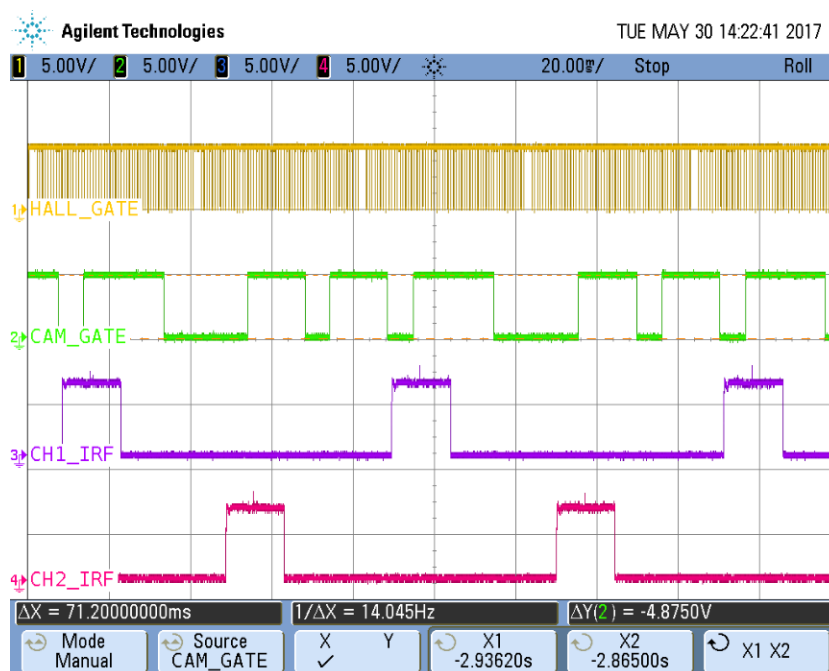

Fig. 10. Signals from the designed external MultiAir device

## 5. Conclusion

In the article, the external device for the Fiat MultiAir valve-lift system control has been presented. The designed device allows precise control of the inlet valve open and close angle according to the engine actual load and speed. Thanks to that, there is a possibility to test other

inlet valves control procedures, which have not been yet investigated by Fiat manufacturer. The external MultiAir controller has been implemented to control hydraulic valve-lift system in the Fiat 0.9 TwinAir CNG 80 HP internal combustion engine controlled by the ECU Master open motor controller. Implementation of the device for other hydraulic valve-lift systems needs further studies. For the moment, the device has been tested only for the minimal load conditions and idling. Further research will focus on the load conditions monitoring based on the generating unit electric parameters measurements. They will also include an instant modulation of the inlet valves open and close angle according to the condition monitoring system information.

## Acknowledgement

*We would like to thank the BOSMAL Automotive Research & Development Institute Ltd for their useful help with the original Fiat motor controller tests. We also thank Tomasz Danilewicz for his valuable help with the laboratory stand construction and graphics preparation.*

*Results presented in the article have been gained within the realisation of the project no. NN 509 292935.*

## References

- [1] Michna, M., Kutt, F., Racewicz, S., Ronkowski, M., *Nonlinear model of synchronous generator for autonomous electrical power systems analysis*, in *2014 IEEE 23rd International Symposium on Industrial Electronics (ISIE)*, pp. 853-858, 2014.
- [2] Kutt, F., Michna, M., Kostro, G., Sienkiewicz, Ł., *Performance and stability of the powers system supplied from batteries and generators in more electric aircraft*, No. 1, pp. 2-4.
- [3] Racewicz, S., Olejnik, A., *Feasibility study of the electric power generation unit start-up using the three-phase synchronous generator with the ac exciter*, *Journal of KONES Powertrain Transport*, Vol. 23, No. 3, pp. 411-417, 2016.
- [4] Zharkov, M. A., Kharitonov, S. A., Simin, V. S., *Electric starter mode three-stage synchronous generator with damping cage*, *Int. Conf. Young Spec. Micro/Nanotechnologies Electron Devices, EDM*, pp. 444-446, 2014.
- [5] Possidente, R., Roselli, C., Sasso, M., Sibilio, S., *Experimental analysis of micro-cogeneration units based on reciprocating internal combustion engine*, *Energy Build.*, Vol. 38, No. 12, pp. 1417-1422, 2006.
- [6] Bernard, L., Ferrari, A., Micelli, D., Perotto, A., Rinolfi, R., Vattaneo, F., *Electro-hydraulic Valve Control with MultiAir Technology*, *ATZautotechnology*, Vol. 9, No. 6, pp. 32-37, 2009.
- [7] Ambrozik, A., Ambrozik, T., *Conversion of fiat 0 . 9 multiair engine to multi-fuelling*, Vol. 20, No. 4, pp. 9-16, 2013.
- [8] Mydłowski, T., Nader, S., Biskup, K., Jasiński, M., *Wykorzystanie urządzenia ECU Master EMU do sterowania silnikami z zapłonem iskrowym*, *Zesz. Nauk. Inst. Pojazdów / Politech. Warsz.*, Z. 5/86, 2011.