

Halil KAVAK^{*}, Ires ISKENDER^{**}, Amir JAHI^{***}

CONDUCTED EMI PERFORMANCE COMPARISON OF SI AND SIC MOSFETS IN A CCM BOOST PFC CONVERTER FOR MIL-STD-461F CE102

This paper presents a comparison of conducted EMI performance of Si and SiC MOSFETs in a CCM PFC boost converter that is designed to meet CE102 of MIL-STD-461F. EMI performance comparison is based on MOSFET of the PFC converter. That is, the power switch of the converter is the only parameter that is changed during tests. The boost diode is kept the same during the tests and the type of the boost diode is SiC. The paper shows the CE102 test results of Si and SiC MOSFETs without an EMI filter at the input side of CCM PFC boost converter.

KEYWORDS: CCM Boost converter, silicon, silicon carbide, conducted EMI, CE102.

1. INTRODUCTION

Power switches that are used in power converters are crucial in the senses of efficiency, EMI performance, size of the converter. As the power switch technology advances, the switching frequency of the converters is increased so that size of the passive components is reduced [1]. Moreover, the efficient switch use in the converter reduced the size of heat sink that results in more reduction in the converter size [1]. However, in military applications, the reliability of the converter overcomes the size and efficiency. Since the reliability of the converter is a critical issue in military applications, the use of the component that is tested many times and many years in the field is preferred over new and efficient component. Therefore, military applications follow the footsteps of the industry.

SiC and GaN power devices are introduced to increase both the switching frequency and efficiency of the converters. Increase in the switching frequency and efficiency results in reduction of size of the converter. These benefits of SiC and GaN devices make these switches favorable power switches in power converter applications. These benefits are presented in many papers [2, 3, 4]. The use of SiC devices increase the efficiency and reduce the size of passive compo-

^{*} ASELSAN Inc.

^{**} Çankaya University

^{***} Gazi University

nents (by increasing switching frequency). Since the EMI filters are made up of passive components, the SiC devices are beneficial for EMI filter requirements of military applications.

According to [5], the use of SiC MOSFETs is mentioned as resulting in better EMI performance along with aforementioned benefits. As it is presented that the EMI performance of SiC MOSFETs is better than that of Si, the question arises that whether this better performance of the SiC is sufficient to prefer SiC over Si just based on conducted EMI performance.

The aim of this paper is to discuss the EMI performance of Si and SiC MOSFETs (the diode is SiC diode) based on the test results of CCM PFC boost converter. The tests are based on CE102 of MIL-STD-461F. The results are presented in experimental results section.

2. EXPERIMENTAL SETUP AND CCM PFC BOOST CONVERTER CIRCUIT

The CCM PFC boost converter circuit is given in Figure 1 and the tested hardware is given in Figure 2. For conducted EMI performance comparison of Si and SiC devices are soldered into the hardware in place of TR101. During CE102 test of the Si power switch based converter, IPW60R041C6 [6] MOSFET of Infineon is soldered. During C102 test of SiC power switch, CMF20120D [7] of CREE is soldered. Except for the MOSFET switch, all the components and test conditions are kept the same.

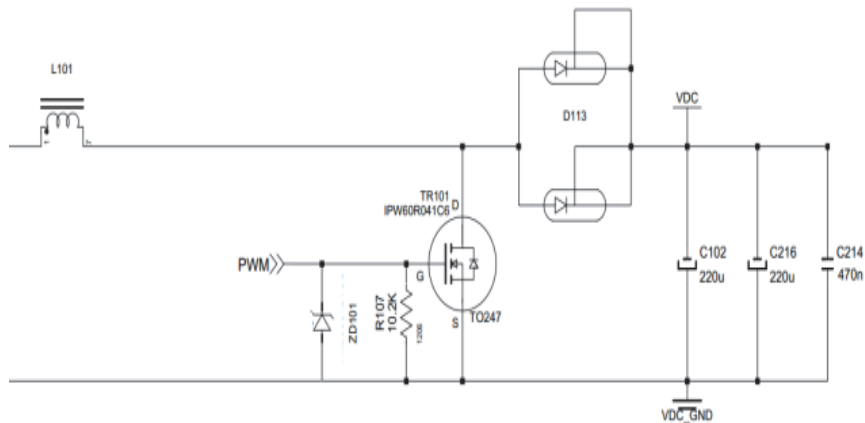

Fig. 1. CCM PFC Boost Converter

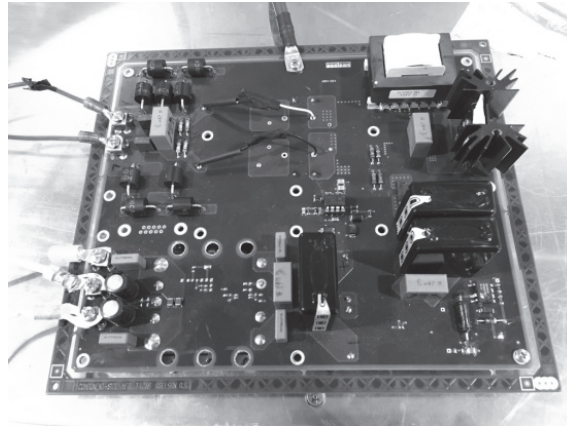

Fig. 2. Tested Hardware

The test conditions are given in Table 1. The test conditions for Si and SiC MOSFET is the same. Only parameter changed during test is the MOSFET switch type.

Table 1. Measurements.

Lp.	V _{in}	V _{out}	P _{out}	Switching Frequency
	VAC	VDC	W	kHZ
IPW60R041C6	115	48	240	100
CMF20120	115	48	240	100

Conducted EMI test for CE102 of MIL-STD-461F covers the frequency range of 10 kHz-10 MHz. The converter is operated from the nominal input voltage of 115 VAC and the output of PFC converter is loaded with a DC-DC converter whose output is 48VDC. The DC-DC converter output is loaded with an electronic load up to 240 W.

Based on aforementioned conditions the CE102 test is applied to converter for the two MOSFETS.

3. EXPERIMENTAL RESULTS

The test results are given in the figures 3-12. The figures show the conducted EMI level of converters for Si MOSFET and SiC MOSFET at the same time. The frequency range of CE 102 is divided into frequency ranges to increase the visibility. The red line in the figures is the limit of CE102 given in MIL-STD-461F.

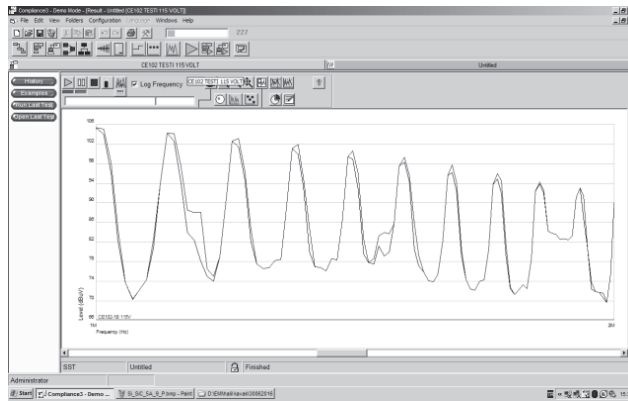

Fig. 3. Si (Brown), SiC (Black) Conducted EMI, 1-2 MHz Range

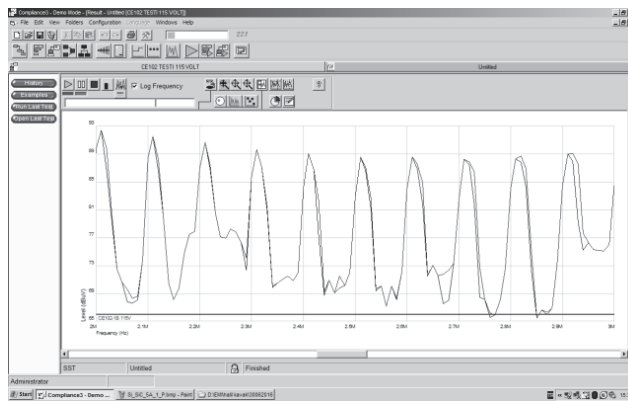

Fig. 4. Si (Brown), SiC (Black) Conducted EMI, 2-3 MHz Range

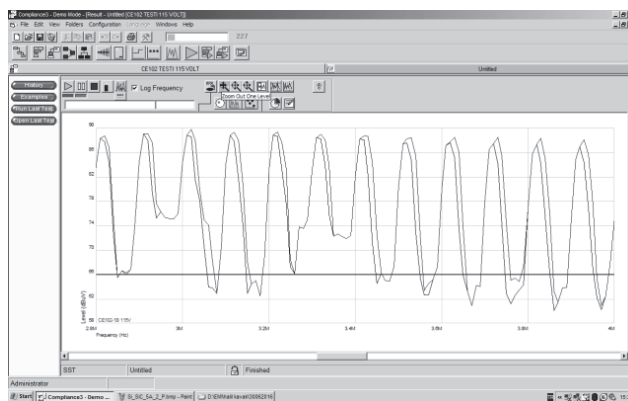

Fig. 5. Si (Brown), SiC (Black) Conducted EMI, 3-4 MHz Range

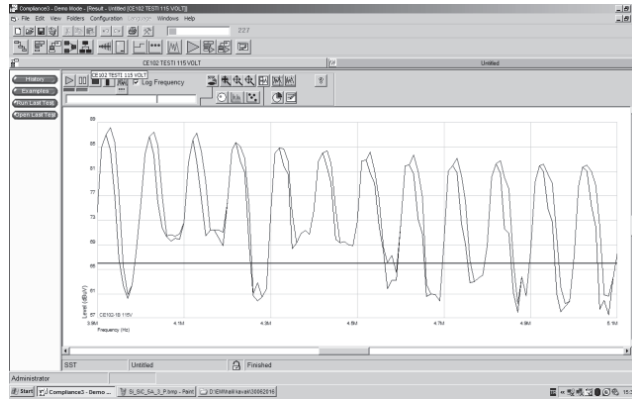

Fig. 6. Si (Brown), SiC (Black) Conducted EMI, 4-5 MHz Range

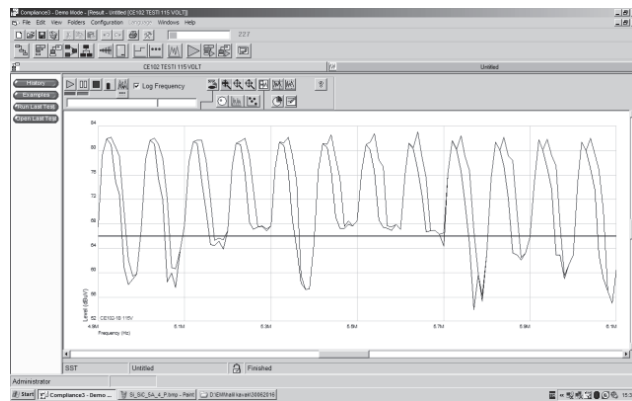

Fig. 7. Si (Brown), SiC (Black) Conducted EMI, 5-6 MHz Range

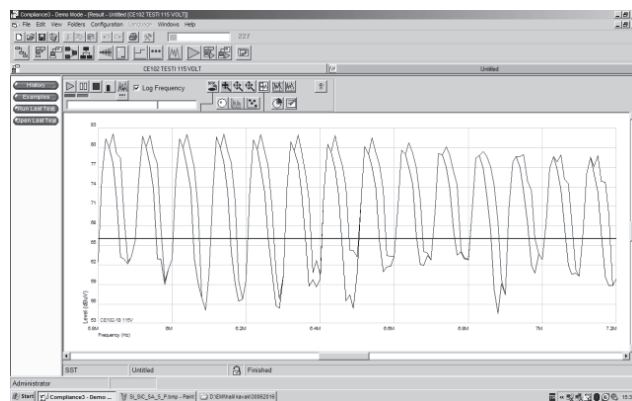

Fig. 8. Si (Brown), SiC (Black) Conducted EMI, 6-7 MHz Range

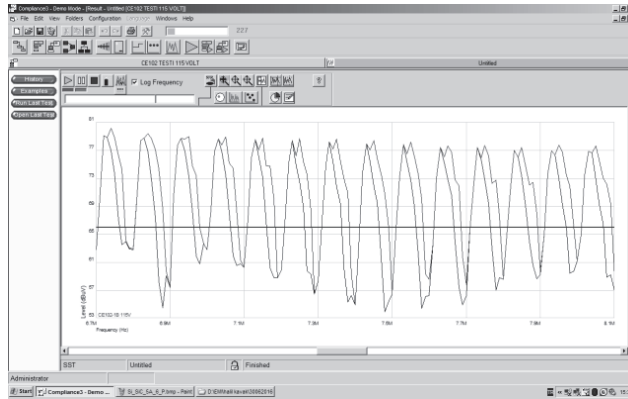

Fig. 9. Si (Brown), SiC (Black) Conducted EMI, 7-8 MHz Range

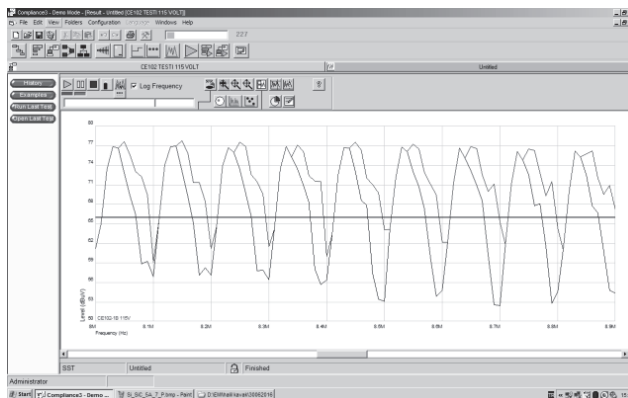

Fig. 10. Si (Brown), SiC (Black) Conducted EMI, 8-9 MHz Range

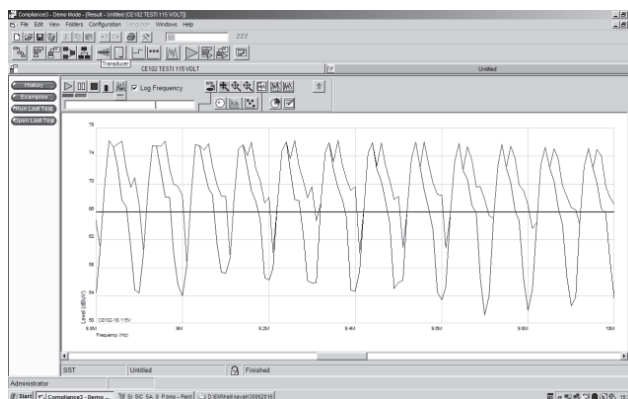

Fig. 11. Si (Brown), SiC (Black) Conducted EMI, 9-10 MHz Range

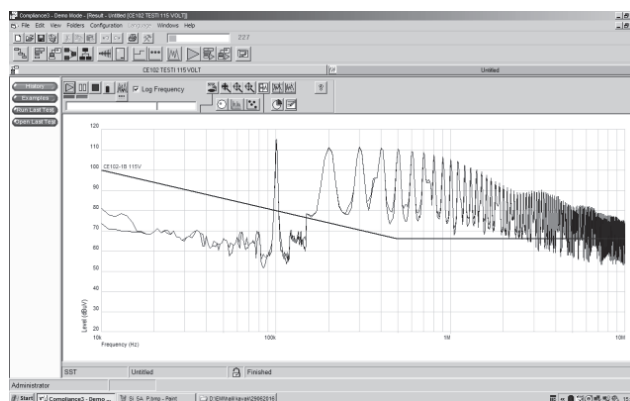

Fig. 12. Si (Brown), SiC (Black) Conducted EMI, 10 kHz-10 MHz Range

4. CONCLUSIONS

The test results for CE102 tests of Si MOSFET and SiC MOSFET show that there is not a significant difference of conducted EMI between Si and SiC MOSFETs in the range of 10 kHz to 10 MHz. It is also clear from the results that SiC MOSFET is superior to Si MOSFET in terms of conducted EMI in the given range of frequency. However, this superiority is almost negligible for the given frequency range. As the results in [5] and in this paper are considered together, the diode reverse recovery is the key factor that decides on the EMI performance.

The results show that using SiC MOSFETs in CCM PFC boost converter instead of Si MOSFET just based on conducted EMI performance should not be the only preference criteria. The efficiency, high frequency operation and high die temperature should also be taken into account.

When the comparably high price of SiC devices as compared to Si devices is taken into account, the device technology that is going to be employed in the CCM PFC boost converter should not be only based on conducted EMI performance.

REFERENCES

- [1] Albanna A., Malburg A., Anwar M., Guta A., Tiwari N., Performance Comparison and Device Analysis Between Si IGBT and SiC MOSFET, Transportation Electrification Conference and Expo (ITEC), IEE, 2016.
- [2] Fujihira T., Fujishima N., Kimura H. and et al., Impact of SiC on Power Supplies and Drives to Save Energy and Materials, PCIM Asia 2017, 27 – 29 June 2017, Shanghai, China.

- [3] Kostov K., Rabkowski J., Nee H.P., Conducted EMI from SiC BJT Boost Converter and its Dependence on the Output Voltage, Current, and Heatsink Connection, ECCE Asia Downunder (ECCE Asia), IEE, 2013.
- [4] Stevanovic L.D., Matocha K.S., et al., Recent Advances in Silicon Carbide MOSFET Power Devices, Applied Power Electronics Conference and Exposition (APEC), Twenty-Fifth Annual IEE, 2010.
- [5] Franco P.B., Sendra J.B., EMI comparison between Si and SiC technology in a boost converter, Electromagnetic Compatibility International Symposium(EMC EUROPE), 2012.
- [6] 600 V CoolMOSTM C6 Power Transistor IPW60R041C6 Datasheet, Rev.2.1, 2010-07-12.
- [7] CMF20120D-Silicon Carbide Power MOSFET, CMF20120D Rev. D.

(Received: 30.01.2018, revised: 10.03.2018)