

Integrated mathematical model of competence-based learning-teaching process

P. RÓŻEWSKI^{1*} and O. ZAIKIN²

¹ Faculty of Computer Science and Information Systems, West Pomeranian University of Technology in Szczecin, 49 Żołnierska St., 71-210 Szczecin, Poland

² Warsaw School of Computer Science, 17 Lewartowskiego St., 00-169 Warsaw, Poland

Abstract. The competence-based learning-teaching process is a significant approach to the didactical process organization. In this paper the mathematical model of the competence-based learning-teaching process is proposed. The model integrates three models: a knowledge representation model (based on the ontological approach), a motivation model (as a behavioral-incentive model) and a servicing model (in a form of the queuing model). The proposed integrated model allows to control the learning-teaching process on different levels of management. The learning-teaching process can be interpreted as competence-based due to Open and Distance Learning (ODL) philosophy. We assume that the competence is a result of fundamental, procedural and project knowledge acquisition in accordance to the incoming European Qualification Framework.

Key words: competence-based learning, incentive mechanism, control in social-economic systems, queuing theory, competence models.

1. Introduction

In the history of modern electronic market the knowledge management paradigm is changing and the realization of value through a prudent application of knowledge has been given importance over simple acquisition, development, storage, use and ownership of concepts and facts [1]. Hessami and Moore [1] prove that this is broadly referred to competence which in a systems paradigm, involves a greatly more than knowledge alone. The competence management can help with answering questions related to a successful job performance and company development [2]. A large number of literature provides description of competence-based management (e.g. [3]), which in generalization can be seen as management of human capital [4].

The motivation for the research was a new accent that has been placed in the Bologna Process on the competences and qualifications framework [5]. The main purpose of it was to create the Qualifications Framework of the European Higher Education Area (EHEA): universal system to translate National Qualification Framework (NQF) across European countries. This way, workers and students in European Union gain more mobility between countries allowing them to study or work abroad without the difficulties of complicated analysis of their current competencies, knowledge and skills [6]. The NQF is designed for each separate university competence management system. That is the reason why special attention should be paid to maintain university framework for competence management [7].

We have analyzed the learning-teaching process in the context of Open and Distance Learning (ODL) philosophy [8]. The distance aspect defines the educational situation in which the student can be far away, in terms of distance, from the

didactic materials and the different participants of the learning process [9]. The openness aspect of the ODL process is visible in the strategy and policy that underlies the approach. Each user is eligible to have the possibility to rather freely choose the material he/she will learn, and the place of study (e.g. Bologna Process).

The competence-based learning-teaching (CBLT) process differs from classical topic-based learning. The competence-based (or competence-driven) learning is a knowledge based methodology which concentrates on measuring what a person can actually do as a result of learning [10]. It contrasts to classical topic-based learning where certain topics are learned and then it is checked whether the student can solve exercises or knows the theory relevant to that topic [10]. In CBLT based on the assessment of learner's competence positioning, the individual trainings and learning paths can be developed to support the learner's development [11]. One of the important characteristics of CBLT process is that the students' autonomy and ability to learn how to learn is steadily developed [12]. Moreover, the ability to learn become main competence in rapidly changing world.

In the modern educational organization, especially on the university level, the relation between teacher and students and the learning-teaching process itself are evaluated. The principal (teacher) and the agents (students) have their own interests, which are reflected by their strategies. The teacher is aimed to transfer the knowledge to the student, following the learning objectives, in order to achieve some level of competence by the student. Moreover, the teacher is obligated to develop the didactic material in the university knowledge repository [13]. The knowledge development paradigm is changing and the main idea is to include students in the repository develop-

*e-mail: prozewski@wi.zut.edu.pl

ment process [12]. On one hand, students can expand their knowledge in an active-based learning process, on the other hand, students can record their achievements relying on a market located e-portfolio mechanism. Due to expectations of students and their potential employers regarding the learning outcomes and effectiveness of the learning process, the competence-based learning-teaching seems to be a new form of learning-teaching process organization. The main elements of new learning-teaching process are [13]:

- model of a learning process based on competence transfer,
- a digital repository with high quality didactical material,
- e-portfolio for storing student achievements,
- general recognized competencies record.

We can recognize learning-teaching situations as an instance of socio-technical system, which can be treated as an incentive models. There is a number of practical implementation of the incentive models [14]. One of them is learning-teaching process based on distance learning technology developed for competence acquisition. Generally speaking, the incentive models are a case of active system, which consists of principal (in our case teacher) and agents (in our case students) [15]. In the literature the incentive problem was formulated in a following way [16]: find feasible control variables (incentive function), which will induce the agent to undertake actions, which are the most preferable from principal's point of view. We assume that in modern educational organization the learning-teaching process works in accordance with the concept of control of incentive models [17]. In this process, the teacher tries to convince his students to acquire a specific body of knowledge through appropriate arrangement of tasks to be solved and ratings (rewards) for their solution. Tasks are available through the mechanism of knowledge repository.

In the paper, the integrated mathematical model of competence-based learning-teaching process is proposed. The problem has been already analyzed from social side and the model of an educational social agent collaboration between students, teacher, and an e-learning information system (repository) was proposed [13]. In a supplementary paper, the learning-teaching process was treated as an intangible production maintained by educational organization [18, 19], where the production process utilizes different types of knowledge as semi-products and competence is the final product. In addition, the motivation model aimed at supporting activity of both students and teachers in the process of implementing and using an open and distance learning system was developed [20]. This paper sum up all proposed approaches in form of integrated mathematical model.

The paper has following structure. In the next section the literature review related to the competence modelling topic will be presented. After that, in section three, the learning-teaching process model will be decomposed. In section four the main characteristics of the competence-based learning-teaching are discussed. Section five is the most important part of the article. Three models (knowledge representation, behavioral and servicing) are formulated. The models are incorporated into integrated mathematical model of competence-

based learning-teaching process. The article ends with conclusion and references.

In the article the identification problem is not a focus point. The discussed research covers the issue of interpretation of teaching-learning process in the framework of ontological models, behavioral model and servicing model.

2. Literature review

The issue of competence-based learning-teaching was analysed in various projects. Let's chronological discussed this issues in European projects framework, because it's influenced the current shape of the European Qualification Framework [21]. Moreover, we focused on the European project due to their maturity and an outstanding, challenging multicultural nature and complex structure of the European Higher Education Area.

One of the first contributions to the problem of competence-based learning-teaching came from the open platforms and tools for personalized learning analysed by the project 'KOD: Knowledge on Demand' (2000–2003) [22]. According to the project's documentation the aim of the project was to design, develop and test the learning environment, as a dynamic and adaptable on-line environment which allows the individual learner to acquire knowledge according to his/her personal learning needs. The project's result related proper personalized learning on-line environment with actual student competence profile. The project 'TenCompetence: Building the European network for lifelong competence development' (2005–2009) [23] focused on the competence-based approach to lifelong learning. In this framework we considered all the informal and experiential learning that an individual acquires during the course of his or her lifetime rather than focusing solely on academic or theoretical achievement. The most important goal of the project was provided the answers, based on the Personal Competence Manager, for individuals needs like [24]:

- keep up to date with developments in their field of expertise,
- reflect on their current competences in order to know which functions or jobs are within their reach,
- improve their proficiency level of a specific competence,
- support on-trivial learning problems,
- explore the possibility in a new field (learning network) to help define new learning goals.

The TenCompetence project developed the Personal Competence Manager, where user has access to tools for organizing participation and authoring of competence development programmers [24]. The open and common acceptable workspace for competence development was a next important result in the competence modelling domain.

Interesting dimensions of multicultural competencies aspects in European region came from project 'QUALITY: Quality Implementation in open and distance learning in a multicultural European environment, (2003–2006) [25]. The project related to the European Qualification Framework are

important factor in progress of competence development. These projects can be found on ADAM Leonardo da Vinci portal [26]. Most of them provided competence development support for selected domain (like tourism, fashion, ecology, ...) with some exceptions. The project 'ICOPER: Interoperable Content for Performance in Competency-driven Society' (2008–2011) [27] collects and further develops best practices for higher education tackling issues like creating learning designs and teaching methods, authoring content for reuse, transferring knowledge in an outcome-oriented way and assessing it, or evaluating learning activities. The project 'eCO-TOOL: eCOmpetences TOOLS' (2009–2011) [28] developed European skills and competence model that can be integrated in the existing European policies (namely Europass, EQF, EQAVET, ECTS, and ECVET) and adapted to all branches.

All presented projects provides interesting conceptual schemes and tools for supporting competence-based learning-teaching process, however lacking some formal approach to problem of competence modelling in learning-teaching process. The achieved level of conceptualization, concerning the determination of the existence of data objects and relationship between them, allows to develop XML schemas at most.

In addition to the work related to modeling of competence-based learning-teaching process there are ongoing work on the development of competencies format. In the literature the most important approach to competence modeling based on ontology concept. The ontology-based approach was chosen mainly because we want to structure the domain rather than the quantitative relationship between the parts of competence model. The ontology helps structured and utilized the competence profiles in a competence management system [29]. Ontology represented in Description Logics is a base for automated knowledge-based services. In [30] we can find an integrated semantic-based knowledge management system providing decision support services for several activities typical of competence management, including core competence evaluation, human resources allocation, training programs planning. In addition ontology based tool for competency management allows to develop and maintain individuals learning paths [31].

The learning-teaching process is also considered from mathematical psychology point of view. The mathematical learning theory is mainly developed in the neuroscience field. In this approach the mathematical model of learning posited a central role for an abstract cognitive representation distinct from the stimulus or the response [32]. The memory models are limited by several neuroscientific results. Other perspective to mathematical interpretation of learning-teaching process is a ARCS (attention, relevance, confidence, satisfaction) model [33]. Developed ARCS model and related integrative theory of Motivation, Volition, and Performance (MVP) [34] provided empirical support for the statistical analysis of elements included in process. In addition important results are coming from cognitive informatics. The learning-teaching is based on neural informatics foundations especially hierarchical neural cluster (HNC) model and the object-attribute-relation model [35]. The cognitive processes of learning can

be formally described using real-time process algebra [36].

The presented mathematical-rooted models are missing the relation with system layer and the mathematical formula are developed on low neuroscience or cognitive informatics level. Such granularity is inconvenient for management problem modelling.

3. General structure of the learning-teaching process

The competence-based approach offers the possibility to examine the education process in the two: teaching and learning viewpoints [8]. The main objective for an education institution is to merge the two subsequent processes of teaching and learning into one consistent knowledge-driven learning-teaching process. In Fig. 1 the learning-teaching process is presented. The process can be interpreted as a competence-based student's life cycle. On the Fig. 1 three levels have been isolated to enable controlling and steering of knowledge transfer and acquisition (see Table 1). Knowledge characteristics vary depending on the stage of the learning process. In this proposal competence is not considered as a monolithic model, it is formed from a consistent set of knowledge models addressing and encompassing several education activity objectives.

From the perspective of competence the learning-teaching process can be presented as a learning cycles (A, B, C, D in Fig. 1). Each loop is developed to acquire some component of competence. Moreover, turning to the next cycle is conditional and depends on the achieved results of student's education. The adaptation operation provides the possibility to adapt the reference knowledge to real education situation. The students are identified (in some cases considered as a group) and the didactic material is personalized. The final stage is to making the didactic resources (teacher's consultation time, virtual laboratories, etc.) accessible for students.

In Fig. 1. feedback loops (A, B, C, D) characterizing the real learning activities within the contingent of students. The proposed approach includes divergence of the knowledge processed, according to the courses' subject and their specifics [8]. Therefore, four learning-teaching process loops (feedback) have been outlined. Each of the loops is devoted to different purposes and distinct characteristics. These are the following:

A. student's base knowledge analysis: the Teacher validates the student's level of qualifications (competences) in a given domain,

B. the theoretical knowledge absorption (learning): the teacher transfers abstract knowledge of the domain of discourse, enabling the student's to master and use abstract, and reason within the given knowledge system,

C. the procedural knowledge edification: the teaching is focused on software (tools) use, the comprehension of particular computer-supported simulation areas' (environments') functioning (the comprehension of the applied metaphors),

D. the project (application) of absorbed knowledge in a real situation: the aim of this stage is to apply the acquired

knowledge (stages B, C) in a concrete, real event. The student is expected to classify the given task, which are to be solved, efficiently and skillfully refer to his/her own cognitive schemes, and he/she has to apply the appropriate tool. The process is finished by obtaining a results analysis and producing conclusions.

The final mechanism of the entire learning process validation is the process of diploma formation and development. The diploma thesis consists of knowledge acquired by the student during the entire learning process execution and reflects his/her competencies.

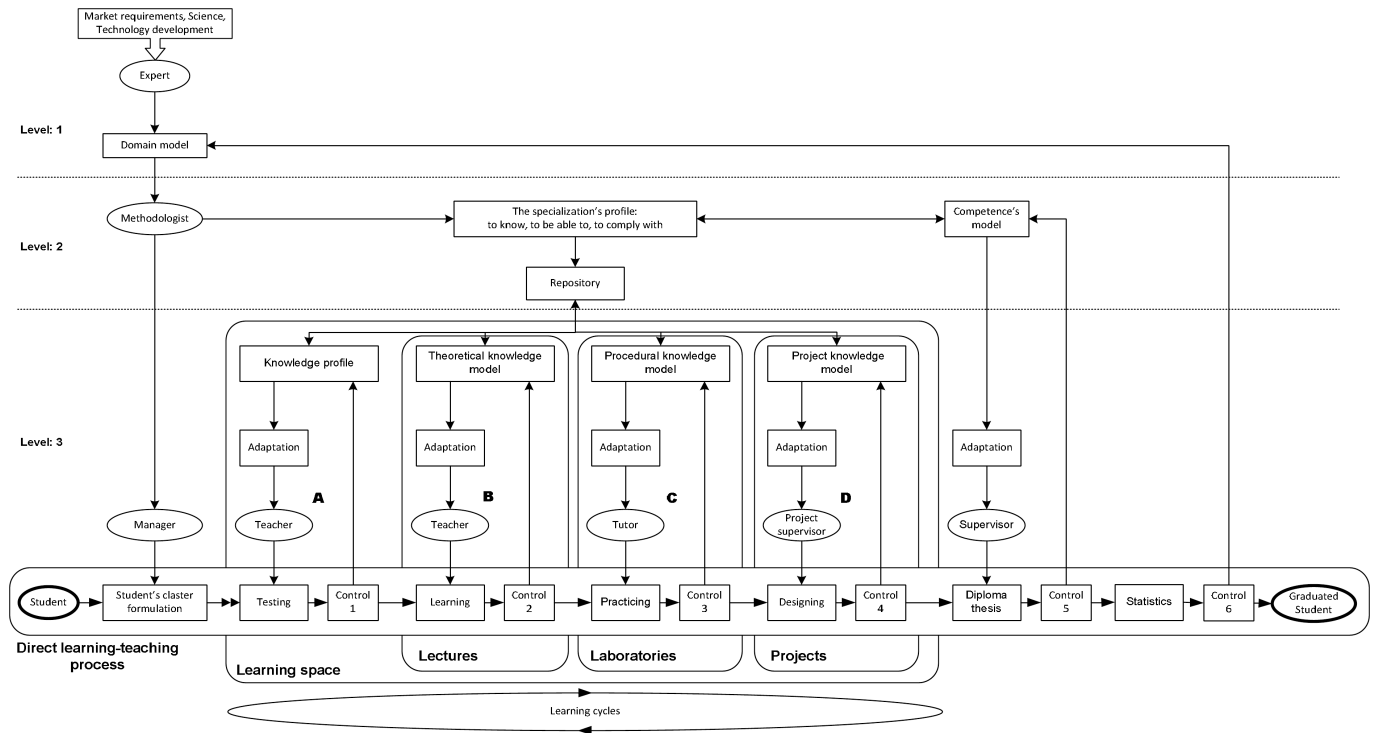

Fig. 1. The structure of learning-teaching process (adapted from Ref. 8)

Table 1
Main characteristics of learning-teaching process

No.	Level's name on Fig. 1	Main activity	Main outcomes	Main constrains	Validation
1	Expert's level	Analysis of innovation in market, science, etc. supports within the learning process	Domain model: reflects the labour market situation, recognition, and identification of the current state of science and domain knowledge in given area	Domain model should represents knowledge required at a requested learning-teaching time interval.	The model's validity and timeliness is interpreted as the difference between knowledge gain inherent to the domain and knowledge model which is enclosed in the student's profile.
2	Competence model level	Planning of the learning-teaching process strategy	Competence model: represents the expected structure of student's knowledge and skills Repository: consists of didactical materials for lecture, exercise, laboratory and project courses	Current organization's practical constrains, mission and strategic goals.	In order to validate the repository we have to check how the repository content reflects the domain?
3	Learning-teaching level	Didactic materials content formulation adaptation, preparation of material for student contingent	Learning space, content for lectures, laboratories, and projects.	Cognitive characteristics of students, technical limitations of learning environment	There are a number of validation (control 1, 2, 3, 4 on Fig. 1) during the learning teaching process. The final validation is a diploma thesis (control 5 on Fig. 1).

4. Competence-based learning-teaching process

4.1. Competency definition. The competence is defined in many scientific works [3, 37, 38]. Chiesa and Manzini [39] proposed following reasons for this redundancy: often use different terminology for similar concepts; appear to refer to inherently different levels of activities within organizations; generally adopt a static view of competences that does not adequately consider how competences are built or can be changed within an organization.

Let's define a competence definition based on the well-known standards. ISO 9000:2005 defines competence as the 'demonstrated ability to apply knowledge and skills'. According to the HR-XML Consortium [40], a competency can be defined as 'A specific, identifiable, definable, and measurable knowledge, skill, ability and/or other deployment-related characteristic (e.g. attitude, behaviour, physical ability) which a human resource may possess and which is necessary for, or material to, the performance of an activity within a specific business context'. ISO 19011 defines competence as 'demonstrated personal attributes and demonstrated ability to apply knowledge and skills'. ISO/IEC 17021:2011 defines competence as 'ability to apply knowledge and skills to achieve intended results'. IEEE Standard 1484.20.1-2007 describes competency as 'any aspect of competence, such as knowledge, skill, attitude, ability, or learning objective'. In addition, there is a running discussion about difference between competence and competency term [37]. The IEEE Standard 1484.20.1-2007 interpreted the competency in the broadest sense to include learning objectives (those things that are sought) as well as competencies (those things that are achieved).

4.2. The competence acquisition process decomposition.

The proposed learning-teaching process consists of number of learning cycles (B, C, D on Fig. 1), each of which performs processing of didactic materials. We assume that the result of didactic materials processing is increasing of student's competence and new didactic materials development. The developed didactic material is stored in the knowledge repository. The process is student's oriented and has following objectives:

1. transfer a portion of knowledge to the student to have him/her acquire competencies,
2. generate new knowledge and saved it in the repository.

We assume that proper combinations of theoretical, procedural, and project knowledge result in efficient competence acquisition by the student (Fig. 2) [18]. Competence is an ability to find effective way to theoretical knowledge usage in order to solve the practical problem and ability to verified the solutions. The concept of competence is broader than the concept of qualifications. For example ISO 24763 document describes competence as 'demonstrated ability to apply knowledge and skills'. Selected elements (objects) of theoretical knowledge combined with proper objects of procedural and project knowledge creates the basis for competence object. Depending on context skills can be recognized as procedural knowledge and experience and social skills as a project knowl-

edge. The necessity of combining these types of knowledge arises during performance of practical tasks, laboratories and projects.

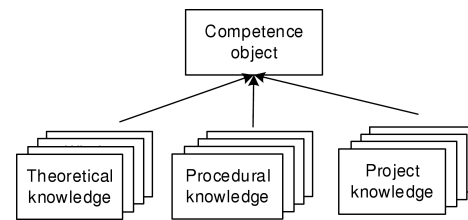

Fig. 2. Structure of competence object (adapted from Ref. 18)

In order to develop the mathematical model we analysed the actions during the loop of learning-teaching process from Fig. 1. The process of transfer of various types of knowledge, which make up the competence, assumes that at the beginning the tasks are downloaded from the repository (Fig. 3). The student can download tasks of different level of complexity. One of the propositions of task's discriminating is the consolidation tasks (easy tasks) and creative tasks (difficult tasks) [41]. The student chooses the task in the selection block. The selection process is based on the motivation model for the student and teacher (presented in [20]). The motivation model belongs to the class of incentive models and is oriented towards maintaining control of social economic systems [15]. The teacher's interest is in maximizing the level of repository filling with tasks of different complexity for every considered educational situation in a given domain taking under consideration process time limitations and student's learning objectives. The student's interest lies in individual preferences and can be described using opposing groups of criterions [8]:

1. achieving a minimal acceptable success level, meaning meeting only the basic requirements for obtaining a positive opinion about the task (low complexity of the task, minimal acceptable quality) and saving maximal amount of their time;
2. providing the repository with the maximal possible success level, implying creating and editing contents of high complexity in order to produce the best overall quality. The best solution can be placed in student's portfolio for future usage [13].

The degree of complexity is not the only factor that affects the teacher's interest in the task selection. As the repository is going outdated, some repository areas need to be redesigned and updated. When the processing of the task is finished the student moves to next portion of knowledge and procedure form Fig. 3 is repeated. The stage of knowledge processing can be finished in the following ways (Fig. 3):

1. finish the task with a positive result of assessment (p_2),
2. return to the task selection block (p_3),
3. exit from the learning system (p_4),
4. finish the task with a positive result of assessment; the task's solution is transferred to the repository, due to the excellence of the student's work, and it is treated as a new organization's knowledge (p_1).

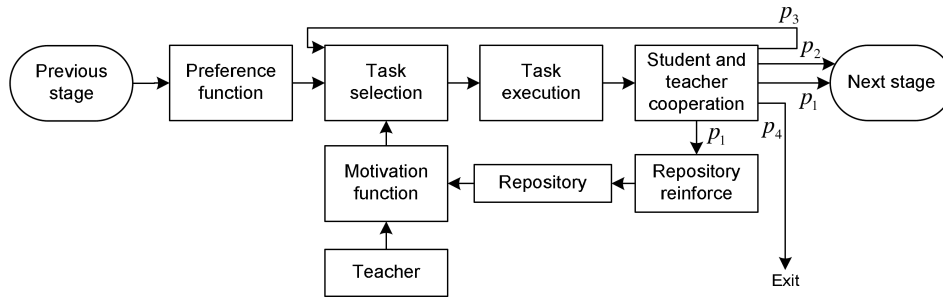

Fig. 3. Structure of the learning system for specific kind of knowledge transfer (adapted from Ref. 19)

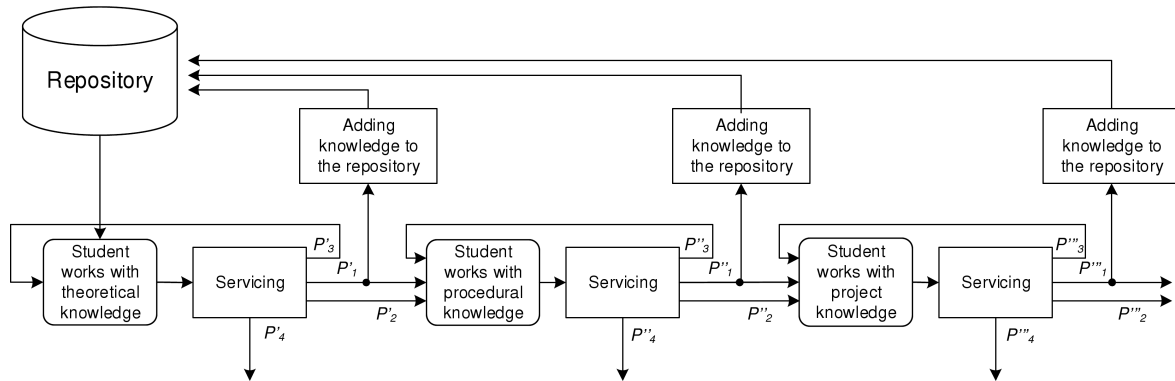

Fig. 4. Structure of the competence-based learning-teaching process (adapted from Ref. 19)

The same procedure is used for theoretical, procedural and project knowledge loop (Fig. 4) as well. In the process of learning-teaching each student's activity is interpreted as a student-teacher collaboration based on didactic materials contained in the repository. The specificity of this cooperation is as follows:

- The didactic material is presented in the form of an ontology divided into appropriate portions of knowledge (Learning Object [42]), each of which covers a range of theoretical, procedural or project knowledge.
- The student uses self-education for knowledge acquisition and cooperation with the teacher for consultation.
- The time of cooperation is limited.

5. Model formulation for single stage of competence-based learning-teaching process

5.1. Formulating the integrated repository filling model.

The analysed process can be modelled in different ways (e.g. discrete-event models) [43]. However, the open aspect of the learning-teaching process has features that demands carefully selected modelling approach. The ODL student can enter the system at any moment. Students' initial levels of knowledge are different and can differ in both the content and the context of possessed knowledge (different educational background). Students' expectations regarding the educational system, their motivation and learning preferences are different as well. The resources of the educational system are limited. In

case of a large amount of students, the students are organised to wait in queues. In consequence, the queuing system is the best approach while modelling the stochastic nature of the servicing aspect of ODL learning-teaching process. Only in the ODL conditions the queuing system approach to the learning-teaching process is valid.

Let's define the integrated repository filling model:

For the given:

Domain D and its ontology graph $G^D = \{W^D, L^D\}$, where W^D is a set of vertices (concepts) and L^D is a set of arcs (relations) of graph;

Characteristics of educational situation:

- Course C and set of competences $\{c_k\}$, $k = 1, \dots, k^*$;
- Participants: teacher N and group of students $S = \{s_j\}$, $j = 1 \dots j^*$;
- Interval of the learning process $[0, T]$,
- Stochastic students' arrival pattern $\pi(s)$ and arrival process parameters $\{\lambda^s, \chi^s\}$, where λ^s is rate of arrival and χ^s is the variance.

Teacher N has to:

a) Create the course ontology model $G^C = \{W^C, K^C\}$, where $W^C \subseteq W^D$, $K^C \subseteq K^D$.

b) Form the set of tasks $R = \{r_i^k\}$ and task parameters: $\Pi = \{q(r_i^k), u(r_i^k)\}$, where $q(r_i^k)$ is a task r_i complexity level and $u(r_i^k)$ is a task's topicality for the teacher.

c) Choose the teacher's motivation function $\sigma^N = \sigma^N(r_i^k)$ regarding repository filling.

d) Define servicing parameters of student workflow:

- Servicing time of each kind of tasks $t^o(r_i^k)$,
- Total amount of resources required for group of students \bar{X}_o .

Student s_j has to:

Choose the task $r_i^k(s_j)$ from set R basing on teacher motivation function σ^N and own preference function $\sigma^S = \sigma^S(r_i^k)$.

Criterion function

Teacher choose properly solved tasks basing on tasks parameters $\Pi = \{q(r_i^k), u(r_i^k)\}$ for filling repository in accordance to the following function

$$G^P = \bigcup_{j=1}^{j^*} G(r_i^k(s_j)) = \text{Max}, \quad (1)$$

where G^P is total knowledge accrual in repository, $G(r_i^k(s_j))$ is ontological graph of task r_i^k , solved by student s_j , $G^W \cap G(r_i^k(s_j)) \neq \emptyset$.

Constraints

a) summary resources (time-related, technical, didactic, staff) offered to students for solving tasks:

$$\bar{X}_o = \sum_{s_j \in S} \bar{x}(r_i^k(s_j))y(r_i^k(s_j)) \leq \bar{X}, \quad (2)$$

where $\bar{x}(r_i^k(s_j))$ – resources appointed to student s_j for solving task r_i^k , $y(r_i^k(s_j)) = \{1, 0\}$ – binary function of choice the task r_i^k by student s_j , \bar{X} – summary resources for the subject lead by the teacher,

b) calendar interval $\tau \in [0, T_0]$, appointed to students for choosing and solving tasks

$$\begin{aligned} \min_j \tau(r_i^k(s_j)) &\geq 0, \\ \max_j \bar{\tau}(r_i^k(s_j)) &\leq T_0, \end{aligned} \quad (3)$$

where $\tau(r_i^k(s_j))$, $\bar{\tau}(r_i^k(s_j))$ - appropriate moments to start and end solving task r_i^k by student s_j .

In order to process different kind of knowledge the information system has to support various aspects of learning-teaching process (e.g. organizational, cognitive, social). As a result of analysis we recognized three mutual related models (Fig. 5), which will allow not only the management of educational material in competence-based learning-teaching process, but also the environment of its submission:

- Knowledge representation model – responsible for the storage and distribution of knowledge related to competence (Strategic level of management).
- Behavioral (incentive) model – responsible for organization of cooperation between the teachers and the students, based on a repository of knowledge (Tactical level of management).
- Servicing model – responsible for managing the competence transfer environment/system on operational level (Operational level of management).

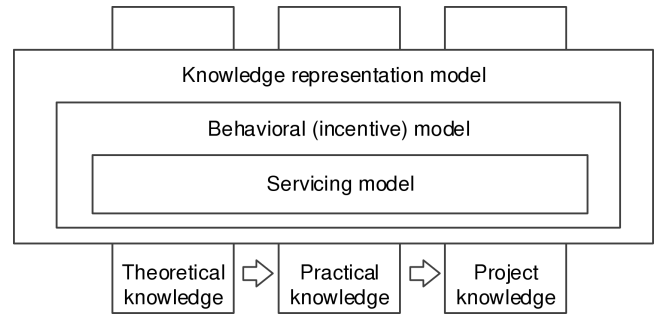

Fig. 5. The relations between different aspects of competence-based learning-teaching process

Three kinds of models correspond to three kinds of management in the learning-teaching process:

1. Institutional management:
 - (a) ontology graph of course and its structure
 - (b) set of tasks and number of simple and hard tasks
 - (c) strategy of repository filling in
2. Behavioral/ Motivation management
 - (a) teacher and student motivation functions
 - (b) criteria and goal functions
 - (c) constraints
3. Servicing management
 - (a) servicing time for different kinds of tasks
 - (b) discipline and priority of servicing

Analysing Fig. 5 we can see two possible dimensions of integration of models. One direction is vertical and the other horizontal. Vertical integration is responsible for the preparation of the environment and horizontal integration responsible for the transfer of didactic material to the student in order to obtain designed portion of knowledge and competence.

The main mechanism for integrating the horizontal and vertical dimensions is the knowledge repository. From the horizontal point of view the repository contains didactic materials for each types of knowledge, required for competence transfer. In terms of vertical dimension the knowledge repository is a place with which every processes and resources are related. Based on the repository the personalized learning process is constructed by defining the structure of the course and its content. Moreover, resources placed in the repository are the tasks of various types and difficulty supporting the acquisition of different types of knowledge. Knowledge increases when students process knowledge from the repository by solving difficult tasks instead of easy one. While the student obtain the same range of competence during the process, the competence level depends on student motivation to work hard and solve more difficult tasks.

In the next step we formulated the knowledge representation model, behavioural (incentive) model and servicing model for single cycle of knowledge transfer. The cycles have the same structure for all types of transferred knowledge (i.e., theoretical, procedural and project), so the results will be transferable.

5.2. Knowledge representation model. The proposed knowledge representation model is based on the ontology approach and is designed in a way to best represent competences [44]. Based on the previous discussion, we assume that the competences are gained by the process of student's acquisition of fundamental, procedural and project knowledge. This assumption may be extended, if necessary, for other types of knowledge. In addition we have to taking into consideration the learning objectives of student.

Structure of the model:

- The knowledge repository and implemented mechanism for different parts of knowledge storing and processing.

Goal of the model:

- Integration of different types of knowledge included in competence and the different manner of its presentation in a single model based on the ontology approach, with further fragmentation of this model into a set of competence portions in the form of Learning Objects.

Set of tasks:

- Developing a method for accumulating various types and fragments of teaching materials, which reflect the declarative (theoretical), procedural and project knowledge through the use of a common repository,
- Developing a method for decomposing the integrated knowledge model into knowledge objects in accordance with the principles of teaching and cognitive science,
- Developing a method for learning process personalization in accordance with student's individual preferences by selecting the appropriate method of knowledge representation for didactic material and the choosing between deductive and inductive method of learning.

Ontological knowledge model. Repository stored domain knowledge in computer readable form is based on the selected knowledge model. Knowledge models are designed to reflect the complex nature of knowledge simultaneously with sufficient level of formalisms for computer processing. The computational aspect of knowledge models representation is important due to repository mechanisms. In proposed approach we decided to use ontological knowledge model. The description of the ontology content and structure can be found in [45]. We can apply analysed types of knowledge to base types of ontology models [18]:

- Theoretical knowledge can be reflected based on the domain and top-level/upper-level ontology. Theoretical knowledge covers the concepts definitions and relations, which can belong to a specific domain or be related to general concepts.
- Project knowledge is a result of project performance or development. Project knowledge is located in the method, application and task kind of ontology.
- Procedural knowledge provides tools for problem solving and can be found in the method, application and task ontology as well.

Ontology definition:

$G^D = \{W^D, L^D\}$ – domain ontology graph (oriented) [42], where $W^D = \{w^\nu\}$ are nodes of graph (concepts). The $\nu = 1, 2, 3$ is a knowledge type index and can takes values form set $\{fundamental\ knowledge, procedural\ knowledge, project\ knowledge\}$, $L^D = \{l\}$ is a ordered pairs of vertices, arcs of graph (relations between concepts). Every ontology concept is related to one type of knowledge (i.e. fundamental, procedural or project respectively). Knowledge of the specific type is expressed by an appropriate choice of computer's metaphor. The range of knowledge covered by the concept is defined by the operation aggregation (PART_OF), generalization (IS_A) and specialization (KIND_OF) and can be represented by the concept's matrix description structure [46]. Moreover, during the ontological graph constructing following rules must be follow:

1. The concepts related to the fundamental knowledge must be connected only with concepts related to the procedural knowledge.
2. The concepts related to the procedural knowledge must be connected only with concepts related to the project knowledge.

The example of domain ontology graph G^D for the Queuing Theory can be found in [42]. In addition, the paper covers problem of formalization of the this knowledge model for a given domain, the operations on ontology graph and the algorithm of the knowledge model creation.

$G^C = \{W^C, L^C\}$ – course ontology graph, where $W^C = \{w^c\}$ – nodes of graph (concepts), $L^C = \{l^c\}$ – ordered pairs of vertices, arcs of graph (relations between concepts), and $W^C \subset W^D, L^C \subset L^D$

$A_j = \{w^j\}$, $j = 1, 2, \dots, j^*$ – objectives (aims) of learning-teaching process for student i , where $\{w^j\}$ is a set of concepts, which has to be learned by the student.

$A^C = \bigcup_j A_j$ – learning-teaching objectives for group of student related to the curse C .

$G^C = \wp(G^D, A^C)$ course ontology graph is a projections of learning-teaching objectives on domain ontology graph. Such activity is a important element of personalisation process. The knowledge repository works proper (its personalised for every student) when we maximise the learning-teaching objectives representation in domain for each student:

$$G^C = G^D \cap A^C = \text{Max} \quad (4)$$

From the practical point of view the learning-teaching objectives is a set of related concepts from domain ontology G^D . Taking under consideration the limitations of the computer environment, educational information system characteristics and the structure of the domain ontology G^D the one has to build course ontologies G^C that supports (covers) specific learning objectives in best way. Since, each learning-teaching objectives is individual, the selection process is linked with the personalization process. Naturally, the personalization process can be improved with student's cognitive characteristics analysis.

Repository structure. The repository is a place intended for storage of records and materials preserving the ability to use them. The existing repositories can be used for the purpose of learning process as a source of domain outlook, research means of development or as a source of didactic materials [8]. By using the repository, elements of domain knowledge are shared among students, mainly in the form of Learning Objects and are interpreted as modules of knowledge that arise as a result of the analysis and division of knowledge into “objects” [47]. According to IEEE learning Object is any entity, digital or non-digital, that may be used for learning, education or training. The main knowledge repository mechanism is to provide Learning Objects to the students [8].

With the intention of making an order between different types of knowledge in course ontology G^C and provide the proper sequencing of Learning Object to the student we use the Knowledge Space Theory [48] According to Ley, Kump, and Albert [49] one of the central ideas of the Knowledge Space Theory is that solution dependencies exist among tasks of a domain. These solution dependencies are formally denoted by a prerequisite relation $\prec \subseteq A \times A$ that is interpreted as follows: when $a \prec b$ holds for two tasks $a, b \in A$, one can say that a is a prerequisite for b In our case the fundamental knowledge is prerequisite for procedural knowledge, which is prerequisite for project knowledge.

The Knowledge Space Theory defines a knowledge structure as a pair (Q, Ψ) in which $Q \neq \emptyset$, $\Psi \subseteq 2^Q$ [50] The set Q is called the domain of the knowledge structure and its elements are called items. We also say that Ψ is a knowledge structure on a set Q . The elements of Ψ are called knowledge states. A knowledge structure (Q, Ψ) is called a knowledge space if Ψ is closed under union. A knowledge space (Q, Ψ) is called quasi-ordinal if Ψ is closed under intersection and is denote (Q, \leq) . As a result the relation \leq on a set Q which is reflexive and transitive is a partially order relation [51].

Let introduce the competence portion $P_k = \{w_k^c, \leq\}$, which consists partially order set of concepts from course’s concept set $W^C = \bigcup_k P_k$. Pursuing the learning-teaching objectives we aim to maximize portions cover ratio of the knowledge and maintain relationships in the domain:

$$W^C = \bigcup_k P_k = \max. \quad (5)$$

The competence portion may contain different amounts of concepts and different knowledge types. In the ODL condition the competence portion is send to the students as a computer-based structure of Learning Object [42]

Discussion of the solution method. All models in this section based on the ontology approach. There are many ways to create ontologies [45]. Each of them identified concept comprising the ontology. The classic one [52] starts with classes definition, including properties and classes constrains definition. With the purpose of reflection real situation the ontology model is supplemented with instances creation process. The ontology model used in the article extend this approach and proposed matrix structure to describe the concept’s nature in

details [46]. Because proposed method used class oriented approach, the created ontology can be expressed in OWL Web Ontology Language and be edited in Protégé editor [45].

After the ontology creation the problem of ontology processing according to formulas (4) and (5) appears. We leave on the side the optimization problem that can be solved by known methods and focus on the goal of these formulas. The formulas (4) and (5) are related to ontology personalisation problem: how to adapt/reduce the ontology according to set of concept? The solutions of such problem can be found in ontology matching literature [53] However the authors propose didactic materials compilation algorithm from [42] due to its hierarchical nature, which supported partial order of competence portion.

Relation with the Behavioral model. One of the most important element of the knowledge representation model is the competence portion. On the one hand the competence portion is passed to the Learning Management System (LMS) as part of personalized learning-teaching process. The LMS sent the competence portion to the student in the form of the Learning Object [42] in accordance with the e-learning standard SCORM (Shareable Content Object Reference Model) [54]. As the result the proposed knowledge representation model is a base for all system communication related to learning-teaching process (including personalisation).

On the other hand, the competence portions and concepts inside them are the base for the creation of tasks in the behavioral model. These tasks are of varying complexity. In addition, the knowledge representation model affects the performance of behavioral model by providing:

- Order of tasks: course ontology concepts are main component of tasks. The relations between concepts affected the relation (order) between tasks.
- Type of knowledge associated with the concept: all ontology concepts are characterise by the type of knowledge from set $\{v\} = 1, 2, 3$.
- The range of the knowledge contained in the course ontology graph: the course ontology graph contains all the things that student have to learn according to his/her learning objectives.

5.3. Behavioral model. In the process of learning-teaching the student is participating in the development of the didactical materials. In addition, during the competence transfer process, some strongly motivated students can participate in the repository upgrade process. Therefore, the model of cooperation between the teacher and the student can be considered as a model of motivation, where the teacher affects student motivation through the organization of the learning-teaching process. The proposed model is based on [20].

A structure of the model:

- The student’s competence acquisition process as a chain of intelligent operations for the performing tasks with certain conditions for completion,

- The process of supporting the students' work by the teacher through collaboration and tasks assessment,
- The process of changing the degree of repository completeness, depending on the effectiveness of student's performance with the respect to the tasks.

Goal of the model:

- Modelling mutual influence of the described processes on the growth of knowledge in the repository within a defined time frame, depending on: (a) the teacher's choice of strategy based on his/her research and teaching interests and time constraints, (b) the degree of ambition and proficiency level of each student, reflected in the selection and execution of tasks, and his/her time constraints.
- The criterion is the following: the rate of filling in of the repository and the maximum growth of knowledge during the learning-teaching process of each student individually and all students together.

Set of tasks:

- Developing the student's award function on the set of tasks that ensure the fastest repository growth within the specified time interval.
- Developing the student's preference function on the set of tasks through the choice of acceptable meanings of the effectiveness of task's solution.
- Calculation of the performance efficiency parameters of the repository filling-in process management system.

Teacher's motivation function. The teacher is responsible for the course. The required course's knowledge is covered by the course ontology. The teacher designs knowledge objects (fundamental, procedural and project oriented) for students in order to build up their competencies. There is a minimum level of knowledge which translates into a minimum, sufficient level of competence. Student based on their motivation may increase the level of competence by attempting more difficult tasks. Teacher affects two parameters of tasks that are delivered to the student: complexity level and task's topicality. Teacher plans a strategy to upgrade selected areas of the course ontology. Let us define teacher's motivation function σ^N , which is a monotonously rising function of a discrete argument $q(r_i)$, $i = 1, 2, \dots, i^*$:

$$\sigma^N = \sigma(q(r_i), u(r_i)), \quad (6)$$

where $q(r_i)$ – task r_i complexity level, $u(r_i)$ – task's topicality for the teacher.

The teacher's motivation function is a function which depend on tasks parameters, the tasks can be described by vector $\bar{X}(r_i)$ and mainly covered following items: didactic materials, consultation time, time of access to telecommunication channels, equipment and software, etc. The form of satisfying the teacher's interests is placing in the repository a properly solved task of a significantly high level of complexity.

Student's motivation function. The form of satisfying the student's interests is minimal summary time costs while obtaining a high grade, which also depends on the complexity

level of the task. The student's preference function is following:

$$\sigma_j^S = \sigma_j^S(q(r_i), z(r_i)), \quad (7)$$

where $q(r_i)$ – complexity level of task r_i , $z(r_i)$ – attractiveness of task r_i for the student s_j .

In seek of clarity we assume two levels of tasks difficulty: simple (A) and complex (B). From the point of view of learning objectives the whole group of students can be divided generally into two extreme groups. For the first group of students (interesting in achieving the minimal acceptable success level by solving simple task) the motivation function σ_j^S is a monotonously falling function of a discrete argument $q(r_i)$. For the second group of students (interesting in filling the repository with the maximal possible success level and dealing with complex task) the motivation function σ_j^S is monotonously rising function of $q(r_i)$.

Under effectiveness of the decision made by the student we understand maximal satisfaction of student's and teacher's interests with maximal summary motivation function. The fact of student's decision making the decision can be described by a binary argument, y_i^j

$$y_i^j = \begin{cases} 1, & \text{if student } s_j \text{ chooses task } r_i \\ 0, & \text{otherwise} \end{cases}.$$

Then, the motivation function of the student has the following structure:

$$\Phi(y_i^j) = \alpha \sigma^N + \sigma_j^S = \text{Max}_Y, \quad (8)$$

where

$$Y = \{y_i^j\}, \\ i = 1, 2, \dots, i^*, \quad j = 1, 2, \dots, j^*$$

and α is waging coefficient.

Both elements of the student's motivation function depend on the same argument. The element σ^N is a monotonous rising function of argument $q(r_i)$, while σ_j^S in dependence on kind of student is monotonously falling or rising function of $q(r_i)$. The visual representation of functions σ^N , σ_j^S , $\Phi(y_i^j)$ can be found in [20].

Goal function of motivation model – function of repository knowledge increasing. The period of filling the repository is limited by a calendar interval $[0, T_0]$ depending on the educational situation. The current state of knowledge in the repository is characterized based on the comparison of course ontology graph G^C with graph of properly solved tasks G^P . The student chooses tasks according to his/her goal function: $\tilde{R} = \{r_i^s s_j\}$, $r_i \in R$, $s_j \in S$. The result of each solved task $r_i^s s_j$ can be represented as a ontology graph made by student S_j : $G(r_i^s s_j) = \{W_i^s L_i^s\}$. Each solved complex task can increase the knowledge ΔW in the domain ontology G^D placed in repository, meaning $\Delta W(r_i^s) = G^D \cap G(r_i^s)$. The $\nu = 1, 2, 3$ is a knowledge type index and can takes values form set $\{\text{fundamental knowledge, procedural knowledge, project knowledge}\}$.

By the symbol G^P we represent summary graph of ontologies of tasks placed in the repository in the interval $\tau \subset [0, T_0]$ and formulated in following way:

$$G^P = G(r_1^V(s_1)) \cup G(r_2^V(s_2)) \cup \dots \cup G(r_i^V(s_j)) \cup \dots$$

$$= \bigcup_{j=1}^{j^*} G(r_i^V(s_j)). \quad (9)$$

The relation between ontologies is following $G(r_i) \subseteq G^P \subseteq G^C \subseteq G^D$.

The accrual of knowledge in the repository in the interval $\tau \subset [0, T_0]$ is represented by number of concept which repository ontology G^P has in common with domain ontology G^D :

$$U(T_0) = |G^D \cap G^P|, \quad (10)$$

where $|G^D \cap G^P|$ means a number of vertices/concepts of joint graph.

The development effort should be invested to maximise the knowledge actuality in the repository in the certain calendar interval $[0, T_0]$:

$$U(T_0) = |G^D \cap G^P| = \text{Max}. \quad (11)$$

However, such formula is difficult to calculate, due to difficulty with ontology processing, and should be transformed to more practical one. One of the proposition is to maximise the number of solved complex tasks in the repository selected by group of students $S = \{s_j\}$ in a certain calendar interval $[0, T_0]$:

$$|\{r_i^V(s_j)\}| = \text{Max}, \quad i = 1, 2, \dots, i^*, \quad j = 1, 2, \dots, j^*, \quad (12)$$

where $|\{r_i^V(s_j)\}|$ is degree of a set.

Constrains:

1. the knowledge accrual in the repository has to above level U^μ

$$U(T_0) = |G^D \cap G^P| \geq U^\mu, \quad (13)$$

where U^μ is a minimal number of concept which repository ontology G^P has in common with domain ontology G^D .

2. the complexity level of task r_i , has to be above level Q^μ :

$$\forall_i q(r_i^V) \geq Q^\mu, \quad (14)$$

where $Q^\mu = \langle 0, 1 \rangle$ represented minimal complexity level for all repository content. The function $q(r_i^V)$ is calculated by the teacher, who discretely estimate each task r_i^V complexity. Moreover, through the formula (14) the specific type of knowledge (following the knowledge type index v) can be treated specially.

Interpretation and solution of the Behavioral model. The behavioral model is described in descriptive way in order to the sake of clarity of relationship between learning-teaching process participants. Based on the [20] we can formulate model in the terms of games theory, which allows studying the activity of a system depending on the players behaviour. The

cooperation in behavioral model can be interpreted as a cooperative game of j^* independent participants/students of game with a defined number of steps and full information about participants activities in real-time. The game has following description in [20]:

- the *win* of the teacher is accrual of knowledge in the repository,
- the *win* of the student depends on his/her strategy: maximal number of points for a task solved or minimal time loss,
- the equilibrium is obtained as a result of a dominant strategy, what compared to other strategies gives the game participants the possibility to obtain their maximal *win* regardless of actions of the other participants.

There is co-operation between teacher and each student s_j .

Moreover the motivation model can be seen as a stimulation task, where motivation management signifies direct rewarding an agent (student) for his actions. Management (stimulation) effectiveness means obtaining maximum value of the goal function on an appropriate set of game solutions (strategy of agents having balance in their stimulation). The problem can be solved based on algorithms [55] and [56].

Separate issue is the way to identify the introduced parameters and functions. Some proposition are described in [57]. For example the student motivation is a component of: self's ability to assimilate the subject, teacher assessment requirements, quality of the supplied learning material, interest in the subject topics, amount of material in the course (e.g. the number of hours per subject, the number of documents to study). All this characteristics are combined based on the multicriteria decision-making characteristic objects method [58], which used fuzzy logic to produce final level of student's motivation. For other parameters and functions similar approach can be applied.

Relation with the Servicing model. In the servicing model, we don't analyse the content of knowledge increasing process. The main model objectives is to calculate, based on the data from the behavioural model, the parameters of servicing process, for example:

- average time of complex tasks processing in the system,
- average time of simple tasks processing in the system,
- total waiting time and operating time including the time of consultation,
- total time the teacher lost on consultation.

If those times validate the permissible restriction, one have to return to the behavioural model in order to change the function of teacher motivation. For servicing model the most important characteristics of behavioural model are the number of simple and complex tasks and complexity level of each task.

5.4. Servicing model. There are many indications showing that the ODL process should be treated as stochastic one:

- The system is open, due to ODL characteristics.

- Student’s service time does not depend on the other student service time.
- Student’s service is stochastic.

The student’s action (e.g. the repository usage, consulting with teacher, working with a dedicated server) will be treated as an event occurring in the planning horizon. The specificity of the learning-teaching process allows to specify a time unit, within the horizon of time, for which it is possible to determine the average number of events (from the experience of the teacher). Such an interpretation allows the planning process based on the modelling of the events. Student’s action (event) in the repository is associated with performing the operation on ontology graph. The stream of events was interpreted as a markovian stochastic process, i.e. stationary, sequential and memoryless (on time interval $[0, T_0]$).

The stationarity assumption comes from teacher’s experience of preliminary assessment of the students, the existing rules of the learning-teaching process and the need to respect the didactical principles of teaching.

Every computer system is running on limited resources. In the case of the learning-teaching process the limited resource are on the side of the teacher (i.e. the time that teachers can spend per student for consultation or to check the task quality) [59]. We assume that the effect of supporting computer systems is instantaneous. The purpose of building the servicing model is to minimize the summary of expenses involved in the learning-teaching process at the operational level. The model is based on the intangible production network for competence development in Open and Distance Learning [19].

Structure of the model:

- A set and sequence of intelligence operations that consist for the entire process of competence acquisition by the student within a particular specialization.
- Characteristics of the arrival pattern/beginning of performance of each operation by the student: rate of arrival, etc.

Goal of the model:

- Finding the structure and parameters of the open distance learning network, which maximizes the effectiveness of the student’s competence acquisition process.

Set of tasks:

- Definition of the open production network performance parameters such as: the average number of students who are in the process of learning; the average number of students who have successfully completed the learning process; the average time spent by a student in the network, the average waiting time for access to the teaching resources; the speed of filling in the repository of knowledge in the learning process.

Education process participants. The learning-teaching process is coordinated by the teacher (T), who is responsible for leads of the subject, disposer of the subject repository. The students $S = (s_1, s_2, \dots, s_j, \dots)$ are coming to

the system, choose task and try to solve it. The $\tilde{\tau}(s) = (\tau_1(s_1), \tau_2(s_2), \dots, \tau_j(s_j), \dots)$ is a stochastic process of students arrival, $\tilde{\tau}(s) = \{\chi, \lambda\}$ – parameters of stochastic process of students arrival, where χ is a kind of arrival pattern, e.g. Poisson flow, λ is rate/intensity of arrival. Earlier in the paper, we assume that only two kind of task will be analyzed (A – simple, B – complex). We can formalize the students input flow in the following way:

$$\lambda = \lambda^A + \lambda^B, \tag{15}$$

where λ^A – rate of the input flow of student who selected a simple task. λ^B – rate of the input flow of student who selected complex (hard) task. We accept the process $\pi(s)$ to be a Markovian one, meaning that it has a stationary, memoryless and sequential character with finite population on limited time interval.

Processing structures. The analysed processing structure is the same for theoretical, procedural and project knowledge. The M/M/1 system approach to individual stage of competence-based learning-teaching process modelling is a simplification for clarity of the model [60]. The students’ arrival and servicing time are a stochastic process and can be interpreted as a Markovian one due to large number of students, students mutual independence, similar basic knowledge, and similar servicing time. The teacher can establish priorities (static or dynamic) in the students’ servicing process. Let’s define processing structure for simple and complex task.

The simple task’s stage structure is presented in Fig. 6. The student can finish this stage in the following ways: p_1^A – probability of finish the task with a positive result of assessment, p_2^A – probability of return to decision block, p_3^A – probability of exit from the production system.

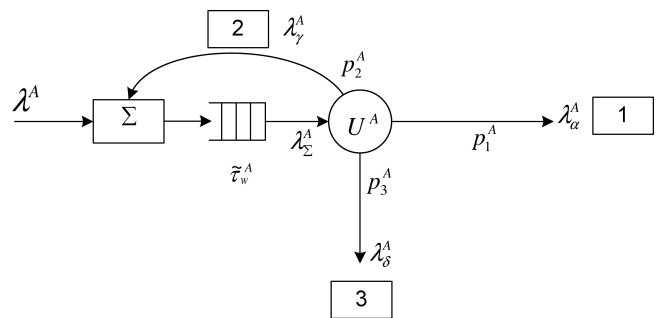

Fig. 6. Simple task’s processing structure (adapted from Ref. 19)

Traffic equations for the simple task’s stage:

$$\begin{cases} \lambda_\alpha^A = \lambda_\Sigma^A p_1^A, \\ \lambda_\gamma^A = \lambda_\Sigma^A p_2^A, \\ \lambda_\delta^A = \lambda_\Sigma^A p_3^A. \end{cases} \tag{16}$$

The complex task’s stage structure (Fig. 7) has the following description: p_1^B – probability of finishing the task with a positive result of assessment (the task is too simple to put it into the repository), p_2^B – probability of returning to the

selection block (new task selection), p_3^B – probability of escaping from the system, p_4^B – probability of finishing the task with a positive result assessment and having the task recorded in the knowledge repository (R), $p_1^B + p_2^B + p_3^B + p_4^B = 1$ – normalization condition, $\lambda_\Sigma^B = \lambda^B + \lambda_\Sigma^B p_3^B$ – input rate.

Traffic equations for the creative task stage:

$$\begin{cases} \lambda_\alpha^B = \lambda_\Sigma^B p_1^B, \\ \lambda_\beta^B = \lambda_\Sigma^B p_4^B, \\ \lambda_\delta^B = \lambda_\Sigma^B p_2^B, \\ \lambda_\gamma^B = \lambda_\Sigma^B p_3^B. \end{cases} \quad (17)$$

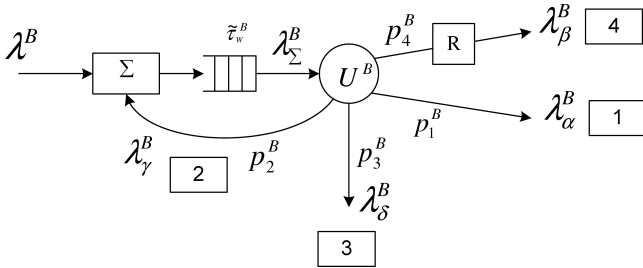

Fig. 7. Complex task's processing structure (adapted from Ref. 19)

Knowledge in the repository is increasing over time due to complex (creative) tasks analysis. In the best cases, the student is able to finish hard task in the manner that the task's solution can be transferred to the repository.

The model of individual stage of competence-based learning-teaching process can be found in Fig. 8. The student's activity is limited by the period time and teacher's working hours.

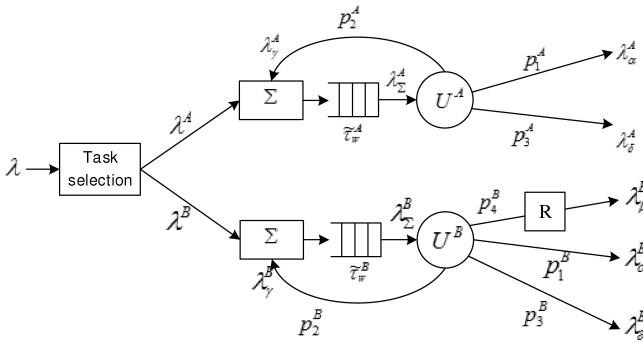

Fig. 8. Generalization of the stage structure

Servicing parameters of learning-teaching system. For the M/M/1 system the average time of the simple and the hard task's servicing is the following:

$$\tilde{\tau}^A = \frac{1}{\mu_A}, \quad (18)$$

$$\tilde{\tau}^B = \frac{1}{\mu_B}. \quad (19)$$

Let's define the parameters of the task selection and execution (servicing) process for the structure in Fig. 8: $\tilde{\tau}^A$ – average

time of simple task execution, $\tilde{\tau}^B$ – average time of hard task execution, $\tilde{\tau}_W^A, \tilde{\tau}_W^B$ – average waiting time of hard and simple task respectively, $\tilde{T}_S^A = \tilde{\tau}^A + \tilde{\tau}_W^A$ – average time during which the simple task (A) stays in the system, $\tilde{T}_S^B = \tilde{\tau}^B + \tilde{\tau}_W^B$ – average time during which the hard task (B) stays in the system, $N^A = \lambda_\Sigma^A \tilde{T}_S^A$ – average number of simple tasks (A) in the system, $N^B = \lambda_\Sigma^B \tilde{T}_S^B$ – average number of hard tasks (B) in the system, $\lambda = \lambda^A + \lambda^B$ – input flow decomposition.

Based on the Little's law for M/M/1 system characteristic [60], the following parameters can be formulated for the discussed system of the hard and simple task transferring.

Average number of tasks in the system:

$$N = N^A + N^B, \quad (20)$$

where

$$N^A = \frac{\lambda_\Sigma^A}{\mu_A - \lambda_\Sigma^A} = \frac{\lambda_\Sigma^A \tilde{\tau}_O^A}{1 - \lambda_\Sigma^A \tilde{\tau}_O^A}, \quad (21)$$

$$N^B = \frac{\lambda_\Sigma^B}{\mu_B - \lambda_\Sigma^B} = \frac{\lambda_\Sigma^B \tilde{\tau}_O^B}{1 - \lambda_\Sigma^B \tilde{\tau}_O^B}. \quad (22)$$

Average time during which a task stays in the system:

$$\tilde{T}_S^A = \frac{N^A}{\lambda_\Sigma^A} = \frac{1}{\mu_A - \lambda_\Sigma^A} = \frac{\tilde{\tau}_O^A}{1 - \lambda_\Sigma^A \tilde{\tau}_O^A}, \quad (23)$$

$$\tilde{T}_S^B = \frac{N^B}{\lambda_\Sigma^B} = \frac{1}{\mu_B - \lambda_\Sigma^B} = \frac{\tilde{\tau}_O^B}{1 - \lambda_\Sigma^B \tilde{\tau}_O^B}. \quad (24)$$

Average waiting time for a task to be executed:

$$\tilde{\tau}_W^A = \tilde{T}_S^A - \tilde{\tau}_O^A, \quad \tilde{\tau}_W^B = \tilde{T}_S^B - \tilde{\tau}_O^B. \quad (25)$$

Average number of tasks in the waiting queue:

$$N_W^A = \lambda_\Sigma^A \tilde{\tau}_W^A, \quad N_W^B = \lambda_\Sigma^B \tilde{\tau}_W^B. \quad (26)$$

Discussion of simulation model processing. The discussed simulation model taking into account several parameters (e.g. students and teachers motivation, tasks complexity) in order to estimate the organization characteristics and predict the growth of knowledge in the repository during competence transfer. The learning-teaching process is treated as a stochastic process, and can be modelled using the simulation tools based on the Queuing Systems Theory (like Arena Simulation Software by Rockwell Automation).

Some initial models can be found in [13]. In this simulation experiment the single knowledge transfer was simulated. For example the analysed shown that for 55 students, time interval of 6 days, daily time for tasks' examination – 3 hours, expected time for each student – 20 minutes, correction time – 1 day: 70% – exit with promotion without repository development, 15% – placing solution in the repository, 15% – sending back for correction. Moreover, the teacher's queue was still not unloaded. As a result the time interval has to be extended to 8 days in order to all the students left the learning-teaching process with new knowledge.

6. Conclusions

In discussed models we assume that in order to acquire specific competence one have to acquire fundamental, procedural and project knowledge that combine to create the competence. The proposed approach is designed in a way that it is possible to extend on to other types of knowledge. Moreover, it is possible to introduce some more sophisticated personalization algorithms in the future. The article shows only one course with related ontology in learning-teaching process. All elements create an education system, which based on superposition can be transferred to a different educational situations.

The increasing mobility of students, caused by Bologna Process implementation, allows student to choose university several times, at different stages of education. Combined with demographic factors and the dynamic characteristic of new competence emergence the stochastic factor is increasing, which in turn increases the difficulty of long-term planning of the internal system of education.

REFERENCES

- [1] G. Hessami and M. Moore, "Manage competence not knowledge", in *Integrated Systems, Design and Technology*, pp. 227–242, Berlin Heidelberg: Springer-Verlag, 2011.
- [2] J. Sandberg, "Understanding of work: the basis for competence development", in *Int. Perspectives on Competence in the Workplace* ed. C.R. Velde, pp. 57–85, Springer, Berlin, 2009.
- [3] R. Sanchez, "Understanding competence-based management: Identifying and managing five modes of competence", *J. Business Research* 57 (5), 518–532 (2004).
- [4] X. Boucher, E. Bonjour, and N. Matta, "Competence management in industrial processes. Editorial", *Computers in Industry* 58 (1), 95–97 (2007).
- [5] B. Chakroun, "National qualification frameworks: from policy borrowing to policy learning", *Eur. J. Education* 45 (2), 199–216 (2010).
- [6] P. Różewski, B. Małachowski, and P. Dańczura, "Concept of competence management system for Polish National Qualification Framework in the Computer Science area", *Proc. Federated Conf. on Computer Science and Information Systems. FedCSIS 2013*, 777–783 (2013).
- [7] M.S.G. Harris, "Fulfilling a European vision through flexible learning and choice", *Eur. J. Education* 47, 424–434 (2012).
- [8] P. Różewski, E. Kusztnina, T. Tadeusiewicz, and O. Zaikin, "Intelligent open learning systems: concepts, models and algorithms", *Intelligent Systems Reference Library* 22, CD-ROM (2011).
- [9] R. Tadeusiewicz, "Selected problems resulting from the use of internet for teaching purposes", *Bull. Pol. Ac.: Tech.* 56 (4), 403–409 (2008).
- [10] K. Umbleja, V. Kukk, and M. Jaanus, "Competence-based approach to learning", *Global Engineering Education Conf. (EDUCON)* 1, 552–559 (2013).
- [11] M. Hertlein and S. Smolnik, "How can knowledge management support competence-based learning? Towards a research agenda", *45th Hawaii Int. Conf. on System Sciences* 1, 3661–3668 (2012).
- [12] A.V. Sánchez and M.P. Ruiz, *Competence-based learning. A Proposal for the Assessment of Generic Competences*, Universidad de Deusto, Deusto, 2008.
- [13] P. Różewski and M. Ciszczyk, "Model of a collaboration environment for knowledge management in competence-based learning", *1st Int. Conf. on Computational Collective Intelligence. Semantic Web, Social Networks and Multiagent Systems (ICCCI)* 9, 333–344 (2009).
- [14] K. Enaleev, "Optimal incentive-compatible mechanisms in active systems", *Automation and Remote Control* 74 (3), 491–505 (2013).
- [15] D.A. Novikov and T.E. Shokhina, "Incentive mechanisms in dynamic active systems", *Automation and Remote Control* 64 (12), 1912–1921 (2003).
- [16] D.A. Novikov, "Incentives in teams under fuzzy uncertainty", *12-th Int. Conf. on Systems Engineering* 2, 171–175 (1997).
- [17] J. Klamka, "Controllability of dynamical systems. A survey", *Bull. Pol. Ac.: Tech.* 61 (1), 335–342 (2013).
- [18] P. Różewski, "Model of intangible production network for competence development", *5th Int. Conf. on Knowledge Science, Engineering and Management (KSEM)* 2011, 246–256 (2011).
- [19] P. Różewski, "Concept of intangible production network system for competence development in open and distance learning", *Management and Production Engineering Review* 2 (3), 52–62 (2011).
- [20] E. Kusztnina, O. Zaikin, and R. Tadeusiewicz, "The research behavior/attitude support model in open learning systems", *Bull. Pol. Ac.: Tech.* 58 (4), 705–711 (2010).
- [21] The European Qualification Framework website, <http://ec.europa.eu/eqf>, (access: 27.09.2013).
- [22] Knowledge on Demand – project website, <http://kod.iti.gr>, (access: 27.09.2013).
- [23] TenCompetence: Building the European network for lifelong competence development – project website, <http://www.tencompetence.org>, (access: 27.09.2013).
- [24] TENCompetence Project, *Frequently Asked Questions*, <http://tencompetence-project.bolton.ac.uk/node/123/index.html>, (access: 27.09.2013).
- [25] QUALITY: Quality Implementation in open and distance learning in a multicultural European environment – project website, <http://www.uta.fi/projects/e-quality>, (access: 27.09.2013).
- [26] ADAM Leonardo da Vinci portal, thematic group EQF, <http://www.adam-europe.eu/adam/>, (access: 27.09.2013).
- [27] ICOPER: Interoperable Content for Performance in Competency-driven Society – project website, <http://icoper.org>, (access: 27.09.2013).
- [28] eCOTOOL: eCOMpetences TOOLS – project website, <http://www.competencetools.eu/>, (access: 27.09.2013).
- [29] V. Tarasov, "Ontology-based approach to competence profile management", *J. Universal Computer Science* 18 (20), 2893–2919 (2012).
- [30] S. Colucci, E. Tinelli, E. Di Sciascio, and F.M. Donini, "Automating competence management through non-standard reasoning", *Engineering Applications of Artificial Intelligence* 24 (8), 1368–1384 (2011).
- [31] F. Draganidis, P. Chamopoulou, and G. Mentzas, "A semantic web architecture for integrating competence management and learning paths", *J. Knowledge Management* 12 (6), 121–136 (2008).
- [32] M. Howard, "Mathematical learning theory through time", *J. Mathematical Psychology* 59, 18–29 (2014).
- [33] J. Keller, *Motivational Design for Learning and Performance: The ARCS Model Approach*, Springer, Berlin, 2010.

- [34] E. Novak, "Toward a mathematical model of motivation, volition, and performance", *Computers & Education* 74, 73–80 (2014).
- [35] Y. Wang, "The theoretical framework and cognitive process of learning", *6th IEEE Int. Conf. on Cognitive Informatics* 1, 470–479 (2007).
- [36] Y. Wang and Y. Wang, "Cognitive informatics models of the brain", *IEEE Trans. on Systems, Man, and Cybernetics* 36 (2), 203–207 (2006).
- [37] S. Grant and R. Young, "Concepts and standardization in areas relating to competence", *Int. J. IT Standards and Standardization Research* 8 (2), 29–44 (2010).
- [38] F. Draganidis and G. Mentzas, "Competency based management: a review of systems and approaches", *Information Management & Computer Security* 14 (1), 51–64 (2006).
- [39] V. Chiesa and R. Manzini, "Competence levels within firms: a static and dynamic analysis", in *Competence-based Strategic Management*, pp. 195–214, ed. A. Heene, R. Sanchez, Wiley, London, 1997.
- [40] HR-XML Consortium web site, <http://www.hr-xml.org/>, (access: 27.09.2013).
- [41] P. Różewski and B. Małachowski, "System for creative distance learning environment development based on competence management", *14th Int. Conf. on Knowledge-based and Intelligent Information and Engineering Systems (KES)* 2010, 180–189 (2010).
- [42] O. Zaikin, E. Kushtina, and P. Różewski, "Model and algorithm of the conceptual scheme formation for knowledge domain in distance learning", *Eur. J. Operational Research* 175 (3), 1379–1399 (2006).
- [43] A. Poniszewska-Marañda, "Modeling and design of role engineering in development of access control for dynamic information systems", *Bull. Pol. Ac.: Tech.* 61 (3), 569–579 (2013).
- [44] V. Kulba, S. Nikolsky, and O. Zaikin, "Ontological approach to modelling of discrete event dynamic system", *Bull. Pol. Ac.: Tech.* 57 (3), 241–247 (2009).
- [45] A. Gomez-Perez, M. Fernandez-Lopez, and O. Corcho, *Ontological Engineering: with Examples from the Areas of Knowledge Management, e-Commerce and the Semantic Web*, Springer, Berlin, 2004.
- [46] E. Kushtina, P. Różewski, and O. Zaikin, "Extended ontological model for distance learning purpose", *6th Int. Conf. on Practical Aspects of Knowledge Management (PAKM)* 2006, 155–165 (2006).
- [47] R. McGreal, "A typology of learning object repositories", in *Handbook on Information Technologies for Education and Training*, pp. 5–28, ed. H.H. Adelsberger Kinshuk, J.M. Pawlowski, and D. Sampson, Springer, Berlin, 2008.
- [48] J.-P. Doignon and J.-C. Falmagne, *Learning Spaces*, Springer, Berlin, 2011.
- [49] T. Ley, B. Kump, and D. Albert, "A methodology for eliciting, modelling, and evaluating expert knowledge for an adaptive work-integrated learning system", *Int. J. Human-Computer Studies* 68 (4), 185–208 (2010).
- [50] S. Brandt, D. Albert, and C. Hockemeyer, "Surmise relations between tests – mathematical considerations", *Discrete Applied Mathematics* 127 (2), 221–239 (2003).
- [51] H. Lihong, Q. Xiansheng, and H. Yanjun, "A capability assignment concept model for resource management system of product development", *IEEE Int. Symp. on Industrial Electronics (ISIE)* 2007, 1927–1932 (2007).
- [52] N. Noy and D. McGuinness, "Ontology development 101: a guide to creating your first ontology", *Stanford Knowledge Systems Laboratory Technical Report KSL-01-05*, CD-ROM (2001).
- [53] P. Shvaiko and J. Euzenat, "Ontology matching: state of the art and future challenges", *IEEE Trans. on Knowledge and Data Engineering* 25 (1), 158–176 (2013).
- [54] V. Gonzalez-Barbone and L. Anido-Rifon, "Creating the first SCORM object", *Computers & Education* 51 (4), 1634–1647 (2008).
- [55] M. Shubik, "Game theory in the social sciences: concepts and solutions", MIT Press, Massachusetts, 1991.
- [56] D.A. Novikov, *A Theory of Control in Organizations*, Sinteg, Moscow, 2012.
- [57] M. Malinowska, "The reference model of information system for competence development monitoring", *Ph.D. Thesis*, West Pomeranian University of Technology, Szczecin, (2013), (in Polish).
- [58] W. Sałabun, "The characteristic objects method: a new distance-based approach to multicriteria decision-making problems", *J. Multi-Crit. Decis. Anal.*, Doi: 10.1002/mcda.1525 (2014).
- [59] E. Kusztina, O. Zaikin, P. Różewski, and B. Małachowski, "Cost estimation algorithm and decision-making model for curriculum modification in educational organization", *Eur. J. Operational Research* 197 (2), 752–763 (2009).
- [60] O. Zaikin, *Queuing Modelling of Supply Chain in Intelligent Production*, Informa, Szczecin, 2002.