

# Quantitative analysis of reinforcing phase in AlSi11/CrFe30C8 composite castings

A. Dulęba\*, D. Scelina, M. Cholewa

Department of Foundry, Faculty of Mechanical Engineering, Silesian University of Technology,  
Towarowa 7, 44-100 Gliwice, Poland

\*Corresponding author. E-mail address: [anna.duleba@polsl.pl](mailto:anna.duleba@polsl.pl)

Received 25.07.2011; accepted in revised form 27.07.2011

## Abstract

In this paper assessment of the morphology and segregation of the reinforcing phase based on optical quantitative analysis was achieved. Microscopic observation of AlSi11/CrFe30C8 composite gravity castings was carried out in electromagnetic field. The purpose of investigation was the analysis of current frequency influence supplying the inductor of electromagnetic field on segregation, quantity and morphology of reinforcement phase in aluminum matrix composite. Technological conception of investigations was based on assumption that chromium-iron matrix of particles dissolved in aluminum composite matrix and carbide phases became actual reinforcement of the composite. Gravity segregation was analyzed. Graphs containing distribution of reinforcing phase in metal matrix were shown.

**Keywords:** Composite, Segregation, Electromagnetic field

## 1. Introduction

Presented research results and prospects for their development are a consequence of the analysis of the authors experiences [1-5] and available literature [6-8]. In order to confirm the results obtained in works [1-3] procedure, performed tests were repeated and extended for AlSi11 aluminum alloy.

Variable conditions faced by the elements used eg: in the automotive industry, aerospace and energetics resulted in demand for new material, stronger, harder, lighter and more resistant to higher temperatures. Commonly used materials are not able to meet current requirements. Aluminum composite through its beneficial technology and utility properties is increasingly being used as casting material construction replacing traditional engineering materials in almost every industry. But it is still at the stage of development [1-8].

Due to the increasing customer demand for this material, scientists are still looking for a new species of composites with increasingly higher properties: mainly tribological and functional.

## 2. Purpose and scope of research

The aim of the study was to determine the effect of changes in frequency of the current power inductor on gravitational segregation and morphology of the reinforcing phase in the matrix composites. Gravity segregation was analyzed.

Technological concept of investigations, as in work based on the assumption that chromium-iron of CrFe30C8 particles dissolved and residual carbide phases, will be substantial strengthening the composite.

Taking into account the phenomena affecting the distribution of reinforcing phase in the matrix composite and the results of their experimental control distribution of reinforcing phase in the matrix composite was searched. In order to do this research included the following steps:

- fabrication of CrFe30C8 particles;
- producing a composite suspension;
- execution of trial castings;

- quantitative analysis of reinforcing phase with used light microscope Nikon EPIPHOT – TME - computerized image analyser NIKON Nis Elements;
- determination the correlation between the structure refinement and distribution of reinforcing phase and frequency of supply current inductor.

### 3. Methodology of the research

To perform the test casts was used casting aluminum alloy AlSi11(table 1). Reinforcing phase was CrFe30C8 particles (table 2) about 100, 200 and 315  $\mu\text{m}$  granularity (fig. 1).

Table 1.

Chemical composition of AlSi11 used to investigation according to norm PN-EN 1706:2001

EN AC - AlSi11 (AK11)	
Chemical composition	Element content in [%]
Si	10,05
Cu	0,24
Mg	0,23
Mn	0,16
Ni	0,02
Fe	0,58
Zn	0,08
Ti+Zr	0,05
Inne	0,05

Table 2.

Chemical composition of CrFe30C8 particples

	Chemical composition, [%]					
	Cr	Fe	C	Si	P	S
CrFe30C8	61,07	30,16	7,88	0,85	0,02	0,02

a)

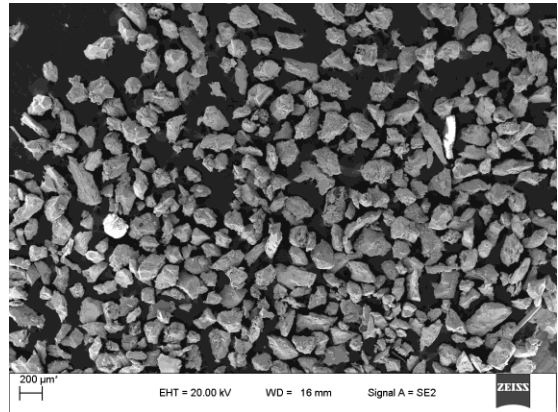

b)

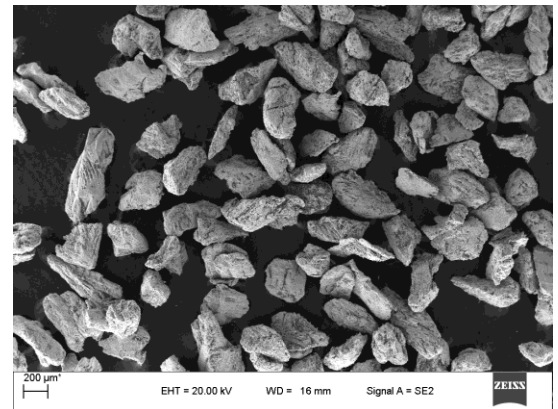

c)

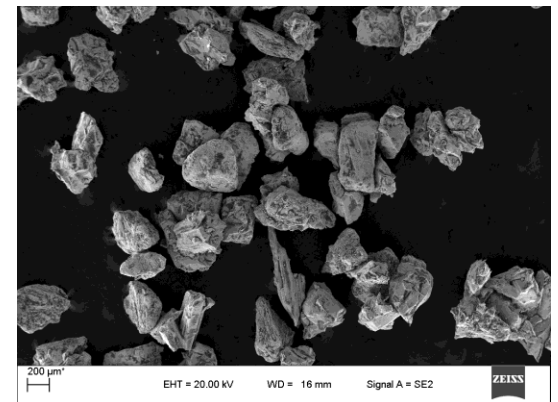

Fig. 1. Particles CrFe30C8 used in tests: a) 100 $\mu\text{m}$ , b) 200 $\mu\text{m}$ , c) 315 $\mu\text{m}$

CrFe30C8 particles (Fig. 1) used for testing were in the next step subjected to quantitative analysis aimed to determine their morphological module and permetical influencing the wettability.

In this research Hartley experiment plan was used. Three variable factors at three levels (+, 0, -) was accepted (table 3). Adopted variables factors were: particles size Z (100; 200; 315  $\mu\text{m}$ ), power inductor current  $I$  (5; 7,5; 10 A) and frequency inductor supply current  $f$  (50; 75; 100 Hz).

The basic plan of the experiment included the performance of 11 experiments. Trial composite casts AlSi11/CrFe30C8 without electromagnetic field also were performed. Technological parameters of AlSi/CrFe30C8 experimental composite casts was shown in table 4.

Table 3.  
Matrix experiment according to Hartley plan

nr	x <sub>1</sub>	x <sub>2</sub>	x <sub>3</sub>
1.	-	-	+
2.	-	+	-
3.	+	-	-
4.	+	+	+
5.	-	0	0
6.	+	0	0
7.	0	-	0
8.	0	+	0
9.	0	0	-
10.	0	0	+
11.	0	0	0

The technological process of production of trial composite castings were conducted in two stages. In the first stage composite suspension about 10% particle mass participation by mechanical mixing in curcible was produced. The mixing time was 90 [s]. CrFe30C8 particles surface before the introduction of the molten matrix sodium and boron compounds were prepared. In the second stage received composite suspension to shell mould under electromagnetic field cast. Moulds from operating outside, rotating electromagnetic field was performed (Fig. 2). The time of field influence was 120 [s]. Inductor of the electromagnetic field was fed with a current intensity of 5; 7,5; 10 [A]. By inverter the frequency adjusted (50, 75, 100 Hz), what caused regulation of electromagnetic field rotation speed.

In the Figure 3 dimensions of trial composite casts was shown. The trial cast composite samples were taken for metallographic examination. Metallographic specimen were taken for microscopic observation. The morphology and distribution of reinforcing phase in the metal matrix was analyzed. With each cast of 10 samples were cut about 1 cm thick, as shown in figure 3b. Darker faces were analyzed. At each metallographic specimen 13 symmetrical points were determined (Fig. 4).

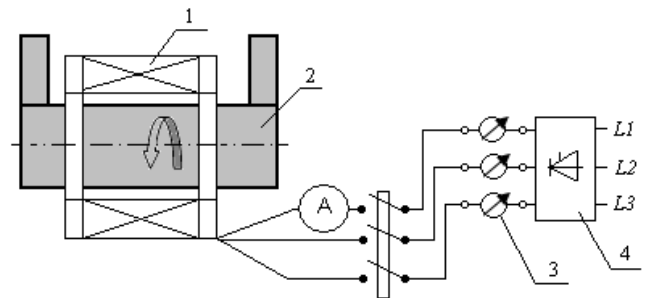
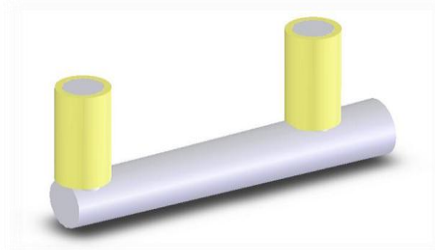

Fig. 2. Diagram of stand to generation of electromagnetic field: 1 – inductor, 2 – shell mould, 3 – autotransformer, 4 - inverter

a)



b)

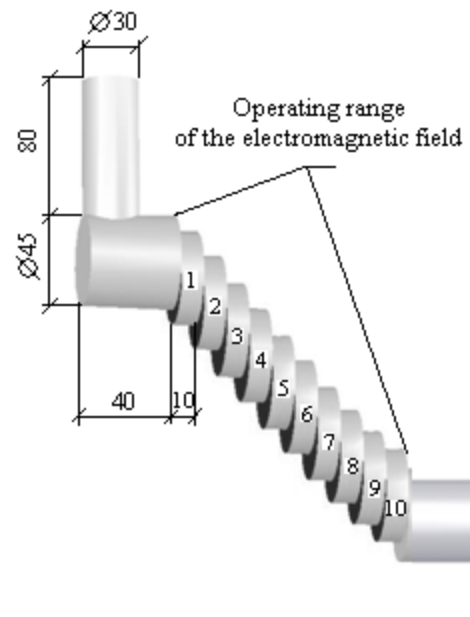

Fig. 3. Preparation method of samples to metallographic testing:  
b) method of samples excision used in tests (1÷10 samples number )

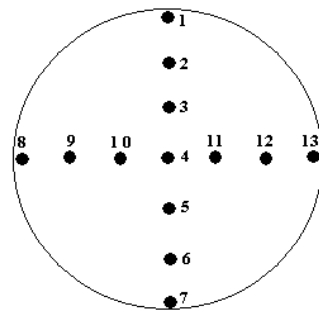

Fig. 4. Measurement points on composites samples

Table 4. Technological parameters production of AlSi/CrFe30C9 experimental composite casts

Technological parameters production of experimental composite casts	Cast number according to experimental design											Casts without electromagnetic field		
	1	2	3	4	5	6	7	8	9	10	11	12	13	14
Particles size, Z [ $\mu\text{m}$ ]	100	100	315	315	100	315	200	200	200	200	200	100	200	315
Frequency, f [Hz]	100	50	50	100	75	75	75	75	50	100	75	-	-	-
Voltage, U [V]	60	50	40	80	60	60	50	70	50	70	60	-	-	-
Current intensity, I [A]	5	10	5	10	7,5	7,5	5	10	7,5	7,5	7,5	-	-	-
Active power, P* [kW]	0,26	0,43	0,17	0,69	0,39	0,39	0,22	0,60	0,32	0,45	0,39	-	-	-
The angular velocity of field rotation, $\omega$ [rad/s]	314,0	157,0	157,0	314,0	235,5	235,5	235,5	235,5	157,0	314,0	235,5	-	-	-
The maximum theoretical speed of movement of metal in the form, V [m/s]	2,4	1,2	1,2	2,4	1,8	1,8	1,8	1,8	1,2	2,4	1,8	-	-	-
The time of field influence, $t_p$ [s]												120	-	-
Matrix temperature during particles introducing $T_{cz}$ [ $^{\circ}\text{C}$ ]												680	680	-
The time stirring particles in crucible, $t_m$ [s]												90	90	-
Pouring temp. $T_z$ [ $^{\circ}\text{C}$ ]												580	580	-

\* - factor of phase shift,  $\cos\phi = 0,86$   
p – number of pole pairs in the inductor,  $p=2$

## 4. The results of investigations

On the basis of quantitative analysis carried out using by computerized image analyzer defined content and distribution of reinforcing phase in the matrix composite. Quantitative analysis revealed differences in the surface portion of reinforcing phase changing along the axis castings (fig. 5).

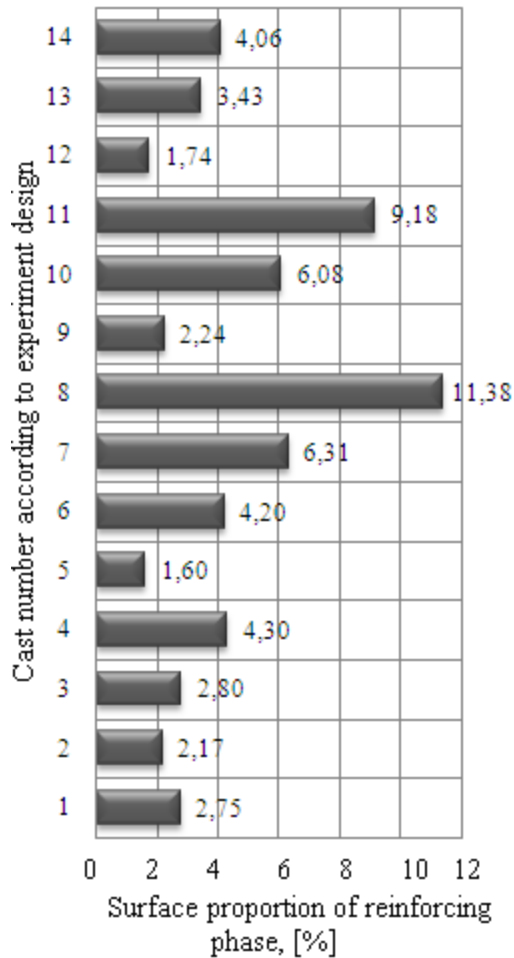

Fig. 5. Surface proportion of reinforcing phase in tests composite casts

In the Figure 5 the mean values share surface reinforcing phase from all areas of measurement the cross section of obtained castings was shown. The smallest percentage of reinforcing phase for casts performed without electromagnetic field (average of 1.74%) was noted. Whereas the largest for castings: 8 (200 $\mu$ m, 75 Hz, 10A – 11,38%), 7 (200 $\mu$ m, 75 Hz, 5A – 6,31 %) and 11 (200 $\mu$ m, 75 Hz, 7,5A – 9,18%). Other casts were characterized by similar shares of the reinforcement.

Clear effect of the electromagnetic field parameters the surface of the reinforcing phase precipitates and their distribution in the matrix was observed (fig. 6). Increasing the current frequency above 75 [Hz] resulted in a decrease in surface area reinforcing phase. The reason for this was the reduction of transition zone phases at the expense of increasing the

participation of Cr and Fe in the  $\alpha$  solution in aluminum matrix of composite.

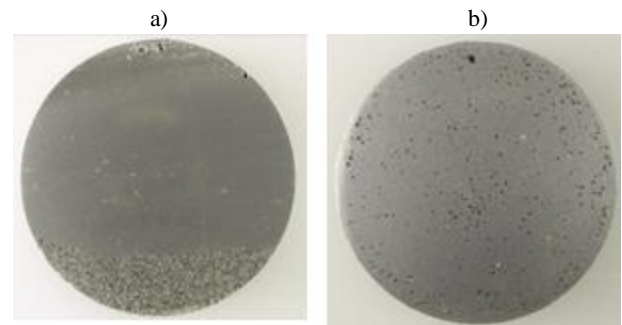
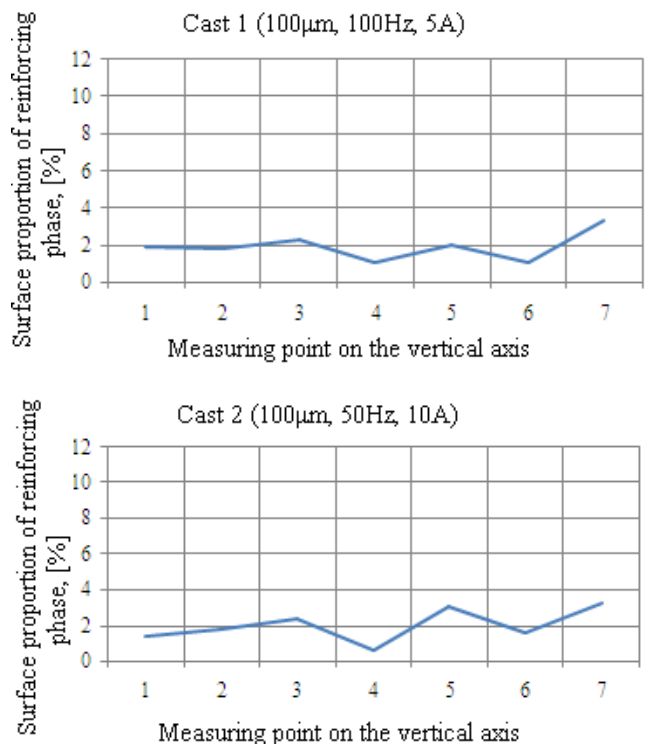
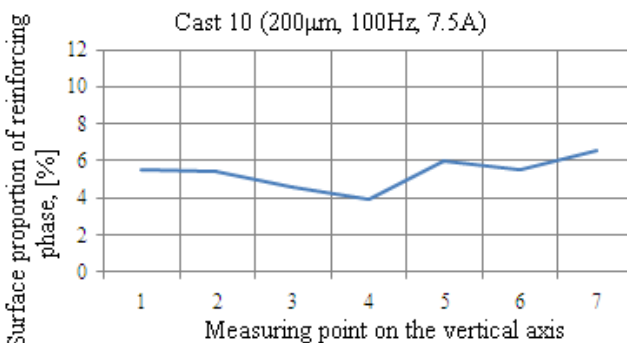
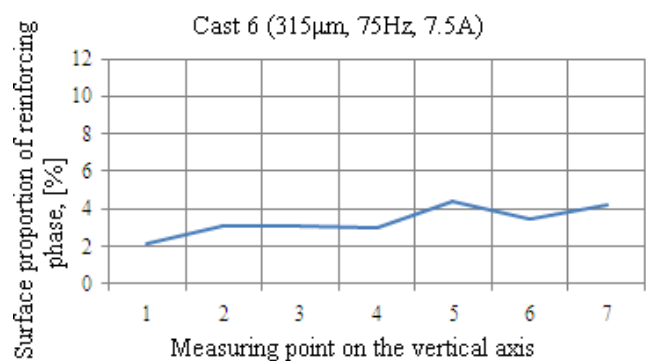
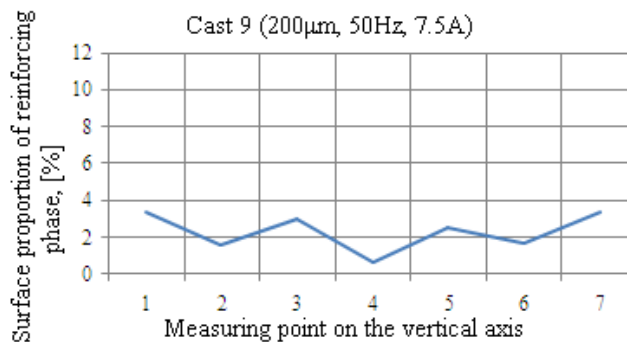
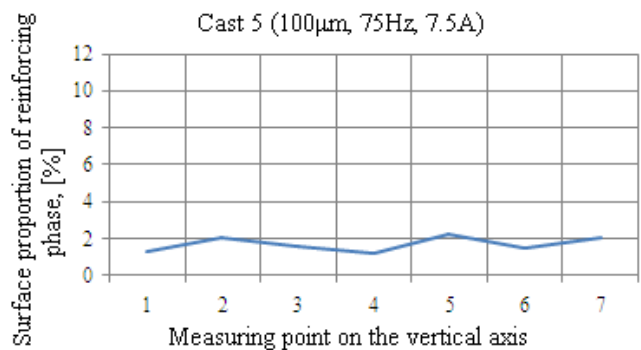
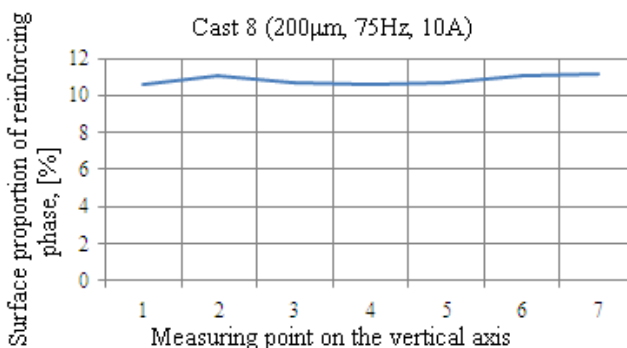
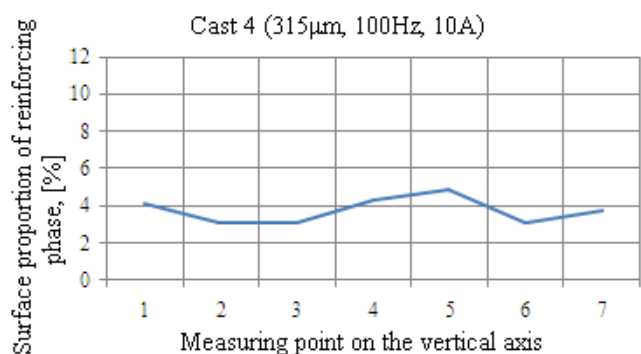
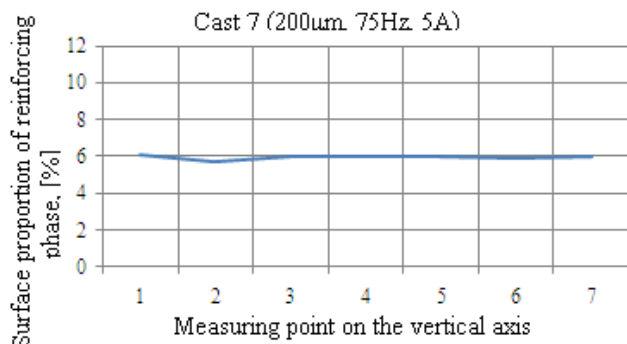
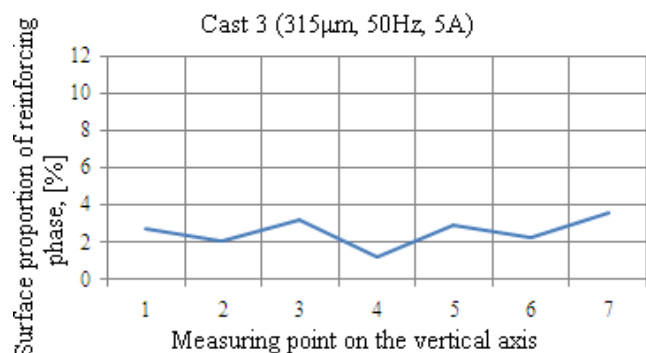

Fig. 6. Example of macrostructure of composite samples: a) without electromagnetic field, b) with electromagnetic field

Next the distribution of surface reinforcing phase precipitates along the vertical axis in produced composite castings was determined. Gravitational segregation of the strengthening phase for measurement points (1 to 7 point) was analyzed. In the figure 7 and 8 results analysis was shown.





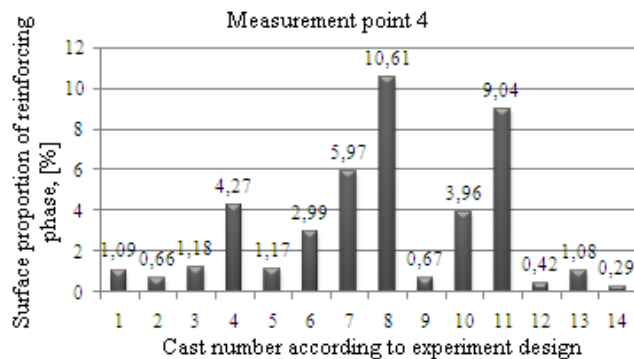
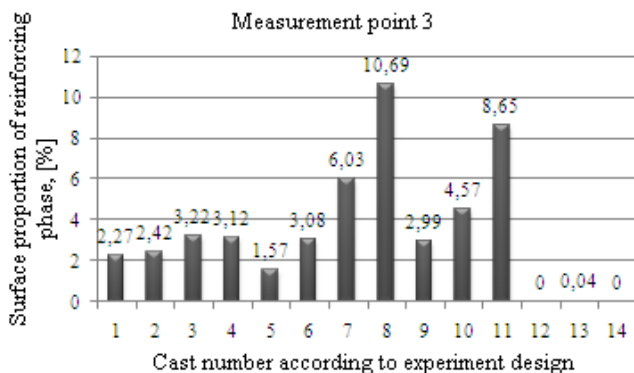
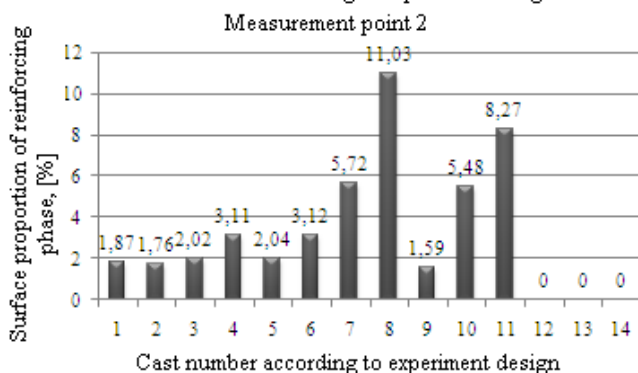
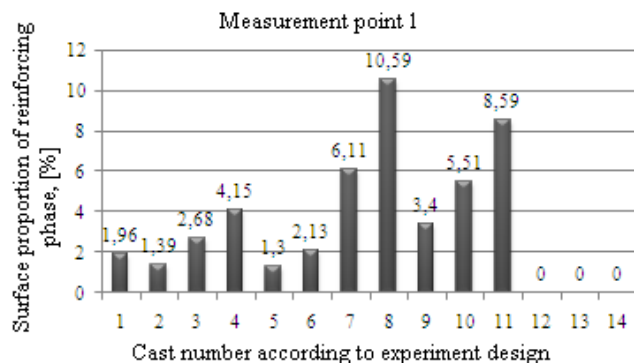
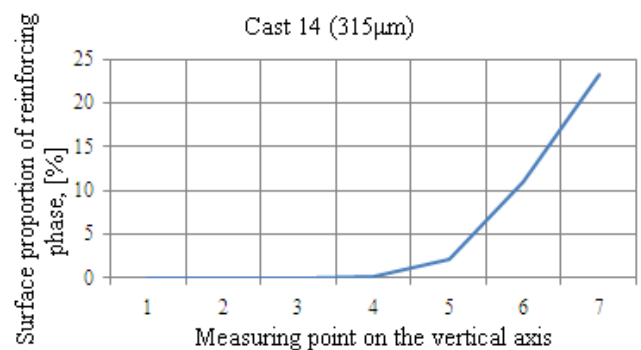
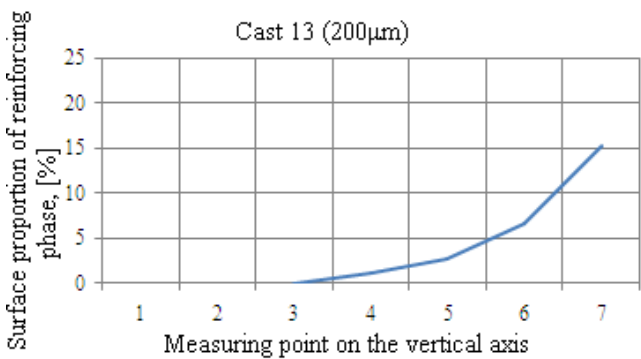
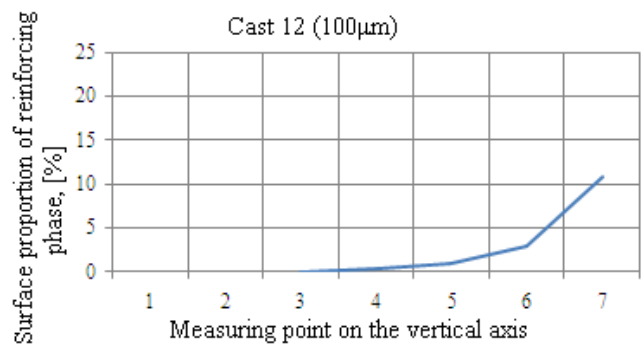
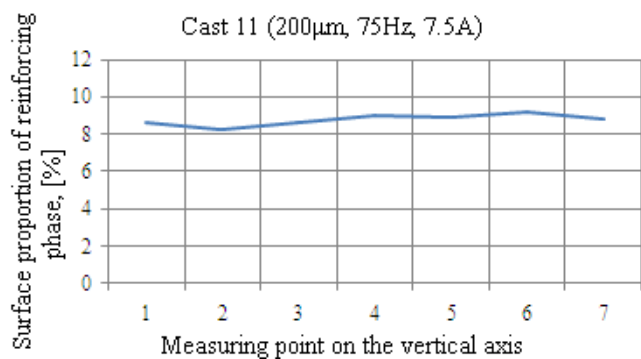

Fig. 7. Gravity segregation of reinforcement phase along height of cast equal to the diameter of the casting trial

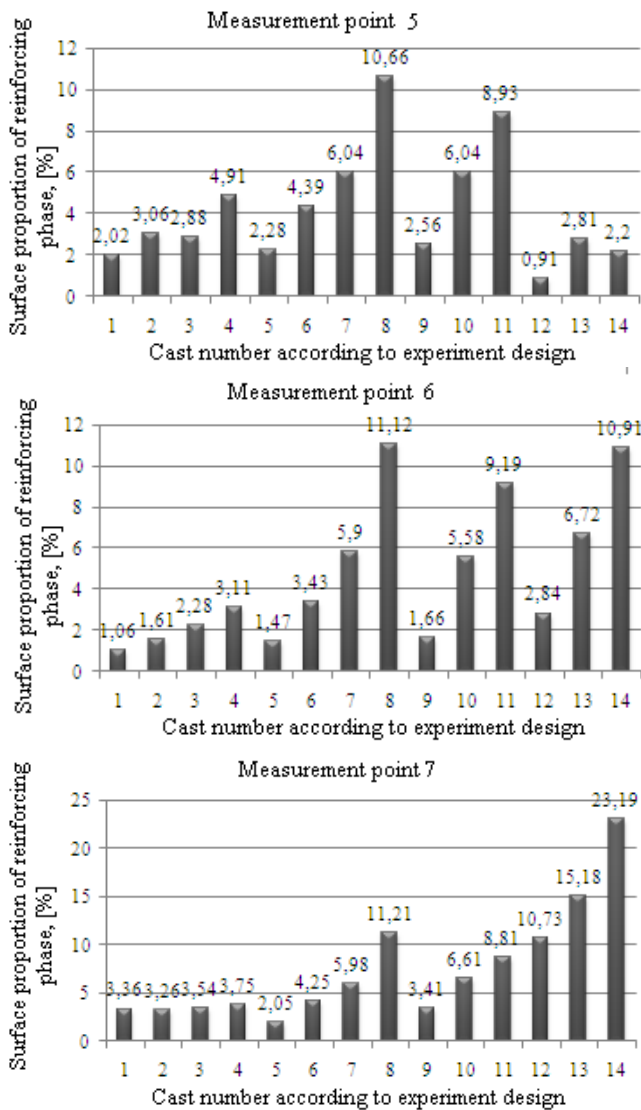

Fig. 8. Distribution of reinforcing phase along vertical axis on the individual measurement points (1÷7) in composite casts

## 5. Conclusions

Based on the analysis of test results most effective technological parameters for casting of composites were found. As in the work [1-2] for composites with the matrix AlSi12Cu2Fe in this case highest average fraction surface phase transition for casts with particulates size was 200 [µm], current intensity 10 [A] and frequency supply current 75 [Hz] were noted. As in the previous stage of research separations were relatively evenly distributed over the entire volume, in relation to other test castings. Assumptions made in the previous stage of research about the best diffusion conditions ferro-chrome particle matrix for matrix composite have been confirmed also for the AlSi11/CrFe30C8 composite castings. By adjusting the relative

velocity components it is possible to intensify the processes of diffusion in the composite. Distribution surface phase separation enhancer along the vertical axis in the resulting casts was specified. A clear influence parameters of electromagnetic field on gravitational segregation strengthening phase in the volume of the casts was noted. The smallest differences in average percentage superficial reinforcing phase along the vertical axis reported for the test castings with the following parameters of the manufacturing process: 200[µm]-75[Hz]-5[A], 200[µm]-75[Hz]-10[A], 200[µm]-75[Hz]-7,5[A]. The results confirmed the assumptions from the previous stages of research, that the particles size 200 [µm] and current frequency 75 [Hz] are the best conditions for particles CrFe30C8. For 75 [Hz] recorded the maximum amount of precipitates reinforcing phase, what was the result of the most favourable particle diffusion matrix. Increasing the frequency to 100 [Hz] resulted in dissolution of the chromium-iron matrix of particles to the aluminium matrix composite, thereby reducing the amount of strengthening phase precipitates.

## Acknowledgments

This research project was financed from support funds for science during 2010-2012. The work done under a promotor grant; Contract number 4863/B/T02/2010/38

## References

- [1] A. Dułęba, M. Cholewa: Segregation reinforced phase in AlSi/Cr<sub>x</sub>C<sub>y</sub> composite cast produced in electromagnetic field, in print.
- [2] A. Dułęba, M. Cholewa: AlSi/CrFeC composite cast produced under electromagnetic field, Supplement of Conference Proceedings, Brno Found – EX 2011, Czechy;
- [3] A. Dułęba, M. Cholewa: Morfologia i segregacja fazy wzmacniającej w odlewanym kompozycie AlSi-CrFeC, Kompozyty 10:3 (2010).
- [4] M. Cholewa: Kinetyka krzepnięcia kompozytów dyspersyjnych, Politechnika Śląska, Zeszyty Naukowe nr 1672, Gliwice 2005.
- [5] M. Cholewa: Ocena cech strukturalnych odlewanach dyspersyjnych kompozytów AlSi-Cr<sub>x</sub>C<sub>y</sub>, Krzepnięcie i Krystalizacja Metali, Kielce-Cedzyna 2008.
- [6] J. Braszczyński, A. Zyska: Problemy krzepnięcia kompozytów odlewanach, Archiwum Technologii Maszyn i Automatykacji, 1998, vol. 18, nr spec.
- [7] Z. Górný, J. Sobczak: Nowoczesne tworzywa odlewnicze na bazie metali nieżelaznych. Wyd. ZA-PIS, Kraków 2005.
- [8] X. -P. Zhang, L. Ye, Y. -W. Mai, G. -F. Quan, W. Wei : Investigation on diffusion bonding characteristics of SiC particulate reinforced aluminium metal matrix composites (Al/SiC<sub>p</sub>-MMC), Composites Part A: Applied Science and Manufacturing, Volume 30, Issue 12, 1999.