

# Optimal LQR controller in CSC based STATCOM using GA and PSO

SANDEEP GUPTA, RAMESH KUMAR TRIPATHI

*Department of Electrical Engineering  
Motilal Nehru N. I. T. Allahabad - 211004, India  
e-mail: jecsandeep@gmail.com*

(Received: 12.03.2014, revised: 06.06.2014)

**Abstract:** The static synchronous compensator (STATCOM) is the multipurpose FACTS device with the multiple input and multiple output system for the enhancement of its dynamic performance in power system. Based on artificial intelligence (AI) optimization technique, a novel controller is proposed for CSC based STATCOM. In this paper, the CSC based STATCOM is controlled by the LQR. But the best constant values for LQR controller's parameters are obtained laboriously through trial and error method, although time consuming. So the goal of this paper is to investigate the ability of AI techniques such as genetic algorithm (GA) and particle swarm optimization (PSO) methods to search the best values of LQR controller's parameters in a very short time with the desired criterion for the test system. Performances of the GA, PSO & ABC based LQR controllers are also compared. Applicability of the proposed scheme is demonstrated through simulation in MATLAB and the simulation results are shown an improvement in the input-output response of CSC-STATCOM.

**Key words:** CSC, FACTS, AI techniques, LQR, STATCOM

## 1. Introduction

In recent years, due to the modification of society along with the rapidly increasing electric power demand, the renovation of urban and rural power network is more and more necessary. During the renovation process of the transmission network, there will be an enormous requirement of reactive power compensation to make the better stability and efficiency of AC transmission networks. Given a profit-driven, decontrolled electric power industry tied with extended load growth, the present construction of power transmission line is being stressed to its upper operating restrictions to achieve higher profit returns to both transmission and generator system owners. In such a scenario, system stability complications such as poor voltage stability and speedy regulation must be determined in the cost-effective manner to get better overall system reliability and security.

In recent decades, all above power quality problems are reduced with the help of high-performance capability of power electronic based equipments. These devices are used for reactive

power compensation in transmission and distribution systems, since their reply is very quick rather than that of the conventional compensators [1]. At the present time, FACTS controllers' family is used to regulate the magnitude of voltage in transmission system with appropriate control topology. STATCOM is the shunt-connected FACTS device that is used to provide reactive power compensation to a transmission line for solving the power quality problems [2]. By their inverter configuration, basic type of STATCOM topology can be realized by either a current-source converter (CSC) or a voltage-source converter (VSC) [3-8]. But recent research confirms several merits of CSC based STATCOM over VSC based STATCOM [9-11]. These advantages contain:

- high converter reliability,
- quick starting,
- inherent short-circuit protection,
- the output current of converter is directly controlled,
- in low switching frequency this reduces the filtering requirements compared with the case of a VSC,
- the dc-side reactor in the current-source converter has a longer lifetime than the dc-side capacitor in the voltage-source converter.

Therefore CSC based STATCOM is very useful in power systems rather than VSC based STATCOM in many cases. Presently the most used techniques for controller design are the proportional integration (PI), linear quadratic regulator (LQR) and pole placement controller [12, 13]. But LQR and pole placement algorithms give quicker response in comparison to PI algorithm and LQR is the optimal theory of pole placement method and describes the optimal pole location based on two cost function [14]. So LQR method gives better performance in these methods.

But in these methods problem is that the best results achieved, because their startup realizations are not simple tasks due to the trial and error method is used to get the weight matrices of LQR algorithm. In such cases, may be tough tuning of the controller parameters in order to find the optimal performance of the system. This problem is eliminated with the help of AI based optimization techniques such as GA and PSO methods.

AI techniques such as GA and PSO are evolutionary computation intelligence techniques that have been proposed to solve the above problem. GA technique is a search method, which is used the idea of natural selection and sexual reproduction to obtain a new population from previous generation [15]. Although a good solution can be obtained by GA method, but it also has some negative aspects. In many cases of optimization problem, other AI technique may give better results than GA in terms of computation time, robustness, parameters adjustment, global search & simplicity etc. [21].

Other hand, Particle Swarm Optimization (PSO) is a population based stochastic optimization algorithm [16]. It has some parallelism with evolutionary computation techniques such as genetic algorithm & Ant colony optimization but the features of PSO, like easy to implement, robust, stable convergence characteristics, best global search ability and to give a better dynamic performance, has made it much superior than others [17, 18].

In this paper, Artificial intelligence technique based LQR controller is proposed to find the best values of two cost function of LQR for the efficient controlling of CSC based STATCOM. Hence, it avoids the trial and error method in the weight matrices of LQR algorithm search. Furthermore, the obtained outcomes of the proposed PSO based LQR are compared to the obtained outcome of the other methods such as GA based LQR & without AI technique based LQR controllers in CSC-STATCOM. More ones, the resulting outcomes from the proposed algorithm based LQR are compared to that obtained from the Artificial Bee Colony (ABC) Algorithm based LQR which are used in previous works [23]. The proposed scheme of this paper is demonstrated through MATLAB simulation.

The rest of the paper is prepared as follows. Section 2 is discussed about the basic principle & circuit modeling of CSC based STATCOM. The design of LQR controller with simulation results is shown in Section 3. In Section 4, proposed LQR controller designs are explained which are based on PSO & GA techniques. Simulation results of the proposed topology are presented in Section 5. Section 5 is shown that the LQR controller based on the PSO method in choosing the Q & R matrices is provided a better control performance and a more systematic & efficient approach compared to the GA, ABC Algorithm & trial and error methods. The comparison results of among these AI techniques such as PSO, GA & ABC Algorithm are also analyzed statistically in this section. Finally, Section 6 concludes this paper.

## 2. System configuration and modeling of CSC based STATCOM

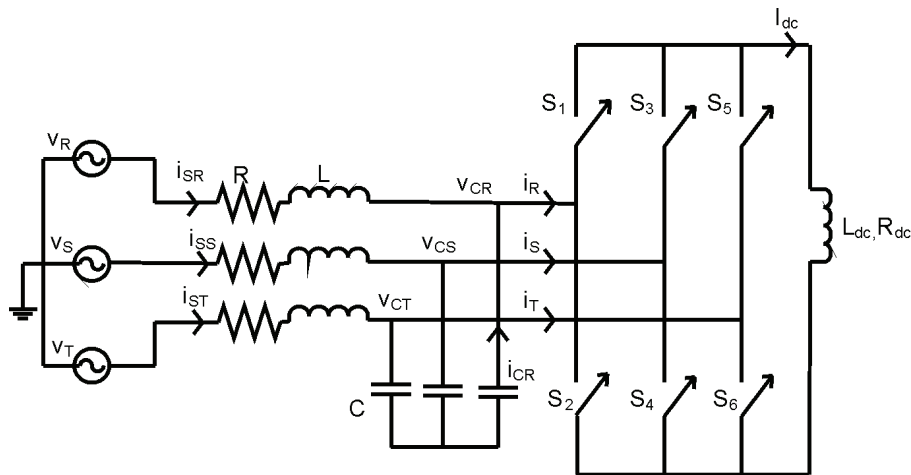

Fig. 1. The representation of CSC based STATCOM

Where:  $i_R, i_S, i_T$  – line current;  $v_{CR}, v_{CS}, v_{CT}$  – voltages across the filter capacitors;  $v_R, v_S, v_T$  – line voltages;  $I_{dc}$  – dc-side current;  $R_{dc}$  – converter switching and conduction losses;  $L_{dc}$  – smoothing inductor;  $L$  – inductance of the line reactor;  $R$  – resistance of the line reactor.

To verify the response of the STATCOM for the dynamic performance, the mathematical modeling and control strategy of a CSC based STATCOM are needed to be present. So in the designing of controller for CSC based STATCOM, the state space equations of the CSC-STATCOM circuit must be introduced. For minimize the complexity of mathematical calculation, the dq transformation theory of currents has been applied in this circuit, which makes the d and q components as independent parameters. Figure 1 is shown the circuit diagram of a typical CSC based STATCOM.

The basic mathematical model of the CSC-STATCOM has been derived in the literature [9]. Therefore, only a brief detail of the test-system is given here for the readers' convenience. Based on the equivalent circuit of the CSC based STATCOM is shown in Figure 1. For the system, we can achieve the differential equations, which are derived in the abc frame and then transformed into the synchronous dq frame using dq transformation method.

$$\frac{d}{dt} I_{dc} = \frac{R_{dc}}{L_{dc}} I_{dc} - \frac{3}{2L_{dc}} M_d V_d - \frac{3}{2L_{dc}} M_q V_q, \quad (1)$$

$$\frac{d}{dt} i_d = -\frac{R}{L} i_d + \omega i_q - \frac{1}{L} \frac{E_d}{n} + \frac{1}{L} V_d, \quad (2)$$

$$\frac{d}{dt} i_q = -\omega i_d - \frac{R}{L} i_q + \frac{1}{L} V_q, \quad (3)$$

$$\frac{d}{dt} V_d = -\frac{1}{C} i_d + \omega V_q + \frac{1}{C} M_d I_{dc}, \quad (4)$$

$$\frac{d}{dt} V_q = -\frac{1}{C} i_q - \omega V_d + \frac{1}{C} M_q I_{dc}. \quad (5)$$

In above differential equations  $M_d$  and  $M_q$  are the two input variables. Two output variables are  $I_{dc}$  and  $i_q$ . Here,  $\omega$  is the rotation frequency of the system and this is equal to the nominal frequency of the system voltage. These equations (1 to 5) are shown that controller for CSC based STATCOM has nonlinear characteristic. This nonlinear property can be removed by accurate modeling of CSC based STATCOM. From equations (1)-(5), we can see that nonlinear property in CSC-STATCOM model is due to the part of  $I_{dc}$ . This nonlinear property is removed with the help of active power balance equation. In the system, we have assumed that the power loss in the switches and resistance  $R$  is ignored. After using power balance equation and mathematical calculation, nonlinear characteristic is removed from the Equation (5). Finally we are obtained the equation below as:

$$\frac{d}{dt} (I_{dc}^2) = -\frac{2R_{dc}}{L_{dc}} (I_{dc}^2) - \frac{3E_d}{L_{dc}n} i_d. \quad (6)$$

In Equation (6) state variable ( $I_{dc}$ ) is replaced by the state variable ( $I_{dc}^2$ ), to make the dynamic equation linear. Finally the better dynamic and robust model of the CSC based STATCOM in the matrix form is derived as:

$$\frac{d}{dt} \begin{bmatrix} (i_{dc})^2 \\ i_d \\ i_q \\ i_{cd} \\ i_{cq} \end{bmatrix} = \begin{bmatrix} -\frac{2R_{dc}}{L_{dc}} & \frac{3E_d}{L_{dc}n} & 0 & 0 & 0 \\ 0 & -\frac{R}{L} & \omega_o & \frac{1}{L} & 0 \\ 0 & -\omega_o & -\frac{R}{L} & 0 & \frac{1}{L} \\ 0 & -\frac{1}{C} & 0 & 0 & \omega_o \\ 0 & 0 & -\frac{1}{C} & -\omega_o & 0 \end{bmatrix} * \begin{bmatrix} (i_{dc})^2 \\ i_d \\ i_q \\ v_{cd} \\ v_{cq} \end{bmatrix} + \begin{bmatrix} 0 & 0 \\ 0 & 0 \\ 0 & 0 \\ \frac{1}{C} & 0 \\ 0 & \frac{1}{C} \end{bmatrix} \begin{bmatrix} I_{id} \\ I_{iq} \end{bmatrix} + \begin{bmatrix} 0 \\ \frac{1}{L} \\ 0 \\ 0 \\ 0 \end{bmatrix} * E_d. \quad (7)$$

Above modeling of CSC based STATCOM is written in the form of modern control methods i.e. State-space representation. In the dynamic modeling of systems, State-space equations are required the three types of variables: state variables(x), input(u) and output variables(y) with disturbance (e). So comparing (7) with the standard state-space representation i.e.

$$\dot{x} = Ax + Bu + Fe, \quad (8)$$

$$y = Cx. \quad (9)$$

We get the system matrices as:

$$x = [I_{dc}^2 \ i_d \ i_q \ V_d \ V_q]^T, \quad u = [I_{id} \ I_{iq}]^T, \quad e = E_d, \quad y = [I_{dc}^2 \ i_q]^T$$

$$A = \begin{bmatrix} -\frac{2R_{dc}}{L_{dc}} & -\frac{3E_d}{L_{dc}n} & 0 & 0 & 0 \\ 0 & -\frac{R}{L} & \omega & \frac{1}{L} & 0 \\ 0 & -\omega & -\frac{R}{L} & 0 & \frac{1}{L} \\ 0 & -\frac{1}{c} & 0 & 0 & \omega \\ 0 & 0 & -\frac{1}{c} & -\omega & 0 \end{bmatrix} \quad B = \begin{bmatrix} 0 & 0 \\ 0 & 0 \\ 0 & 0 \\ \frac{1}{c} & 0 \\ 0 & \frac{1}{c} \end{bmatrix} \quad C = \begin{bmatrix} 1 & 0 \\ 0 & 1 \\ 0 & 0 \\ 0 & 0 \\ 0 & 0 \end{bmatrix}^T \quad F = \begin{bmatrix} 0 \\ \frac{1}{L} \\ 0 \\ 0 \\ 0 \end{bmatrix}.$$

In Equations (8 & 9) five system states, two control inputs and two control outputs are presented. After this, check the stability of the system. So the eigenvalues of the linearized test system are found as it is shown in Figure 2.

These eigenvalues are also marked as x sign in Figure 2. Since all the system's eigenvalues are exist on the left side of the system plane i.e. the system is stable. After this, find the open loop response of input & output variables of the system. These are shown in Figures 3-5 with many big oscillations in  $i_q$  and  $i_d$  during 0-1.5 sec and  $I_{dc}^2$  is not stable.

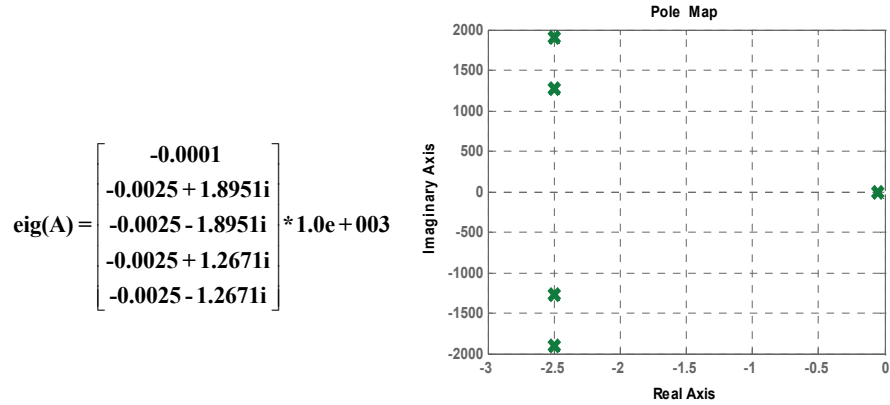
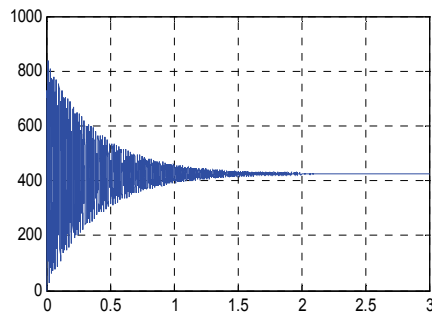
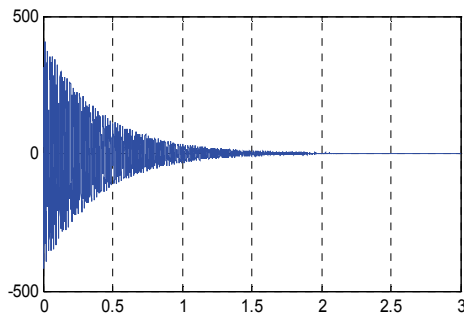
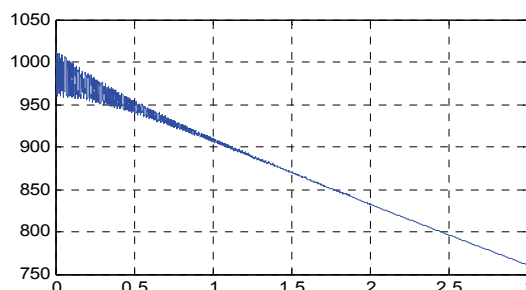

Fig. 2. Poles (x) plotting for the system stability

Fig. 3. Open loop  $i_q$  responseFig. 4. Open loop  $i_d$  response

Since the CSC-STATCOM is used for instantaneous reactive power compensation in the transmission system, so the transient responses of input-output variables of the system should be within one cycle of time period of transmission system [13]. The frequency of this system is 50 Hz, which means that one cycle of time period is about 0.02 s. Thus the transient response of  $i_d$  and  $i_q$  time should be less than 0.02 sec. In this time the dc-side current ( $I_{dc}^2$ ) should be also kept constant.

Fig. 5. Open loop  $I_{dc}^2$  response

When we see the Figures 3-5 for open loop system response, we can notice that some dynamic characteristics of the system must be improved. These characteristics are given below:

- The settling times of  $i_d$  and  $i_q$  are higher than the time necessary (.02 sec.).
- The overshoot of  $i_d$  and  $i_q$  is very high.
- The dc-side current ( $I_{dc}^2$ ) doesn't remain a stable position (some constant value such as 1000 (A)).

Above problems are eliminated with the proper controlling of the test system. So in this paper, the robust and dynamic controlling for CSC-STATCOM is achieved by using the proposed optimized LQR controller. LQR controller is proposed in the next section.

### 3. LQR Controller based CSC-STATCOM design

Linear Quadratic Regulator (LQR) theory is no doubt one of the most basic control system design methods. LQR algorithm is the optimal theory of pole placement method and picks the best possible pole location based on two cost function. This method finds the feedback gain matrix that reduces the cost function. One way of representing the quadratic cost function in mathematically for LQR formulation is below:

$$J = \int_0^{\infty} x^T Q x dt + \int_0^{\infty} u^T R u dt. \quad (10)$$

Here  $Q$  and  $R$  are the symmetric, non-negative definite weighting matrices. For the state-space representation of a given system as below:

$$\dot{x} = A \times x + B \times u + F \times e, \quad y = C \times x,$$

where  $x$  is the state vector,  $u$  is the input vector,  $A$  is the basis matrix,  $B$  is the input matrix,  $e$  is disturbance input.

If we set controller as:

$$u = -Kx + Ty_{ref} + Me. \quad (11)$$

Then the state equation of closed loop can be written as

$$\dot{x} = (A - BK)x + Ty_{ref} + BMe + Fe. \quad (12)$$

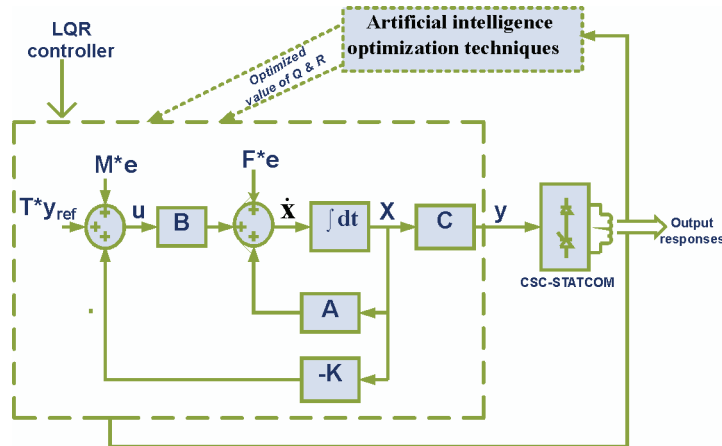

Fig. 6. Control Structure of the proposed controller

So in order to reduce the cost function (performance index) and get the value of gain matrices  $K$ ; two equations are used which are given below:

$$K = R^{-1}B^T P, \quad (13)$$

$$A^T P + PA - PBR^{-1}B^T P + Q = 0. \quad (14)$$

Equation (14) is also called the algebraic riccati equation [19]. The final configuration of the LQR controller for CSC-STATCOM is shown in Figure 6, which is covered by dotted lines.

### 3.1. Simulation Results using LQR method:

In this study, the model of CSC based STATCOM and controllers are developed in MATLAB/Simulink environment. The circuit parameters of the system, which is shown in Figure 1, are mentioned in Appendix I.

To see the system response, we want to shrink the overshoot and decrease the settling time of all three states and reduced the steady state error of the system output responses further such that the requirements are satisfied. In this method, firstly the matrix elements of  $Q$  and  $R$  as  $\text{diag}[Q]$  and  $\text{diag}[R]$  are selected. By trial and error method (TEM), many different sets of  $Q$  &  $R$  matrices for LQR controller are used in the system and to check the stability of the system response. The system responses of all three states ( $i_q, i_d, I_{dc}^2$ ) at different sets of  $Q$  &  $R$  matrices are shown in Figures 7 to 9. Sets of  $Q$  &  $R$  matrices for different LQR controllers are given below:

Case 1 (TEM 1):-

$\text{diag}[Q]$ :-[44.213, 0.1, 5.274, 50.125, 0.564] and  $\text{diag}[R]$ :- [0.207, 0.107]



Case 2 (TEM 2):-

diag [Q]:-[60.14, 2.55, 66.978, 0.333, 0.961] and diag [R]:-[0.434, 0.345]

Case 3 (TEM 3):-

diag [Q]:-[10.004, 0.388, 5.716, 1.18, 1.847] and diag [R]:-[0.964, 0.39]

Case 4 (TEM 4):-

diag [Q]:-[59, 10, 40, .1, 1.9] and diag [R]:-[1.9, 0.4]

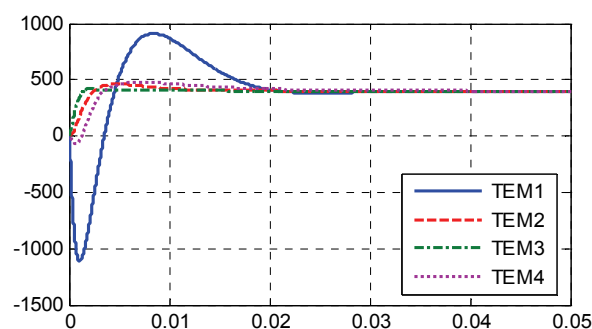

Fig. 7.  $i_q$  response with different LQR controllers (case 1, case 2, case 3, case 4)

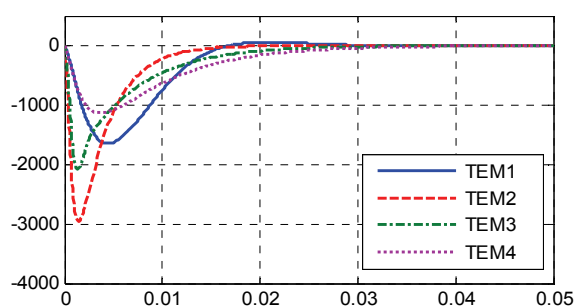

Fig. 8.  $i_d$  response with different LQR controllers (case 1, case 2, case 3, case 4)

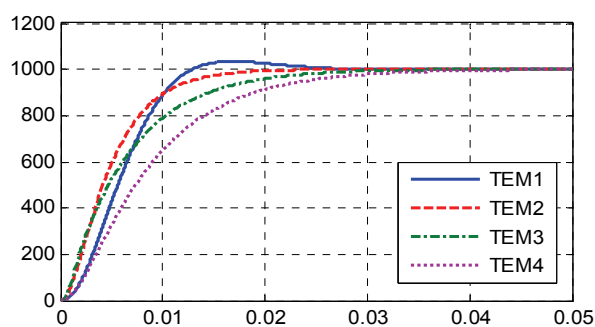

Fig. 9.  $I_{dc}^2$  response with different LQR controllers (case 1, case 2, case 3, case 4)

Among these cases, it can be said that case 2 (TEM2) is given best outcomes from Figures 7 to 9 and Table 3. After seen above results, we can say that the weight matrices of LQR controller have a main dominant role for designing of LQR based CSC-STATCOM. But these values are finding by the trial and error method which is time consuming and laborious. Therefore, AI techniques such as novel online PSO & GA are employed for tuning of Q & R matrices. Now the proposed controller is optimally designed through AI optimization techniques in the next section.

#### 4. Proposed AI Techniques based LQR controller design

Artificial Intelligence (AI) techniques, such as GA (Genetic Algorithm) and PSO (Particles Swarm Optimization), have been applied successfully to design heuristic search algorithms [15]. These both techniques are applied in the LQR controller based CSC-STATCOM and explained as below.

##### 4.1. GA based LQR controller

The use of natural evolution method for the optimization of control system has been of interest for the researchers since a long time. In between, Genetic Algorithm is one of the basic optimization techniques. This is depending on the principles of genetics and natural selection. The basic formation of the GA consists of: firstly choose fitness function, after this coding, then selection of children by elite, crossover (mating), and mutation process to generate the next generation [20].

##### 4.1.1. Use of genetic algorithm for adjusting the state feedback gain matrix (K) in the LQR controller based CSC-STATCOM

Using the genetic algorithm, the state feedback gain with the desired eigenstructure in the LQR controller can be obtained. By the GA, the value of  $K_{GA}$  is optimized by choosing the best values of Q & R. The configuration of the proposed GA based LQR controller for the CSC-STATCOM is shown in Figure 6.

The main content in the GA process is as follows:

*Fitness function:* The performance of the current population is determined by using the fitness function. This is based on the desired requirements of the test system. Fitness function is also called the objective function. The control system objective function in this paper is as follows:

$$Fobj = (10 * Mp + 10 * ts + tr) \quad (15)$$

Where  $tr$  is rise time,  $ts$  is settling time,  $Mp$  is overshoot.

*Reproduction:* In reproduction options, firstly to select parents then produce next set of children based on three operations:

*Elite Count:* In this, to choose the best in the current population.

*Crossover:* In this, to generate children from the combination of two best parents.

*Mutation:* In this, to generate children from the parents with add some fraction value.

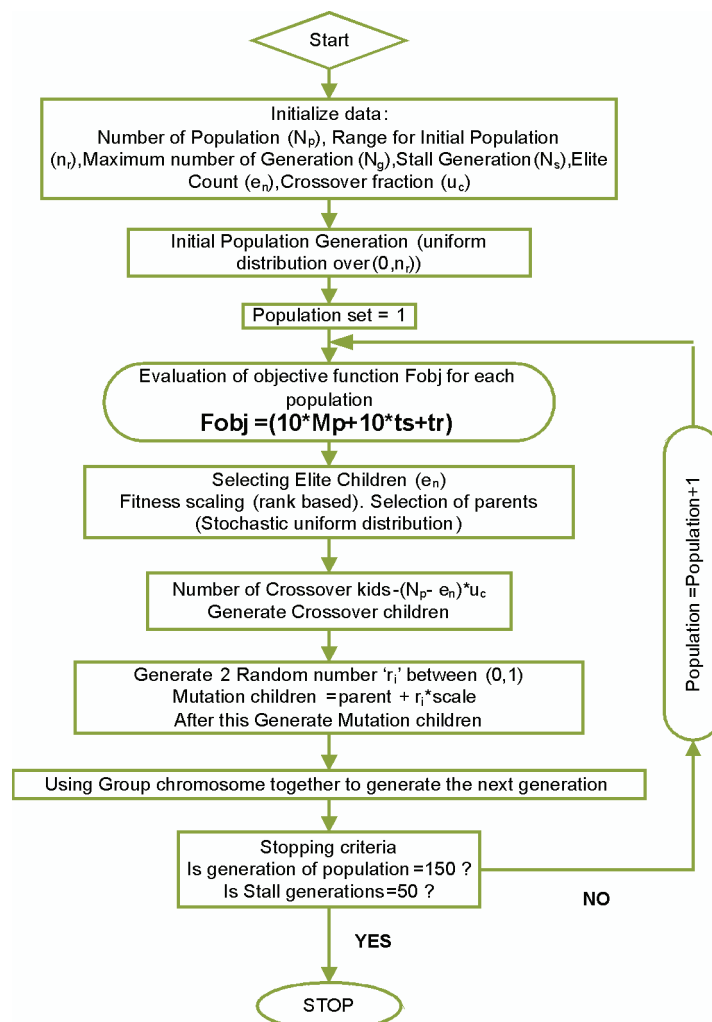

Fig. 10. Steps of Proposed Genetic Algorithm

Once children are obtained, this is considered as a next feasible population. This process goes on and until any of the stopping criteria is reached. Hence, the final best values of Q & R matrices for controller are obtained to the subject of minimum value of pre set fitness function. Above whole process is summarized in the flowchart as shown in Figure 10. Required GA parameters for this process are listed in Appendix I.

After completing the steps of proposed Genetic Algorithm, we find the MATLAB display window which is shown like as Figure 11. The best & mean values at every generation using objective function are found from Figure 11 (a). Seven optimized values for LQR controller are represented in Figure 11(b), which are also given in Table 1.

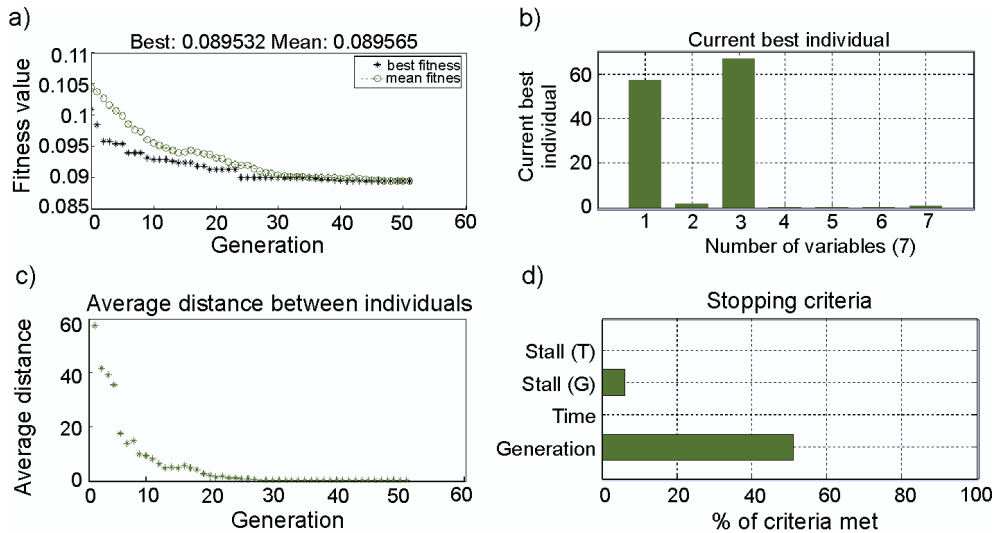

Fig. 11. (a) Best & mean values at every generation, (b) Final 7 best individual values which minimize the cost function, (c) Average Distance between Individuals vs. Number of Generations, (d) Stopping Criterion for the Genetic Optimization

Table 1. Optimal parameters of the LQR controller based CSC-STATCOM using GA method

Parameters of system	Values
Weighting matrix ( $Q$ )	$\begin{bmatrix} 56.26 & 0 & 0 & 0 & 0 \\ 0 & 2.769 & 0 & 0 & 0 \\ 0 & 0 & 63.37 & 0 & 0 \\ 0 & 0 & 0 & 0.63 & 0 \\ 0 & 0 & 0 & 0 & 0.421 \end{bmatrix}$
Weighting matrix ( $R$ )	$\begin{bmatrix} 0.239 & 0 \\ 0 & 0.795 \end{bmatrix}$
Optimal gain matrix ( $K_{GA}$ )	$\begin{bmatrix} -14.3392 & 3.6718 & -1.1340 & 1.8391 & -0.1471 \\ -1.1086 & -0.5504 & 7.9061 & -0.0442 & 1.4487 \end{bmatrix}$
Eigenvalues of test-system ( $\text{eig}(A)$ )	$\begin{bmatrix} -7.140 \\ -0.3104 \\ -1.1232 \\ -3.1658 + 2.969i \\ -3.1658 - 2.969i \end{bmatrix}$

Now, the searching problem for the desired controller parameters is solved out by another AI technique, PSO. In the following section proposed PSO based LQR controller in CSC-STATCOM is considered. After that, comparison in between GA & PSO is also shown.

#### 4.2. PSO based LQR controller

PSO is the nature-inspired heuristic optimization method which first proposed by Kennedy and Eberhart [21]. PSO is based on the social behavior of the certain kinds of animals (such as birds and fish) and solves the optimization problem by the cooperation and competition between the particles to search for globally optimal solutions.

##### 4.2.1. Use of PSO algorithm for adjusting the state feedback gain matrix ( $K$ ) in the LQR controller based CSC-STATCOM

PSO is the stochastic search technique that leads a set of population in solution space evolved using the principles of position and velocity updation. With successive updating new generation, a set of updated solutions gradually converges to the real solution. The updated solutions are found from two evolution equations of particles which are given below:

First is original velocity update equation:

$$V_i^{t+1} = \omega \times V_i^t + \varphi_1 \times r_1 (P_i - X_i^t) + \varphi_2 \times r_2 (P_g - X_i^t). \quad (16)$$

Second is Position Update:

$$X_i^{t+1} = X_i^t + V_i^{t+1}. \quad (17)$$

Where  $P_i$  is the best local search position ( $P_{\text{best}}$ ) of the  $i_{\text{th}}$  particle.  $P_g$  is the best global search position ( $g_{\text{best}}$ ) of the  $i_{\text{th}}$  particle.  $X_i^t$  is the previous position and  $V_i^t$  is the previous velocity of the  $i_{\text{th}}$  particle.  $\omega$  is the inertia weight.

Equation (16) has three parts. First part is represented by previous velocity. The second term is “cognition” part of the particle and “social” part is the third term of the equation. Cognition part represents its personal best experience (position, local search). Social part is also called the group’s best experience (global search). New position of the particle is found by Equation (17). In these equations,  $\varphi_1$  and  $\varphi_2$  are two positive constant which are recommended as the integer values. These constant values are also called study factor.  $r_1$  &  $r_2$  are the random values in between 0 & 1. These values are used to balance the “cognition” component & “social” component. Value of inertia weight ( $\omega$ ) plays the role of balancing the global search and local search.

The fitness function is a particular criterion that is used to evaluate an automatic iterative search in AI techniques such as PSO & GA [17]. So the PSO search algorithm tries to minimize the fitness function through the velocity & position updation process. In this process, the parameters are adjusted to give best value close to the desired response. So fitness function is the main factor in the PSO technique. And the LQR controller is based on the minimization of the cost function. Therefore in this paper, the cost function of LQR is used like as a fitness function of PSO algorithm. This is defined as:

$$\text{Min } J = \int_0^t x^T(t) \times Q \times x(t) dt + \int_0^t u^T(t) \times R \times u(t) dt. \quad (18)$$

Where,  $t$  is the simulation time.  $\text{Min } J$  represents the value of minimum cost function. This is found by optimized  $Q$  &  $R$  matrices. The main objective of PSO technique is minimization

of fitness function to find the optimal values of Q & R matrices for controller gain matrix ( $K_{PSO}$ ). So first  $5 \times 5$  matrix elements of PSO particles are represented Q matrix and last  $2 \times 2$  matrix elements of PSO particles are represented R matrix. Using PSO algorithm, the state feedback gain ( $K_{PSO}$ ) with the desired eigenstructure in the LQR method can be obtained by choosing the best values of Q & R. These optimal values of controller parameters are found as in Table 2. The final configuration of the proposed PSO based LQR for the CSC-STATCOM is shown in Figure 6.

To achieve fine-tuning, the PSO's parameter setting is considered very carefully and important. The set of PSO parameters is mentioned in Appendix I, which are used in this paper.

Table 2. Optimal parameters of the LQR controller based CSC-STATCOM using PSO technique

Parameters of system	Values
Weighting matrix (Q)	$\begin{bmatrix} 57.14 & 0 & 0 & 0 & 0 \\ 0 & 1.559 & 0 & 0 & 0 \\ 0 & 0 & 66.978 & 0 & 0 \\ 0 & 0 & 0 & 0.333 & 0 \\ 0 & 0 & 0 & 0 & 0.361 \end{bmatrix}$
Weighting matrix (R)	$\begin{bmatrix} 0.134 & 0 \\ 0 & 0.945 \end{bmatrix}$
Optimal gain matrix ( $K_{PSO}$ )	$\begin{bmatrix} -20.3956 & 4.1788 & -2.3480 & 1.8296 & -0.3485 \\ -1.2085 & -0.5529 & 7.3734 & -0.0494 & 1.3540 \end{bmatrix}$
Eignvalues of test-system (eig (A))	$\begin{bmatrix} -7.4710 \\ -0.4536 \\ -5.1158 \\ -3.4437 + 3.138i \\ -3.4437 - 3.138i \end{bmatrix}$

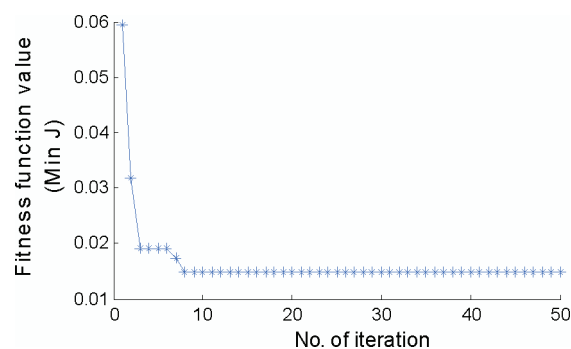

Fig. 12. Convergence behavior of PSO algorithm

Finally, according to a desired fitness function, an optimum set of the Q & R matrices elements are obtained via a Particle Swarm Optimization (PSO) algorithm. After completing

the steps of proposed PSO algorithm and in order to assure excellent tuning of controller parameters, the required outcomes in the input-output response of CSC-STATCOM are obtained in terms of less overshoot, less oscillation, low settling time, and little steady state error which are mentioned in Tables 4 & 5. It can be seen that minimum fitness function (min J) is obtained at 8<sup>th</sup> iteration in Figure 12. Figure 12 is also represented the convergence of PSO.

### 5. Performance of LQR controller based CSC-STATCOM using AI techniques

In this section, the impact of the proposed topology has been observed for the desired criterion of the test system through MATLAB/SIMULINK. The matrix elements of Q and R are used as mentioned in Tables 1 & 2. These values are obtained by the proposed PSO & GA based LQR controllers. The values of Q and R are also found out by Artificial Bee Colony (ABC) Algorithm which has been proposed in previous work [23]. The ABC algorithm is inspired by the collective foraging behavior of honey bee swarms [22]. The optimal values of controller parameters from ABC algorithm are found as in Table 3.

Table 3. Optimal parameters of the LQR controller based CSC-STATCOM using ABC technique

Parameters of system	Values
Weighting matrix ( $Q$ )	$\begin{bmatrix} 60.14 & 0 & 0 & 0 & 0 \\ 0 & 0.559 & 0 & 0 & 0 \\ 0 & 0 & 59.978 & 0 & 0 \\ 0 & 0 & 0 & 0.333 & 0 \\ 0 & 0 & 0 & 0 & 1.023 \end{bmatrix}$
Weighting matrix ( $R$ )	$\begin{bmatrix} 0.434 & 0 \\ 0 & 1.125 \end{bmatrix}$
Optimal gain matrix ( $K_{ABC}$ )	$\begin{bmatrix} -18.4258 & 6.5622 & -2.6593 & 1.7243 & -1.4519 \\ -1.0630 & -0.5408 & 6.9953 & -0.0097 & 1.2366 \end{bmatrix}$
Eigenvalues of test-system (eig ( $A$ ))	$\begin{bmatrix} -6.9855 \\ -0.4021 \\ -4.0297 \\ -2.8924 + 2.871i \\ -2.8924 - 2.871i \end{bmatrix}$

The simulation results of the GA, PSO & ABC algorithm based controllers with CSC-STATCOM are shown in Figures 13-15. Figures 13-15, it is observed that AI techniques based LQR controller are given better results than the trial and error method based LQR controller. Clearly, waveforms of all three states ( $i_q$ ,  $i_d$ ,  $I_{dc}^2$ ) show that PSO based LQR controller is given much improved results than other methods such as GA, ABC algorithms and trial and error method based LQR controllers in Figures 13-15. These comparisons are based on rise time ( $t_r$ ), settling time ( $t_s$ ), overshoot ( $M_p$ ) of the system, which are mention in Tables 4-5.

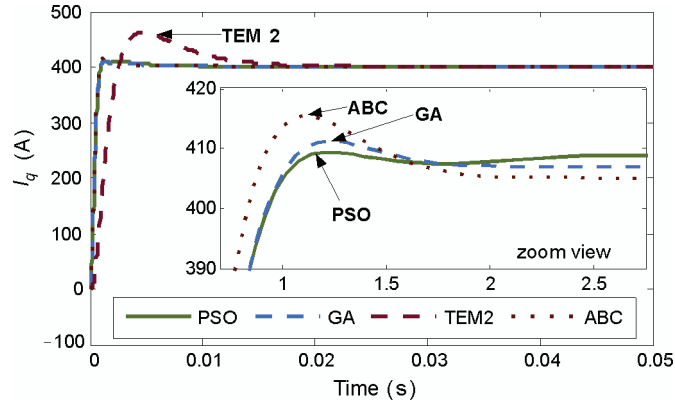

Fig. 13.  $i_q$  response with LQR controller based on PSO algorithm

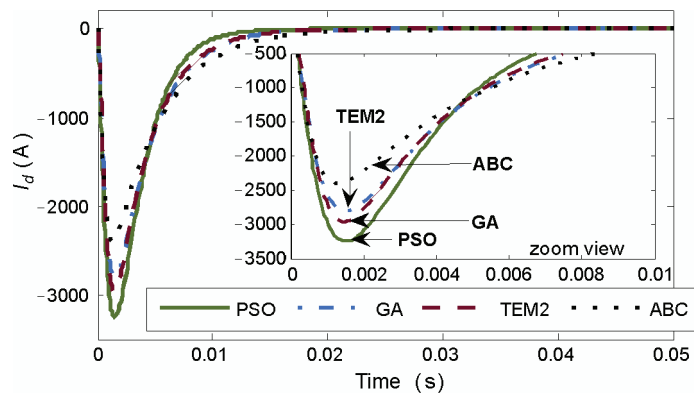

Fig. 14.  $i_d$  response with LQR controller based on PSO algorithm

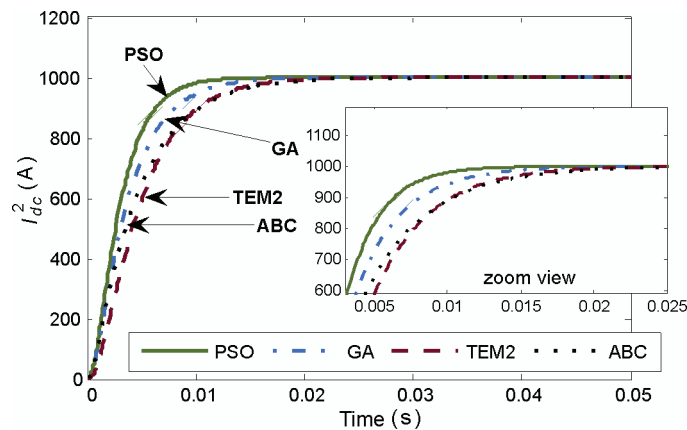

Fig. 15.  $i_{dc}^2$  response with LQR controller based on PSO algorithm



Table 4. System response due to CSC based STATCOM with different topologies

System with different topologies	Case	Output parameters	Rise time (tr) (ms)	Settling time (ts) (sec.)	Overshoot (Mp) %
without LQR controller	open loop	for $i_{dc}^2$ response	2658.5	2.92	33.09
LQR controller	case 1 (TEM1)	for $i_{dc}^2$ response	0.8	0.0213	3.38
LQR controller	case 2 (TEM2)	for $i_{dc}^2$ response	7.0	0.0129	0
LQR controller	case 3 (TEM3)	for $i_{dc}^2$ response	13.2	0.0244	0
LQR controller	case 4 (TEM4)	for $i_{dc}^2$ response	13.4	0.0244	0
LQR controller	with GA	for $i_{dc}^2$ response	6.3	0.0138	0
LQR controller	with PSO	for $i_{dc}^2$ response	5.5	0.0099	$7.64 \cdot 10^{-7}$
LQR controller	with ABC	for $i_{dc}^2$ response	9.6	0.0182	0

Table 5. System response due to CSC based STATCOM with different topologies

System with different topologies	Case	Output parameters	Rise time (tr) (ms)	Settling time (ts) (sec.)	Overshoot (Mp) %
Without LQR controller	open loop	for $i_q$ response	$8.50 \cdot 10^{-1}$	1.55	97.06
LQR controller	case 1 (TEM1)	for $i_q$ response	$8.28 \cdot 10^{-1}$	0.019	127.05
LQR controller	case 2 (TEM2)	for $i_q$ response	0.831	0.0055	4.5
LQR controller	case 3 (TEM3)	for $i_q$ response	2.1	0.021	20.13
LQR controller	case 4 (TEM4)	for $i_q$ response	1.0	0.0033	4.8
LQR controller	with GA	for $i_q$ response	0.612	0.0036	2.14
LQR controller	with PSO	for $i_q$ response	0.56	0.0013	2.09
LQR controller	with ABC	for $i_q$ response	0.546	0.0017	3.90

With regard to the results presented in Tables 2 to 5, it is observed that by applying PSO algorithm in LQR controller; the outcomes of the LQR controller based CSC-STATCOM are improved with desired criterion. From Figure 11 (c) best result from GA is obtained after 20 iterations. But best result from PSO is obtained after 8 iterations. Thus the computational time taken is reduced by PSO technique. In PSO parameters adjustment requirement is also less in comparison to GA algorithm. From Figure 13 to 15, it can be seen that the PSO algorithm has much robustness, less computation time, less parameter adjustment requirement rather than

other AI techniques. And after seeing the data of Tables 1 to 3, it can be also said that PSO is better searching technique than GA or ABC algorithm for LQR controller based CSC-STATCOM, in terms of rise time ( $t_r$ ), settling time ( $t_s$ ), overshoot ( $M_p$ ), computational time.

## 6. Conclusions

The dynamic modeling of CSC based STATCOM and two cost function based LQR controller for the best input-output response of CSC-STATCOM are presented in this paper. Problem in the weight matrices of the LQR controller is also studied. Therefore in this paper, this problem is eliminated by the help of AI techniques, such as GA, PSO & ABC algorithm. The novelty in this paper lies in the fact that, the actual LQR controller performance is optimized with optimal feedback gain matrix ( $K_{PSO}$ ). This makes it possible to achieve the optimum dynamic characteristics of current source converter based STATCOM. Furthermore, the proposed scheme is verified from MATLAB package and compared with simple LQR method. Finally it has been observed that LQR controller with PSO is performed better than other methods such as GA, ABC algorithms & trial and error method based LQR controllers, in terms of rise time ( $t_r$ ), settling time ( $t_s$ ), overshoot ( $M_p$ ), and computational time for the input-output responses of CSC based STATCOM.

### Appendix I

Parameters for various components used in this paper are as follows:

*For LQR controller based CSC-STATCOM:*–

$R_{dc} = 0.01 \Omega$ ;  $L_{dc} = 40 \text{ mH}$ ;  $C = 400 \mu\text{F}$ ;  $R = 0.01 \Omega$ ;  $L = 2 \text{ mH}$ ;  $\omega = 314$ ;  $E_d = 1$

*GA parameters:*–

Number of Population ( $N_p$ ): 20; Range for initial population ( $0, n_r$ ): [0; 1]; Maximum number of Generation ( $N_g$ ): 150; Stall Generation limit ( $N_s$ ): 50; Elite Count ( $e_n$ ): 2; Crossover fraction ( $u_c$ ): .8; Crossover function: Scattered.

*PSO parameters:*–  $\phi_1 = 4$ ;  $\phi_2 = 2$ ; number of population = 10, number of generation (itermax) = 50.

### References

- [1] Ulas Eminoglu, M. Hakan Hocaoglu, Tankut Yalcinoz, *Transmission line shunt and series compensation with voltage sensitive loads*. International Journal of Electrical Engineering Education 46(4): 354-369 (2009).
- [2] Ghosh A., Ledwich G.F., *Power Quality Enhancement using Custom Power Devices*. Kluwer Academic Publishers, Boston, USA (2002).
- [3] Moran L., Ziogas P., Joos G., *Analysis and design of a three-phase synchronous solid-state Var compensator*. IEEE Transactions Industry Application 25: 598-608 (1989).
- [4] Schauder M., Gernhardt, Stacey E., *Operation of  $\pm 100\text{MVAR TVA STATCON}$* . IEEE Transactions Power Delivery 12: 1805-1811 (1997).
- [5] Hingorani N.G., Gyugyi L., *Understanding FACTS: Concepts and Technology of Flexible AC Transmission Systems*. IEEE Press, Piscataway, NJ, USA, pp. 132-133 (2000).

- [6] Gyugyi L., *Application Characteristics of Converter-Based FACTS Controllers*. Proceedings of International Conference on Power System Technology, Piscataway, NJ, USA 1: 391-396 (2000).
- [6] Han B., Moon S., *Static synchronous compensator using thyristor PWM current source inverter*. IEEE Transactions Power Delivery 15: 1285 (2000).
- [7] Gupta S., Tripathi R.K. (2010) *Voltage Stability Improvement in Power Systems using FACTS Controllers: State-of-the-Art Review*. IEEE International Conference on Power, Control and Embedded Systems (ICPCES), pp.1-8 (2010).
- [8] Shen D., Lehn P.W., *Modeling, analysis, and control of a current source inverter-based STATCOM*. IEEE Transactions Power Delivery 17: 248 (2002).
- [9] Kazarni M., Ye Y., *Comparative evaluation of three-phase PWM voltage – and current-source converter topologies in FACTS applications*. Proc. IEEE Power Eng. Soc. Summer Meeting 1: 473 (2002).
- [10] Bilgin H.F., Ermis M., *Current source converter based STATCOM: Operating principles, design and field performance*. Electric Power Systems Research 81(2): 478-487 (2011).
- [11] Wang H., Li F., *Multivariable sampled regulators for the coordinated control of STATCOM ac and dc voltage*. IEE Proceedings Generation, Transmission and Distribution 2(147): 93-98 (2000).
- [12] Ali N., Amin V., *An LQR/Pole Placement Controller Design for STATCOM*. in Proc. Conf. Rec. IEEE CCC, pp.189-193 (2007).
- [13] Rao P., Crow M.L., Yang Z.P., *STATCOM control for power system voltage control applications*. IEEE Transactions Power Delivery 15(4): 1311-1317 (2000).
- [14] Warwick K., Ekwue A., Aggarwal R., *Artificial Intelligence Techniques in Power Systems*. Institution of Electrical Engineers, London (1997).
- [15] Shaheen H.I., Rashed G.I., Cheng S.J., *Application and comparison of computational intelligence techniques for optimal location and parameter setting of UPFC*. Engineering Applications of Artificial Intelligence 23: 203-216 (2010).
- [16] R. C. Eberhart and Y. H. Shi, *Comparison between genetic algorithms and particle swarm optimization*. Evolutionary Programming VII Lecture Notes in Computer Science (Springer), Volume 1447, pp 611-616, (1998).
- [17] Al-Saedi W., Lachowicz S.W., Habibi D., Bass O., *Power flow control in grid-connected microgrid operation using particle swarm optimization under variable load conditions*. International Journal of Electrical Power & Energy Systems 49(1): 76-85 (2013).
- [18] Katsuhiko Ogata, *Modern Control Engineering*. 5th Edition, Prentice Hall (2010).
- [19] Haupt R.L., Haupt S.E., *Practical Genetic Algorithms*. New York: Wiley (2004).
- [20] Shi Y.H., Eberhart R.C., *A Modified Particle Swarm Optimizer*. Proceeding of IEEE International Conference on Evolutionary Computation (ICEC'98), Anchorage, pp. 69-73 (1998).
- [21] Fajar Galih Indarko, Muhammad Abdillah et. al., *Improvement of Dynamic Stability in Single Machine Infinite Bus (SMIB) using Linear Quadratic Regulator (LQR) based Artificial Bee Colony (ABC) Algorithm*. Seminar on Applied Technology, Science, and ARTS 1<sup>st</sup> APTECS, 2009.
- [22] Haiquan Wang, Lei Liao, Dongyun Wang at al., *Improved Artificial Bee Colony Algorithm and Its Application in LQR Controller Optimization*. Hindawi Journal Mathematical Problems in Engineering 2014: 8 (2014).