



# Selection of materials and development of technology for the production of elements used in conditions of extreme tribological wear

D. Wilk-Kołodziejczyk<sup>a,b,\*</sup>, Z. Pirowski<sup>b</sup>, M. Grudzień-Rakoczy<sup>b</sup>, A. Bitka<sup>b</sup>, K. Chrzan<sup>b</sup>

<sup>a</sup> AGH University of Science and Technology, Kraków, Poland

<sup>b</sup> Łukasiewicz Research Network - Kraków Institute of Technology, Poland

\* Corresponding author. E-mail address: wilk.kolodziejczyk@gmail.com

Received 02.08.2021; accepted in revised form 04.10.2021

## Abstract

Work was done as a part of the project "New generation haulage system of highly productive longwall systems" aiming to develop and implement a new longwall shearer system called KOMTRACK. The widely used EICOTRACK feed system developed forty years ago is not adapted to modern longwall shearers' power. Within the project, an innovative, flexible feed system with a modular structure was created with the possibility of continuous adjustment to the carbon wall's unevenness. Newly-developed three cast steels variants have been initially selected to fabricate this system's elements. The material's final selection was realized based on the tensile tests, Charpy impact tests, Brinell hardness surveys, and wear resistance measurements. Results analysis allowed to select cast steel marked as "2", which fulfilled all requirements and was used in further casting trials.

**Keywords:** Wear, Longwall, Shearers, Casting, Shell mold

## 1. Introduction

The flexible structure of the new mining feed system for a longwall shearer, developed by the KOMAG Institute of Mining Technology constructors in Gliwice (leader of the Design Consortium), is made of segments consisting of three essential elements, assumed to be produced as castings. It is a modernized structure developed within the previously realized FLEXTRACK project [1, 2, 3, 4, 5, 6]. Schematically, the segment includes a guide, a closing plate, and a set of toothed elements as shown in Figure 1.

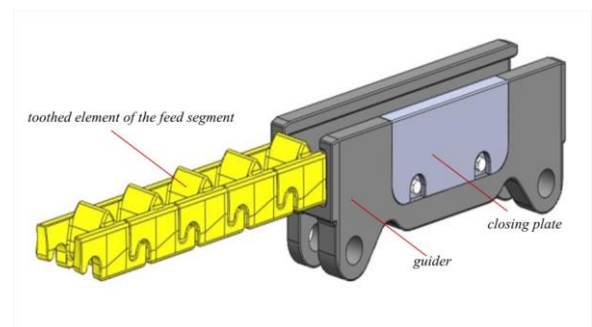

Fig. 1. Construction of the KOMTRACK segment for longwall shearer feed [7, 8]

Based on the performed design calculations and numerically determined operational loads, the following minimum requirements for the castings intended for the new feed system's designed elements were adopted: Rp0.2 - 900 MPa, A - min. 8%, HB - 300. Equally important as the strength of the selected alloy are the tribological properties. They relate to the interaction of the material of the toothed element in the friction pair with the drive wheel under dry friction conditions. The material used for the parts of the drive segment must not significantly impact the wear of the frame wheel in the designed KOMTRACK system than in the EICOTRACK systems used so far. Failure of the combine drive gear is the leading cause of multi-million losses associated with maintenance downtime.

The selection of casting material for elements of various machines and devices is the subject of research work carried out for many years at Łukasiewicz - Krakow Institute of Technology (formerly the Foundry Research Institute). Examples of such activities related to the constructional and material-technological conversion have been described, among other things, for alloys serviced in high-temperature wear conditions [9, 10, 11, 12, 13, 14], and for alloys exposed to abrasive wear, which is the subject of this study [15, 16, 17, 18, 19, 20]. In the case of many elements of machines and devices operating in difficult abrasive conditions, this problem is particularly important. It is being studied by white scientists from various centers around the world. As an example, there are several works published in the specialist journal WEAR [21, 22, 23, 24, 25].

## 2. Experimental procedure

Three grades of abrasion-resistant cast steel have been selected for laboratory tests. They have been chosen from national and

Table 1.

Chemical composition of produced alloys, wt%

Alloy/Element	C	Si	Mn	P	S	Cr	Ni	Mo	V	B
nr „0”	0.24	0.80	0.97	0.014	0.004	0.86	1.18	0.16	-	-
nr „2”	0.25	0.37	1.41	0.023	0.023	1.54	0.05	0.440	-	0.007
nr „4”	0.47	1.76	0.72	0.017	0.012	0.94	1.740	0.570	0.140	-

The chemical composition of the manufactured alloys was verified for compliance with the normative assumptions. All cast alloys were heat-treated under the following procedure:

- Alloy no. 0: 1) annealing: 930 °C/1h/in furnace; 2) austenitization: 910 °C/1h/water; 3) tempering: 250 °C/1h/air;
- Alloy no. 2: a) austenitization: 950 °C/1h/ water; b) tempering: 250 °C/1h/air;
- Alloy no. 4: a) annealing: 930 °C/1h/in furnace; b) austenitization: 890 °C/1h/oil; c) tempering: 310 °C/1h/air + 310 °C/1h/air.

Annealing treatments were carried out in an electric resistance furnace POK73.1. Austenitization and tempering in an electric resistance furnace Multitherm N41/M in an argon atmosphere, (exception in air atmosphere for 250 °C). Mechanical properties of the heat-treated alloys were characterized under international

European standards [26, 27]. Then, these selected model alloys were melted, marking them respectively:

- **alloy no. "0"** - low-manganese cast steel with the addition of chromium, molybdenum, and nickel (according to PN-88/H-83160: Wear-resistant cast steel - Grades),
- **alloy no. „2”** - low-manganese cast steel with the addition of chromium, molybdenum, and boron (according to NF A 32058/1984: Produits de fonderie aciers et fontes blanches moules resistant a l'usure par abrasion),
- **alloy no. „4”** - low-manganese cast steel with the addition of chromium, molybdenum, nickel, silicon, and vanadium (according to NF A 32- 058/1984: Produits de fonderie aciers et fontes blanches moules resistant a l'usure par abrasion).

Model alloys were melted in an open RADYNE induction furnace with a 100 kg metal charge's crucible capacity. A compacted, dried, and sintered crucible made of a refractory neutral ceramic mass was used. For the melts' fabrication, widely available charge materials, deoxidizers and modifiers were used. During the metal's melting, its temperature was controlled by periodic measurements by "B-type thermocouple (PtRh30-PtRh6). The tip of the thermocouple immersed in the liquid metal was protected with self-made covers. The chemical composition of the alloys was controlled at the individual stages of the melting process. The analyzes were carried out using the ARL MA optical emission spectrometer. It took place right after melting the charge to make an appropriate correction of the alloying elements' content, directly after this correction, and then after carrying out the final technological treatments (deoxidation and modification). The results of the final analysis are summarized in Table 1.

standards by a static tensile test at ambient temperature (PN-EN ISO 6892-1:2016-09), Charpy impact test at -40 °C (PN-EN ISO 148-1:2017-02), and Brinell's hardness survey (PN-EN ISO 6506-1:2014). Each test was carried out on a minimum of three samples.

The wear resistance of alloys was evaluated based on dry sliding friction. The pin-on-disc method using a TR-20 tribometer (Ducom) was applied. The TR-20 tribometer is equipped with a friction force sensor and a wear sensor with an accuracy of 0.1 N and 1 μm, respectively. The following test parameters were used in the tests: pin diameter - 3 mm; pressure force - 45 N; rotational speed - 150 min<sup>-1</sup>; test time - 23 h; friction path - 22 780 m; ambient temperature. The samples were pins made of the 20H2N4A steel (drive wheel). The tests were conducted from the side of the carburized surface. Counter-samples (discs) have been investigated alloys for the elements of the feed system: four grades

of cast steel marked: 0, 2, 4 and the reference cast steel "R" (alloy currently used in EICOTRACK systems).

Computed tomography analysis was performed using the v | tome | x L-450. The device is equipped with a lamp with the following parameters: macrofocus®: 450 kV/4500 W, focal length: 2.5 mm or 5.5 mm, max current: 2 mA or 10mA. Maximum resolution (voxel): <math>< 2 \mu\text{m}</math> (depending on sample size). The follow parameters used: voltage: 420 kV; current 395 A; resolution (voxel size) 65.3  $\mu\text{m}$ . Due to the nature of the tests based on a series of X-rays, which cannot penetrate through the thick walls of castings, the analysis was carried out on the samples (cut off by water jet) from most exploited regions of the feed segment - connection of the tooth with the load-bearing part of the casting structure.

### 3. Results and discussion

#### 3.1. Mechanical and tribological properties of cast steels

The produced castings were subjected to mechanical tests, namely static tensile test, impact toughness, and hardness measurements. The obtained mean values and the standard deviation are given in Table 2. Each alloy's yield point exceeds 1400 MPa, and the highest value of 1537 MPa is achieved for variant no. 4. The lowest elongation also characterizes it. The hardness of the alloys is in the range of 340-410 HB. The highest value in the Charpy impact tests is obtained in casting no. "2".

Table 2.  
Mechanical properties of the fabricated cast steels

Alloy	Parameter					Heat treatment recommended by standards
	Rm [MPa]	Rp0.2 [MPa]	A [%]	Z [%]	HB [-]	
no „0”	1484 ( $\pm 23.7$ )	1432 ( $\pm 32.2$ )	9,5 ( $\pm 0.7$ )	-	341 ( $\pm 16.1$ )	normalization, water quenching, tempering
no „2”	1514 ( $\pm 34.8$ )	1415 ( $\pm 24.8$ )	8,4 ( $\pm 0.9$ )	25,1 ( $\pm 3.0$ )	409 ( $\pm 16.8$ )	water quenching, tempering
no „4”	1683 ( $\pm 25.1$ )	1537 ( $\pm 38$ )	2,5 ( $\pm 0.3$ )	4,4 ( $\pm 1.0$ )	349 ( $\pm 23.5$ )	normalization, oil quenching, double tempering

**Rm - tensile strength, Rp0.2 - yield point, A - contraction, Z - elongation, HB - Brinell hardness**

As already mentioned, special attention should be focused on the process of the friction pair's tribological wear: drive wheel/feed segments. It is especially true of the influence of the rack on wheel wear. Therefore, the "pin on disc" tribological tests were performed to reveal the effect of tested alloy on the drive wheel material's degradation in current design solutions. The results of the tribological wear tests carried out by the friction path of 22.5 km

are presented in Table 3. The graphical image of the kinetics of the tested friction pairs' total wear is shown in the corresponding charts shown in Figure 2. Based on the presented results, alloy no. "0" and no. "2" are selected for the castings tests, while alloy no. "4" is rejected.

Table 3.  
Results of tribological tests

Designation of the counter-sample material	Friction coefficient <sup>1)</sup>	Mass loss [mg]	Comparison of the mass loss of a sample compared to a pair with the material "EICOTRACK" [%]	Total wear of the friction pair <sup>1)</sup> [ $\mu\text{m}$ ]	Comparison of the total wear of the friction pair compared to the pair with the material "EICO-TRACK" [%]
No. R <sup>3)</sup> (EICOTRACK)	0.17-0.23	11.14 ( $\pm 0.41$ )	-	219 ( $\pm 14.4$ )	-
No. 0	0.25-0.37	7.92 ( $\pm 0.51$ )	71.1 <sup>2)</sup>	175 ( $\pm 9.0$ )	79.9 <sup>2)</sup>
No. 2	0.06-0.14	10.87 (0.61)	97.6 <sup>2)</sup>	308 ( $\pm 11.8$ )	140.6
No. 4	0.20-0.23	18.14 ( $\pm 1.75$ )	162.8	414 ( $\pm 31.2$ )	189.0

<sup>1)</sup> 1) after the wear process has stabilized - the sample and counter-sample lapping (removal of contact inaccuracies)  
<sup>2)</sup> 2) the criterion assumed in the project is met  
<sup>3)</sup> 3) reference material cut off from the "EICOTRACK" system

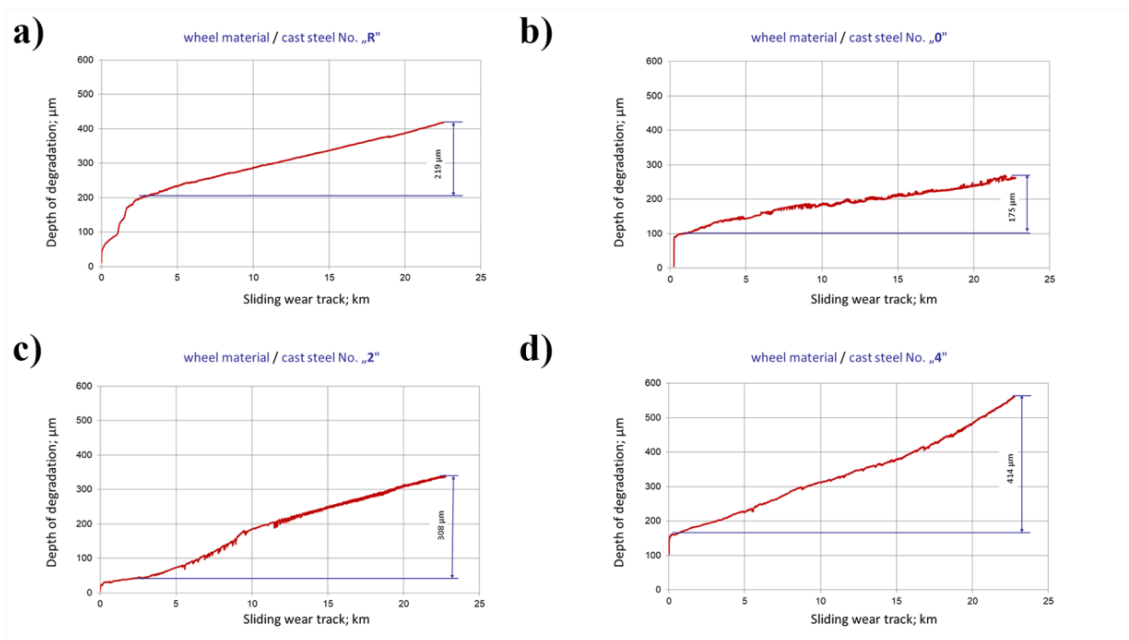

Fig. 2. Kinetics of the total wear of the tested friction pairs

### 3.2. Development of technological assumptions for the manufacturing process

#### Guider frame

As part of the work, based on the guider frame's design drawings delivered by Consortium Lider, technology for making test

castings was developed. The geometry of this component is shown in Figure 3a. It has been assumed that two castings will be cast in one sand mold. The design of such a mold prepared with the MagmaSoft software is shown in Figure 3b, while the simulation of the solidification process is in Figure 3c.

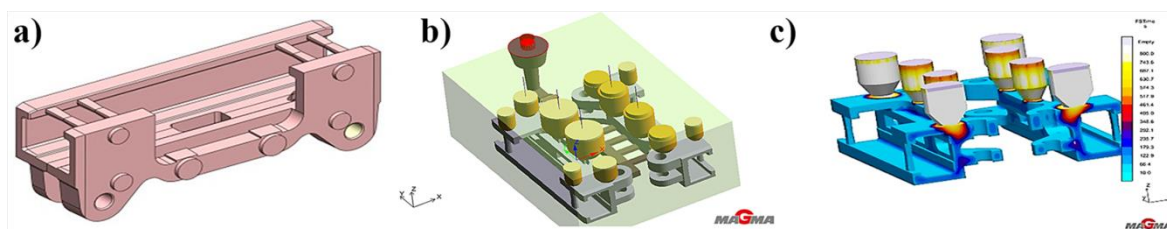

Fig. 3: a) guider frame; b) casting technology of the two guider frames; c) simulation of the casting solidification

The foundry tooling elements developed under the adopted technology are presented in Figures 4a-b (designs of model plates) and 4c-d (designs of core boxes). The method of suitable molds and

cores are shown in Figures 4e-g. The developed casting tooling elements were adapted to the OMEGA molding line, on which preliminary molds for the production of test castings were made.

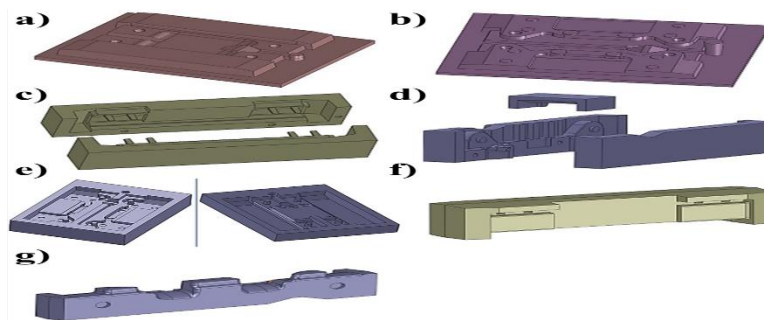

Fig. 4. a) bottom plate; b) top plate; c) large core box; d) small core box; e) casting mold halves; f) large core; g) small core

### Closing plate

As part of the work, based on the closing plate's drawings delivered by the Consortium Lider, the trial castings' technology has also been developed. The location of such a plate in the whole system is shown in Figure 1. It was assumed that four castings of this plate would be produced in one sand mold. The design of this mold made using the Solidworks 2011 software is shown in Figure 5.

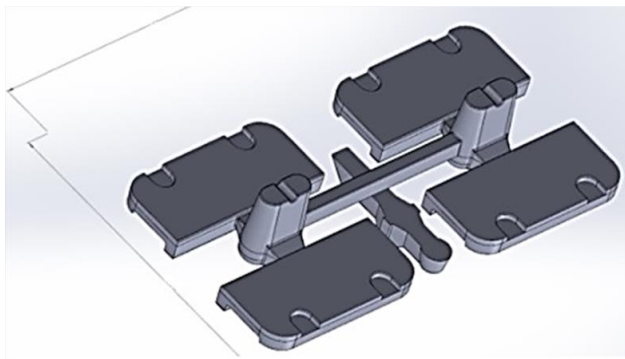

Fig. 5. Casting mold design of the closing plate

Based on this design, foundry models were fabricated by a three-axis CNC plotter, the main elements of which - two halves in the assumed dividing of the mold - are shown in Figures 6, respectively. These models were made of RAKU-TOOL® WB-1460 boards characterized by high density and good abrasion resistance.

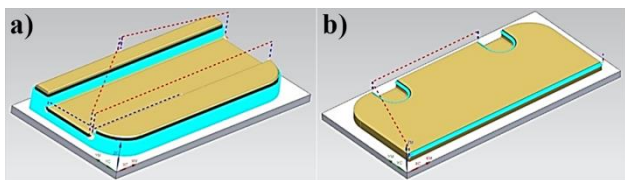

Fig. 6. Foundry model: a) first half; b) second half

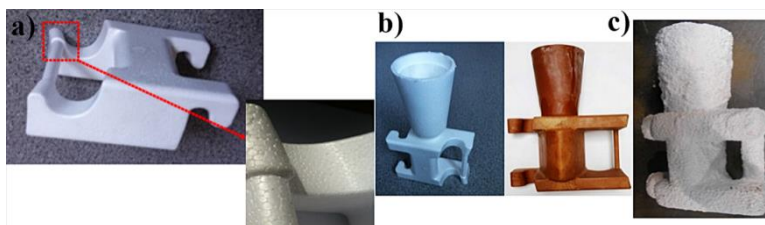

Fig. 8. a) model foamed in a metal die; b) models with a gating system: polystyrene and wax; c) shell mold

The obtained trial castings of the toothed element of the feed segment through three technological variants of molding are shown in Figure 9.

The prepared models were adapted in the molding process on the "OMEGA" device to produce experimental castings. The fabricated casting toolings in the form of 2 model plates are shown in Figures 7.



Fig. 7. Molding in OMEGA device: a) upper model plate for molding; b) bottom plate for the molding

### Toothed element of the feed segment

As part of the work carried out with the segments of the mining feed of the longwall shearer, the technology of producing toothed\_element\_models (wax and polystyrene) and the procedure of casting molds' making were also developed. Selected technologies were tested by making models, molds, and trial castings in three variants:

1. gasified polystyrene models formed in ceramic shells,
2. gasified polystyrene models formed in chemically hardened compounds,
3. wax models.

To verify the adopted technological assumptions and to select the most favorable variant, casting models and preliminary castings were produced. Examples of models made according to the developed technology are shown in Figure 8a, along with the gating system (Fig. 8b) and the shell mold (Fig. 8c).

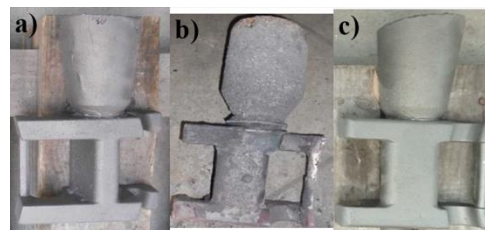

Fig. 9. Casting's variant: a) I; b) II; c) III



Randomly selected castings were tested in terms of their quality. Computed X-ray tomographic analysis showed no internal defects in the tested sample, but only a few slight surface defects. Figure

10 shows an example of the analyzed sample area. Selected sample' tomograms (2D sections) and 3D views are presented in Figure 11.

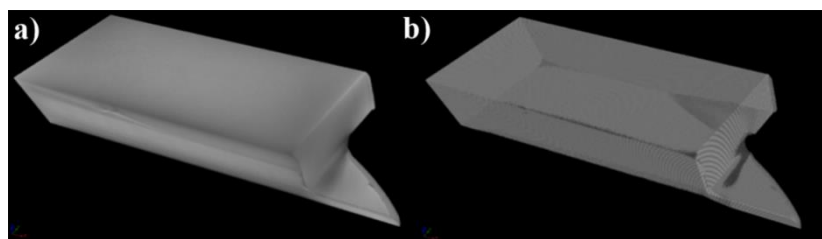

Fig. 10. The analyzed sample of the toothed element of the feed segment (3D):  
a) external view; b) internal view

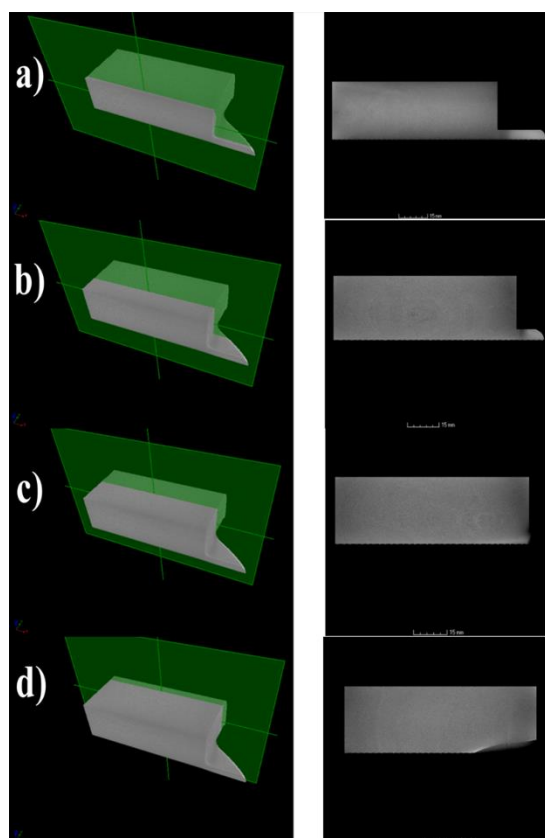

Fig. 11. Examples of the 2D sections and 3D views of the analyzed sample of the toothed element of the feed segment: a, b) area in the -13.88 mm plane from the reference plane; c, d) area in the -2.67 mm plane from the reference plane; e, f) area in the -9.76 mm plane from the reference plane; g, h) area in the 16.98 mm plane from the reference plane

After testing the developed technology of manufacturing individual elements of the mining feed segment of a longwall shearer, a prototype batch of the implemented sections was fabricated at P.I.O. Specodlew Company. Components were sent for operational tests monitored by researchers of the Department of Machine Engineering and Transport of the Faculty of Mechanical

Engineering and Robotics of the AGH University of Science and Technology. A picture of such attempts is shown in Figures 12-13.



Fig. 12. Functionality tests of the constructed test stand



Fig. 13. Tests of wear of the implemented feed system on the constructed test stand

## 4. Conclusions

1. As a result of the analysis, alloy no. "4" was excluded from technological trials carried out at a later stage of the project. It was caused by worse technical parameters (castability, shrinkage), mechanical (low plasticity), and the necessary heat treatments high cost. The alloy no. "2" was considered only a possible material alternative to cast steel no. "0".
2. The tribological tests' analysis shows that the most advantageous alloy is cast steel no. "0" used so far in "EICOTRACK" systems but after modifying the chemical composition and heat treatment parameters. Eventually, replacing it with cast steel no. "2" may turn out to be beneficial when it is necessary to obtain better mechanical properties intended for a given element of the longwall shearer feed system.
3. Based on the evaluation of the initial castings' quality, the type of molding technology was selected for further design works. The technology of polystyrene models requires improvement of the fabrication parameters and preparing necessary safety measures in health and safety. Further experiments on castings of a toothed element of the feed

- segment are carried out using the lost-wax casting technology.
4. The possible continuing of further works on improving the technology based on polystyrene models will depend mainly on the economic factors of castings production: market demand, cost of materials and energy, labor consumption, the cost of adjusting the foundry to health and safety requirements, etc.
  5. The operational tests carried out initially confirmed the correctness of structural and material solutions in terms of strength. Fine coal scattered along the combine's road is an excellent lubricant, making those travels practically silent. The carbon material is pressed by wheel into each hole in the guide and tightly fills the spaces between the feed system's parts.
  6. After disassembly of all specially marked segments, an assessment of their wear will be carried out.

During the tribological tests, the friction coefficient between the sample and counter-sample for all the tested friction pairs did not change significantly in the way of friction, i.e. for over 20 km. The occurring temporary changes of this coefficient are significantly influenced by the occurring and removed abrasion products (figure 14, 15,16,17).

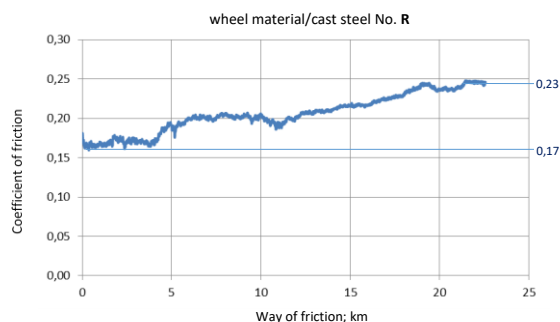

Fig. 14. Coefficient of friction material no R

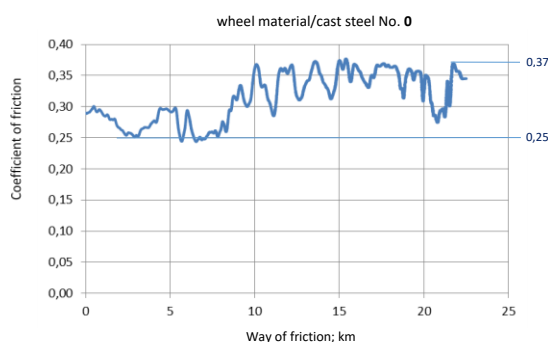

Fig. 15. Coefficient of friction material no 0

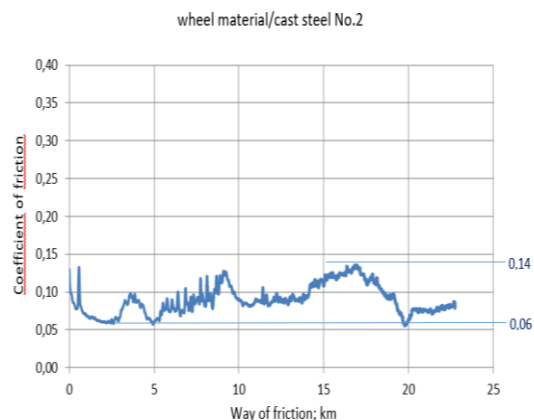

Fig. 16. Coefficient of friction material no 2

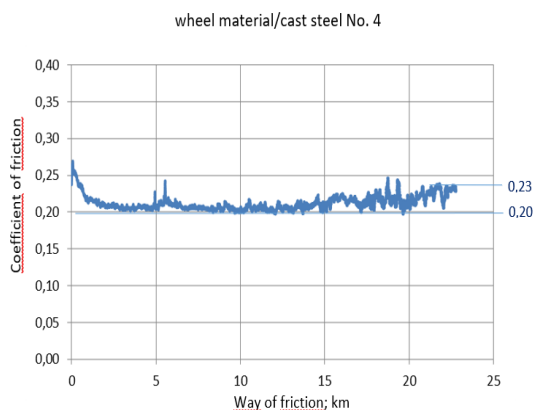

Fig. 17. Coefficient of friction material no 4

## References

- [1] Pirowski Z. (2020). *A new generation feed system for high-performance longwall shearers*. Stage 4; Kraków: Report 2019 – Łukasiewicz Research Network – Foundry Research Institute, 64-69.
- [2] Pieczora, E., Zachura, A., Pirowski, Z., Pysz, S., Kurdziel, P., Żyła, P., Kotulski, W. (2015). *Flextrack - innovative longwall shearer feed system*. Part 1, Modern methods of coal and hard rock mining. Kraków: AGH University of Science and Technology. 185-194. ISBN 978-83-930353-5-9.
- [3] Zachura, A., Pieczora, E., Pysz, S., Żuczek, R., Pirowski, Z., Kurdziel, P., Żyła, P., Kotulski, W. (2015). *Flextrack - innovative longwall shearer feed system*. Part 1, Modern methods of coal and hard rock mining. Kraków: AGH University of Science and Technology, 195-203. ISBN 978-83-930353-5-9.
- [4] Pirowski, Z., Uhl, W., Jaśkowiec, K., Pysz, S., Gazda, A., Kotulski, W., Kurdziel, P., Zachura, A. (2015). *Innovative FLEXTRACK feed system - selection of materials (casting alloys)*, in: A. Klich, A. Kozieł: *Innovative techniques and*

- technologies for mining. Safety - Efficiency - Reliability - KOMTECH 2015, KOMAG Institute of Mining Technology, 223-236. ISBN 978-83-60708-90-3.
- [5] Pysz, P., Żuczek, R., Pirowski, Z., Uhl, W., Kotulski, W., Żyła, P., Kurdziel, P., Zachura, A. (2015). *Innovative FLEXTRACK feed system - development of the technology of making cast segments of the toothed elements and the guider*, in: A. Klich, A. Kozieł: *Innovative techniques and technologies for mining. Safety - Efficiency - Reliability - KOMTECH 2015*, KOMAG Institute of Mining Technology, 237-249. ISBN 978-83-60708-90-3.
- [6] Pirowski, Z., Uhl, W., Jaśkowiec, K., Krzak, I., Wójcicki, M., Gil, A., Kotulski, W., Kurdziel, P., Pieczora, E., Zachura, A. (2015). *Innovative FLEXTRACK feed system - quality assessment of the manufactured prototype castings*, in: A. Klich, A. Kozieł: *Innovative techniques and technologies for mining. Safety - Efficiency - Reliability - KOM-TECH 2015*, KOMAG Institute of Mining Technology, 250. ISBN 978-83-60708-90-3.
- [7] Kalita, M. (2019). Designing process of a toothed segment of the KOMTRACK haulage system. *New Trends in Production Engineering*. 2(1), 121-129. <https://doi.org/10.2478/ntpe-2019-0013>.
- [8] Nieśpiałowski, K., Kalita, M., Rawicki, N. (2019). System for tensioning the toothed path of the longwall shearer's feed system, Scientific and Technical Conference: KOMTECH Innovative Mining Technologies – IMTech.
- [9] Pirowski, Z. (2015). Thermal Analysis in the Technological "Step" Test of H282 Nickel Alloy. *Archives of Foundry Engineering*. 15(1), 87-92. DOI: 10.1515/afe-2015-0016.
- [10] Pirowski, Z., Warmuzek, M., Radzikowska, J. (2012). Test casting Inconel 740 alloy, 70th World Foundry Congress, 560-565.
- [11] Rakoczy, Ł., Grudzień, M., Cygan, R. & Zielińska-Lipiec, A. (2018). Effect of cobalt aluminate content and pouring temperature on macrostructure, tensile strength and creep rupture of Inconel 713C castings. *Archives of Metallurgy and Materials*. 63(3), 1537-1545. <https://doi.org/10.24425/123845>.
- [12] Pirowski, Z., Jaśkowiec, K., Tchórz, A., Krzak, I., Sobczak, J., Purgert, R. (2016). Technological conversion applicable for manufacturing elements from Nickel superalloy H282, 72nd World Foundry Congress, 223-224.
- [13] Grudzień-Rakoczy, M., Rakoczy, Ł., Cygan, R., Kromka, F., Pirowski, Z. & Milkovic, O. (2020). Fabrication and characterization of the newly developed superalloys based on Inconel 740. *Materials*. 13, 2362. <https://dx.doi.org/10.3390%2Fma13102362>.
- [14] Rakoczy, Ł., Grudzień-Rakoczy, M. & Cygan, R. (2019). The influence of shell mold composition on the as-cast macro- and micro-structure of thin-walled IN713C superalloy castings. *Journal of Materials Engineering and Performance*. 28(7), 3974-3985. <https://doi.org/10.1007/s11665-019-04098-9>.
- [15] Grudzień, M., Cygan, R., Pirowski, Z. & Rakoczy, Ł. (2018). Transactions of the Foundry Research Institute. 58, 39-45. <https://dx.doi.org/10.7356/ioc.2018.04>.
- [16] Pirowski, Z. & Gościński, (2013). Casting Alloys for Agricultural Tools Operating under the Harsh Conditions of Abrasive Wear. *TEKA Commission of Motorization and Energetics in Agriculture*. 13(1), 119-126 ISSN 1641-773.
- [17] Pirowski, Z., Gwiżdż, A. & Kranc, M. (2012). Cast Agricultural Tools Operating in Soil. *Tekhnika ta energetika APK*. 170(1), 378-385. ISSN 2222-8618.
- [18] Gościński, M. & Pirowski, Z. (2009). Construction and Technology of Production of Casted Shares for Rotating and Field Ploughs, *TEKA Commission of Motorization and Energetics in Agriculture*. - O.L. PAN, 9(9), 231-239. ISSN 1641-7739.
- [19] Pirowski, Z., Olszyński, J., Turzyński, J. & Gościński, M. (2006). Elements of agricultural machinery working in soil made of modern casting materials. *Motrol*. 8, 169-180. (in Polish).
- [20] Pirowski, Z. (2014). Evaluation of High-temperature Physicochemical Interactions Between the H282 Alloy Melt and Ceramic Material of the Crucible. *Archive of Foundry Engineering*. 14(4), 83-90. <https://doi.org/10.2478/afe-2014-0091>.
- [21] Wang, Z., Huang, B., Chen, H., Wang, CH. & Zhao, X. (2020). The Effect of Quenching and Partitioning Heat Treatment on the Wear Resistance of Ductile Cast Iron *Journal of Materials Engineering and Performance*. 29, 4370-4378. <https://doi.org/10.1007/s11665-020-04871-1>.
- [22] Srinivasu, R., Sambasiva Rao A., Madhusudhan Reddy G., K. Srinivasa Rao, K. (2015). Friction stir surfacing of cast A356 aluminium-silicon alloy with boron carbide and molybdenum disulphide powders. *Defence Technology*. 11(2), 140-146.
- [23] Heldin, M., Heinrichs, J., Jacobson, S. (2021). On the critical roles of initial plastic deformation and material transfer on the sliding friction between metals. *Wear*. 477(Spec.203853). DOI:10.1016/j.wear.2021.203853, Published JUL 18.
- [24] Grzesik, W., Zalisz, Z., Krol, S. & Nieslony, P. (2006). Investigations on friction and wear mechanisms of the PVD-TiAlN coated carbide in dry sliding against steels and cast iron. *Wear*. 261(11-12), 1191-1200.
- [25] Holmberg, K., Matthews, A., Dowson, D. (Ed.) (1998). Coating Tribology. Properties, Techniques and Applications in Surface Engineering. *Tribology Series*. 28, Elsevier, Amsterdam.
- [26] PN-88/H-83160; Wear-resistant cast steel - Grades. (in Polish).
- [27] NF A 32-058/1984: Produits de fonderie aciers et fontes blanches moules résistant à l'usure par abrasion.