

FORMING OF A BIMETALLIC ELEMENT FOR THE RESISTANCE ELEMENT SOLDERING METHOD

KSZTAŁTOWANIE ELEMENTÓW BIMETALICZNYCH METODĄ LUTOWANIA OPOROWEGO

The joining of sheet metal parts produced in the material combination of Fe-Fe, Fe-Al as well as Fe-thermoplastic and Al-thermoplastic can be realized by the Resistance Element Soldering (RES). Extruded bimetallic elements were used to form the overlap joint. The semi-finished product for extrusions was a Cu 99.9 tube with dimensions $\varnothing 6 \times 0.5$ mm and length 9 mm, filled with Sn60Pb40 solder. "T" shaped overprints were produced in two ways. Simulation in the ANSYS software environment was chosen to optimize, select the appropriate forming process, and design the geometry of the functional parts of the forming tool, allowing to use only one extrusion forming operation. The results of the simulations are the magnitudes of stresses and strains, and different head shape geometries of the bimetallic element extrusions of the three proposed forming methods. The task was to achieve extrusions without defects of the Cu tube shell, such as corrugations and wrinkles. The geometry was observed and compared by macroanalysis of extrusion sections made on a laboratory forming tool.

Keywords: RES, extrusion, stress, strain, simulation, forming tool

Łączenie części metalowych wykonanych z połączenia materiałów Fe-Fe, Fe-Al oraz termoplastycznych Fe i Al można wykonać metodą lutowania oporowego (RES - Resistance Element Soldering). Do wykonania połączenia zakładkowego użyto wytłaczanych elementów bimetalicznych. Półfabrykatem do wytłaczania była rura Cu 99,9 o wymiarach $\varnothing 6 \times 0,5$ mm i długości 9 mm, wypełniona lutem Sn60Pb40. Nakładki w kształcie litery „T” wykonywano na dwa sposoby. W celu optymalizacji, doboru odpowiedniego procesu formowania i zaprojektowania geometrii funkcjonalnych części narzędzia kształtującego wybrano symulację w środowisku oprogramowania ANSYS, co pozwala na użycie tylko jednej operacji kształtowania przez wytłaczanie. Wynikiem symulacji są wielkości naprężeń i odkształceń oraz różne parametry geometryczne kształtu głowic wytłoczonych elementów bimetalicznych z trzech proponowanych metod kształtowania. Celem było uzyskanie wytłoczek pozbawionych wad powłoki rury z Cu, takich jak pofałdowania i zmarszczki. Parametry geometryczne obserwowano i porównywano za pomocą makroanalizy produktów wytłaczania wykonanych w laboratoryjnym narzędziu kształtującym.

Słowa kluczowe: lutowanie oporowe, wytłaczanie, naprężenie, odkształcenie, symulacja, narzędzie kształtujące

1. INTRODUCTION

In the production of overlap joints on the framework of automobiles, where it is necessary to join e.g. pressings made of steel with aluminum alloy pressings, the Resistance Element Welding (REW) technology has found application. This is a specific joining of materials with significantly different melting temperature when it is not possible to apply standard fusion welding technologies [1-3]. The principle of the REW technology consists in the use of a T-shaped element with a cylindrical shaft and a head, by means of which an overlap joint of the upper plate with the hole with the lower plate is created by direct

resistance heating (Fig. 1). The element can be made of steel or Al alloy. An unfavorable phenomenon can be (especially in the case of an Al alloy element) the formation of a splash of the element during the resistance heating, which worsens the functional and aesthetic properties of the joint (Fig. 2).

An alternative solution in the formation of some overlap joints of materials with significantly different melting temperature, such as galvanized steel sheet with thermoplastic, can be the Resistance Element Soldering (RES) technology, where a bimetallic element is used (Fig. 3). It consists of a shell that provides a joint with the upper part by a combination of force and shape effect, and a core made of solder.

Corresponding Author: Alexander Schrek, email: alexander.schrek@stuba.sk
Institute of Technologies and Materials, Faculty of Mechanical Engineering, STU Bratislava,
Nám. slobody 17, 812 31 Bratislava, Slovakia

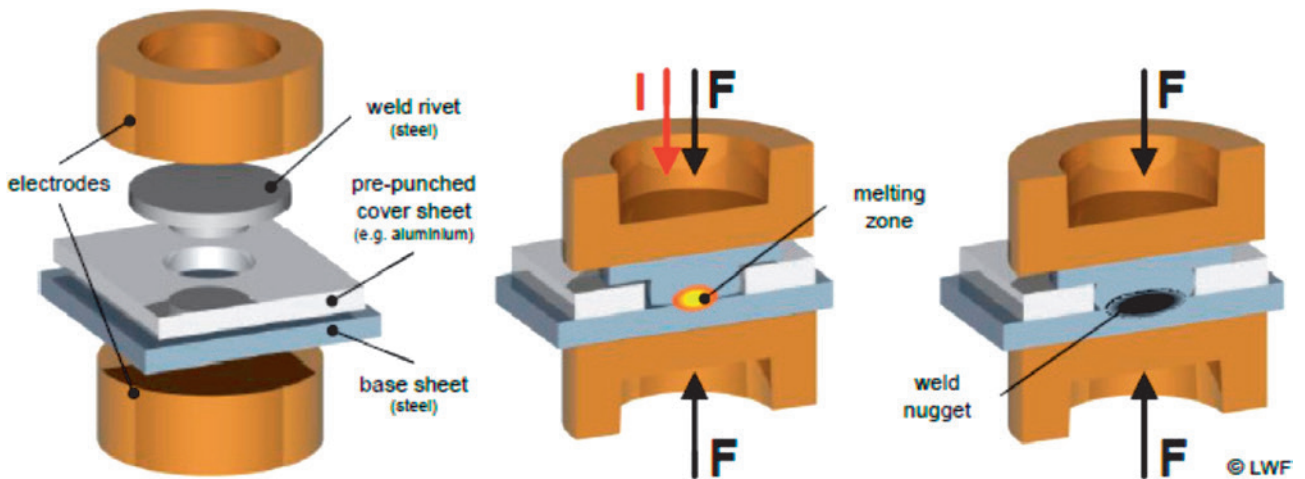

Fig. 1. The principle of welding by REW technology [1]

Rys. 1. Zasada lutowania oporowego [1]



Fig. 2. Splash formation in the REW technology

Rys. 2. Rozbryzgi powstałe w efekcie zastosowania lutowania oporowego

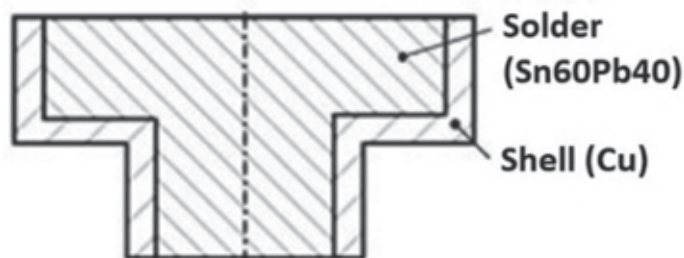

Fig. 3 Construction of bimetallic element

Rys. 3. Budowa elementu bimetalicznego

The joint between the element and the metal sheet thus does not take place by a fusion welding, but by soldering. The lower heat input during soldering allows, on the one hand, the joining of materials with a low melting or thermal decomposition temperature (e.g. thermoplastics), and on the other hand, reduces

the level of heat-induced stresses and strains that occur during heating and cooling.

The semi-finished product for the manufacturing of bimetallic elements consists of a tube filled with solder (Fig. 4 left). When choosing the material combination, a shell (tube) made of 99.9% Cu with

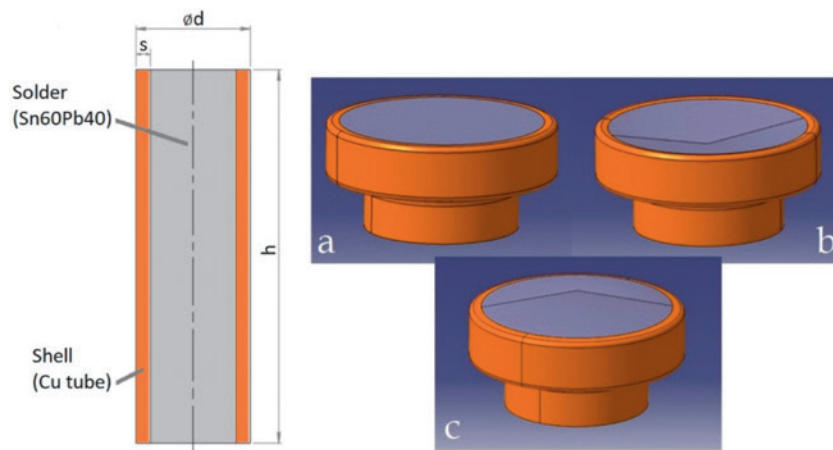

Fig. 4. Bimetallic semi-finished product (left) for the manufacturing of bimetallic elements for RES (right) with flat (a), convex (b), and concave (c) head

Rys. 4. Półfabrykat bimetaliczny (po lewej) do wytwarzania elementów bimetalicznych do lutowania oporowego (po prawej) z głowicą płaską (a), wklęsłą (b) i wypukłą (c)

an outer diameter (d) of 6 mm and a wall thickness (s) of 0.5 mm was designed. The core consisted of Sn60Pb40 solder. The tube filled with solder was divided into a length (h) of 9 mm to ensure the desired shape and size of the element according to Fig. 4 right.

2. MATERIAL PROPERTIES OF THE BIMETALLIC ELEMENT

The boundary conditions for the simulation of the element head shaping were the stress-strain properties of both materials of bimetallic semi-finished product. They were obtained by a tensile test on the

INSTRON 1195 machine. The measured and calculated values are in Tab. 1.

3. TECHNOLOGICAL PROCEDURES OF BIMETALLIC ELEMENT PRODUCTION

Cold forming was chosen for the manufacturing of the element. Creating an element head can be done in several ways. The first method was upsetting in a closed die. The die and ejector (in the bottom of the die) were fixed, the head of the die was upset by a smooth movement of the punch from top to bottom (Fig. 5). The shape of the punch face corresponds to the desired shape of the element head. However, due

Table 1. Stress-strain properties of both materials of bimetallic semi-finished product

Tabela 1. Właściwości naprężeniowo-odkształceniowe obu materiałów półfabrykatu bimetalicznego

Material	Density [g·cm ⁻³]	Yield strength R_e [MPa]	Tensile strength R_m [MPa]	Elongation A_{Re} [%]	Elongation A_{Rm} [%]	Young Modulus [GPa]	Poisson ratio [-]	Tangent Modulus [MPa]
Cu	8.94	108.2	252.8	0.03	28.24	130	0.34	512.77
Sn60Pb40	8.5	40.2	61.5	1.3	10.8	3.01	0.38	224.32

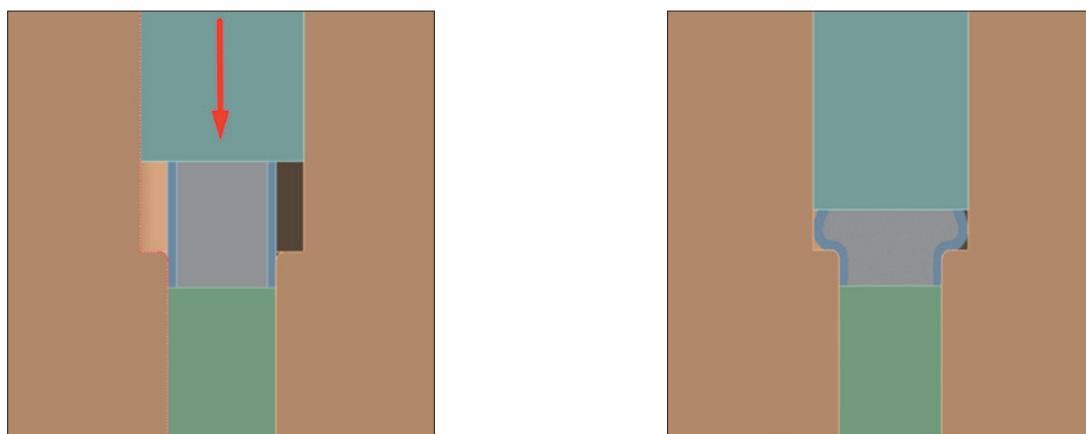

Fig. 5. Upsetting in a closed die

Rys. 5. Deformacja w zamkniętej matrycy

to the use of one operation, this method led to defects in the transformed area. A preparatory operation increasing the buckling stiffness of the semi-finished product was not used.

In Fig. 6 is the joint obtained in the first experiments, which shows significant defects of the bimetallic element in the form of wrinkles and the eccentricity of the shell. Blow holes also appeared in the solder, which are a metallurgical problem and are not the subject of this paper.

To eliminate the defects of the elements, an alternative method which made possible to achieve the desired shape of element in one forming operation without their occurrence was chosen. This method used forward extrusion in a closed die [4, 5]. The extrusion die and punch are fixed (shape of the punch face corresponds to the desired shape of the element head) and the flat ejector, which serves as a low-

er punch, moves from bottom to top, forming the semi-finished product of Fig. 7.

4. SIMULATION OF TECHNOLOGICAL PROCESS

The boundary condition for the simulation of the element head formation was the simplified model of the tool geometry (Fig. 8). The removal of the wrinkles and the eccentricity of the element shell was solved by choosing different geometry of the punch face directing the material flow, as well as by mutual movement of individual parts – semi-finished product and tool in forming the element head [6–8]. In the designed and verified process, the semi-finished product moved against the punch forming the head of the element (Fig. 7). The punch face was flat (Fig. 9a),

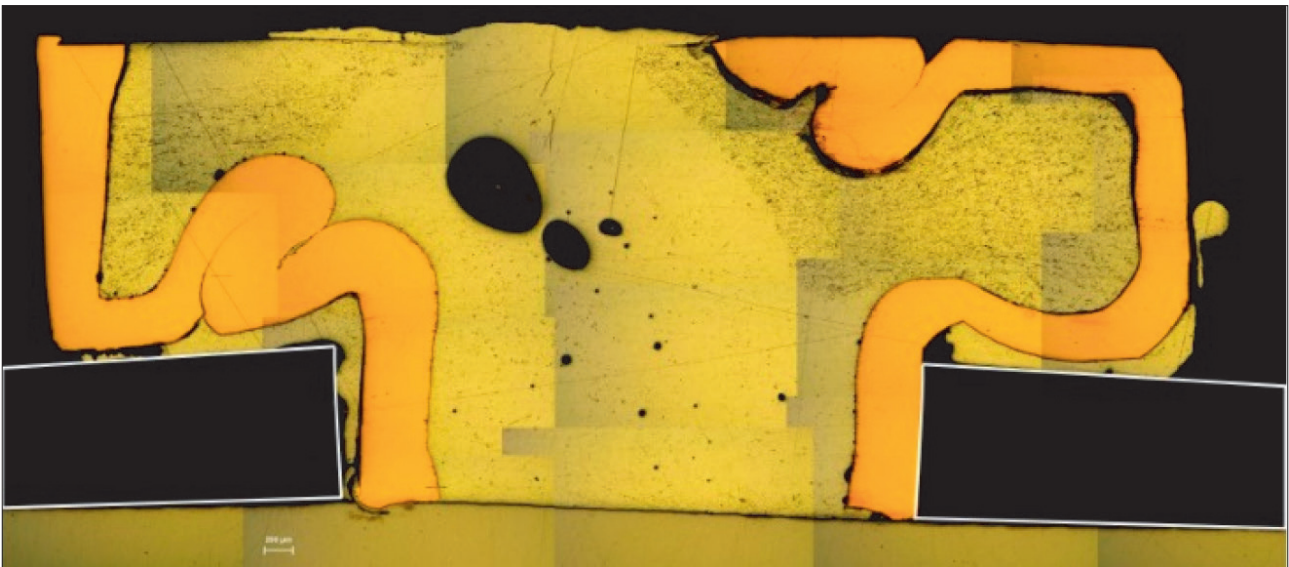

Fig. 6. Joint of plastic and galvanized steel sheet by using bimetallic element with defects in the form of wrinkles and eccentricity of the shell

Rys. 6. Połączenie tworzywa sztucznego i blachy ocynkowanej za pomocą elementu bimetalicznego z defektami w postaci zagnieceń i pofałdowań powłoki

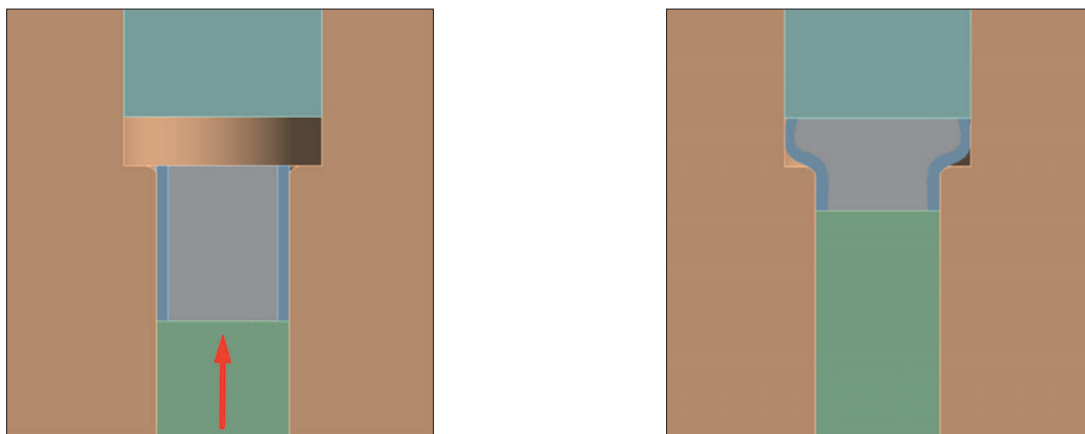

Fig. 7 Forward extrusion in a closed die

Rys. 7. Wytłaczanie współbieżne w zamkniętej matrycy

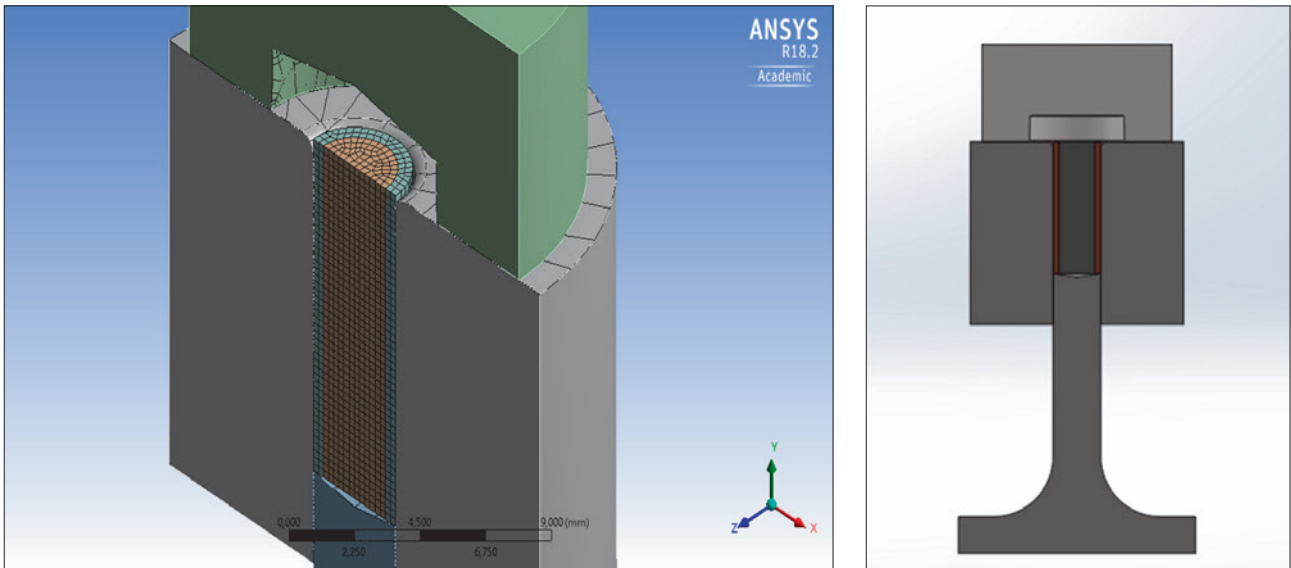

Fig. 8. Simplified model of the simulation tool with the semi-finished product inside
Rys. 8. Uproszczony model narzędzia do symulacji z półfabrykatem w środku

concave at an angle of $+10^\circ$ (Fig. 9b), or convex at an angle of -10° (Fig. 9c). The purpose of the concave or convex shape is to guide the strain of the shell.

ANSYS R18.2 software was used to simulate stresses, bimetal deformations, total deformations, and extrusion appearance [9]. In addition to the tool geometry (Fig. 8) and stress-strain properties of the

materials (Tab. 1), the boundary conditions were the speed of movement of the semi-finished product $v = 2.67 \text{ mm}\cdot\text{s}^{-1}$, the coefficient of friction $f = 0.1$, meshing of the element = 0.25 mm, temperature $T = 20 \text{ }^\circ\text{C}$ and defining the material interface of the bimetal by the Rough function.

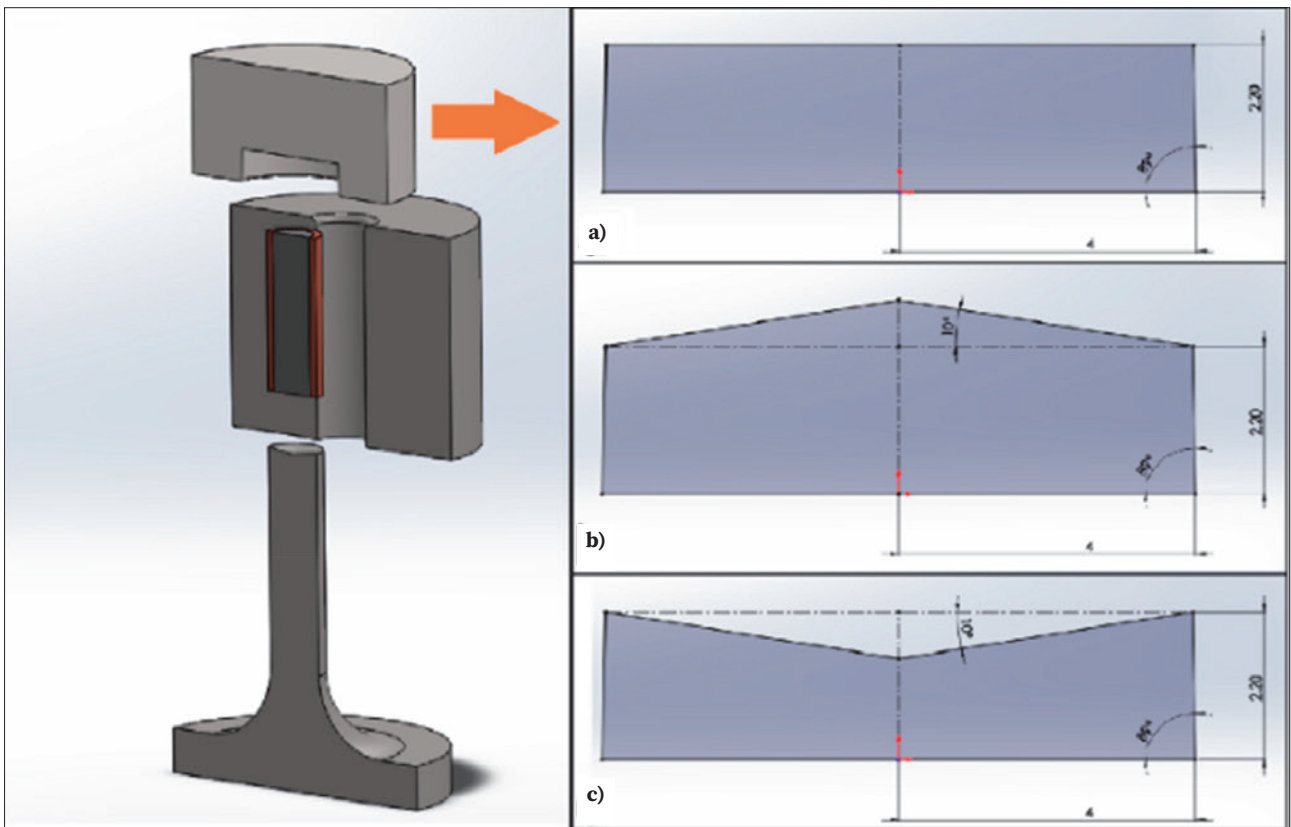

Fig. 9. Tool shapes for the different element heads – flat (a), concave (b), and convex (c)
Rys. 9. Kształty narzędzi dla różnych głowic elementów - płaskie (a), wypukłe (b) i wklęsłe (c)

The magnitude and distribution of the stresses generated during the formation of the element head is documented in Fig. 10. According to the simulation, stresses of up to 836 MPa are required to perfectly fill the die cavity in the corners. The simulations did not show any signs of wrinkles and the stress distribution is axially symmetric. The course of stresses for individual shape alternatives depending on the stroke and time of movement of the lower punch is shown in Fig. 11.

The magnitude and distribution of the resulting strains of bimetallic semi-finished product during

the formation of the element head is documented in Fig. 12. The largest strain is at the point of greatest cross-sectional change. Shellstrain (thinning and thickening of the wall thickness) of the Cu tube corresponds to changes in cross-section.

The magnitude and distribution of the total strains of the element when forming the head is documented in Fig. 13. The largest strain is at the point of greatest cross-sectional change. Shaft strain is zero.

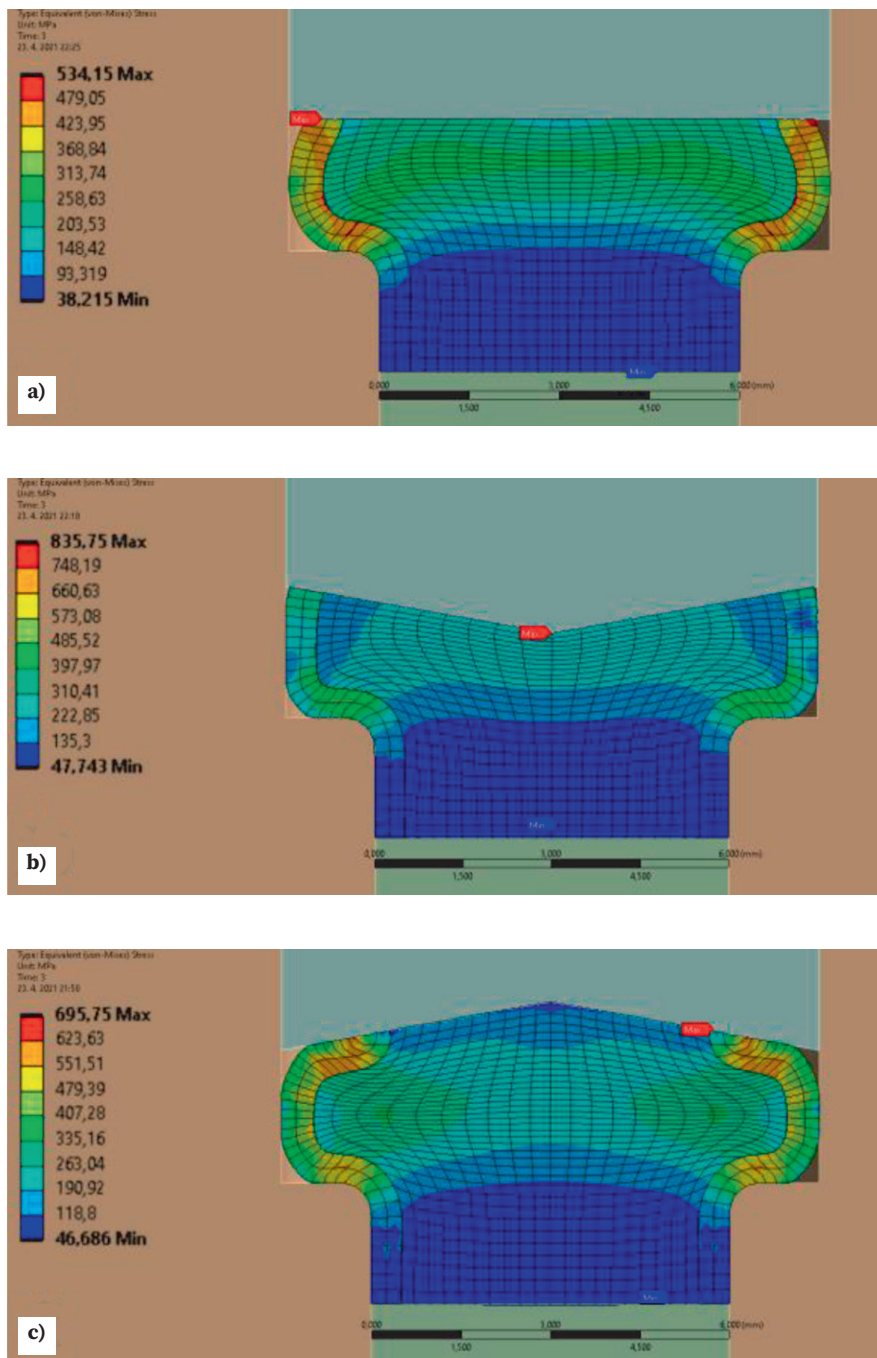

Fig. 10. Distribution of stresses for bimetallic element with flat (a), convex (b) and concave (c) head

Rys. 10. Rozkład naprężeń dla elementu bimetalicznego z głowicą płaską (a), wklęsłą (b) i wypukłą (c)

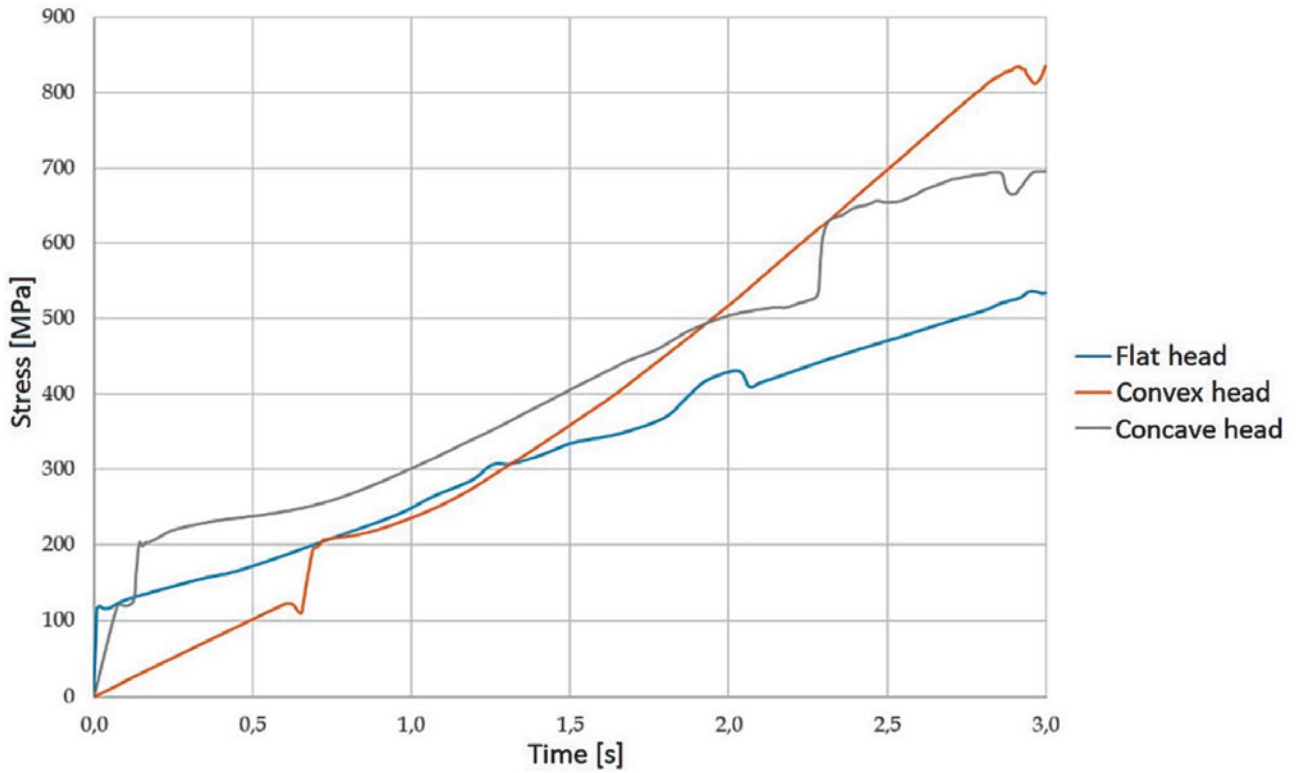

Fig. 11. The course of stresses in the forming process for individual alternatives
 Rys. 11. Przebieg naprężeń w procesie formowania dla poszczególnych wariantów

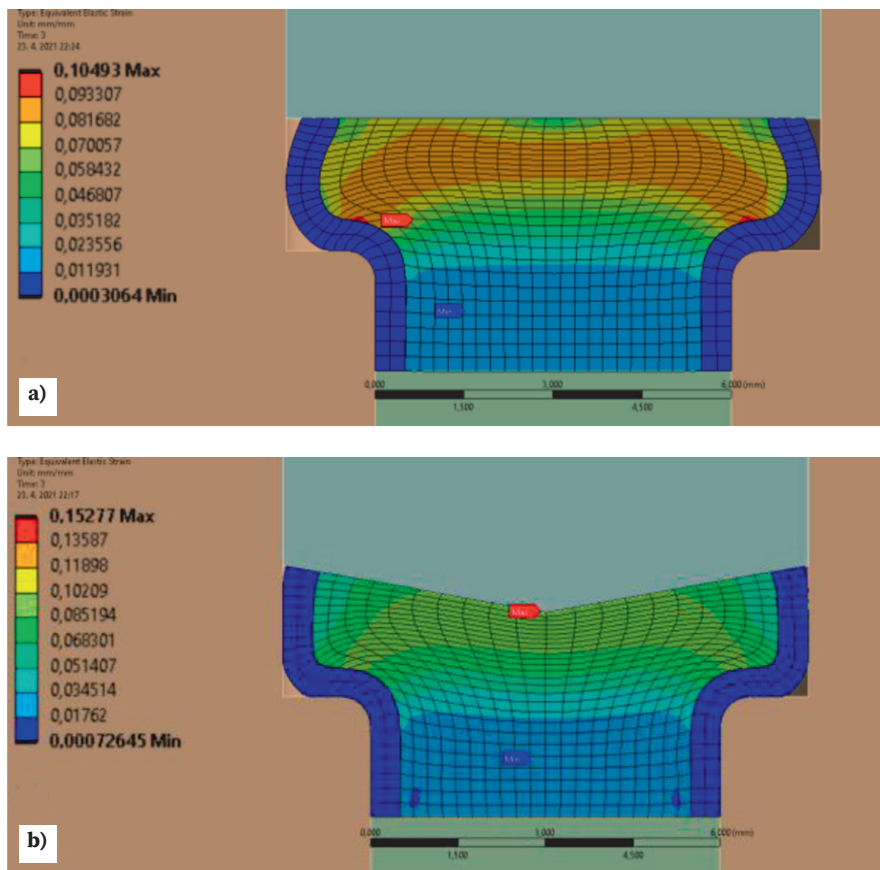

Fig. 12. Distribution of local strains for bimetallic element with flat (a), convex (b) head
 Rys. 12. Rozkład odkształceń lokalnych dla elementu bimetalicznego z głowicą płaską (a), wklęsłą (b)

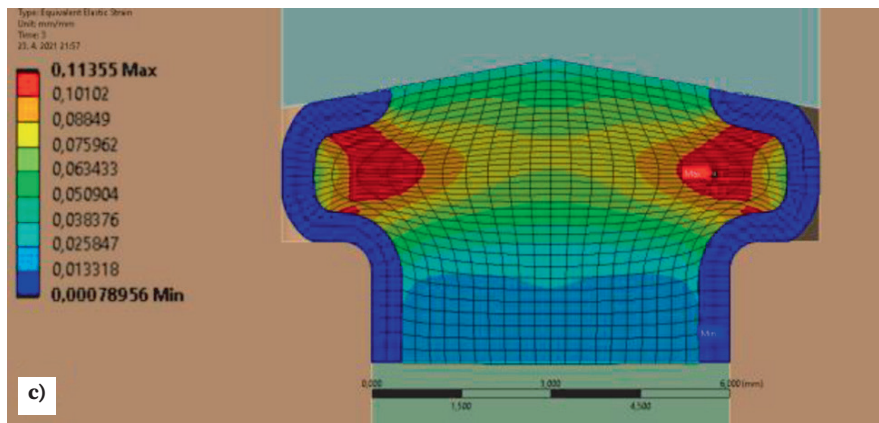

Fig. 12 cont. Distribution of local strains for bimetallic element with concave (c) head
Rys. 12 cd. Rozkład odkształceń lokalnych dla elementu bimetalicznego z głowicą wypukłą (c)

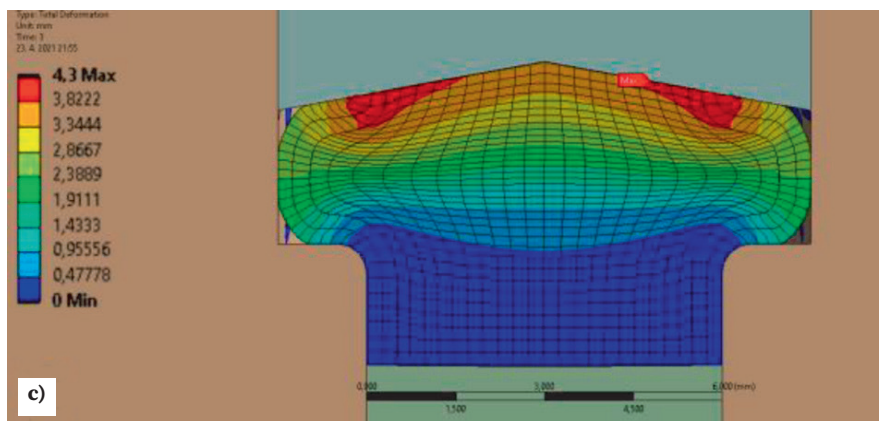
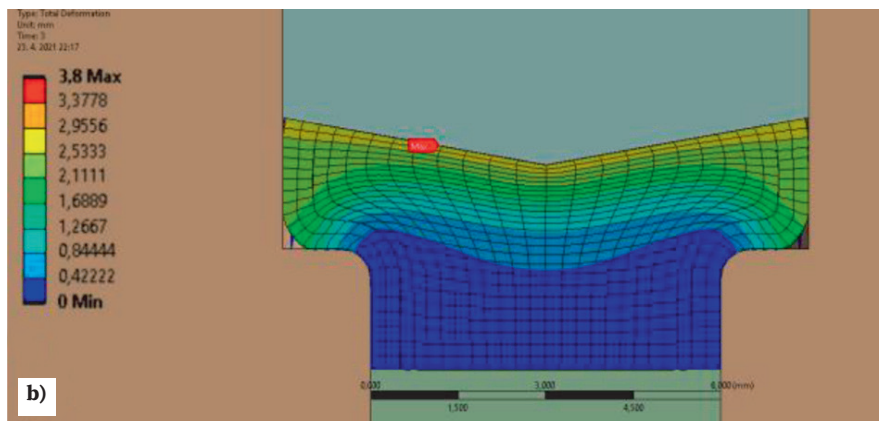
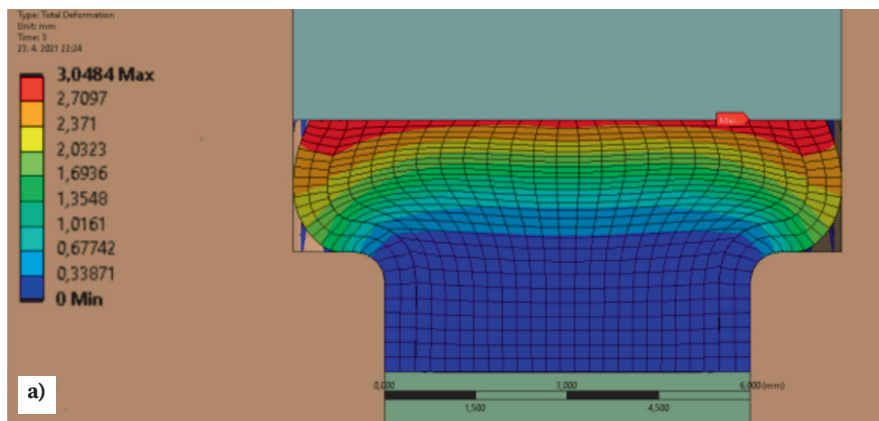

Fig. 13. Distribution of total strains for bimetallic element with flat (a), convex (b) and concave (c) head
Rys. 13. Rozkład odkształceń całkowitych dla elementu bimetalicznego z głowicą płaską (a), wklęsłą (b) i wypukłą (c)

5. EXPERIMENTS

The bimetallic elements were formed on a tool with replaceable punches shaping different types of element heads on the DP1600 hydraulic press at a maximum forming force of 31 kN. The tool in the disassembled state is shown in Fig. 14.

The pressing speed was about $2.7 \text{ mm}\cdot\text{s}^{-1}$. Molyslip MWF lubricant designed for forming operations that creates a protective coating of molysulfide MoS was used. The individual shapes of the extrusions produced by the forward extrusion in a closed die, compared with the output of the simulation, are shown in Figs. 15-17. The shell material did not completely

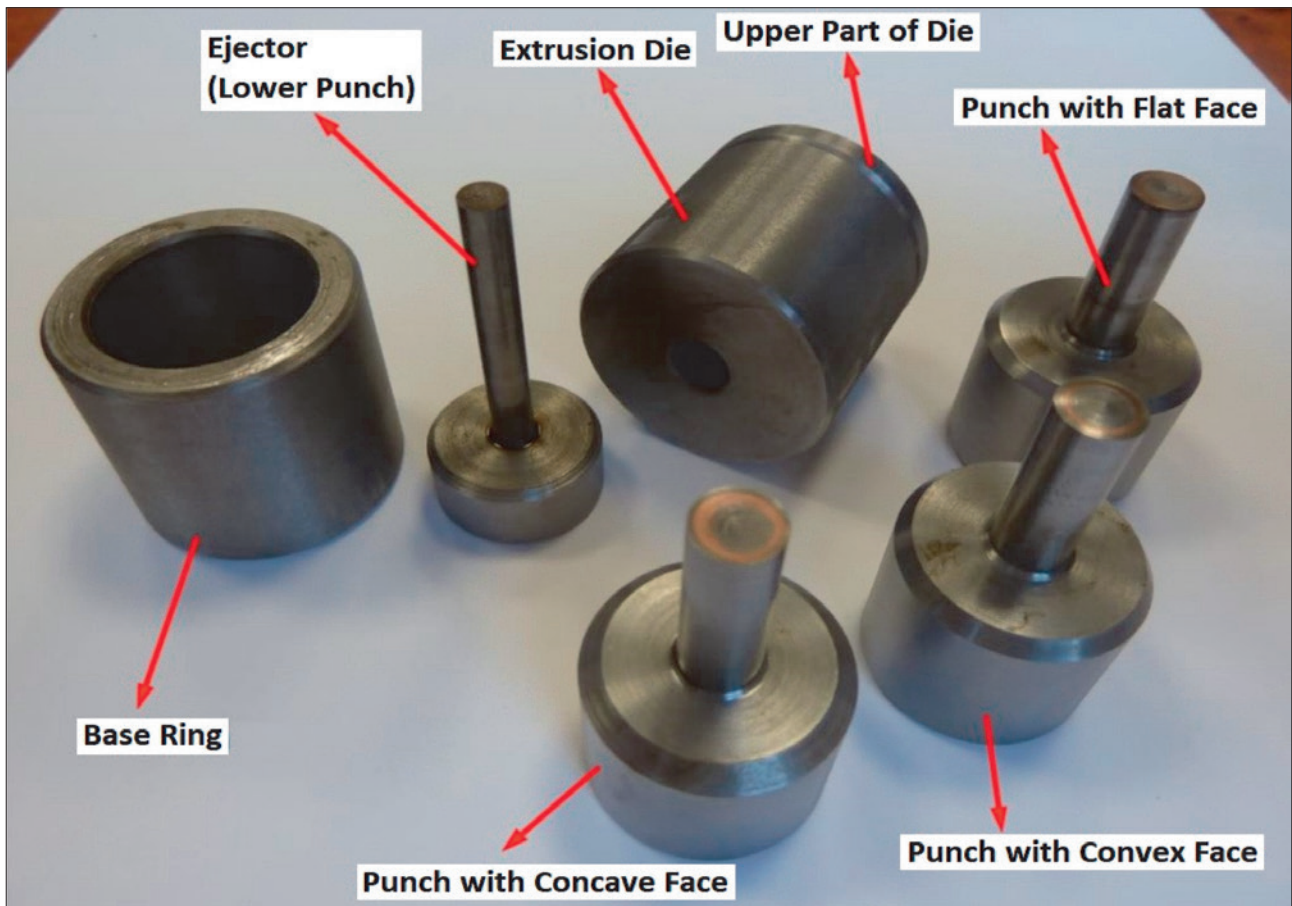

Fig. 14. Functional parts of a laboratory tool with different punches for the manufacturing of elements
Rys. 14. Funkcjonalne części narzędzia laboratoryjnego z różnymi stemplami do produkcji elementów

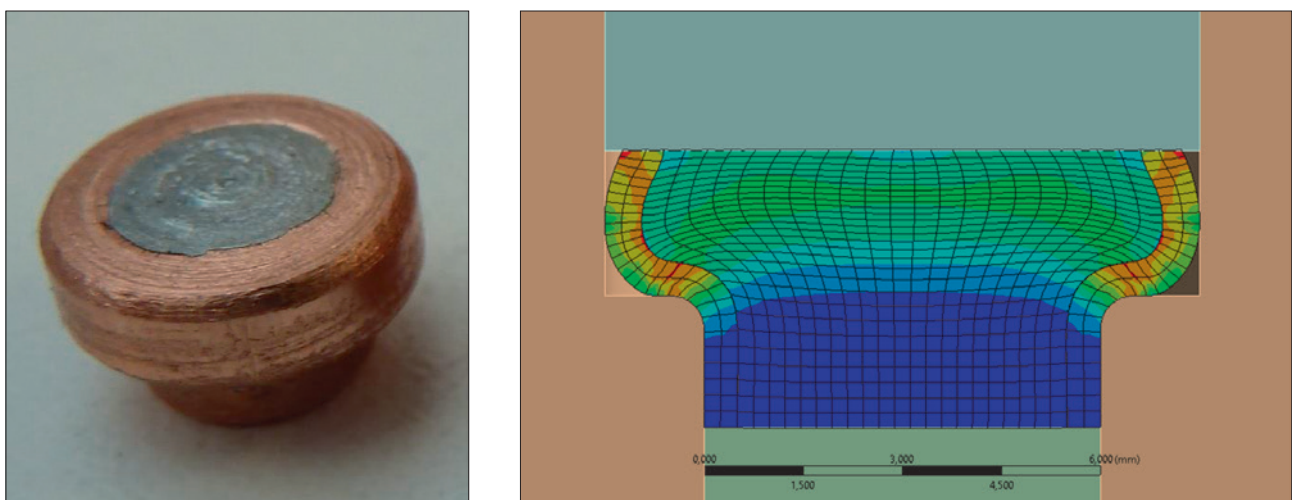

Fig. 15. Comparison of flat head element with the simulation of die cavity filling
Rys. 15. Porównanie elementu z płaską głowicą z symulacją wypełniania wnęki matrycy

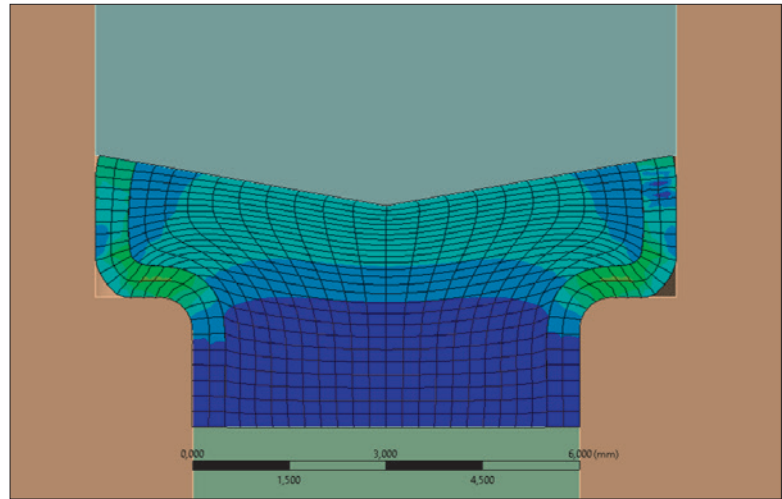

Fig. 16. Comparison of convex head element with the simulation of die cavity filling

Rys. 16. Porównanie elementu z wklęsłą głowicą z symulacją wypełniania wnęki matrycy

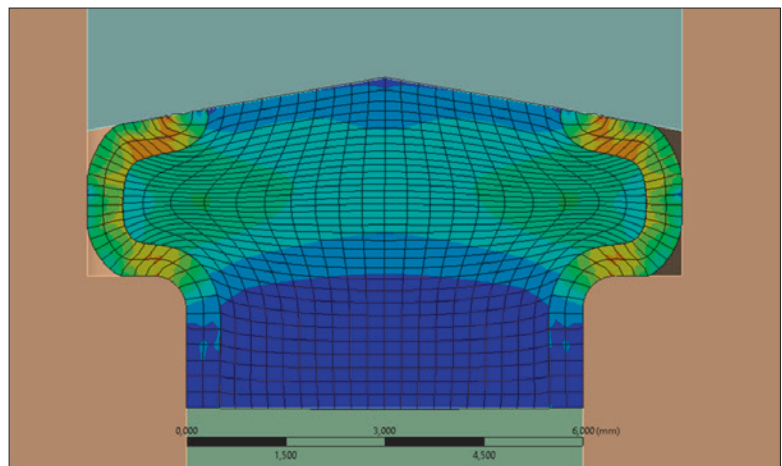

Fig. 17. Comparison of concave head element with the simulation of die cavity filling

Rys. 17. Porównanie elementu z wypukłą głowicą z symulacją wypełniania wnęki matrycy

fill the corners of the die cavity. The reason for not filling the corners with the material was the limiting value of the pressing force. Slight differences are due to the unequal height of the semi-finished product, which also affects the height of the element head.

Macroscopic analysis of the element cross-sections was focused on the strain of the shell, the formation of wrinkles and symmetry. Cross-sections of the elements are in the Fig. 18. No major defects in the form of wrinkles and corrugations are visible. The elements have a symmetrical shape. There are not even significant defects in the form of inclusions, blowholes, and shrinkage cavities in the solder. In the cross-section details (Figs. 19-21), it is possible to observe the dendritic structure of the solder with a texture formed at the location of greatest strain in the heads of the elements.

6. CONCLUSION

When creating overlap joints of materials with significantly different melting temperature (or thermal decomposition temperature), as for example galvanized steel sheet with thermoplastic, is the Resistance Element Soldering (RES) suitable method. The joint is created using a joining element not by welding, but by soldering (with low thermal influence of the base material). The experiments showed the need to solve a special bimetallic element, which was made of a semi-finished product consisting of a thin-walled Cu tube filled with Sn60Pb40 solder. This eliminated the problem of splashing the material of the element, which worsens the functional and aesthetic properties of the joint.

In the production of bimetallic elements, the aim was to create a product with a minimum of defects in the form of eccentricity and wrinkles of the Cu tube shell, which negatively affect the soldering process.

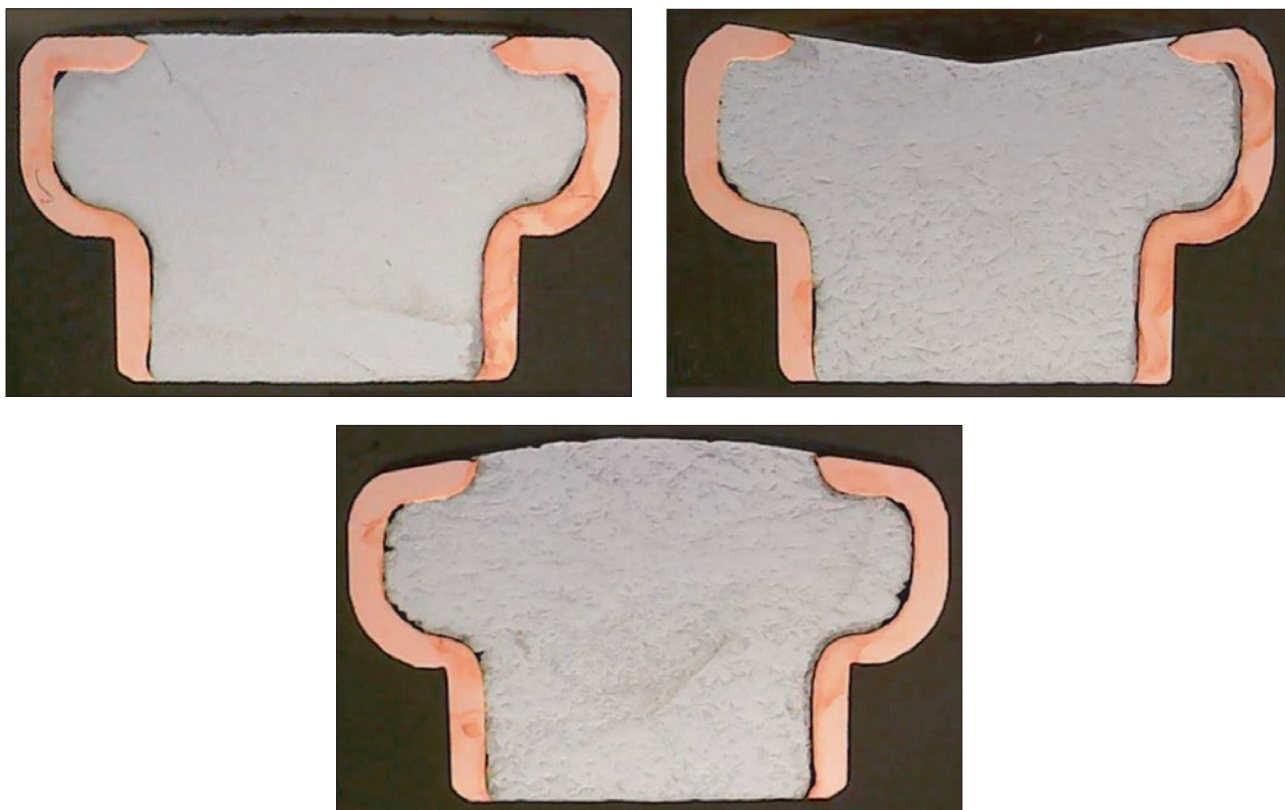

Fig. 18. Element cross-sections with flat (a), convex (b) and concave (c) head

Rys. 18. Przekrój poprzeczny elementu z głowicą płaską (a), wklęsłą (b) i wypukłą (c)

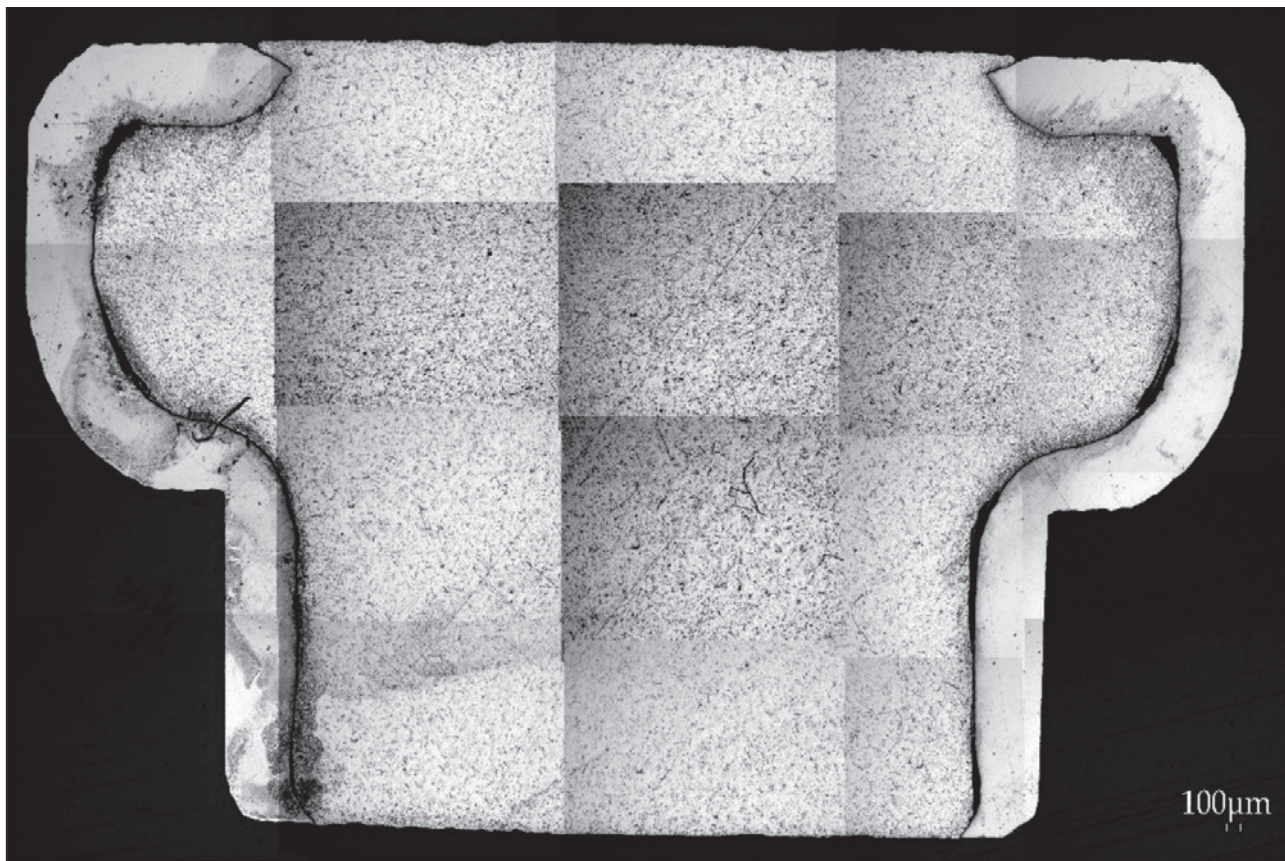

Fig. 19. Cross-section detail of a flathead element

Rys. 19. Przekrój poprzeczny elementu z płaską głowicą

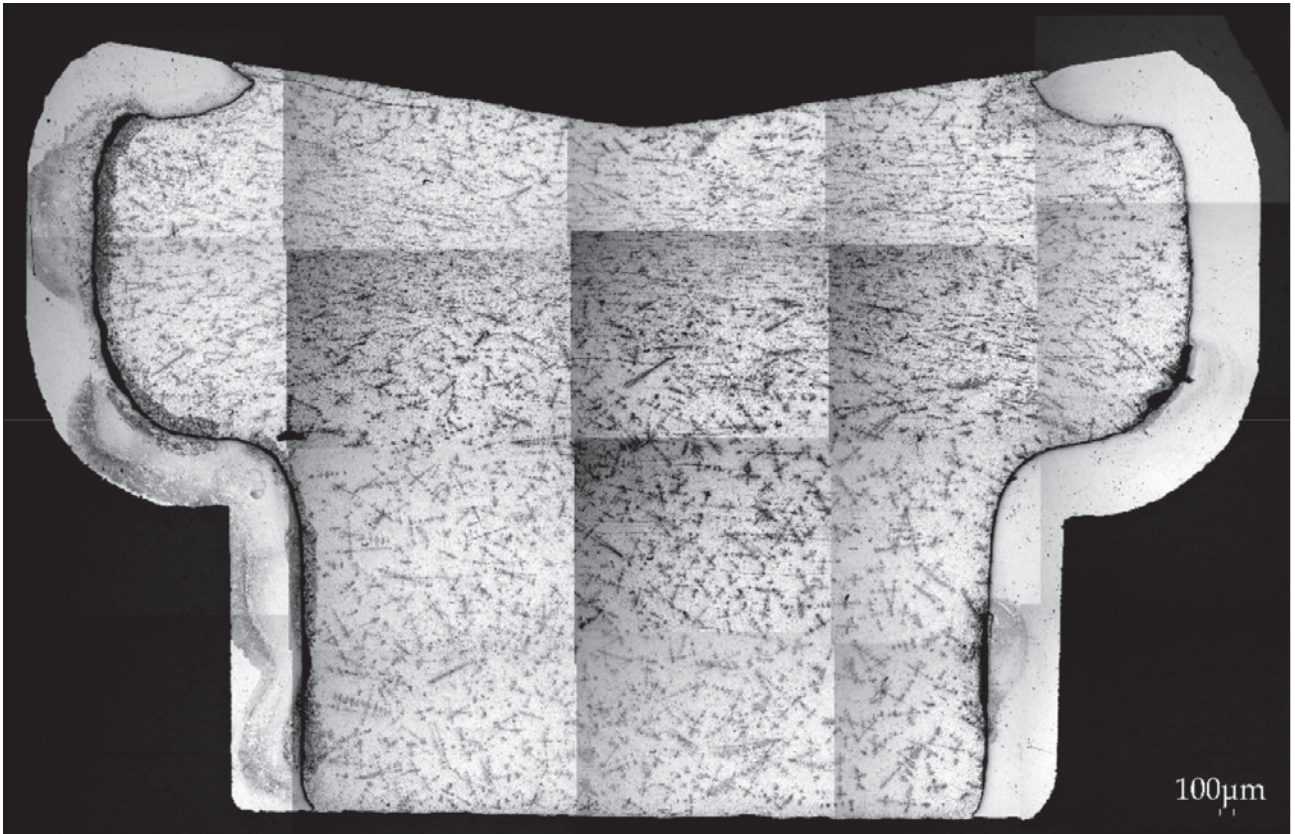

Fig. 20. Cross-section detail of a convex head element
Rys. 20. Przekrój poprzeczny elementu z wklęsłą głowicą

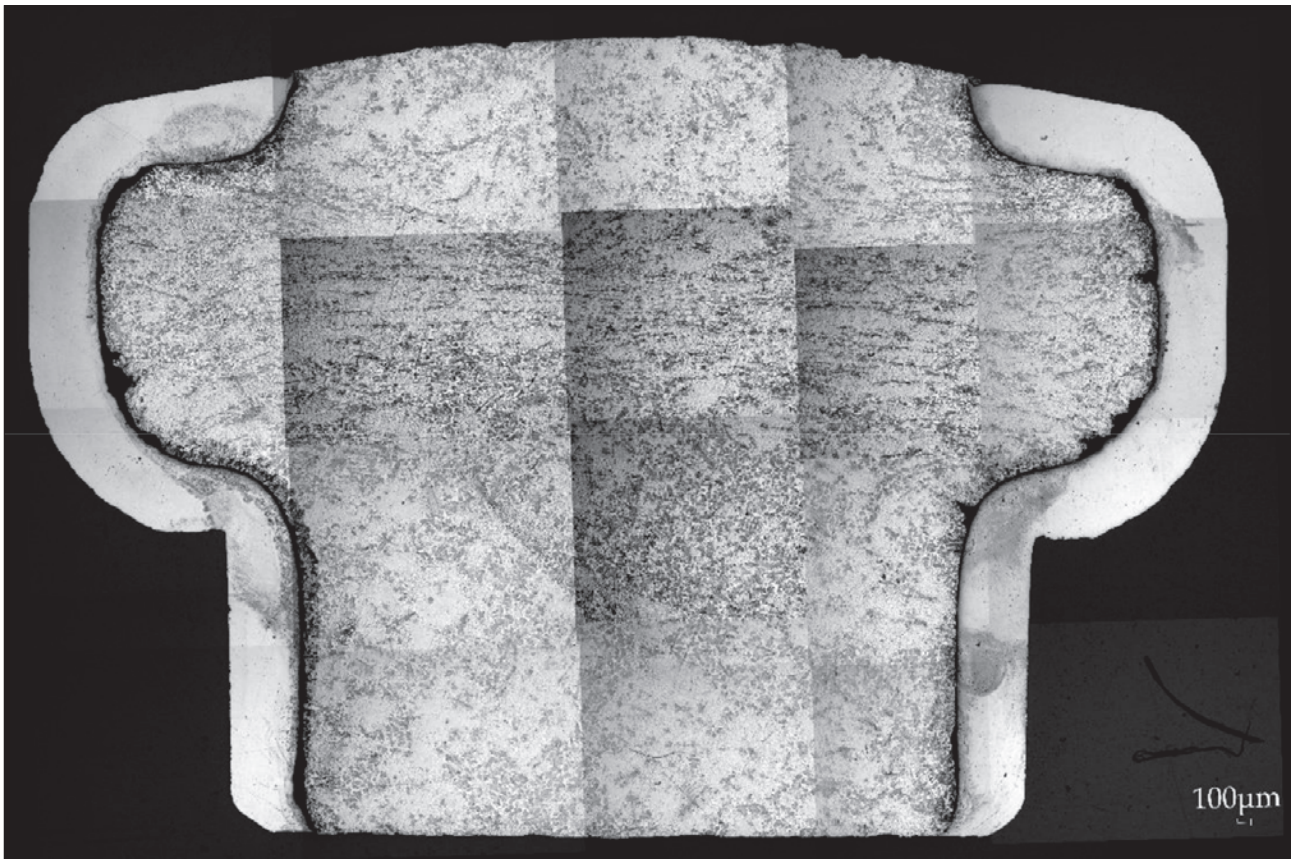

Fig. 21. Cross-section detail of a concave head element
Rys. 21. Przekrój poprzeczny elementu z wypukłą głowicą

Several cold forming methods can be used to form the head of the element. A one-operation technological procedure was chosen and verified by simulation, eliminating the problem with the buckling stiffness of the “free” part of the semi-finished product causing the formation of unwanted wrinkles and eccentricity. The stress-strain parameters of bimetal materials determined by mechanical tests were used for simulation in ANSYS R18.2 software. The simulation included a tool model with different geometry of the part forming the head of the element. The obtained results of simulation and experiments confirmed the correctness of the technological process design. The shape of the face part of the punches did not have a significant effect on the quality of the strain of the element shell. All three shape alternatives were satisfactory. Macroscopic analysis confirmed the absence of any defects in the form of corrugations and wrinkles. The elements have a symmetrical shape. Also, there are no significant defects in the form of inclusions and blowholes in the solder.

It can be assumed that the convex shape of the head will be the most advantageous in terms of joint formation. The face of the electrode during soldering makes primary contact with the Cu shell of the bimetallic element. This minimizes the risk of solder splashing.

This manufacturing process will be used in a production combined process tool, served to divide the semi-finished product to the required length and to form an element. The proposed and verified method of production of bimetallic elements will be used for other dimensions of products.

Acknowledgements

This work was supported by the Slovak Research and Development Agency under the contract No. APVV-16-0485 and University Science Park STU Bratislava ITMS code 26240220084. We would like to thank the Slovak grant agency VEGA for the financial support of the project VEGA 1/0405/19.

REFERENCES

- [1] H. Zhang, J. Senkara. *Resistance welding: fundamentals and applications*, II edition. CRC Press., 2011. ISBN-13: 978-1-43985-371-9.
- [2] K. Martinsen, S.J. Hu, B.E. Carlson. Joining of dissimilar materials. *CIRP Annals – Manufacturing Technology*, 2015, 64 (2), pp. 679-699. <https://doi.org/10.1016/j.cirp.2015.05.006>.
- [3] A. Habibizadeh, M. Honarpisheh, S. Golabi. Determining Optimum Shear Strength of Friction Stir Spot Welding Parameters of AA1050/C10100 Joints. *Manufacturing Technology*, 2021, 21 (3), pp. 315-329. <https://doi.org/10.21062/mft.2021.046>.
- [4] P. Kazanowski, M.E. Epler, W.Z. Misiolek. Bi-metal rod extrusion – process and product optimization. *Materials Science and Engineering: A*, 2004, 369 (1-2), pp. 170-180.
- [5] A. Khosravifard, R. Ebrahimi. Investigation of parameters affecting interface strength in Al/Cu clad bimetal rod extrusion process. *Materials & Design*, 2010, 31 (1), pp. 493-499.
- [6] H. Haghghat, M.M. Mahdavi. Analysis and FEM simulation of extrusion process of bimetal tubes through rotating conical dies. *Trans. Nonferrous Met. Soc. China*, 2013, 23 (11), pp. 3392-3399.
- [7] S.Z. Qaman, T. Pervez, J.Ch. Chekotu. Die Defects and Die Corrections in Metal Extrusion. *Metals*. 2018. 8 (6), art. No. 380.
- [8] P.F. Zheng, L.C. Chan, T.C. Lee. Numerical analysis of the sheet metal extrusion process. *Finite Elements in Analysis and Design*. 2005, 42 (3), pp. 189-207.
- [9] AnsysConcepts. Fulllibrary. [Online] Available at: <https://fulllibrary.com/Mechanical/ANSYS/Learn-Ansys.html> [Accessed on: 6.04.2021].