

## MODELLING OF DIELECTRIC PROPERTIES OF BiNbO<sub>4</sub>-BASED MICROWAVE CERAMICS

In the present paper results of the studies devoted to computer simulations of dielectric response of electroceramics in a frequency domain as well as analysis of the experimental data are given. As an object of investigations BiNbO<sub>4</sub>-based microwave ceramics was taken. Simulations of the hypothetical impedance response of the ceramic system were performed under assumption of the brick-layer model. A strategy for analysis and modelling of the impedance data for microwave electroceramics was discussed. On the base of the discussed strategy modelling of the dielectric response of BiNbO<sub>4</sub> ceramics was performed with the electric equivalent circuit method. The Voigt's and Maxwell's circuits were taken as electric models. Parameters of the electric components of the circuits were determined and related to parameters of the ceramic object under study. It was found that fitting quality was good and changed within the range  $\chi^2 = 6.78 \times 10^{-4} - 6.77 \times 10^{-5}$  depending on the model.

*Keywords:* BiNbO<sub>4</sub> ceramics, impedance spectroscopy, simulation and modelling, equivalent electric circuit method

### 1. Introduction

Alternating current methods, in particular impedance spectroscopy (IS), play an increasingly important role in researches devoted to the development of new materials and the improvement of those already used in electronics and telecommunications [1]. IS means a measurement of the electrical response of the investigated material subjected to stimulation with a small electromagnetic signal in a broad frequency band and further analysis of this response to reveal useful information on the electrical properties of the tested material [2]. It is an important research method due to its simplicity and clarity in the description of electrical processes occurring in ceramic material under the influence of an alternating signal [3].

Application of impedance spectroscopy in the study of electrical properties of ceramics allows a direct comparison of the behaviour of the real object (ceramics) and its model – an electric equivalent circuit [2,4]. Approximation of impedance of the real object (ceramics) with an electric equivalent model allows us to check correctness of the model by comparing the runs of amplitude-frequency and phase-frequency characteristics of complex impedance, complex admittance, complex dielectric permittivity or complex electric modulus in a specific frequency area.

The dynamic properties of the studied material in the frequency domain are usually described by spectral transmittance, which in IS takes the form of complex impedance ( $Z^*$ ) or complex admittance ( $Y^*$ ). In the IS method, complex electric permittivity ( $\epsilon^*$ ) or complex electric modulus ( $M^*$ ) can also be used. Basic quantities describing the dynamic properties of the measured system in the frequency domain and the relationships between them can be found in the literature [e.g. 5-8].

### 2. Theoretical. Simulation of dielectric response

In order to illustrate the methods of impedance spectra presentation, a hypothetical impedance response of a ceramic system based on a brick-layer model [9,10] of the real structure was simulated. In this model (Fig. 1a) the structure is presented in the form of cubic grains separated by grain boundaries [8]. The equivalent electric model of such a structure consists of two parallel  $RC$  circuits connected in series:  $(R_1C_1)(R_2C_2)$  [4,11]. An additional parallel circuit  $(R_3C_3)$  connected in series with  $(R_1C_1)$   $(R_2C_2)$  was used to account for the contribution to the impedance of the ceramic-electrode interface areas. The ceramic material model and its electric equivalent circuit are shown in Fig. 1a and Fig. 1b, respectively.

<sup>1</sup> GDAŃSK UNIVERSITY OF TECHNOLOGY, FACULTY OF MECHANICAL ENGINEERING, DEPARTMENT OF MATERIALS ENGINEERING AND WELDING, 11/12, NARUTOWICZA STR., GDAŃSK, 80-233, POLAND

<sup>2</sup> PEDAGOGICAL UNIVERSITY OF CRACOW, INSTITUTE OF TECHNOLOGY, 2 PODCHORĄŻYCH STR., 30-084 KRAKÓW, POLAND

\* Corresponding author: dionizy.czekaj@pg.edu.pl

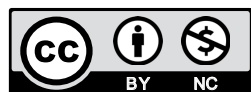

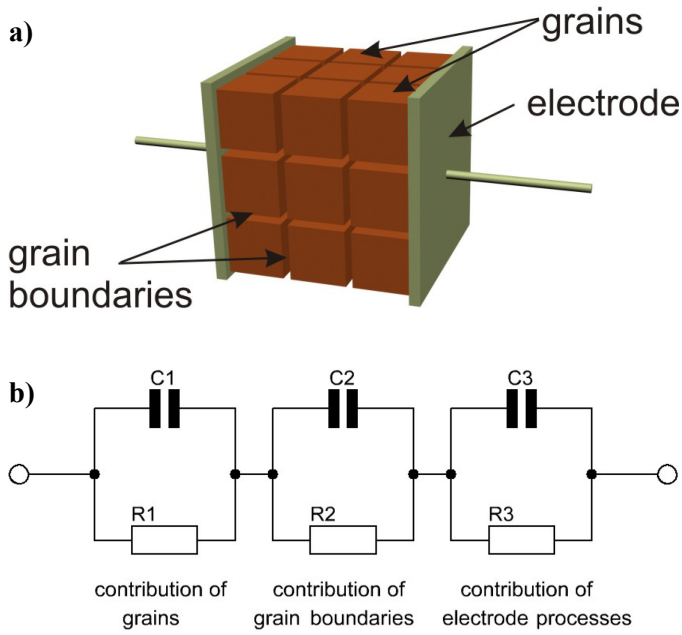

Fig. 1. Brick-layer model of ceramics (a) and corresponding electric equivalent circuit  $(R_1C_1)(R_2C_2)(R_3C_3)$  (b)

In an ideal case, the AC response of individual components of ceramic material to a sinusoidal signal input lies in different frequency ranges [9]. In the case of a large difference between the relaxation frequency ( $\nu_{\max} = \omega_{\max}/2\pi$ ) of electrode ( $\nu_{el}$ ), grain boundary ( $\nu_{gb}$ ) and bulk (i.e. within grains) processes ( $\nu_B$ ), i.e. when the relationship (Eq. (1)):

$$\nu_B \gg \nu_{gb} \gg \nu_{el} \quad (1)$$

is fulfilled [12,13] the impedance spectrum should contain clearly separated contributions of individual components (grains, grain boundaries and interfacial regions) of the ceramic material [14].

From the point of view of impedance spectroscopy, it is important to determine the relaxation time of polarization phenomena ( $\tau = 1/\omega_{\max} = RC$ ). Knowledge of the time constant allows to determine what phenomenon we are dealing with in the material under investigation [9]. Due to different time constants it is possible to separate the contribution of grains, grain boundaries and electrode processes to the dielectric response of the system.

Parameters of the electric equivalent circuit used for the simulation (Fig. 1b) were chosen so that the system was characterized by a large difference in the frequency of relaxation processes occurring inside the grains, at grain boundaries and in the vicinity of electrodes. In order to emphasize the peculiarities of different forms of presentation of the impedance data, two cases were considered: (i) the system is characterized by similar resistivity values but significantly different capacitances of the component areas (Fig. 2), and (ii) the system is characterized by similar capacitance values, but the resistances of the component areas differ significantly in value (Fig. 3, Fig. 4).

The result of the simulation of the hypothetical impedance response of the system  $(R_1C_1)(R_2C_2)(R_3C_3)$  characterized by different time constants of polarization processes (relaxation times) caused by the difference in capacitance components, is

presented in the graphic form on the complex plane  $Z''-Z'$  in Fig. 2. It manifests itself in the form of consecutive semicircles representing electrical phenomena associated with individual material components.

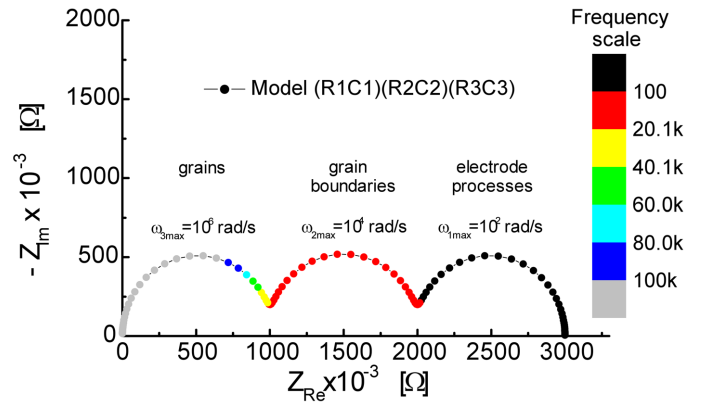

Fig. 2. Calculated impedance response of the system with separated contribution of bulk, grain boundaries and electrode processes. The values of the circular frequency of relaxation processes are shown

Unfortunately, in real oxide systems this behaviour is usually more complicated. The semicircles are distorted and overlapping one another thus making it difficult to identify phenomena originating from individual components of the ceramic material. To support the above mentioned, Fig. 3 presents the hypothetical dielectric response of the system  $(R_1C_1)(R_2C_2)(R_3C_3)$  with the same time constants as in Fig. 2, but with similar values of the capacitance of the component areas. One can see in Fig. 3 that the semicircles related to the grain boundary and bulk relaxation processes were "hidden" at the beginning of the  $Z''-Z'$  complex coordinate system.

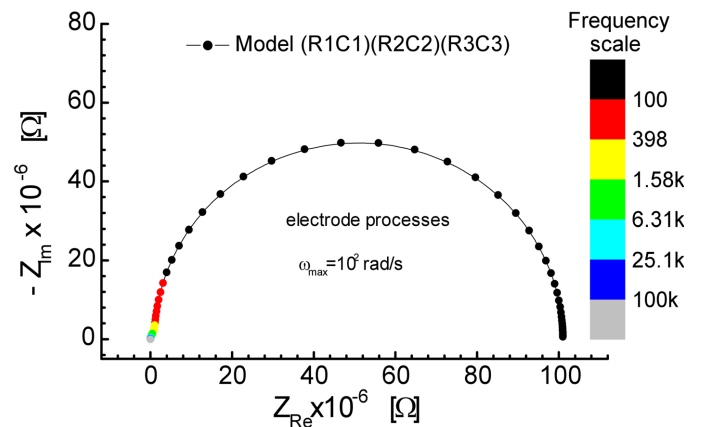

Fig. 3. Theoretical impedance response of a circuit  $(R_1C_1)(R_2C_2)(R_3C_3)$  exhibiting similar capacitive components and different resistance components plotted on a complex  $Z''-Z'$  plane

Therefore, it is advisable to use alternative methods of presenting impedance measurement data [4,7,8,12-15]. Usually they are very useful not only to identify individual processes [16,17] but also to determine the initial parameters of matching experimental data to the responses of the mathematical model [4,18].

To confirm the above mentioned, the dielectric response of the system exhibiting similar capacitive components (Fig. 3) is shown in the electric modulus plane  $M''$ - $M'$ . One can see in Fig. 4 that the semicircles are clearly separated so the contribution of bulk, grain boundary and electrode processes can be distinguished.

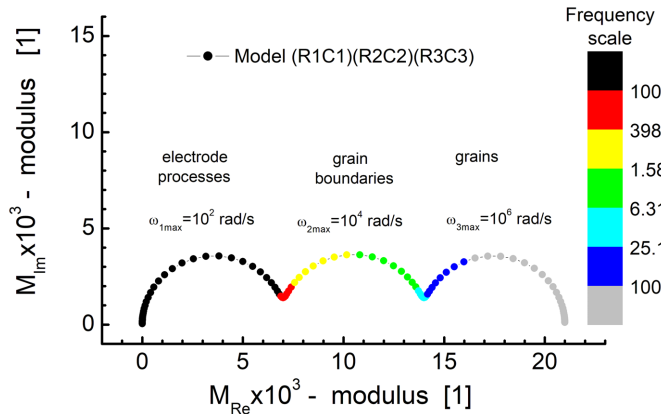

Fig. 4. Simulation of an impedance response for a circuit  $(R_1C_1)(R_2C_2)(R_3C_3)$  exhibiting similar capacitive components plotted on a complex  $M''$ - $M'$  plane

### 3. Experiment

$\text{BiNbO}_4$ -based microwave ceramics was used as the material of investigations.  $\text{BiNbO}_4$  ceramics was fabricated by pressureless sintering. A detailed description of the technological process used and the influence of technological parameters on the crystal structure, phase composition, microstructure and chemical composition of  $\text{BiNbO}_4$ -based ceramics are provided in our previous works [e.g. 19,20]. Alpha-A High Performance Frequency Analyzer system was used for performing the measurements in the frequency range from  $\nu = 10$  Hz to  $\nu = 1$  MHz.

Computer programmes by B. Boukamp were used to simulate and fit experimental data to the responses of the mathematical model [21,22]. CNLS (*complex non-linear least squares method*) method was used for data fitting [18,22].

The quality of the fitting procedure was assessed numerically by calculating the parameters:  $\chi$ -square ( $\chi^2$ ) and weighted sum of squares (WSS), and graphically by preparing spectroscopic difference charts (so-called FQ-fit quality plots) as described by us in [7].

### 4. Results and discussion

Analysis of the obtained experimental results was carried out by comparing the behaviour of the real object ( $\text{BiNbO}_4$ -based ceramics) and its electric equivalent circuit (i.e. model) in a specific frequency region. Electric equivalent circuit is a model that always refers to the actual impedance of the real object. Approximation of the physical object impedance with an equivalent

model allows us to check the correctness of the model used. There is always a danger, however, that the assumed model does not reflect reality. This is due to the fact that the measured characteristics can often be described by various complex equivalent circuits [4, 23,24].

It is worth to note that Voigt  $[(R_1C_1)(R_2C_2)]$  and Maxwell  $(R_1C_1[R_2C_2])$  circuits, shown in Fig. 5a and Fig. 5b respectively, exhibit identical impedance characteristics and they are experimentally indistinguishable [4,24].

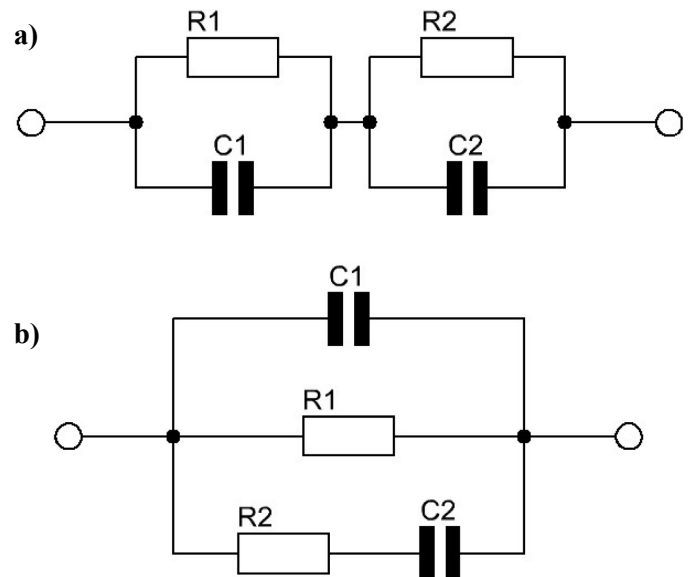

Fig. 5. The electrical equivalent circuits of the same impedance: (a) the Voigt's circuit,  $[(R_1C_1)(R_2C_2)]$ ; (b) the Maxwell's circuit  $(R_1C_1[R_2C_2])$

Real systems of ceramic materials are rarely described as a simple  $RC$  circuits [8,9]. For this reason, in order to describe more accurately the processes occurring at the grain boundaries or inside the grains, the circuits shown in Fig. 5 were modified by using constant phase elements, CPE [24]. Results of the analysis using the Voigt model described as  $[(R_1CPE_1)(R_2CPE_2)]$  are shown in Fig. 6 and Fig. 7. Parameters of the equivalent electrical circuit are shown in Table 1.

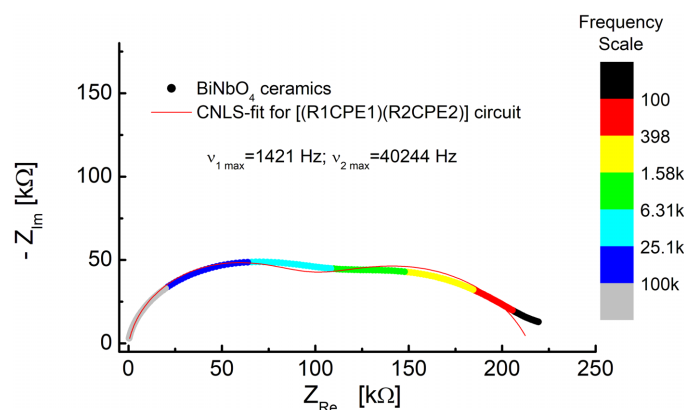

Fig. 6. Impedance data plotted in a complex  $Z''$ - $Z'$  plane (circles) and CNLS fit (line) calculated according to a Voigt's equivalent circuit  $[(R_1CPE_1)(R_2CPE_2)]$

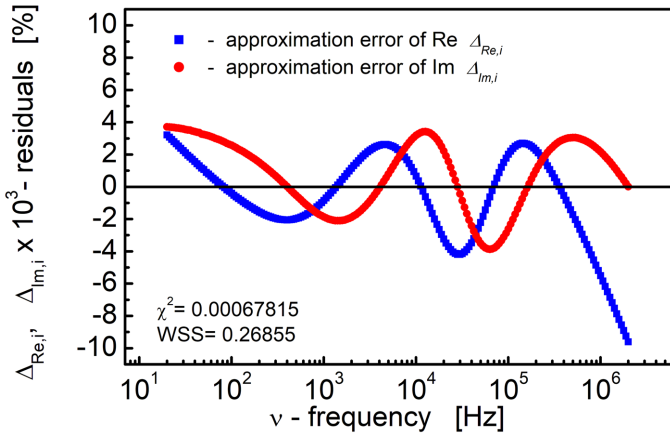

Fig. 7. Fit-quality plot for CNLS-fit of experimental impedance data and Voigt's model

TABLE 1

Parameters of the Voigt electric equivalent circuit fitted to the impedance response of BiNbO<sub>4</sub> ceramic

Parameter	Value	Approximation Error	Relative Error [%]
$R_1$ [Ω]	$1.2554 \times 10^5$	3443,5	2.743
$CPE_1 - T$ [1/Ω]	$8.8562 \times 10^{-9}$	$9.0607 \times 10^{-10}$	10.231
$CPE_1 - P$ [a.u.]	0.74769	0.015803	2.1136
$R_2$ [Ω]	88944	2756.1	3.0987
$CPE_2 - T$ [1/Ω]	$1.3197 \times 10^{-10}$	$9.2081 \times 10^{-12}$	6.9774
$CPE_2 - P$ [a.u.]	0.91255	0.0062898	0.68926
WSS	0.26855		
$\chi^2$	$6.7815 \times 10^{-4}$		

Results of the analysis using the Maxwell model described as ( $R_1 CPE_1 [R_2 CPE_2]$ ) are shown in Fig. 8 and Fig. 9. Parameters of the equivalent electrical circuit are shown in Table 2.

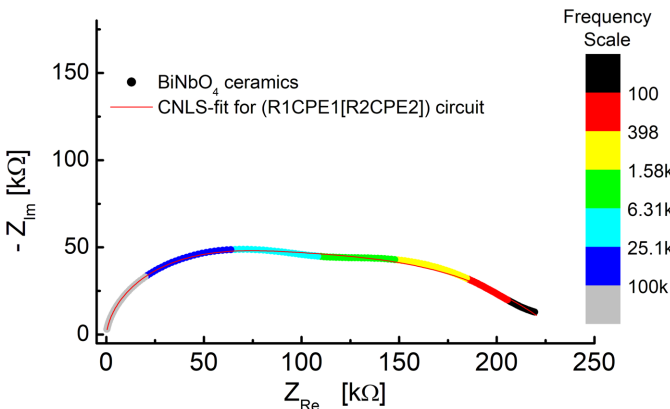

Fig. 8. Impedance data plotted in a complex  $Z''$ - $Z'$  plane (circles) and CNLS fit (line) calculated according to a Maxwell's equivalent circuit ( $R_1 CPE_1 [R_2 CPE_2]$ )

After analyzing the experimental data using the Voigt model (Table 1), it was found that BiNbO<sub>4</sub> ceramics show the presence of two relaxation processes characterized by frequencies  $\nu_1 = 1421$  Hz and  $\nu_2 = 40244$  Hz. Considering the fact that capacitance related to CPE elements are  $C_1 = 890$  pF and

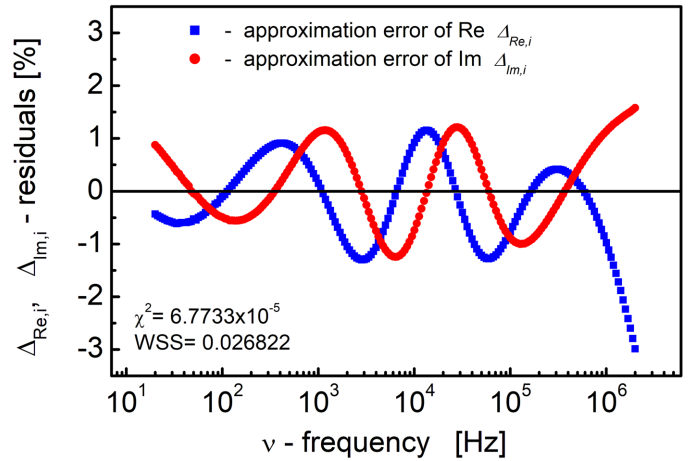

Fig. 9. FQ-plot for CNLS-fit of experimental impedance data and Maxwell electric equivalent circuit

TABLE 2

Parameters of the Maxwell electric equivalent circuit fitted to the impedance response of BiNbO<sub>4</sub> ceramic

Parameter	Value	Approximation Error	Relative Error [%]
$R_1$ [Ω]	$2.3283 \times 10^5$	671.83	0.28855
$CPE_1 - T$ [1/Ω]	$8.1285 \times 10^{-11}$	$1.4905 \times 10^{-12}$	1.8337
$CPE_1 - P$ [a.u.]	0.93174	0.0011745	0.12605
$R_2$ [Ω]	$1.0749 \times 10^5$	2314.5	2.1532
$CPE_2 - T$ [1/Ω]	$2.9718 \times 10^{-8}$	$1.3669 \times 10^{-9}$	4.5996
$CPE_2 - P$ [a.u.]	0.49535	0.0047461	0.95813
WSS	0.026822		
$\chi^2$	$6.7733 \times 10^{-5}$		

$C_2 = 44$  pF, it can be assumed [8,4,16] that the process described by  $R_1$ ,  $C_1$  and  $\nu_1$  parameters occurs at grain boundaries, while the process characterized by  $R_2$  values,  $C_2$  and  $\nu_2$  is a process that takes place inside the bulk material.

Comparing the results obtained in the process of impedance data analysis, it can be seen that both models show high compliance with experimental data. The visual assessment of the quality of the Maxwell model fit to the experimental data (Fig. 8 and Fig. 9) indicates a more accurate fit especially in those measuring frequency ranges for which the Voigt model gave some deviations. The numerical assessment of the fit quality (Table 2) confirms that the Maxwell model used to analyze the impedance data of BiNbO<sub>4</sub> ceramics is more accurate than the Voigt model.

## 5. Conclusions

In this paper, a strategy for testing ceramics using impedance spectroscopy and a methodology for analyzing obtained results based on the application of the method of electrical equivalent circuits has been developed and presented. The use of equivalent circuits known as the Voigt model and the Maxwell model to analyze the dynamic dielectric properties

of BiNbO<sub>4</sub>-based ceramics has shown that the material under studies shows at least two relaxation processes occurring in the low and high frequency region. Processes have been attributed to relaxation phenomena occurring at the grain boundaries and inside the grains.

#### Acknowledgement

The present research has been supported by Polish National Science Centre (NCN) as a research project N N507 218540.

#### REFERENCES

- [1] E. Barsukov, J. Ross Macdonald J., (Red)., Impedance spectroscopy, theory, experiment, and applications, John Willey & Sons, Inc., Hoboken, New Jersey, 2005,
- [2] K. Nitsch, Zastosowanie spektroskopii impedancyjnej w badaniach materiałów elektronicznych, Oficyna Wydawnicza Politechniki Wrocławskiej, Wrocław 1999.
- [3] W. Bogusz, F. Krok, Elektrolity stałe. Właściwości elektryczne i sposoby ich pomiaru, WNT Warszawa, 1995.
- [4] E.J. Abram, D.C. Sinclair, A.R. West, A strategy for analysis and modelling of impedance spectroscopy data of electroceramics: Doped lanthanum gallate, *Journal of Electroceramics* **10**, 165-177 (2003).
- [5] D.K. Pradhan, B.K. Samantaray, R.N.P. Choudry, A.K. Thakur, Complex impedance studies on a layered perovskite ceramic oxide – NaNdTiO<sub>4</sub>, *Mater. Sci. Eng. B* **116**, 7-13 (2005).
- [6] A. Lisińska-Czekaj, E. Jartych, M. Mazurek, J. Dzik, D. Czekaj, Dielektryczne i magnetyczne właściwości ceramiki multiferroicznej Bi<sub>5</sub>Ti<sub>3</sub>FeO<sub>15</sub>, *Materiały Ceramiczne / Ceramic Materials* **62**, 2, 126-133(2010).
- [7] D. Czekaj, A. Lisińska-Czekaj, T. Orkisz, J. Orkisz, G. Smalarz, Impedance spectroscopic studies of sol-gel derived barium strontium titanate thin films, *Journal of the European Ceramic Society* **30**, 465-470 (2010) .
- [8] A. Lisińska-Czekaj, Wielofunkcyjne materiały na podstawie tytanian bizmutu, Uniwersytet Śląski, Wydawnictwo Gnome, Katowice 2012.
- [9] M. Nocuń, Wprowadzenie do spektroskopii impedancyjnej w badaniach materiałów ceramicznych, Wyd. Nauk. Akapit, Kraków 2003.
- [10] R. Waser, Modeling of electroceramics – application and prospects, *Journal of the European Ceramic Society* **19**, 655-664 (1999).
- [11] J. Fleig, J. Maier, The impedance of ceramics with highly resistive grain boundaries: Validity and limits of the brick layer model, *Journal of the European Ceramic Society* **19**, 693-696 (1999).
- [12] J.C.C. Abrantes, J.A. Labrincha, J.R. Frade, Representations of impedance spectra of ceramics. Part I. Simulated study cases, *Materials Research Bulletin* **35**, 955-964 (2000).
- [13] J.C.C. Abrantes, J.A. Labrincha, J.R. Frade, Representations of impedance spectra of ceramics. Part II. Spectra of polycrystalline SrTiO<sub>3</sub>, *Materials Research Bulletin* **35**, 965-976 (2000).
- [14] J.E Bauerle, Study of solid electrolyte polarization by a complex admittance method, *J Phys Chem Solids* **30**, 12, 2657-2670 (1969).
- [15] D.C. Sinclair, A.R. West, Effect of atmosphere on the PTCR properties of BaTiO<sub>3</sub> ceramics, *J. Mater. Sci.* **29**, 23, 6661-6668 (1994).
- [16] J.C. Ruiz-Morales, D. Marrero-Lopez, J.T.S. Irvine, P. Nunez, A new alternative representation of impedance data using the derivative of the tangent of the phase angle. Application to the YSZ system and composites, *Materials Research Bulletin* **39**, 1299-1318 (2004).
- [17] J.C. Ruiz-Morales, D. Marrero-Lopez, J. Canales-Vazquez, P. Nunez, J.T.S. Irvine, Application of an alternative representation to identify models to fit impedance spectra, *Solid State Ionics* **176**, 2011-2022 (2005) .
- [18] B. Boukamp, A nonlinear least squares fit procedure for analysis of immittance data of electrochemical systems, *Solid State Ionics* **20**, 31-44 (1986).
- [19] D. Czekaj, A. Lisińska-Czekaj, Influence of phase composition on dielectric properties of bismuth-based ceramics with scheelite-type structure, *Key Engineering Materials* 602-603, 683-688 (2014).
- [20] A. Lisińska-Czekaj, D. Czekaj, J. Plewa, Influence of processing conditions on crystal structure of BiNbO<sub>4</sub> ceramics, *Ciencia & Tecnologia dos Materiais* **29**, e215-e218 (2017).
- [21] B.A. Boukamp, A Linear Kronig-Kramers Transform Test for Immittance Data Validation, *J. Electrochem. Soc.* **142** (6), 1885-1894 (1995).
- [22] B.A. Boukamp, Electrochemical Impedance Spectroscopy in Solid State Ionics; Recent Advances, *Solid State Ionics* **169** (1-4), 65-73 (2004).
- [23] A.R. West, D.C. Sinclair, N. Hirose, Characterization of electrical materials, especially ferroelectrics, by impedance spectroscopy, *Journal of Electroceramics* **1**, 65-71(1997).
- [24] A. Lasia, Electrochemical impedance spectroscopy and its applications. In: B.E. Conway, J.O'.M. Bockris, R.E. White (Eds.), *Modern Aspects of Electrochemistry*, 32, Kluwer Academic/Plenum Publishers, 143-248, New York (1999).