

DEVELOPMENT AND MODELING OF THE ANTENNA SYSTEM THE DIRECTION FINDER UNMANNED AERIAL VEHICLE

Juliy Boiko¹, Oleksiy Polikarovskiy², Vitalii Tkachuk³

¹Khmelnytskyi National University, Department of Telecommunications, Media and Intelligent Technologies, Khmelnytskyi, Ukraine, ²Odessa National Maritime University, Department of Technical Cybernetics and Information Technologies, Odessa, Ukraine, ³Khmelnytskyi National University, Department of Mechanical Engineering Technology, Khmelnytskyi, Ukraine

Abstract. The article is devoted to the design the proposed construction of the antenna system for the direction-finding complex of the unmanned aerial vehicle (UAV). The experimental part is represented by the results of mathematical modeling the behavior of the antenna in different parts the operating frequency range. The effectiveness of the adopted design solutions was evaluated in comparison with analogues of leading companies in the world. Based on the results of the research, the areas of application the antenna as part of the built-in functional mobile UAV direction finding systems were determined.

Keywords: antennas, radiation pattern, modeling, voltage control

OPRACOWANIE I MODELOWANIE SYSTEMU ANTENOWEGO CELOWNIKA BEZZAŁOGOWEGO STATKU POWIETRZNEGO

Streszczenie. Artykuł poświęcony jest zaprojektowaniu proponowanej konstrukcji systemu antenowego dla zespołu radionawigacyjnego bezzałogowego statku powietrznego (BSP). Część eksperymentalna jest reprezentowana przez wyniki matematycznego modelowania zachowania anteny w różnych częściach zakresu częstotliwości pracy. Skuteczność przyjętych rozwiązań konstrukcyjnych została oceniona w porównaniu z odpowiednikami wiodących firm na świecie. Na podstawie wyników przeprowadzonych badań określono obszary zastosowania anteny w ramach wbudowanych funkcjonalnych mobilnych systemów radionamierzenia bezzałogowych statków powietrznych.

Słowa kluczowe: anteny, charakterystyka promieniowania, modelowanie, sterowanie napięciem

Introduction

Direction finding and positioning the location of the source of radio emission (RES) is an important task in the implementation of the introduction of measures for radio monitoring, solved in the interests of civil and special services, including during antiterrorist and military operations.

For a direction finder, the efficiency of solving the problem of radio monitoring depends on characteristics such as the accuracy of the measurement of the angle of arrival radio waves, the type of polarization of the direction-finding signals, the spatial resolution breaking capacity, sensitivity and operating frequency range. Specified the characteristics of the radio direction finder are largely determined by the parameters of the antenna system used. Therefore, research and development radio direction finders for small UAVs [4, 9, 13] is a very relevant scientific practical task for: increasing the accuracy of measuring the angular coordinates of RES; increasing resolution in angular coordinates; increasing the sensitivity of the receiving antenna system; reducing the weight and size parameters of the equipment.

When designing radio direction finders [3, 5], satisfy-meeting the above requirements, an important task is the development of antenna systems and methods for processing received signals that take into account the diffraction distortions of the measured electromagnetic field, which are a consequence of the scattering of incident waves on the elements max design of the antenna system of its fairing, under conditions of a priori unknown polarization of the received radio waves and an indefinite number of sources of radio radiation.

Achieving this goal required solving the following tasks: – analysis of the current state and prospective development trends theories, techniques and technologies for the production of direction-finding antenna systems topics; – research and development of signal processing methods, minimizing which influence the influence of diffraction distortions of the measured field on the accuracy of positioning, and antenna systems for their implementation in radio direction finders; – studies of promising ways to build ultra-wideband linear direction-finding antenna arrays with a beam-forming circuit based on a printed Rotman lens, which increase the sensitivity of direction finding.

At the current moment in the development of antenna systems for the design of direction-finding complexes of UAVs, it is possible to single out the design of the TCI antenna, in particular models 641, 643. In general, the design of such

an antenna is based on the general provisions described above regarding the parameters of the Vivaldi antenna. However, the key feature of such antennas is the use of ultra-broadband directional antenna elements that do not have a phase centre. The antenna contains systems of the TEM horn type (built on two identical mirror-curved relative to each other conductive plates) with strips that expand, and each of the strips is divided into two parts by a gap (analogous to the Vivaldi antenna discussed [12]). In fig. 1 a and b, respectively, present the designs of TCI antennas.



Fig. 1. Design of TCI antennas: a) TCI 643, b) TCI 647D

Analysis of the design features of antenna systems without a phase center allows us to state that the basis of the design of such ultra-broadband antennas includes a set of TEM horns and Vivaldi antennas. Among similar solutions, in the subject area of the article, it is possible to single out the Rohde&Schwarz antenna systems based on phased antenna arrays [8], symmetrical antenna vibrators and frame-type antennas [2, 11].

As stated in the statement of the research task, the proposed article examines the results of simulation of a relatively new design of the antenna [7], which is being developed for UAV direction finding and contains the TSA (Tapered Slot Antenna) concept. It should be noted that specifying a specific task for designing an antenna system gives a variety of shapes and proportions between its structural elements. The analysis of existing information on this issue revealed the following patterns for TSA: the width of the slit determines the lower frequency of the working range; the length determines the gain in the middle and at the upper edge of the frequency band; the shape of the open slit determines the frequency characteristics of the antenna element [6]. It is believed that TSA with an exponentially increasing gap width have the most acceptable frequency characteristics.

The article will present the results of modeling the characteristics of antenna elements of antenna systems using software modeling tools. ANSYS 2022 HFSS software was used as software for modeling elements of antenna systems. HFSS is an industry-standardized 3D electromagnetic simulation tool. HFSS technology allows calculation of electric and magnetic fields, currents, S -parameters, radiation fields in the near and far zone. The calculation process is fully automated, the user only needs to determine the geometric parameters, material properties and the desired result.

1. Element of an antenna system made of slotted elements of a traveling wave with printed lenses for full azimuth direction finding sources of radio emission with arbitrary polarization

The possibility of receiving and direction-finding UAV signals with arbitrary polarization is an essential technical parameter of a DF antenna system designed for compact placement on a mobile carrier. However, the analysis of modern DF antenna systems manufactured by such large manufacturers as Rohde & Schwarz, TCI, Alaris Antennas, CRFS showed that only a few of them produce DF antenna systems for receiving signals from arbitrary polarization. Therefore, the development of antenna systems of this type, taking into account the development of UAVs, is an urgent task.

In this section, an antenna system for full-azimuth direction finding of radio emission sources with arbitrary polarization in the frequency range from 1 GHz to 5 GHz, which consists of slotted elements, has been developed and studied. As a single antenna element of the developed antenna system, it is proposed to use a pair of orthogonal elements of the Vivaldi type with metamaterial polarization-selective lenses in their openings (Fig. 2).

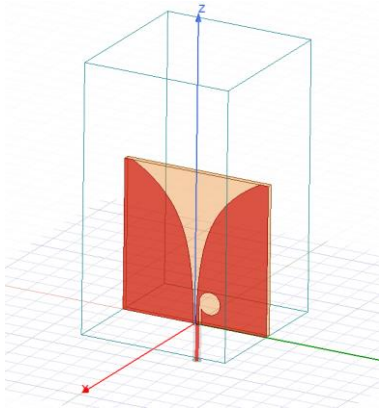

Fig. 2. Basic single antenna element of the system

The antenna elements are made according to the technology for the production of printed circuit boards on a dielectric microwave material RO4003 with double-sided metallization by Rogers. The thickness of the dielectric is 0.508 mm, overall dimensions of elements – 340 mm × 340 mm. In accordance with Fig. 1, the Vivaldi antenna is an ultra-broadband printed emitter built on the basis of an expanding slit line. In this case, a consistent transition between the non-radiating slit line and free space can be made using an exponential slit line in the form of a Vivaldi slit [6, 12]. As a result, such a design transforms traveling surface waves into radiating leakage waves. The relationship between geometric parameters and characteristics of the antenna was established experimentally [9].

A distinctive feature of the proposed embodiment of the Vivaldi antenna is the use of a printed lens in its aperture, which increases the cross-polarization isolation and improves the radiation pattern and input characteristics of the antenna elements.

2. Mathematical description of the antenna element

In accordance with Fig. 2, the Vivaldi antenna is an ultra-wideband printed radiator, which is built on the basis of an expanding slot line. In this case, a coordinated transition between the non-radiating slot line and free space can be implemented using an exponential slot line in the form of a Vivaldi slot [6, 12]. This design results in the transformation of traveling surface waves into radiating leakage waves. The relationship between the geometric characteristics and features of the antenna was established experimentally [8]. The exponential taper of a thin metal Vivaldi antenna located in the XY plane (Fig. 3) can be described by points $P1$ and $P2$ at points with coordinates $(X1, Y1)$ and $(X2, Y2)$, respectively, as well as by the opening coefficient R .

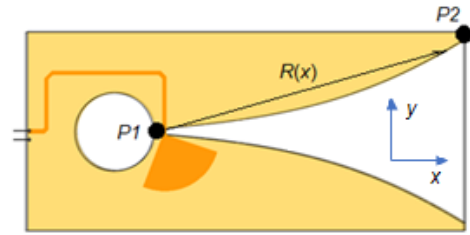

Fig. 3. Design of a Vivaldi antenna element with parameters for an analytical description

Between points $P1$ and $P2$, the exponential cone is described by the following differential equations:

$$\frac{dy}{dx} = Ry + C, \quad (1)$$

where R is the antenna opening curvature factor and C will represent the offset from y chosen so that $P1$ and $P2$ are points on the line $y(x)$, Fig. 3.

Then the general solution of equation (1) will look like:

$$y = C_1 e^{Rx} + C_2 \quad (2)$$

$$C_1 = \frac{y_2 - y_1}{e^{Rx_2} - e^{Rx_1}} \quad (3)$$

$$C_2 = \frac{y_1 e^{Rx_2} - y_2 e^{Rx_1}}{e^{Rx_2} - e^{Rx_1}}. \quad (4)$$

Thus, the mathematical model of the upper curved edge of the antenna element can be represented as:

$$\underline{R}(x) = x \underline{e}_x + |C_1 e^{Rx} + C_2| \underline{e}_y, \quad x_1 \leq x \leq x_2. \quad (5)$$

The length of the section curvature the antenna element will be described mathematically as follows:

$$l(x) = \int_{\xi=x_1}^x |\dot{\underline{R}}(\xi)| d\xi = \frac{1}{R} \left[\sqrt{1 + (C_1 R)^2 e^{2R\xi}} - \operatorname{arctanh} \left(\sqrt{1 + (C_1 R)^2 e^{2R\xi}} \right) \right]. \quad (6)$$

Thus, to represent the curves describing the petals of the Vivaldi antenna, you can use a couple of equations [6]:

$$x = x_1 + K(x_2 - x_1), \quad (7)$$

$$y = \frac{(y_2 - y_1) e^{R(x_2 + K(x_2 - x_1))} + y_2 e^{Rx_2} - y_1 e^{Rx_1}}{e^{Rx_2} - e^{Rx_1}} \quad (8)$$

The following notations are used in formulas 1–8: $\dot{\underline{R}}(\xi)$ is the derivative of $R(x)$ where R is the radius of curvature of the antenna lobe; y_1 is the antenna lobe overlap coordinate relative to the abscissa axis (Fig. 3); y_2 is the distance from the middle of the upper part of the antenna to the lobe – opened the antenna; x is a variable belonging to the interval $0 \dots x_2$ and defining the function y , which determines the change in the lobe curve from overlapping to opening the antenna; x_1 is a variable that determines the lower point of the beginning of the antenna lobe; x_2 is the lobe height and the height of the entire antenna (Fig. 2); K is the value of the coefficient.

2.1. Antenna modeling

The conducted studies have shown that without changing the design of the antenna radiator, completely different radiation patterns can be obtained by changing the phase relationships at the inputs of the antenna vibrators. This feature will be used in the construction of a UAV amplitude direction finder with high resolution. Consider the features of the development of a broadband radiator of the antenna system.

To analyse the basic element of the direction finder antenna, we performed the following stages of solution proposed research, see Fig. 4.

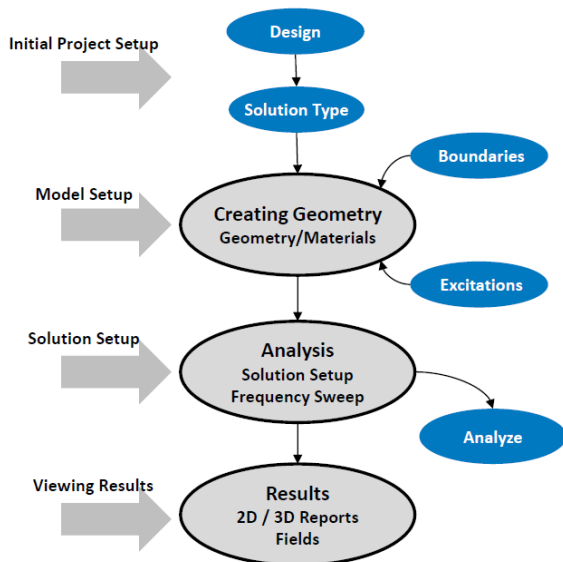

Fig. 4. Overview of solution process in ANSYS 2022 FHSS environment

During the calculations, the following was found: it is impossible to cover the required frequency range of 100–3000 MHz with a simple TSA antenna element; it is impossible to obtain an acceptable standing wave ratio (SWR) of the antenna element in a wide frequency range; the shape of the DC antenna element retains acceptable characteristics of the frequency range within an octave [10].

To eliminate these shortcomings, it is proposed to divide the design of the antenna element into three components, which must be connected according to the scheme shown in Fig. 5.

In the absence of control voltage U1 and U2, the working area of the radiating element is L1 of both radiating vibrators and the radiating element provides the necessary characteristics in the upper part of the operating frequency range.

When the control voltage U1 is applied, the working area of the radiating element is L1 together with L2. In this case, the radiating element has good characteristics in the middle part of the operating range (while they are much worse in the upper and lower parts of the operating range). And finally, when the control voltage U2 is applied, the working area of the radiating element is its entire surface, which provides good performance characteristics of the lower part of the operating frequency range.

The following characteristics of the antenna element were modeled: distribution of the E-component of the field, Fig. 6.

Simulation tools made it possible to obtain the structure of the current density distribution on the antenna surface, see Fig. 7, and the corresponding picture of the distribution of charges on the surface of the antenna, see Fig. 8.

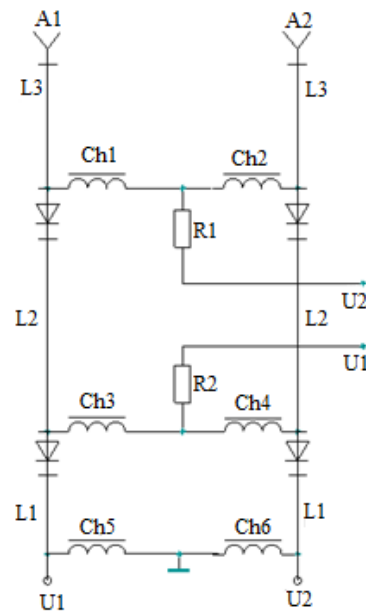

Fig. 5. Schematic diagram of the antenna element

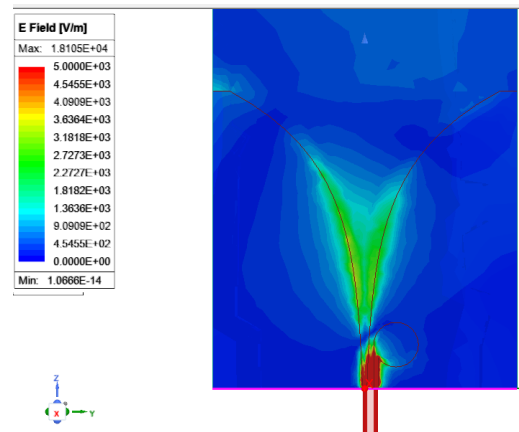

Fig. 6. Electrical component distribution, simulation in ANSYS 2022 FHSS

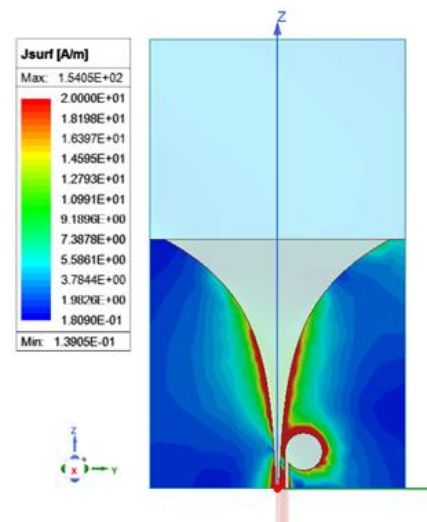

Fig. 7. Structure of the current density distribution on the antenna surface in the ANSYS 2022 FHSS environment

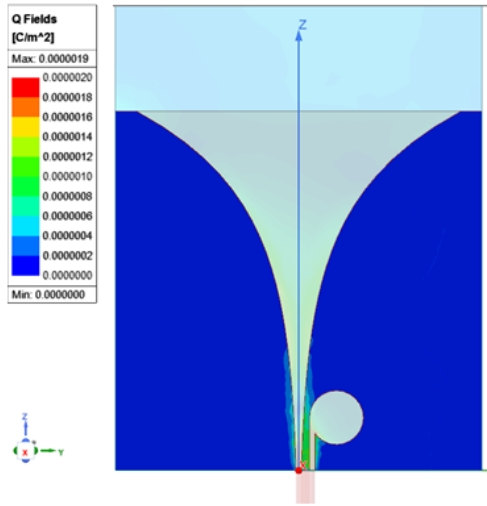

Fig. 8. Charge distributions on the surface of an antenna system element in the ANSYS 2022 FHSS environment

The directions of the Umov-Poynting vector for the antenna element were found (Fig. 9) and the pattern of losses in the space of the opening of the antenna element was determined (Fig. 10).

The input characteristics of a single element are shown in figures 11–15.

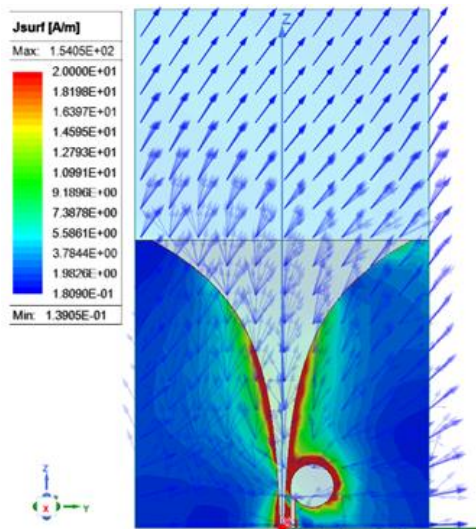

Fig. 9. Directions of the Umov-Poynting vector for an antenna element in the ANSYS 2022 FHSS environment

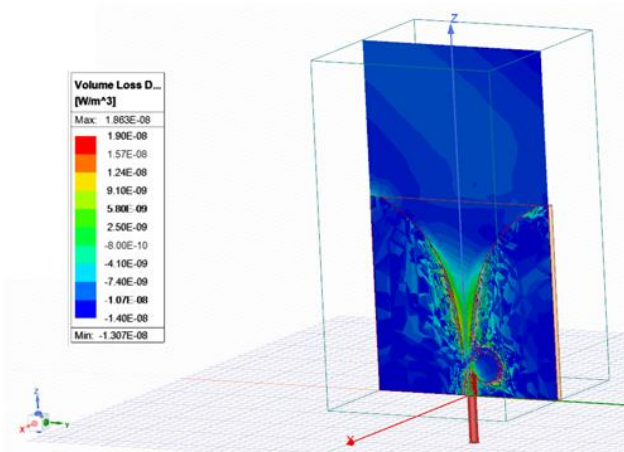

Fig. 10. The pattern of volumetric losses in the space of the opening of the antenna element

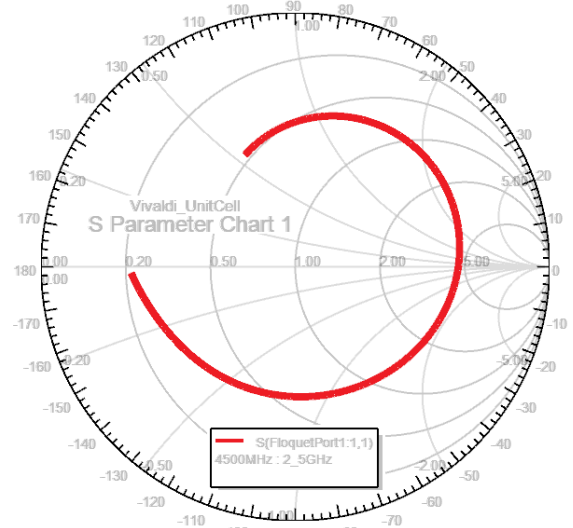

Fig. 11. Smith's nomogram of the Vivaldi antenna element (2 GHz–5 GHz)

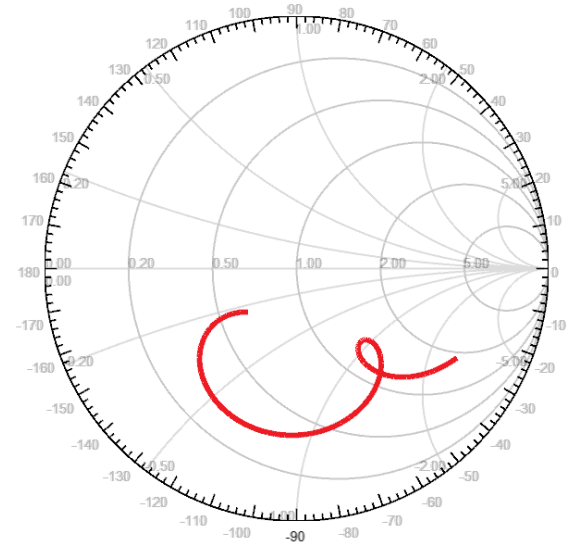

Fig. 12. Smith's nomogram of the Vivaldi antenna element (0.1 GHz–5 GHz)



Fig. 13. S-Parameter antenna element of the antenna system (2 GHz–5 GHz)

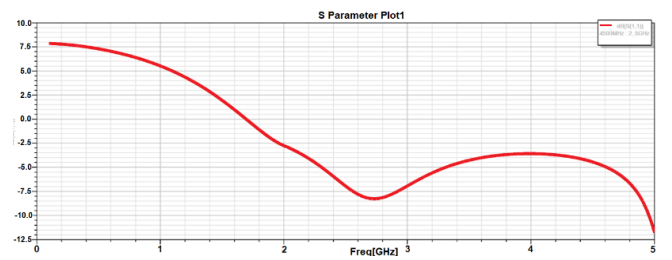

Fig. 14. S-Parameter antenna element of the antenna system (100 MHz–5 GHz)

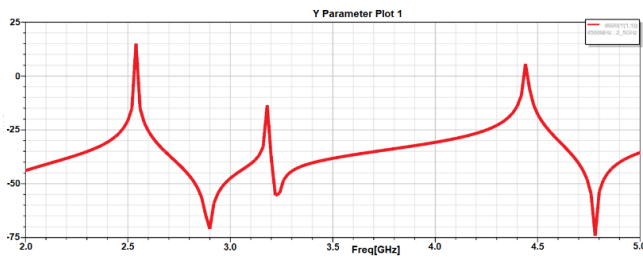

Fig. 15. Y-Parameter antenna element of the antenna system

To use the element under study as part of the radio direction finder antenna system, a two-stage amplitude-phase direction finding method is proposed, which involves the introduction of tables of mutual phases between adjacent antenna elements, for which the amplitudes of the signals received at the current time are maximum. The initial bearing estimate is determined by the amplitude method. The corrected bearing is determined by the phase distribution of the signal on the elements with the maximum amplitude. The correlation-interferometric method can also be applied.

The correlation-interferometric method can also be applied direction finding [1]. However, in this case, the antenna system will have to be supplemented with an antenna element with a circular radiation pattern, as implemented but in TCI direction-finding antenna systems [3], and tabulate the amplitude-phase radiation patterns of the elements. Thus, in this section, an antenna system for full-azimuth direction finding of radio emission sources with arbitrary polarization has been developed and studied. The advantages of the proposed design include the following:

- simplicity of design and manufacturability;
- metamaterial lenses in the apertures of antenna elements allow;
- correct phase distortions and improve their radiation pattern, input characteristics and cross-polarization isolation;
- simultaneous reception of signals on two orthogonal polarizations.

An analysis of works [2–12] shows that for direction finding antenna systems, classical vibrator antennas, less often slot antennas and TEM horns, have found the greatest application, and the most common direction-finding method is correlation-interferometric. The antenna systems themselves often have a ring geometry, while the receiving and processing equipment is located in the geometric center of the system. In the frequency range below 1 GHz, this the constructive solution does not have a noticeable effect on the parameters of the antenna system and the radio direction finder as a whole, since the radius of the antennas in the ring arrays is significantly larger than the dimensions of the receiving and processing equipment.

For the frequency range above 1 GHz, the size ratio changes significantly, and the structural elements of the receiving and processing equipment are scatterers, the dimensions of which are commensurate with the dimensions of the antenna elements of the system and their distance. As a rule, in this case, the design of the central part of the antenna is deliberately used as a reflector, which is clearly seen in the design of the ADD075 antenna system from Rohde & Schwarz [11]. This solution has some disadvantages, among which we pay attention to the linear vertical size of the central metal post. In some cases, for example, when placed on a mast, when connecting antenna systems of other frequency ranges or lightning protection elements [7], the height of the central vertical scattering structure is significantly greater than the length of the antenna elements of the system. Such a ratio of linear dimensions can lead to a significant irregularity of the antenna element radiation pattern in the vertical plane, and, as a result, to a significant decrease in sensitivity from the corresponding elevation directions, which is unacceptable for radio monitoring systems, especially UAVs.

To solve this problem, two variants of ring antenna arrays from modified dipoles [7] were developed and studied for the frequency range from 1 GHz to 5 GHz. into construction vibrators located in the immediate vicinity of the central rack, additional resistive loads are introduced to ensure the stability of the shape of the radiation pattern of each element in the array in the frequency band with an overlap factor of more than 3.

2.2. Calculation of the radiating element

The calculation of the radiating element was carried out in three stages: first, the optimal structure was calculated in the high-frequency part of the operating range, then in the mid-frequency part, and finally in the low-frequency part. On Fig. 16 shows the characteristics of the antenna element in the case of common-mode excitation in the absence of a control voltage.

On Fig. 17 shows the characteristics of the antenna element in the case of antiphase excitation in the absence of control voltages (HF part).

The simulation results allow us to study the process of changing the directional characteristic of the radiator in the operating frequency range. In particular, in Fig. 15 and Fig. 16 shows the spatial radiation patterns of the emitter and the gains in the operating frequency range.

From Fig. 16 and Fig. 17, we establish that in the frequency range of 1100–2500 MHz (HF part of the operating function) the antenna element has good characteristics in terms of antenna diagram, amplification factor and standing wave ratio (SWR) Fig. 18.

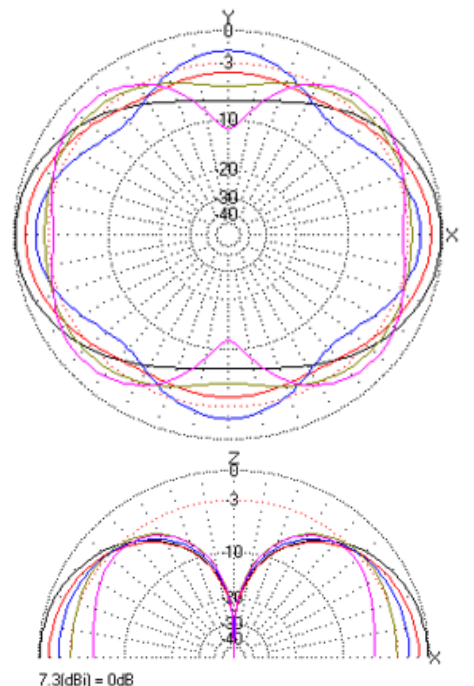

Freq	R	Γ	Ga	F/B	ON
1100.0	37.6	-666.6	7.3	-0.0	On
1450.0	8.2	-201.6	6.4	-0.0	On
1800.0	4.2	-118.2	5.5	-0.0	On
2150.0	3.6	-77.9	5.1	-0.4	On
2500.0	4.9	-49.6	5.8	-2.0	On

Fig. 16. Characteristics of the antenna element with common-mode excitation in the absence of control voltages (HF part)

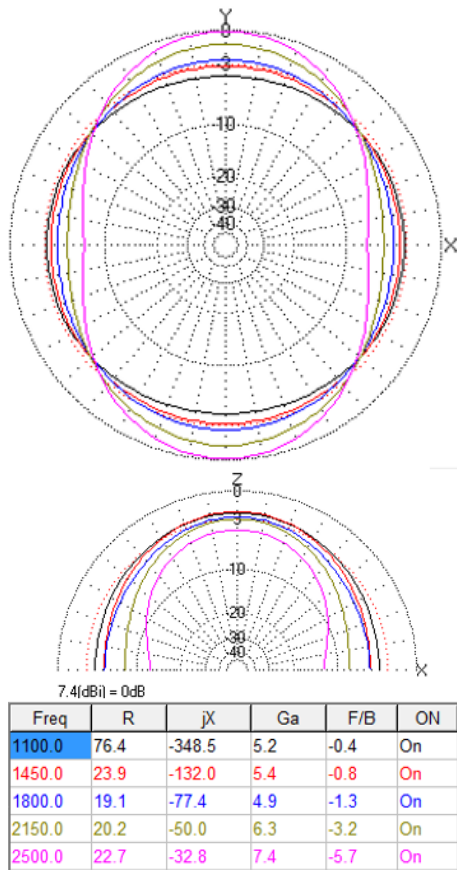

Fig. 17. Characteristics of the antenna element in the case of anti-phase excitation in the absence of control voltages (HF part)

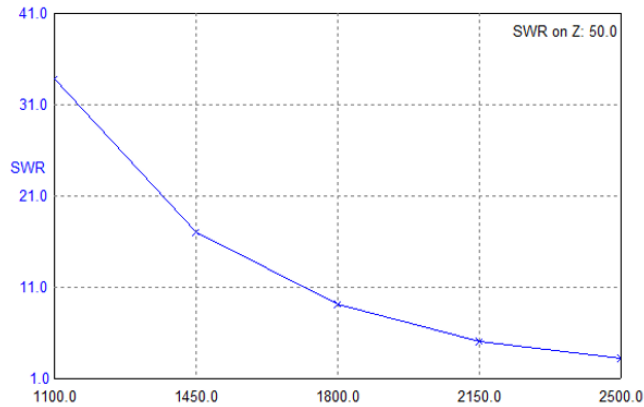

Fig. 18. SWR characteristics of the antenna element under anti-phase excitation in the absence of control voltages (HF Part)

When the control voltage U1 is applied to the main antenna element, the second segment is connected to two vibrators, which practically translates the antennas into the middle part of the frequency range. At the same time, in the HF part of the range, its characteristics deteriorate, and in the LF part of the operating range, poor matching and a low gain are observed. The working properties of the antenna element are shown in Fig. 19. The middle part of the operating range occupies the band from 400 to 1200 MHz. By applying the control voltage U2, the entire antenna structure is put into operation, providing good performance in the lower part of the operating range. At the same time, the characteristics of the antenna element in HF become even worse (antenna diagrams are distorted and side lobes appear, the presence of which is highly undesirable when building direction finding devices), and in the middle part of the range antenna diagrams deteriorate.

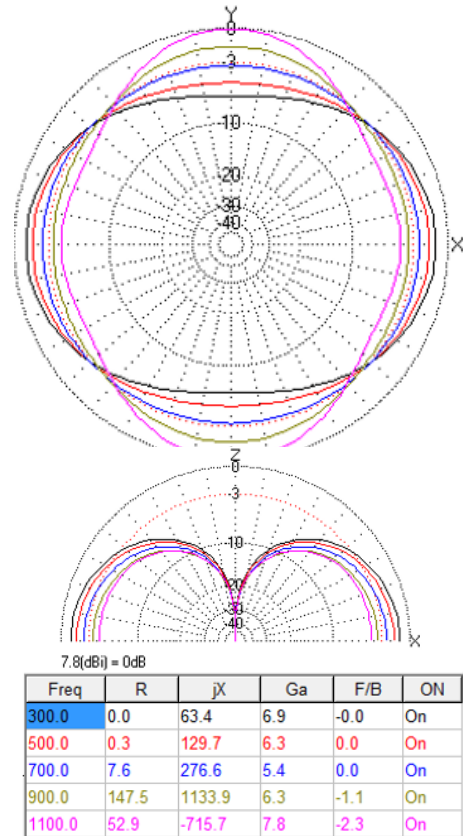

Fig. 19. Characteristics of the antenna diagram of the antenna element with common-mode excitation in the presence of a control voltage U1 (middle part of the frequency range)

The characteristics (antenna diagrams) of the antenna element with anti-phase excitation in the presence of the control voltage U2 (LF part) are presented in Fig. 20.

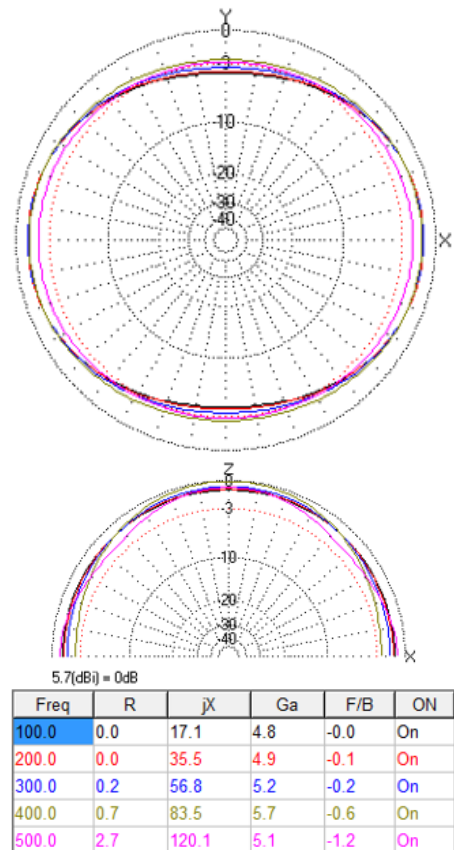

Fig. 20. The characteristics (antenna diagrams) of the antenna element with anti-phase excitation in the presence of the control voltage U2 (LF part)

Thus, by dividing the operating frequency range into three sections, it is possible to cover the frequency range of 100–2500 MHz with good performance.

Based on the simulation results, a prototype antenna was developed, Fig. 21.

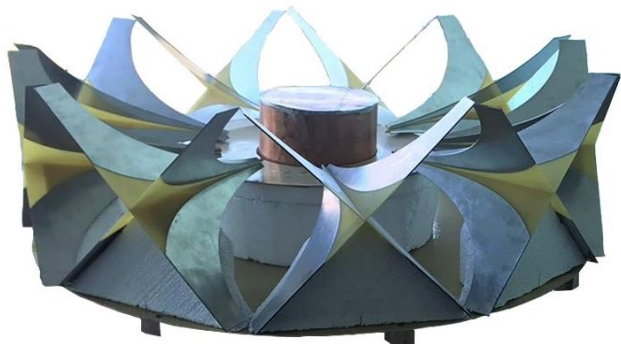

Fig. 21. Prototype of the manufactured antenna

The antenna was manufactured in the context of the implementation of a grant from the Ministry of Education and Science of Ukraine on the scientific topic "Development of a broadband direction-finding system for determining the location of military and non-military UAVs" state registration number 0122U001211.

3. Conclusion

The paper presents the results of the development and modeling of a broadband antenna system for UAV direction finding. The research covered the issues of analytical description of the antenna system based on the prototype – the Vivaldi antenna. The article presents a mathematical description of the Vivaldi antenna element model. An experimental relationship between the geometrical parameters and characteristics of the antenna has been established. A review of the current state of the issue of designing antenna systems based on the concept of constructing ultra-wideband directional antenna elements in the absence of a phase centre. The main trends in the modern design of broadband antenna systems are determined. The main parameters of the proposed broadband antenna are determined by the method of mathematical modeling. The parameters of the proposed antenna in the frequency range under various excitation conditions are investigated, and the specifics of the application of such a system under the conditions of its possible operation as part of UAV direction-finding complexes are given.

References

- [1] Boiko J., Karpova L., Eromenko O., Havrylko Y.: Evaluation of phase-frequency instability when processing complex radar signals. *International Journal of Electrical and Computer Engineering* 10(4), 2020, 4226–4236 [http://doi.org/10.11591/ijece.v10i4.pp4226-4236].
- [2] Ershadi S. E. et al.: Rotman lens design and optimization for 5G applications. *International Journal of Microwave and Wireless Technologies* 10(9), 2018, 1048–1057 [http://doi.org/10.5604/20830157.1121333].
- [3] Ghaemi K., Ma R., Behdad N.: A Small-Aperture, Ultrawideband HF/VHF Direction-Finding System for Unmanned Aerial Vehicles. *IEEE Transactions on Antennas and Propagation* 66(10), 2018, 5109–5120 [http://doi.org/10.1109/TAP.2018.2858210].
- [4] Ghamari M. et al.: Unmanned Aerial Vehicle Communications for Civil Applications: A Review. *IEEE Access* 10, 2022, 102492–102531 [http://doi.org/10.1109/ACCESS.2022.3208571].
- [5] Jensen M. A., Mahmood A., Mahmood R.: A compact low-cost direction-finding system for unmanned aerial vehicles. *Proceedings of 12th European Conference on Antennas and Propagation EuCAP 2018, London 2018*, 1–4 [http://doi.org/10.1049/cp.2018.0983].
- [6] Kazici S., Loutridis A., Caratelli D.: A Novel Class of Super-Elliptical Vivaldi Antennas with Enhanced Radiation Properties. *IEEE International Symposium*

- on Antennas and Propagation and USNC-URSI Radio Science Meeting, Atlanta 2019, 259–260 [http://doi.org/10.1109/APUSNCURSINRSM.2019.8888948].
- [7] Keshavarzian P., Okoniewski M., Nielsen J.: Active Phase-Conjugating Rotman Lens with Reflection Amplifiers for Backscattering Enhancement. *IEEE Trans. on Microwave Theory and Techniques* 68(1), 2020, 405–413 [http://doi.org/10.1017/S1759078718000934].
- [8] Parkhomey I. et al.: Assessment of quality indicators of the automatic control system influence of accident interference. *Telkomnika (Telecommunication Computing Electronics and Control)* 18(4), 2020, 2070–2079 [http://doi.org/10.12928/TELKOMNIKA.v18i4.15601].
- [9] Parkhomey I., Boiko J., Eromenko O.: Methodology for the Development of Radar Control Systems for Flying Targets with an Artificially Reduced RCS. *Journal of Robotics and Control (JRC)* 3(4), 2022, 402–408 [http://doi.org/10.18196/jrc.v3i4.15440].
- [10] Pfeiffer C.: Fundamental Efficiency Limits for Small Metallic Antennas. *IEEE Transactions on Antennas and Propagation* 65(4), 2017, 1642–1650 [http://doi.org/10.1109/TAP.2017.2670532].
- [11] R&S®ADDx Single-Channel DF Antennas Product overview [http://www.sekorm.com/doc/1094983.html] (available: 03.11.2022).
- [12] Stockbroeckx B., Vander Vorst A.: Copolar and cross-polar radiation of Vivaldi antenna on dielectric substrate. *IEEE Transactions on Antennas and Propagation* 48(1), 2000, 19–25 [http://doi.org/10.1109/8.827381].
- [13] Valavanis K. P., Vachtsevanos G. J.: *Handbook of Unmanned Aerial Vehicles –* Dordrecht, Springer 2015 [http://doi.org/10.1007/978-90-481-9707-1].

D.Sc. Eng. Juliy Boiko

e-mail: boykoym@khmnu.edu.ua

In 2002 he received a Candidate of Science degree (Ph.D.) at the Institute of Electrodynamics of the National Academy of Sciences of Ukraine in the field of device design and development of methods for measuring electrical and magnetic quantities. In 2015, he received a Doctor of Science degree (D.Sc. in Engineering) at the State University of Telecommunications (Kyiv, Ukraine) in the field of signal reception, synchronization, signal processing in telecommunication systems. Currently, Full Professor of the Department of Telecommunications, Media and Intelligent Technologies, Khmelnytskyi National University (Khmelnytskyi, Ukraine). Research includes issues related to the development of devices for the automation of devices and systems, the theory of coding, synchronization systems, diagnostics and signal processing.

<http://orcid.org/0000-0003-0603-7827>

D.Sc. Eng. Oleksiy Polikarovskiykh

e-mail: polalexey@gmail.com

In 2006 he received a Candidate of Science degree (Ph.D.) at the Vinnitsa National Technical University in the field of radio measuring instruments. In 2015, he received a Doctor of Science degree (D.Sc. in Engineering) at the State University of Intellectual Technologies and Communication (Odessa, Ukraine) in the field of signal synthesis in telecommunication systems. In 2019 Full Professor of the Department of Telecommunications, Media and Intelligent Technologies, Khmelnytsky National University (Khmelnytsky, Ukraine). Currently, Full Professor of the Department of Technical Cybernetics and Information Technologies, Odessa National Maritime University (Odessa, Ukraine). Research includes issues related to the development of devices for signal synthesis, the theory of cybersecurity and Software Defined Radio.

<http://orcid.org/0000-0002-1893-7390>

Ph.D. Eng. Vitalii Tkachuk

e-mail: tkachukvi@khmnu.edu.ua

In 2011 he received a Candidate of Science degree (Ph.D.) at the Khmelnytskyi National University of Sciences in the field machine science. Currently the head of the Department of Mechanical Engineering Technology, Khmelnytskyi National University (Khmelnytskyi, Ukraine). Scientific research includes issues related to the design and manufacture of mechanical devices and structures. Engineering analysis of the performance of mechanisms, as well as issues related to the development of means of automating devices and systems.

<http://orcid.org/0000-0003-0640-2740>

