

**Keywords:** vehicle components; high-strength steel; Hardox steel; welding

**Tomasz WĘGRZYN<sup>1\*</sup>, Bożena SZCZUCKA-LASOTA<sup>2</sup>, Tadeusz SZYMCZAK<sup>3</sup>,  
Bogusław ŁAZARZ<sup>4</sup>, Jan PIWNIK<sup>5</sup>**

## A MICRO-COOLED HIGH-STRENGTH WELD FOR HEAVY TRANSPORT MEANS

**Summary.** This paper focuses on the technical problem of repairing the main operating elements of heavy vehicles (semitrailers, dumps, and drums). If these vehicles are in service, significant changes in work schedules can occur, and costs can be generated immediately. Therefore, using the correct technology for repairs is crucial to minimizing financial and logistic difficulties. The article aims to analyze the mechanical properties of an MMA (Manual Metal Arc) welding (covered electrodes) joint made of Hardox 450 steel. This kind of material has a martensitic microstructure, which is difficult to weld because of changes in the components to the other ones during the joint process. Other inconveniences are related to the different chemical composition of steel and covered electrodes, their mechanical resistance, and thermodynamic conditions (consisting of the pre-heating temperature and the cross-pass temperature). Therefore, the joint quality should be determined using a few methods. In this case, NDT (magnetic and radiographic tests) and DT (microstructural analysis and static as well as fatigue tests) were used. All obtained results have enabled the proposed guides for the MMA welding of the steel grade. This is indicated as follows: (1) the method of bevelling the sheets before welding should be used, (2) pre-heating is necessary at temperature levels of 100 C and 125 C, and (3) the recommended interstitial temperature is between 170 C and 200°C.

### 1. INTRODUCTION

The automotive industry uses a lot of joint technology for manufacturing components and a final product in the form of different types of vehicles [1-3]. This process focuses on the production of many elements, such as frame rails, truck cabins, bumpers, EV battery protection [4], drums [3], and backhoe loaders [5]. This approach employs different methods of production: screwing, riveting, gluing, spotwelding, and welding for modern engineering materials [1, 2, 4].

The last decade has shown a trend toward the introduction of multi-material structures into car bodies. The aim is to match mechanical properties to specific loads through the use of a variety of materials. The information in Table 1 confirms the significant interest in new materials, and it presents the expected reduction in vehicle weight with the use of new materials from a given group.

---

<sup>1</sup> Silesian University of Technology; Krasińskiego 8, 40-019 Katowice, Poland; e-mail: tomasz.wegrzyn@polsl.pl; orcid.org/0000-0003-2296-1032

<sup>2</sup> Silesian University of Technology; Krasińskiego 8, 40-019 Katowice, Poland; e-mail: bozena.szczucka-lasota@polsl.pl; orcid.org/0000-0003-3312-1864

<sup>3</sup> Motor Transport Institute; Jagiellonska 80, 03-301 Warsaw, Poland; e-mail: tadeusz.szymczak@its.waw.pl; orcid.org/0000-0003-2533-7200

<sup>4</sup> Silesian University of Technology; Krasińskiego 8, 40-019 Katowice, Poland; e-mail: boguslaw.lazarz@polsl.pl; orcid.org/0000-0003-3513-811

<sup>5</sup> University WSB Merito Gdansk; Grunwaldzka 238A, 80-266 Gdansk, Poland; e-mail: j.pwiniak@pb.edu.pl; orcid.org/0000-0001-9436-7142

\* Corresponding author. E-mail: [tomasz.wegrzyn@polsl.pl](mailto:tomasz.wegrzyn@polsl.pl)

Table 1  
A new group of materials in car structure and associated weight reductions [9]

Materials	Weight reduction
Magnesium alloys	30-70%
Carbon fiber composites	50-70%
Aluminum alloys	30-60%
Titanium alloys	40-55%
Fiberglass composites	25-35%
High-strength steel and advanced high-strength steel	15-25%

The solutions primarily include new alloys, including high-strength steels, as well as customized manufacturing processes. One example is the introduction of shell structures instead of frame structures and thin-walled frame structures. These structures are made using stamping technology and welding processes that represent the most modern level of production on a significant scale in the world.

It should be emphasized that changes in materials determine changes in joining technologies, developing new solutions, and selecting appropriate parameters. Such processes must be anticipated during the design stage and then verified in tests reflecting real conditions, both in laboratory tests (programmed processes) and simulation tests (planned processes without taking external disturbances into account).

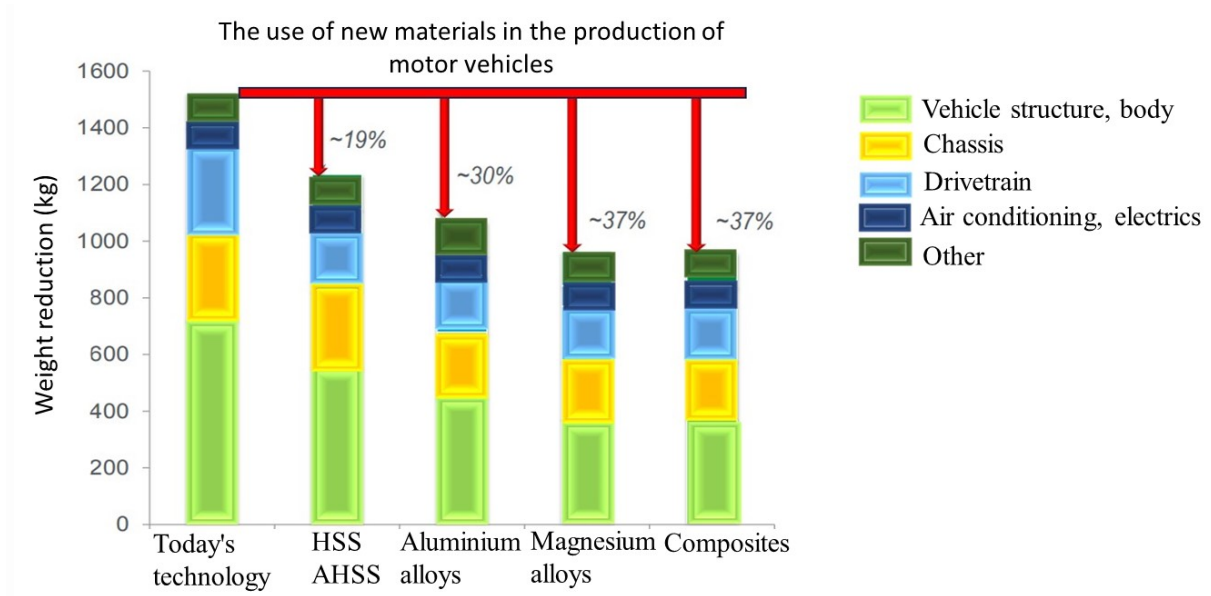

Fig. 1. Average weight reductions of vehicles using new materials (based on data presented in [9])

The final stage is the validation of the developed process, including operational tests (processes carried out under real conditions). With respect to universality and the simplicity of the welding process, manual metal arc (MMA) joining is the most popular technology [6, 7]. This is the dominant method in automotive branches of industry for manufacturing [8] and repairing different kinds of means of transport, collecting backhoe loaders [3] or concrete mixer trucks using the latest high-strength steel (HSS) grades such as Strenx [3] and Hardox [5, 3].

The use of new materials, including high-strength steel grades, makes it possible to reduce the weight of the vehicle's load-bearing structure, body, and chassis, as well as (partially) the drive system and

individual components. Depending on the components used (Fig. 1), this reduction can represent up to 70% of the total weight of the component or system.

In the case of backhoe loaders, the application of modern steel grades enables the following benefits, which can be noticed with the use of Hardox steel [5]:

- fuel reduction (278,000 L/lifetime),
- CO<sub>2</sub> savings (867 tons/lifetime),
- reduced weight (up to 25%),
- increased payload capacity (up to 15%).

A higher weight reduction for Hardox application is noticed for a drum, reaching 50% compared to the conventional element. This is possible because of the 40% reduction of the drum wall [3].

Examples of components made of Hardox, following the backhoe loader and drum truck, are shown in Figs. 2 and 3.



Fig. 2. Backhoe loader components made of Hardox steel (own research)



Fig. 3. A drum truck mixer after regeneration repair (own research)

Backhoe loader buckets and blades are structural elements with a thickness of more than 20 mm. These elements are usually welded in the metal active gas process, while other welding processes are often used in repairs, which include welding with coated electrodes. In turn, the element that rotates liquid concrete in a concrete mixer-type transport is made of a much thinner Hardox steel sheet, usually 5-6 mm thick (Fig. 3).

In the elements of the means of transport shown in Figs. 2 and 3, there is often a need to perform various types of repairs using welding processes. These processes must be universal and applicable in the place of their work, for example, at the construction sites of various types of buildings. For this kind of vehicle repair, coated electrodes are used very often.

An important factor preventing breakdowns in the production and operation of automobiles is the proper selection of technology, welding electrodes, and an in-depth analysis of the physical properties of the weld. According to the standards in force in the European Union, the most important choice for assessing the suitability of various welding electrodes for the production of steel structures is the value of impact strength, temporary tensile, and fatigue strength of the weld. The purpose of this kind of test for quality is confirmed in other approaches to automotive components [10-11]. The rules indicated above are put forth in the CEN standard EN499. Currently, mostly austenitic-coated basic electrodes are used as coated electrodes for welding Hardox [11].

The choice of the alloy elements in the base material and weld is very important because of the fine microstructure, strength parameters, and impact strength. The basic alloying elements of these steel electrodes are nickel and chromium, and they are selected to ensure an austenitic structure [12, 13]. In low-alloy electrodes, the manganese content usually does not exceed 1%, and the silicon content is at the level of 0.5%. With higher amounts of these additives in metal deposits, their ultimate tensile strength increases significantly, but opinions are divided [14, 15].

Attempts to add V to alloys did not bring sufficiently positive results due to the effect of hardening the heat-affected zone (HAZ) by MAC phases (martensite + bainite, residual austenite, and carbide

phases). The electrodes for welding joints intended to work, especially in negative temperatures, are currently made, inter alia, as basic electrodes [16, 17]. The nitrogen content in these alloys of low-alloy electrodes may vary, especially in the type of (a) the electrode wire (nitrogen amount in it, among other elements), (b) the coating composition and its thickness, (c) the arc length during welding, and (d) the type of protective gas mixtures. The amount of oxygen in the weld deposit of austenitic basic electrodes depends mainly on the kind of coating and the kind of shielding gases. The carbon content in coated electrode alloys is twice as low as in Hardox 450 and is usually approx. 0.1%. Phosphorus and sulfur additions are treated as unfavorable elements.

The total content of phosphorus and sulfur should not exceed 0.03% [18, 19]. The aim of this paper is to show the results of the research leading to the selection of MMA (Manual Metal Arc) welding parameters for the structures made of Hardox 450 steel in the automotive sector. A large part of the currently conducted research concerns the development of steel joints with a high ultimate tensile strength (UTS) and fatigue resistance using new additional materials and innovative welding technologies [20-24].

## 2. MATERIALS AND METHODS

Usually, the wall thickness of a drum truck mixer is 5 mm. This means the component can be marked as a thick-walled construction. From a joining point of view, this expresses the joint process is not trivial, and this should be designed in detail. Therefore, the technology of regenerative repair of the component was proposed for plates made of Hardox 450 steel. The thickness was 5 mm. Austenitic INOX B 307 coated electrodes (EN-ISO 3581) were used for the welding of Hardox grade steel. Before the welding process, pre-heating was done at a temperature of 125°C. Table 2 presents some properties of Hardox steel.

Table 2

Selected mechanical parameters of the tested material (Hardox 450 steel)

Yield point YS, MPa	Ultimate tensile UTS, MPa	Hardness HB	UTS/HB
1150	1350	450	3.0

The additional test showed the ratio between ultimate tensile strength and hardness because if hardness values are collected, then UTS values can be easily determined. A comparison of the mechanical parameters' values indicates that the region for steel hardening is very small; it is represented by 200 MPa only (Fig. 4).

This reflects that engineering approaches by means of modeling and calculations should be conducted significantly below yield stress to avoid unexpected situations where the stress due to operation captures value from the region represented between the yield point and the UTS. The composition of Hardox 450 steel is presented in Table 3.

The microstructure and composition of austenitic electrode wire differ from the chemical composition of martensitic steel (Table 4).

The joint was made in the sloping position (PA). The dimensions of the specimens were 5 mm × 280 mm × 400 mm.

The dominant microstructure of Hardox 450 is represented by martensite, while the austenitic microstructure is in the coated electrodes. Before commencing the execution of joints, V-chamfering (60°) was performed (Fig. 5).

The welding process parameters were:

- electrode wire: 3.25 mm,
- voltage: 20 V,
- current: 135 A,
- direct current, polarity "+",
- the nature of the joint: multi-run.

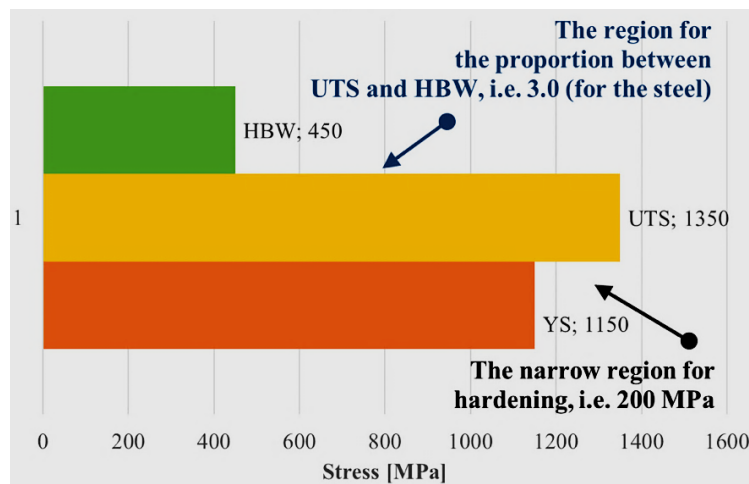

Fig. 4. Comparison of mechanical parameters and the stress value for the Hardox 450 steel hardening (own research)

Composition of Hardox 450 steel

Table 3

C, %	Si, %	Mn, %	P, %	S, %	Cr, %	Ni, %	Mo, %	B, %
0.27	0.72	1.62	0.024	0.011	1.4	1.5	0.6	0.005

Covered electrode deposit – consistency

Table 4

Electrode	C, %	Si, %	Mn, %	P, %	Cr, %	Ni, %
INOX B 307	0.12	0.6	6.1	0.010	18	8.5

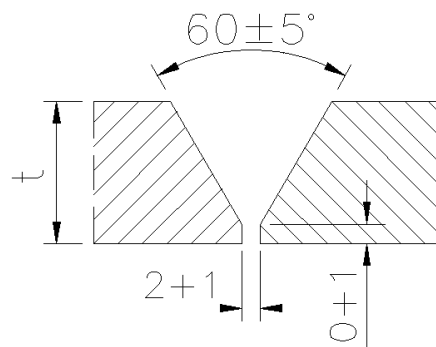

Fig. 5. Preparation of the steel edges before welding

The austenitic basic electrodes were dried for two hours at 350°C before welding. The pre-heating temperatures were 100°C and 125°C. The interstitial temperature was controlled at 170°C and 200°C.

Non-destructive tests (NDTs) were divided into:

- Visual tests realized with EN ISO 17638,
- Magnetic particle testing realized with EN ISO 17638,
- Radiographic tests realized with PN EN ISO 15614-1.

Destructive tests were divided into:

- Tensile,
- Fatigue,
- Determination of H<sub>2</sub> content in the weld.

The diffusible hydrogen content was counted in the tested joints [22]. Tests on the content of H in the weld were carried out according to the illustrative glycerin method BN-64/4130 [19].

The static and fatigue tests were realized on an 8874 INSTRON machine at room temperature. In the static test, the displacement velocity was 1 mm/min. The fatigue tests were expressed by the following values:  $R = -1$  and stress amplitude equal to 270 MPa, 350 MPa, Figs. 6, 7. A 2620-602 axial INSTRON extensometer with a gauge length of 12.5 mm. A measuring range of  $\pm 2.5$  mm was used to follow changes in values of axial strain.

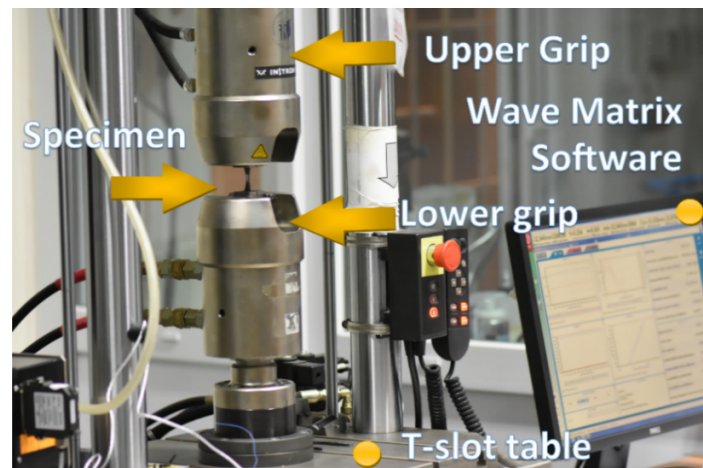

Fig. 6. Instron 8874 servo-hydraulic biaxial testing machine

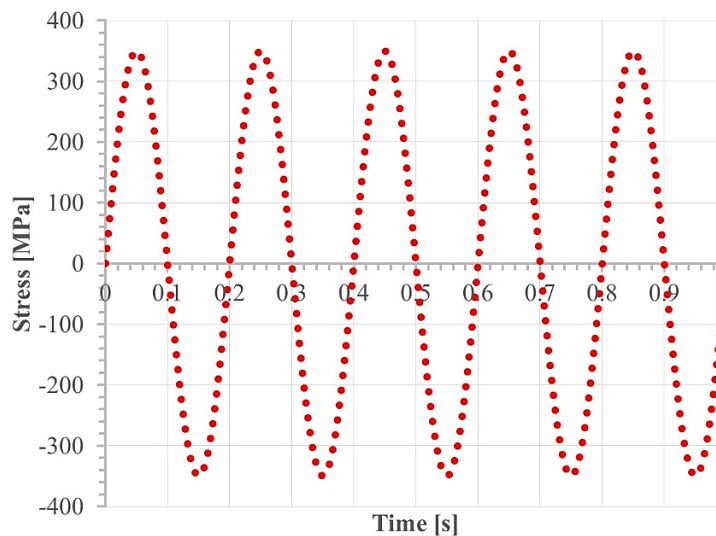

Fig. 7. Stress versus time for the fatigue test

### 3. RESULTS AND DISCUSSION

Before welding was performed, the electrodes were carefully dried at 350°C to eliminate moisture and ensure low hydrogen and oxygen amounts in the fusion zone. Nevertheless, we decided to make test joints with different variants of pre-heating and with different temperatures of interstitial layers. Thermodynamic welding parameters have a big impact on the method of heat dissipation in the joint, which can lead to undesirable stresses and, as a result, cause welding cracks. In Hardox steels, welding cracks are additionally favored by martensitic structures. Therefore, it is always necessary to carefully select various process parameters to ensure the best possible physical properties of the joint and not to

expose it to cracking. The joints were made without pre-heating and with pre-heating at temperatures of 100°C and 125°C. The results of the initially realized NDTs are presented in Table 5.

Non-destructive test results

Table 5

Pre-heating temperature, °C	Temperature of interstitial layers, °C	Observations
Room temperature	170	Cracks in the weld and HAZ
Room temperature	200	Cracks in the weld and HAZ
100	170	No cracks
100	200	Cracks in the weld
125	170	No cracks
125	200	No cracks

It was discovered that pre-heating before welding and controlling the interpass temperature are important for getting a good-quality joint. Initially, it was concluded that the pre-heating temperature of 125°C before welding is the most appropriate, as no defects were observed in joints in both tested cases (inter-stitch temperature equal to 170°C and 200°C). It has additionally been noted that pre-heating to 100°C while controlling the interpass temperature at 170°C also achieves a proper joint. In the remaining joints, defects were present. The next program of the research was to count diffusible hydrogen in the fusion zone. Only those cases where there were no welding defects or non-conformities were analyzed. The test results are given in Table 6 and Fig. 8.

Diffusing hydrogen content [ml/100 g of corrective weld]

Table 6

Pre-heating temperature, °C	Temperature of interstitial layers, °C	H content, ml/100 g of weld
100	170	4.7
125	170	4.5
125	200	4.7

In all tested cases, it was found that the hydrogen content did not exceed 5%. It has been noticed that the lowest diffusible hydrogen content is in the weld prepared with parameters: pre-heating to 125°C and a temperature of interstitial layers of 170°C.

For comparative purposes, the amount of H in the joint made without pre-heating was checked.

The presence of too much H in the weld metal deposit may explain the cracks shown in Table 7. The next part of the investigation was to determine the properties of the joints.

Table 8 gives the tensile strength of the weld made with different thermodynamic parameters (average of three measurements). The table clearly shows that an acceptable value of the tensile strength of the joint can be obtained even with a value slightly over 500 MPa).

Such a result was reached only in the case when pre-heating at 125°C was used while ensuring that the interstitial temperature did not exceed 170°C. This can be very easily obtained based on the data shown in Fig. 9.

The strength of the joints made in the other two cases was slightly lower. Finally, a bending test of all samples was tested. Table 9 gives the results of the bending test (EN ISO 5173) at the thickness of the tested welding test of 5 mm. Specimen width  $b = 20$  mm, bending mandrel diameter  $d = 34$  mm, support spacing 40 mm at the required bending angle of 180°. The bending test was carried out twice from the root side and face side of the sample. The bending test resistance is an important supplement



to tensile strength testing. These tests allow for the verification and validation of the properties of the joint. No defects were present in the weld when the pre-heating temperatures were 100°C and 125°C.

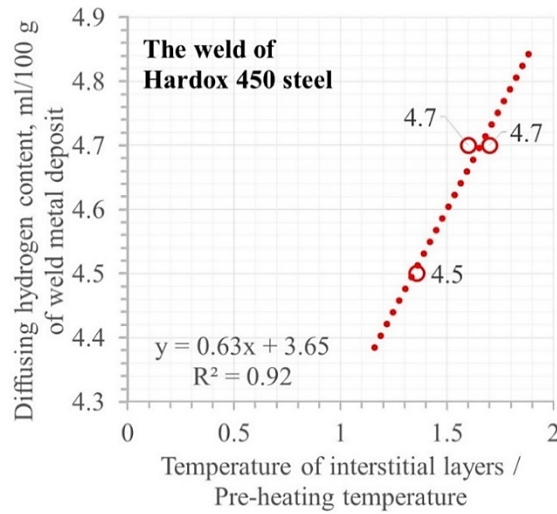

Fig. 8. Diffusion hydrogen content versus proportion represented by temperature of interstitial layers and preheating one

Table 7

H content [ml/100 g of defective weld]

Pre-heating temperature, °C	Temperature of interstitial layers, °C	H content, ml/100 g of weld metal deposit
20	170	5.8

Table 8

Tensile strength in terms of temperature used in the welding process

Pre-heating temperature, °C	Temperature of interstitial layers, °C	UTS, MPa
100	170	472
125	170	501
125	200	483

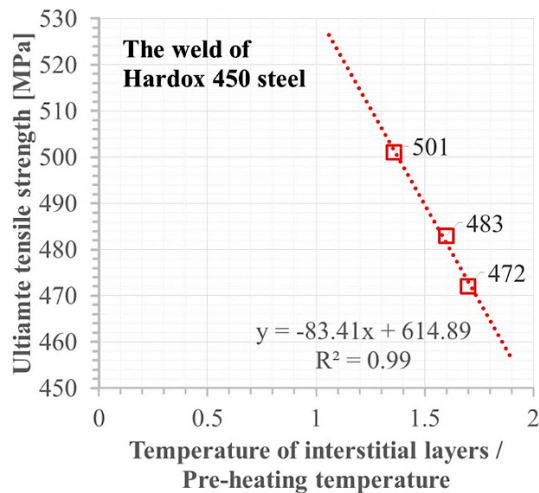

Fig. 9. Ultimate tensile strength versus the proportion represented by temperature of interstitial layers and pre-heating temperature



Based on the data in Table 9, it can be stated that the most important thermodynamic parameter of the process is the temperature of the interstitial layers, which should not exceed 170°C (specimens denoted as Pr1, Pr3). No welding defects or non-conformities were found for these joints. No cracks were found in the weld or in the HAZ on either the root or face side. A joint made with an excessively high interstitial temperature of 200°C cracked in the bending test from the root side (once in the heat-affected zone and once in the weld).

Table 9

## Bending test results for the welded joint

Specimen No.	Pre-heating temperature, °C	Temperature of interstitial layers, °C	From face side	From root side
Pr1	100	170	No cracks	No cracks
Pr2	125	170	No cracks	No cracks
Pr3	125	200	No cracks	Cracks in the HAZ

The selected parameters of the fatigue test for the Hardox 450 joint after MMA welding with the use of austenitic basic electrodes are shown in Table 10. Values of stress amplitude ranged from 270 MPa to 350 MPa. They applied to follow a fatigue limit for all types of welds considered.

Changes in values of ultimate tensile strength can also be analyzed with respect to the proportion between temperature for interstitial layers and pre-heating. This enables us to observe a reduction of the mechanical parameter if the value for the relationship increases. As can be noticed, the change range can be covered by a wide region. This means 450 MPa can reflect the ultimate tensile strength for the proportion equal to 2.0. From a practical point of view, these data allow us to indicate the mechanical parameter values for the temperature levels used.

This reflects results from the test under displacement cyclic signal. These data, illustrated (Fig. 10) as a proportion of the temperature of interstitial layers and pre-heating temperature versus the number of cycles, enabled us to indicate durability at the temperature values selected for both values of stress used (i.e., 350 MPa and 270 MPa). Of note, at a higher value of stress, more details about the weld type can be obtained because this enables us to collect regions denoted by values of the temperature and number of cycles.

Table 10

## Fatigue test results (specimen Pr2)

Pre-heating temperature, °C	Temperature of interstitial layers, °C	Stress, MPa	Number of cycles
100	170	350	746 397
125	170	350	829 611
125	200	350	737 108
100	170	270	1 998 463
125	170	270	Over 2 million
125	200	270	1 977 933

Therefore, it might be concluded that the resistance of Hardox grade steel is reduced with increasing temperatures of interstitial layers or by lowering the value of pre-heating temperature.

The analysis of the table presents that the joint has a fatigue limit on the stress value of 270 MPa. The best mechanical properties were again obtained for weld made with pre-heating to the temperature of 125°C and with monitoring the inter-pass temperature at the level of 170°C. The remaining joints have slightly lower fatigue strength.

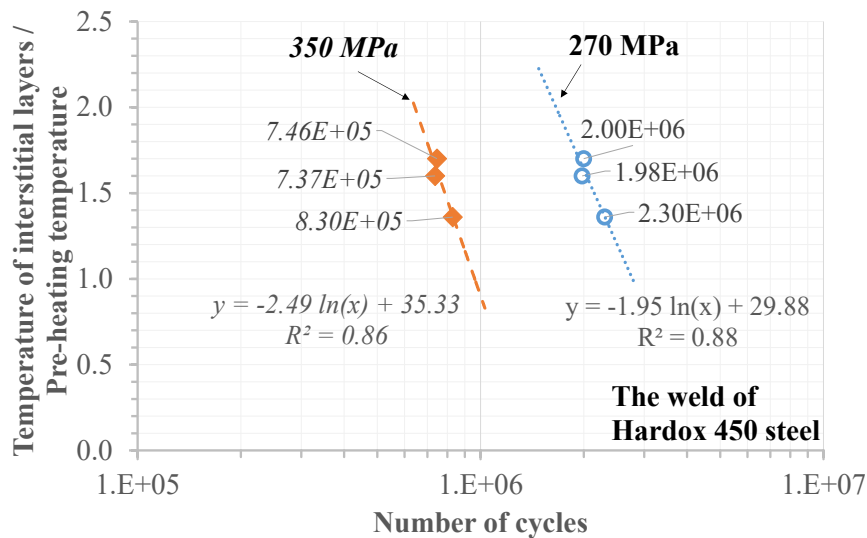

Fig. 10. Temperature of interstitial layers/pre-heating temperature versus the number of cycles for two values of cyclic stress (i.e., 350 MPa and 270 MPa)

The last part of the investigation was carried out to analyze the impact of the toughness of welds. Table 11 shows that the joint meets the second class of impact toughness and that all measurements (with different variants of the notch) have breaking energies above the threshold value of 47 J.

Table 11

Impact toughness results (specimen Pr2)

Place incisions of notch	KV (-20°C) measurements, [J]	Rounded average of KV (-20°C) measurements, [J]
Weld	56 55 51	54
HAZ	48 49 49	49

This means the joint can be selected for engineering applications, especially for the various means of transport structures.

As the last part of the investigation, SEM observations were carried out (Fig. 11).

Small nonmetallic inclusions were determined (especially TiC and TiN). Their presence is very desirable because they strengthen the joint and give it properties more similar to those of the native material. The formation of inclusions, as well as their size and arrangement, is influenced by the thermodynamic conditions of the process, especially the pre-heating temperature and the interpass temperature. Both of these values were carefully selected in the studies.

#### 4. CONCLUSIONS

Newly developed materials with increasingly favorable mechanical, physical, and chemical properties are selected for the structure of some means of transport [9, 25]. At the same time, there is an interest in new technologies that improve the quality of motor vehicles and other means of transport. Welded joints occur in all means of transport. Welding processes are important in the practice of drum

truck mixers. MMA welding is a universal welding method, but it is rarely applied for Hardox, which is used to make different types of drum truck mixers.

**Base(2)**

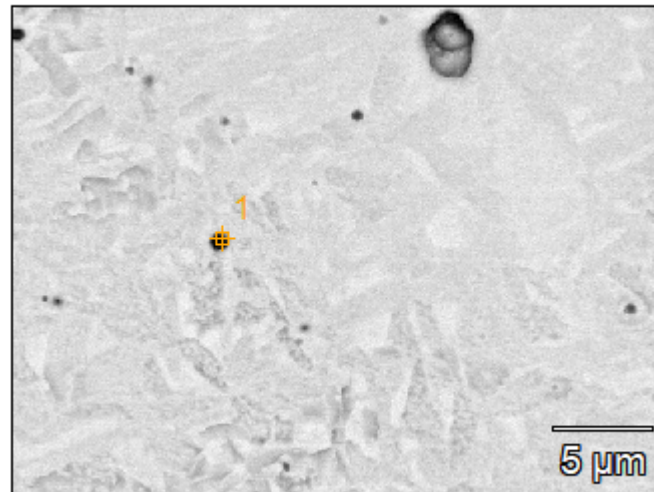

Full scale counts: 8472

Integral Counts: 421119

**Base(2)\_pt1**

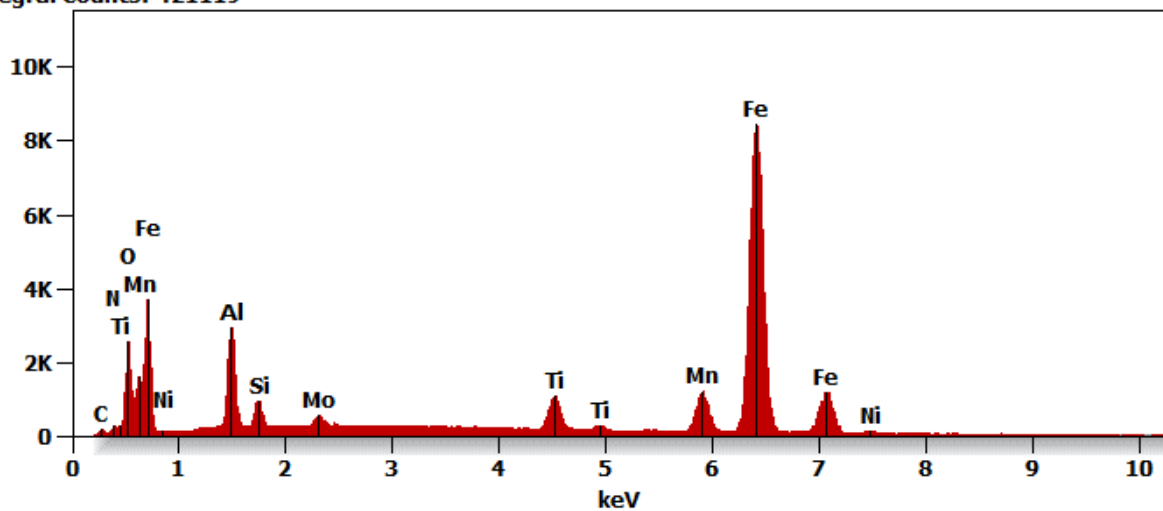

Fig. 11. Nonmetallic inclusions (mainly TiN and TiC) in sample Pr2

The present article analyzes the possibilities of correct regeneration repairs of the mentioned component with the use of austenitic electrodes. We decided to test the impact of thermodynamic conditions on the properties of a joint made with coated austenitic electrodes. For this purpose, joints were made with pre-heating and without pre-heating. At the same time, the influence of pre-heating at 100°C and 125°C and interstitial temperatures at 170°C and 200°C were applied. The H amount was analyzed in all the test joints made. The NDT and tests of H amount evaluation in 5-mm-thick Hardox 450 welds clearly indicated that the use of pre-heating is necessary. In main tests, welds were made with the use of pre-heating 100°C and 125°C. Tensile and bending tests and a fatigue experiment were performed. Based on the tests, it can be concluded that the pre-heating temperature should be 125°C, and the inter-pass temperature should be 170°C. All test results were confirmed by impact toughness tests, which are the most important and universal tests used to assess the quality of welds. It is confirmed that the welding joints in the drum truck mixer elements meet the high second impact strength class.

Welding Hardox 450 steel with austenitic basic electrodes enables the creation of a good-quality joint. Based on the results of the paper, the following conclusions can be given:

- the welding process can be directly used for repairing vehicle components made of Hardox steel
- pre-heating at 125°C is recommended before the MMA welding of the steel,
- it is possible to get the tensile strength of the joint at 500 MPa,
- it is possible to get the fatigue strength of the joint at 270 MPa.

The solution to the welded problem could be used for the reparation of high-loaded transportation means (e.g., drum truck mixers) in the automotive industry.

## Acknowledgments

The article was written as a part of the COST project, CA 18223, and project UIDB/00151/2020, The AeroMaS - Aerospace Materials and Structures Group of the CMAST - Centre for Mechanical and Aerospace Science and Technologies.

## References

1. *The automotive aluminum manual*. European Aluminium Association. 2013. 84 p.
2. Automotive Advanced High Strength Steel (AHSS) Market Professional Survey Report 2019. December 4, 2019.
3. *Hardox® 450 in concrete mixer drums enables a saving of one in six loads*. Available at: <https://www.ssab.com/en/news/2015/04/hardox-450-in-concrete-mixer-drums-enables-a-saving-of-one-in-six-loads>.
4. *AHSS/UHSS applications for trucks and light commercial vehicles*. Available at: <https://www.ssab.com/en-us/brands-and-products/docol/ahss-uhss-applications-for-heavy-trucks>.
5. *Less weight makes light work*. Available at: <https://www.ssab.com/en-ca/brands-and-products/hardox/customer-cases/2019/ecougraded-mining-backhoe-bucket>.
6. *Welding handbook. A guide to better welding of hardox and strenx*, HB051 – Welding handoon-UK-V2-2019. Höglund Design AB, Österbergs & Sömlandstryck. Edition 2, SSAB, 2019. 135 p.
7. *Welding of AHSS/UHSS steel, A guide for the automotive industry*, en-Docol – Welding handbook-v2-2022. Confetti, SSAB. 2022. 56 p.
8. *Welding of Hardox*, 103- en-Welding Hardox® wear plate- V2-2020- AplusM-Österbergs Trucker. SSAB. 2020. 24 p.
9. Herrmann, C. & Dewulf, W. & Hauschild, M. & Kaluza, A. & Kara, S. & Skerlos, S. Life cycle engineering of lightweight structures. *CIRP Annals*. 2018. Vol. 67(2). P. 651-672. DOI: <https://doi.org/10.1016/j.cirp.2018.05.008>.
10. Kozłowski, E. & Borucka, A. & Szymczak, T. & Świdorski, A. & Gil, L. Predicting the fatigue life of a ball joint. *Transport and Telecommunication*. 2021. Vol. 22. No. 4. P. 453-460.
11. *Middle Concrete Mixer Truck*. Available at: [https://www.sanqgroup.com/concrete\\_mixer\\_truck](https://www.sanqgroup.com/concrete_mixer_truck).
12. Darabi, J. & Ekula, K. Development of a chip-integrated micro cooling device. *Microelectronics Journal*. 2016. Vol. 34. No. 11. P. 1067-1074. DOI: <https://doi.org/10.1016/j.mejo.2003.09.010>.
13. Jaewson, L. & Kamran, A. & Jwo, P. Modeling of failure mode of laser welds in lap-shear specimens of HSLA steel sheets. *Engineering Fracture Mechanics*. 2011. Vol. 1. P. 347-396.
14. Evans, G.M. *The effect of micro-alloying elements on the microstructure and properties of ferritic all-weld metal deposits*. IIW Doc II-A-855-92. 1992. P. 1-20.
15. Hadryś, D. Impact load of welds after micro-jet cooling. *Archives of Metallurgy and Materials*. 2015. Vol. 60. No. 4. P. 2525-2528. DOI: <https://doi.org/10.1515/amm-2015-0409>.
16. Golański, D. & Chmielewski, T. & Skowrońska, B. & Rochalski, D. Advanced Applications of Microplasma Welding. *Biuletyn Instytutu Spawalnictwa w Gliwicach*. 2018. Vol. 62. No. 5. P. 53-63. DOI: <http://dx.doi.org/10.17729/ebis.2018.5/5>.

17. Silva, A. & Szczucka-Lasota, B. & Węgrzyn, T. & Jurek, A. MAG welding of S700MC steel used in transport means with the operation of low arc welding method. *Welding Technology Review*. 2019. Vol. 91. No. 3. P. 23-30.
18. Krupicz, B. & Tarasiuk, W. & Barsukov, V.G. & Sviridenok, A.I. Experimental evaluation of the influence of mechanical properties of contacting materials on gas abrasive wear of steels in sandblasting systems. *Journal of Friction and Wear*. 2020. Vol. 41. No. 1. P. 1-5.
19. Shwachko, V.L. Cold cracking of structural steel weldments as reversible hydrogen embrittlement effect. *International Journal of Hydrogen Energy*. 2000. Vol. 25. No. 5. P. 473-480.
20. Mazur, M. & Grela, P. Badania porównawcze wodoru dyfundującego ze stopiwa metodami glicerynową i rtęciową. *Biuletyn Instytutu Spawalnictwa*. 2002. Vol. 1. [In Polish: Comparative studies of hydrogen diffusing from the weld metal using the glycerine and mercury methods. *Bulletin of the Welding Institute*].
21. Łabanowski, J. & Fydrych, D. Oznaczanie zawartości wodoru dyfundującego w stopiwie. *Prace Naukowe Politechniki Warszawskiej*. II Sympozjum Naukowe Zakładu Inżynierii Spajania Politechniki Warszawskiej. Warsaw 2008. [In Polish: Determination of the content of hydrogen diffusing in the weld metal. *Scientific works of the Warsaw University of Technology*. 2nd Scientific Symposium of the Department of Bonding Engineering, Warsaw University of Technology].
22. PN-EN ISO 3690: 2005. *Spawanie i procesy spawaniu pokrewne - Oznaczanie zawartości wodoru w stopiwie ferrytycznym wykonanym łukowo*. Warszawa: Polski Komitet Normalizacyjny. [In Polish: *Welding and related welding processes - Determination of hydrogen content in ferritic arc weld metal*. Warsaw: Polish Committee for Standardization].
23. Kasuya, T. & Hashiba, Y. & Ohkita, S. & Fuji, M. Hydrogen distribution in multipass submerged arc weld metals. *Science and Technology of Welding & Joining*. 2001. Vol. 6. No. 4. P. 261-266. DOI: <https://doi.org/10.1179/136217101101538767>.
24. Skowrońska, B. & Szulc J. & Chmielewski T. & Golański D. Wybrane właściwości złączy spawanych stali S700MC wykonanych metodą hybrydową plazma + MAG. *Welding Technology Review*. 2017. Vol. 89. No. 10. P. 104-111. [In Polish: Selected properties of welded joints of S700MC steel made using the hybrid plasma + MAG method]. DOI: <http://dx.doi.org/10.26628/ps.v89i10.825>.
25. Świdorski, A. & Borucka, A. & Jacyna-Golda, I. & Szczepański, E. Wear of brake system components in various operating conditions of vehicle in the transport company. *Eksploracja i Niezawodność-Maintenance and Reliability*. 2019. Vol. 21. No. 1. P. 1-9. DOI: <http://dx.doi.org/10.17531/ein.2019.1.1>.