



# Assessment of T6 Heat Treatment Effectiveness of Hypo-eutectic Silumins with Limited Parameters of Solutioning Treatment

**J. Pezda**

University of Bielsko-Biala, ATH,

ul. Willowa 2, 43-309 Bielsko-Biała, Poland

Corresponding authors. E-mail address: jpezda@ath.bielsko.pl

Received 11.12.2019; accepted in revised form 07.02.2020

## Abstract

Heat treatment processes, due to qualitative requirements for the cast machinery components and restrictions on energy consumption resulting on the one hand from environmental concerns, and on the other hand from a requirements coming from minimization of manufacturing costs, are resulting in searching after a technologies enabling obtainment of satisfactory results, in form of improved mechanical properties mainly, while minimizing (limiting) parameters of successive operations of the heat treatment. Heat treatment of the T6 type presented in this paper consists in operations of heating of investigated alloys to suitably selected temperature (range of this temperature was evaluated on the base of the ATD method), holding at such temperature for a short time, and next rapid cooling in water (20 °C) followed by artificial ageing, could be such technology in term s of above mentioned understanding of this issue. Performed T6 heat treatment with limited parameters of solutioning operation resulted in visible increase in tensile strength  $R_m$  of AlSi7Mg, AlSi7Cu3Mg and AlSi9Cu3(Fe) alloys.

**Keywords:** Silumins, Heat treatment, Ultimate tensile strength

## 1. Introduction

The Al-Si alloys (silumins) belong to the most numerous groups of casting alloys based on aluminum [1-3]. The alloys, because of their mechanical properties, relatively good fluidity and low specific gravity and corrosion resistance, are used mainly in metal and automotive industries [4-6]. To production of automotive structural elements are used mainly the alloys, denominated according to the Aluminium Association system as from 3xx.x series (Al-Si-Mg, Al-Si-Cu, Al-Si-Cu-Mg). Most of powertrain components (80-85%) are cast from aluminum alloys,

others are produced in process of rolling, extrusion and forging mainly. Among components received from casting process the biggest share belongs to cylinder heads, casings of transmission gears, cylinder blocks and various engine components (cylinder head covers, oil pans, water and oil pump housings, collectors, housings and rotors of turbo-compressors). Wheel rims, cylinder linings, slide bearings and pistons are also produced as a castings. The silumins are characterized by a soft metallic matrix and hard precipitations of silicon. Main role in shaping properties of such alloys belongs to volume fraction and morphology of microstructural components [1-3,7], and to a possible heat

treatment, as it occurs in case of alloys with additives of Mg and Cu [8-10].

Requirements for the mechanical properties, course of casting process and chemical composition, as well as structure of the alloy, all of them affect directly on parameters of the heat treatment process (time and temperature of solutioning and ageing). The main condition, being basis of the precipitation hardening of the alloys, is changing solubility of alloying components in solid state, growing as temperature increases [11-13].

Heat treatment of the T6 type in case of the alloys from 3xx.x series comprises three stages:

- *solution heat treatment* having activated diffusion mechanisms and resulting in change in morphology of eutectic silicon [1-2, 14-17],
- *rapid cooling* allowing for entrapping of existing vacancies and atoms of alloying components in supersaturated solid solution [1,18,19] by placing the element in water, in brine solutions, in fluidized beds, in aqueous solutions of polymer, or cooling with compressed air, or cooling in hot (60-90 °C) water [20-22].
- *natural ageing* (at room temperature), or *artificial ageing* (at elevated temperature) [10,12,13]; to precipitation from the solution of finely-dispersed and hardened phase.

To obtain homogenous supersaturated structure of the alloy, heating operation is performed at temperature which is lower with 20-30°C than eutectic temperature, due to existing risk of generation of surface defects and possible partial melting of eutectic mixture.

Time required to the homogenization is determined by solutioning temperature and spacing of dendrite arms (DAS), or spacing of arms of secondary dendrites (SDAS) [23-25]. In case of heat treated aluminum alloys, hardening alloy-forming elements like Cu and Mg do not show any sufficient solubility in solid state; however such solubility decreases as temperature decreases.

The next aspect connected with the solutioning is spheroidizing of precipitations of Si [2,15,16], i.e. change of its morphology affecting on obtained mechanical properties [2,14,26]. In result of heating operation of the silumins, not only increase of concentration in solid solution of elements being potential source of precipitation processes (Cu and/or Mg) can occur, but also change of morphology of eutectic silicon crystals can occur – their coalescence and spheroidizing [2]. Owing to this, the material as a whole does not show any worsening of plastic properties, in spite of hardening of solid solution due to later ageing of the castings [2,27,28].

The present study concerns assessment of an effectiveness of performed T6 heat treatment, characterized by suitably selected ranges of solutioning operation parameters in aspect of obtained tensile strength  $R_m$  of same selected hypo-eutectoid silumins.

## 2. Experimental methods

Owing to addition of silicon, the investigated casting alloys (AlSi7Mg, AlSi7Cu3Mg and AlSi9Cu3(Fe)) feature good casting ability and abrasion resistance, as the silicon has effect on their improvement. These alloys can be poured both into sand moulds

and permanent moulds, as well as can be used in pressure die casting, and in a new technologies like thixocasting and squeeze casting [29-31]. These alloys are characterized by a high strength, are heat treatable (dispersion hardening) and easily welded. Among disadvantages of such alloys are: red brittleness, low plasticity and decreased corrosion resistance. Such alloys are used, among others, to production of cylinder head castings, engine crankcases, water cooled cylinder blocks, components of aviation pumps, car wheel rims, etc.

Investigated alloys were melted in electric furnace at temperature 720-760 °C, and next, refined with Rafal 1 preparation (0,4% mass of metallic charge) and modified with master alloy AlSr10 (0,5-0,6 % mass of the charge). Compliance of chemical constitution of the investigated alloys with the PN EN 1760 standard was confirmed with use of spectrometer of GDS 850A type. Metallic moulds (Fig. 1) were poured with the alloys to obtain the castings, which in the next succession were used (after the treatment) to production of the test pieces. The moulds, prior to the pouring, were heated to 220-250 °C, and next, such temperature was kept during process of pouring into moulds.

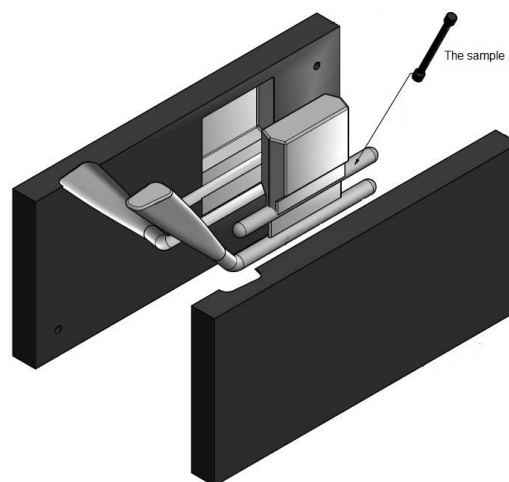

Fig. 1. Metal mould to pouring of the test pieces

To evaluate temperature ranges of the solutioning and ageing treatments of the investigated alloy, it has been implemented the Thermal-Derivative Analysis (TDA), such method is used to record and analyze of course of crystallization process [32-35].

In the Figures 2-4 hereinafter are presented registered diagrams from the TDA method with ranges of solutioning temperature of the investigated alloys.

Use of the ATD method has allowed to evaluate maximal temperatures of solutioning treatment not resulting in partial melting of the alloy (point B - Fig. 2-4) and minimal temperatures connected with thermal effects generated by low alloyed phases rich in Cu and Mg (point A - Fig. 2-4).

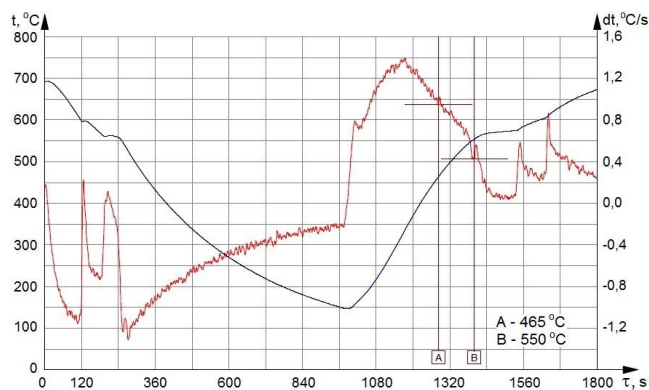

Fig. 2. Diagram of the TDA method of the AlSi7Mg alloy

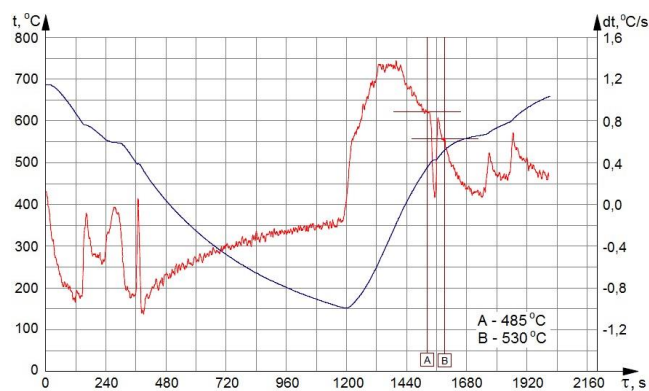

Fig 3. Diagrams from the TDA method of the AlSi7Cu3Mg alloy

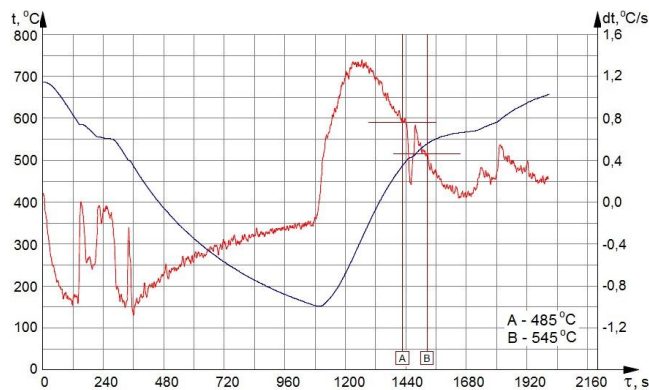

Fig. 4. Diagrams from the TDA method of the AlSi9Cu3(Fe) alloy

In the table 1 are presented ranges of the heat treatment parameters of the investigated alloys.

Table 1.  
Parametry obróbki cieplnej stopów

Alloy	Solutioning temp., °C	Solutioning time, min.	Ageing temp., °C	Ageing time, h
AlSi7Mg	465 - 550		165 - 325	
AlSi7Cu3Mg	485 - 530	30 - 180	175 - 320	2 - 8
AlSi9Cu3(Fe)	485 - 545			

The samples were solutioned in cold water (20 °C). After performed artificial ageing, the test pieces were prepared according to PN-EN ISO 6892-1:2010P standard (measuring length 50 mm, diameter 10 mm). Static tensile strength test was performed on the ZD-20 testing machine. Obtained results were processed with use of StatSoft Statistica ver. 13 software package.

### 3. Research results and analysis

#### 3.1. AlSi7Mg alloy

The alloy without the heat treatment was characterized by tensile strength  $R_m$  at the level 200 MPa, whereas the heat treatment resulted in change of the tensile strength, which was included within range 154 - 335 MPa. In the Figure 5 is presented, in form of spatial diagrams, effect of temperature and time of the solutioning and ageing operations on the tensile strength  $R_m$ , at assumed constant values of ageing temperature 165 °C and ageing time 5 hours (for the solutioning Fig. 5a) and solutioning temperature 520 °C and ageing time 1 hour (for the ageing - Fig. 5b).

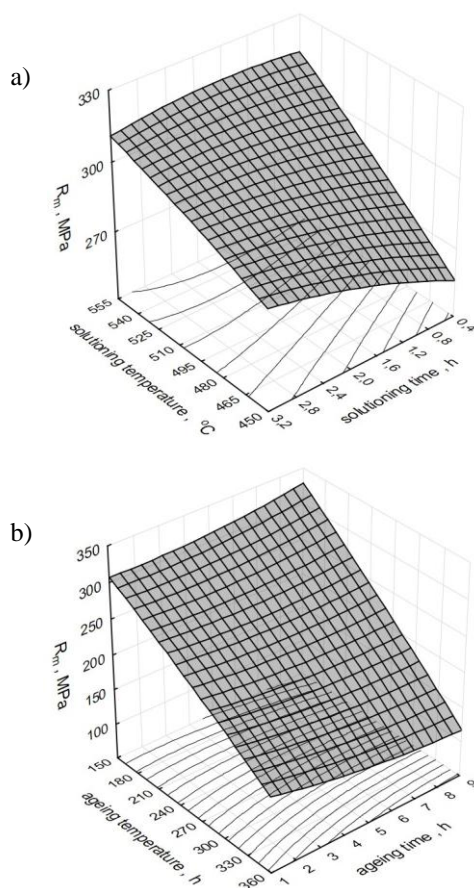

Fig. 5. Change of the  $R_m$  strength of the AlSi7Mg alloy in function of time and temperature a) solutioning, b) ageing

The highest increase in tensile strength  $R_m$  (335 MPa) was obtained for solutioning temperature of 520 °C; holding at such temperature for 30 minutes (ageing temperature - 165 °C and ageing time - 8 hours). Solutioning at temperature 520 °C for 90 minutes (ageing temperature - 165 °C; ageing time - 5 hours) enabled to obtain  $R_m = 305$  MPa. Pio [36] after solutioning at temperature higher with 20 °C for 6 hours (ageing at temperature 160 °C for 6 hours) had obtained  $R_m = 253,5$  MPa. Decrease of ageing temperature to level of 150 °C and shortening of ageing time to 4 hours, as performed by Pedersen [37], had resulted in increase of the  $R_m$  to the level of 270 MPa, whereas extension of ageing temperature to 230 °C and prolongation of its time to 8 hours resulted in further decrease of the  $R_m$  to 210 MPa [38]. Solutioning at temperature 550 °C for 30 minutes (ageing temperature - 165 °C; ageing time - 5 hours) had enabled obtaining  $R_m$  value within limits 315 MPa. Peng in the study [39] had obtained  $R_m = 247$  MPa, after solutioning during 2 hours in the same temperature, and two-hour ageing at 170 °C, what was equal to 95% of the strength as obtained in case of two times longer solutioning and ageing operation during 15 hours.

### 3.2. AlSi7Cu3Mg alloy

The alloy without the heat treatment was characterized by the tensile strength at the level 194-205 MPa.

The heat treatment has allowed for obtainment of the  $R_m$  in broad range from 158 to 368 MPa.

In the Figure 6 is depicted how the tensile strength  $R_m$  is changing depending on temperature and time of solutioning and ageing operations, with fixed at constant level temperature of ageing (175 °C) and ageing time of 5 hours (for the solutioning - Fig. 6a), and solutioning temperature of 500 °C and solutioning time of 1 hour (for the ageing - Fig. 6b).

The highest increase in the tensile strength  $R_m$  (368 MPa) has been obtained after solutioning at temperature 485 °C for 90 minutes (ageing temperature 175 °C; ageing time 8 hours). Prolongation of solutioning time to 3 hours (ageing temperature 175 °C; ageing time 5 hours) enabled to obtain  $R_m = 365$  MPa. Grosselle et. al. [40] applying solutioning temperature lower with 5 °C and solutioning time shorter with 1 hour had obtained  $R_m$  at the level of 289-309 MPa; after ageing at 220 °C of the alloy used typically for treatment of engine blocks [41]. However, initial globular structure of the alloy obtained from rheocast process enabled reduction of solutioning temperature to 470 °C [42] with maintained tensile strength  $R_m$  at the level of 350 MPa. The same strength was obtained in course of the investigations, making solutioning treatment of the alloy at temperature 510 °C in time of 1,5 hour, and next, ageing at temperature 175 °C for 5 hours.

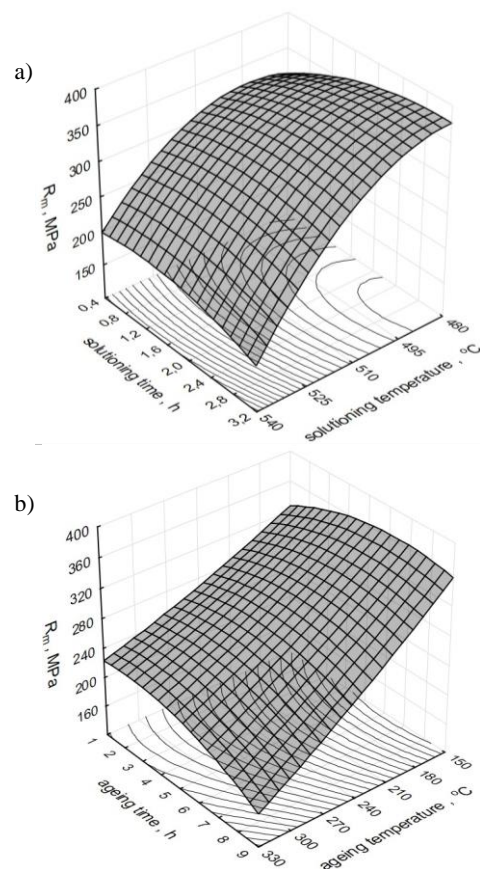

Fig. 6. Change in the  $R_m$  strength of the AlSi7Cu3Mg alloy in function of temperature and time: a) solutioning, b) ageing

### 3.3. AlSi9Cu3(Fe) alloy

Tensile strength  $R_m$  without the heat treatment after modifications amounted to 250-260 MPa. Performed heat treatment has allowed for obtainment of the tensile strength  $R_m$  within range from 145 to 408 MPa.

In the Fig. 7 is presented how the tensile strength  $R_m$  is changing depending on temperature and time of solutioning and ageing operations, with fixed at constant level temperature of ageing (175 °C) and ageing time of 5 hours (for the solutioning - Fig. 7a) and solutioning temperature 500 °C and solutioning time of 1 hour (for the solutioning - Fig. 7b).

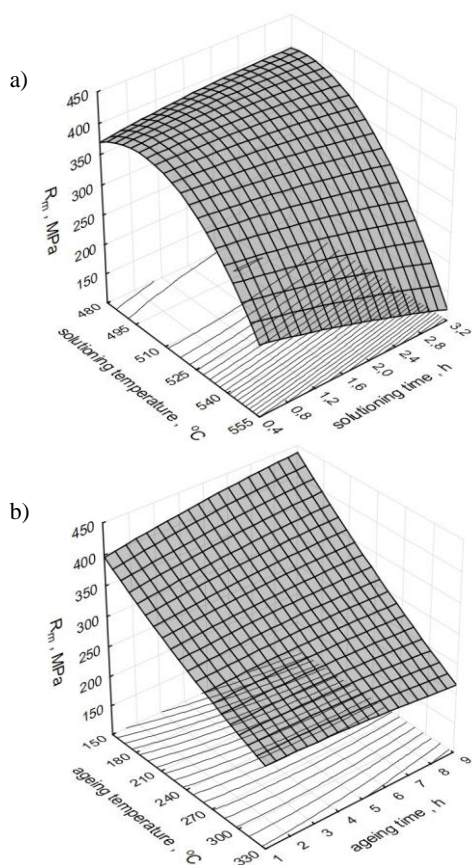

Fig. 7. Change in the strength  $R_m$  of the AlSi9Cu3(Fe) alloy in function of temperature and time: a) solutioning, b) ageing

Making comparison of the tensile strength  $R_m$  values of the alloy before and after the heat treatment, the highest increase in the strength ( $R_m = 408$  MPa) has been observed after soaking it for 1.5 hour at temperature  $485$  °C and ageing for 8 hours at  $175$  °C. Prolongation of solutioning time up to 3 hours, with simultaneous reduction of ageing time to 5 hours had resulted in reduction of the  $R_m$  to the level of 400 MPa. Fan [43], increasing temperature of solutioning to  $500$  °C and solutioning time to 8 hours, and performing ageing operation of the alloy in the time shorter with 1 hour at a similar temperature ( $150$  °C), had obtained value of the  $R_m$  lower with 130 MPa.

Applying solutioning temperature  $510$  °C and performing solutioning of the alloy for 1,5 hour (ageing at  $175$  °C for 5 hours) it has been obtained  $R_m = 406$  MPa. A slightly lower tensile strength  $R_m$  equal to 398 MPa was obtained after further limitation of solutioning time to 30 minutes; with simultaneous prolongation of ageing time to 8 hours. Prolongation of solutioning time at the same temperature (ageing temperature  $225$  °C, ageing time 6 hours) had allowed Molina [44] to obtain  $R_m = 270$  MPa. Only 4 MPa more was obtained by Zolotarevsky [45] by increasing solutioning temperature to  $515$  °C (solutioning time 5-7 hours, ageing for 2-4 hours at  $200$  °C), whilst Hortalova [46] performing solutioning of the same alloy at temperature  $505$ - $515$  °C for 4-8 hours (ageing: 16 hours at  $170$  °C) had increased its  $R_m$  to 311 MPa.

## 4. Conclusions

Obtained results of the study are pointing at existing possibility of limitation of the solutioning parameters, maintaining high values of mechanical properties of hypo-eutectoid alloys from 3xx.x series. Solutioning of the AlSi7Mg alloy at temperatures  $520$  and  $550$  °C for 30 and 90 minutes has enabled to obtain maximal values of the  $R_m$ . In case of these alloys (AlSi7Cu3Mg and AlSi9Cu3(Fe) brands), these temperatures - due to a higher content of Cu - were lower and were equal to  $485$  and  $510$  °C when solutioning time amounted to 90 minutes.

In this case, additive of Cu at the level of 3% enables to obtain, after the heat treatment, maximal values of the  $R_m$  higher with 10-30%.

However, it must be very clearly underlined that it is important to take the process into considerations as a whole, i.e. also considering parameters of ageing operation, having effect on obtained results.

## References

- [1] Pietrowski, S. (2001). *Silumins*. Łódź: Technical University Editorial. (in Polish).
- [2] Poniewierski, Z. (1989). *Crystallization, structure and properties of silumins*. Warszawa: WNT. (in Polish).
- [3] Wasilewski, P. (1993). *Silumins - Modification and its impact on structure and properties*. Katowice: PAN Solidification of metals and alloys. 21, Monography. (in Polish).
- [4] Alshmiri, F. (2013). Lightweight Material: aluminium high silicon alloys in the automotive industry. *Advanced Materials Research*. 774-776, 1271-1276. DOI:10.4028/www.scientific.net/AMR.774-776.1271.
- [5] Padmanaban, D.A. & Kurien, G. (2012). Silumins: the automotive alloys. *Advanced Materials & Processes*, 170(3), 28-30.
- [6] Kaufman, J.G. & Rooy, E.L. (2004). *Aluminum alloys casting: casting properties, processes, and application*. ASM International, Materials Park, OH.
- [7] Tupaj, M., Orłowicz, A.W., Mróz, M. & Trytek, A. (2015). Fatigue properties of AlSi7Mg alloy with diversified microstructure. *Archives of Foundry Engineering*. 15(3). 87-90.
- [8] Gauthier, J., Louchez, P. & Samuel, F.H. (1995). Heat treatment of 319.2 Al automotive alloy: Part 1, solution heat treatment. *Cast Metals*. 8(1995)1, 91-106.
- [9] Tash, M., Samuel, F.H., Mucciardi, F. & Dothy H.W. (2007). Effect of metallurgical parameters on the hardness and microstructural characterization of as-cast and heat-treated 356 and 319 aluminum alloys. *Materials Science and Engineering A*, 443(2007), 185-201. DOI: 10.1016/j.msea.2006.08.054.
- [10] Sjölander, E. & Seifeddine, S. (2012). The influence of natural ageing on the artificial ageing response of Al-Si-Cu-Mg casting alloys. *La Metallurgia Italiana*. 11-12, 39-43.
- [11] Mohamed, A.M.A. & Samuel, F.H. (2012). A Review on the Heat treatment of Al-Si-Cu/Mg casting alloys. *Heat*

- Treatment - Conventional and Novel Applications*, F. Czerwinski (Ed.), InTech, 55-72.
- [12] Sjölander, E. & Seifeddine, S. (2010). The heat treatment of Al-Si-Cu-Mg casting alloys. *Journal of Materials Processing Technology*. 210, 1249-1259. DOI: 10.1016/j.jmatprotec.2010.03.020.
- [13] Sigworth, G.K., Howell, J., Rios, O. & Kaufman, M.J. (2006). Heat treatment of natural aging aluminum casting alloys. *International Journal of Cast Metals Research*. 19(2), 123-129.
- [14] Beroual, S., Boumerzoug, Z., Paillard, P. & Borjon-Piron, Y. (2019). Effects of heat treatment and addition of small amounts of Cu and Mg on the microstructure and mechanical properties of Al-Si-Cu and Al-Si-Mg cast alloys. *Journal of Alloys and Compounds*. 784, 1026-1035. DOI:10.1016/j.jallcom.2018.12.365.
- [15] Furuta, S., Kobayashi, M., Uesugi, K., Takeuchi, A., Aoba, T. & Miura, H. (2018). Observation of morphology changes of fine eutectic si phase in Al-10%Si cast alloy during heat treatment by synchrotron radiation nanotomography. *Materials*. 11(8), 1308. DOI: 10.3390/ma11081308.
- [16] El Sebaie, O., Samuel, F.H., Samuel, A.M. & Doty, H.W. (2008). The effects of mischmetal, cooling rate and heat treatment on the eutectic Si particle characteristics of A319.1, A356.2 and A413.1 Al-Si casting alloys. *Materials and Engineering A*. 480, 342-355. DOI:10.1016/j.msea.2007.07.039.
- [17] Sankar, V. & Muthu, S. (2014). Investigation of microstructure and mechanical behavior of AlSi7Mg. *Journal of Applied Sciences*. 14(8), 811-816. DOI: 10.3923/jas.2014.811.816.
- [18] Apelian, D., Shivkumar, S. & Sigworth, G. (1989). Fundamental aspects of heat treatment of cast Al-Si-Mg alloys. *AFS Transactions*. 97, 727-742.
- [19] Zhang, D.L. & Zheng, L. (1996). The quench sensitivity of cast Al-7 Wt Pct Si-0.4 Wt Pct Mg alloy. *Metallurgical and Materials Transactions A*, 27(12), 3983-3991.
- [20] Xiao, B., Rong, Y. & Li, K. (2011). Experimental investigation of residual stresses in water and air quenched aluminum alloy castings. *Experimental and Applied Mechanics*. 6, 193-199. DOI: 10.1007/978-1-4419-9792-0\_36.
- [21] Ragab, K.A., Samuel, A.M., Al-Ahmari, A.M.A. et al. (2013). Influence of fluidized bed quenching on the mechanical properties and quality index of T6 tempered B319.2-type aluminum alloys. *Journal of Materials Engineering and Performance*. 22(11), 3476-3489. DOI: 10.1007/s11665-013-0610-3.
- [22] Senatorova, O.G. & et al. (2002). Low distortion quenching of aluminum alloys in polymer medium. *Materials Science Forum*. 396-402, 1659-1664.
- [23] Magno, I.A.B & et al. (2017). Effect of the T6 heat treatment on microhardness of a directionally solidified aluminum-based 319 alloy. *Materials Research*. 20(Suppl. 2), 662-666. DOI: 10.1590/1980-5373-mr-2016-0961.
- [24] Barros A.S. & et al. (2015). Measurements of microhardness during transient horizontal directional solidification of Al-Rich Al-Cu alloys: Effect of thermal parameters, primary dendrite arm spacing and Al<sub>2</sub>Cu intermetallic phase. *Metals and Materials International*. 21(3), 429-439. DOI: 10.1007/s12540-015-4499-2.
- [25] Reis, B.P. et al. (2013). The effects of dendritic arm spacing (as-cast) and aging time (solution heat-treated) of Al-Cu alloy on hardness. *Journal of Alloys and Compounds*. 549, 324-335. DOI: 10.1016/j.jallcom.2012.09.041.
- [26] Jarco, A & Pezda, J. (2015). Impact of various types of heat treatment on mechanical properties of the EN AC-ALSi6Cu4 alloy. *Archives of Foundry Engineering*. 15(spec.2), 35-38.
- [27] Skocovský, P., Tillová, E. & Belan, J. (2009). Influence of technological factors on eutectic silicon morphology in Al-Si alloys. *Archives of Foundry Engineering*. 9(2), 169-172.
- [28] Paramo, V., Colas, R., Velasco, E. & Valtierra, S. (2000). Spheroidization of the Al-Si eutectic in a cast aluminum alloy. *Journal of Materials Engineering and Performance*. 9(6), 616-622.
- [29] Brown, Z., Barnes, C., Bigelow, J. & Dodd, P. (2009). Squeeze cast automotive applications and design considerations. *La Metallurgia Italiana*. 3, 2-4.
- [30] Dulyaphant, D & et al. (2013). Applications of squeeze casting for automobile parts. *Materials Science Forum*. 773-774, 887-893. DOI: 10.4028/www.scientific.net/MSF.773-774.887.
- [31] Salleh, M.S., Omar, M.Z., Syarif, J. & Mohammed, M.N. (2013). An overview of semisolid processing of aluminium alloys. *ISRN Materials Science*. 2013, 1-9. DOI: 10.1155/2013/679820.
- [32] Szymczak, T., Gumienny, G. & Pacyniak, T. (2015). Effect of vanadium and molybdenum on the crystallization, microstructure and properties of hypoeutectic silumin. *Archives of Foundry Engineering*. 15(4), 81-86. DOI: 10.1515/afe-2015-0084.
- [33] Pezda, J. (2015). Effect of the T6 heat treatment on change of mechanical properties of the AlSi12CuNiMg alloy modified with strontium. *Archives of Metallurgy and Materials*. 60(2), 627-632.
- [34] Piatkowski, J. & Wieszala, E. (2019). Crystallization and structure of AlSi10Mg0.5Mn0.5 alloy with dispersion strengthening with Al-Fe<sub>x</sub>Al<sub>y</sub>-SiC phases. *Metals*. 9(8), 1-8. DOI:10.3390/met9080865.
- [35] Jarco, A. & Pezda, J. (2016). Effect of different variants of heat treatment on mechanical properties of the AlSi17CuNiMg alloy. *Archives of Foundry Engineering*. 16(2), 41-44. DOI: 10.1515/afe-2016-0023.
- [36] Pio, L.Y. (2011). Effect of T6 Heat Treatment on the Mechanical Properties of Gravity Die Cast A356 Aluminium Alloy. *Journal of Applied Sciences*, 11(11), 2048-2052. DOI: 10.1016/S1003-6326(11)60955-2.
- [37] Pedersen, L. & Arnberg, L. (2001). The effect of solution heat treatment and quenching rates on mechanical properties and microstructures in AlSiMg foundry alloys. *Metallurgical and Materials Transactions A*, 32, 525-532. DOI: 10.1007/s11661-001-0069-y.
- [38] Lech, Z., Dudek, P. & Sęk-Sas, G. (1998). *Instructions for melting non-ferrous metal alloys*. Kraków: Instytut Odlewnictwa. (in Polish).
- [39] Peng, J., Tang, X., He, J. & Xu, D. (2011). Effect of heat treatment on microstructure and tensile properties of A356

- alloys. *Transactions of Nonferrous Metals Society of China*, 21(9), 1950-1956. DOI: 10.1016/S1003-6326(11)60955-2.
- [40] Grosselle, F., Timelli, G. & Bonollo, F. (2010). Doe applied to microstructural and mechanical properties of Al-Si-Cu-Mg casting alloys for automotive applications. *Materials Science and Engineering A*, 527, 3536-3545. DOI: 10.1016/j.msea.2010.02.029.
- [41] Moizumi, K. Mine, K., Tezuka, H. & Sato, T. (2002). Influence of precipitate microstructures on thermal fatigue properties of Al-Si-Mg cast alloys. *Material Science Forum*, 396-402, 1371-1376. DOI: 10.4028/www.scientific.net/MSF.396-402.1371.
- [42] Timelli, G at al. (2014). Sviluppo di trattamenti termici T6 e T7 di leghe secondarie AlSi9Cu3(Fe) e AlSi7Cu3Mg. ASSOFOND XXXII Congresso di Fonderia. 21-22 November, Brescia, Italy.
- [43] Fan, K.F. et al. (2013). Tensile and fatigue properties of gravity casting aluminum alloys for engine cylinder heads. *Materials Science and Engineering A*, 586(1), 78-85. DOI: 10.1016/j.msea.2013.08.016.
- [44] Molina, R. & Rosso, R. (2011). Mechanical characterization of aluminium alloys for high temperature applications Part1: Al-Si-Cu alloys. *Metallurgical Science and Technology*, 29(1), 5-15.
- [45] Zolotarevsky, V.S., Belov, N.A. & Glazoff, M.V. (2007). *Casting Aluminum Alloys*. Elsevier, Oxford.
- [46] Hortalová, L. & Tillová, E. (2010). On the mechanical properties and structure of age-hardened AlSi9Cu3 cast alloy. *International Journal of Applied Mechanics and Engineering*, 15(2), 355-362.