

# Smart Buildings in Italy, some BIM designed examples

## Abstract

The real value of BIM, as a method, is partially undiscovered and require deeper understanding of what real potentialities are and how to take advantage of them in the professional activities. More than ever before the collaboration between engineers, architects and technicians is promoted thanks to BIM. On top of this, the construction industry has realized that the main weakness for decades were the lack of effective communication through reliable and timely channels. Naming BIM, the entire design process should be revised, because we should finally accept that the cooperation, communications and sharing are the seminal elements of the success. This paper, starting with these premise, will present and analyze some good examples of BIM designed projects realised recently in Italy, as the Unicredit Pavilion in Milan by Architetto Michele De Lucchi and the Forti HQ in Pisa by ATlproject that marge smart building processes with environmental targets and a new vision for the urban fabric quality.

Keywords: BIM, Design Process, Case study, Italy

When dealing with Building Information Modelling, a concept introduced with the birth of the modern computers and machine drawing in the 60's of last Century led by Ivan Sutherland at MIT, we still think about programs that enable us to draw our projects through newer software programs. Furthermore, many of us consider BIM as an innovation that should be used because of the advantages widely publicized in the prospects of the software companies that produce software like Tekla, Archicad or Revit, just to name few.

Perhaps, the real value of BIM, as a method is partially undiscovered and requires deeper understanding of what are its real potentialities and how to take advantage of them in the professional activities.

More than ever before the collaboration between engineers, architects and technicians is promoted thanks to BIM. On top of this, the construction industry has realized that the main weakness for decades has been the lack of effective communication through reliable and timely channels.

Having in mind the Abernathy-Utterback Model for the innovation dynamics, the field of Building Information Modelling is represented in ill. 1 through the characteristic curves of product and process innovation. As we can notice, products as Archicad, Revit and Tekla occupy more than 40% of the software market for computer aided design and they have a well-established user interface which overall maintains the same philosophy embedded in BIM. Since the methodology incorporated in these software is considered stable, we assume that many companies are seeking to innovate in the field of organizational processes that are broadly defined or not defined at all. Past surveys on one of the most developed markets which is the North American one, confirms the abovementioned statement: BIM is considered as a mature methodology to be applied among vast majority of players

in the field of architecture, engineering and constructions.

Jointly to the latter, the Gartner's Hype curve (ill. 2) explains even better in which phase the Building Information Modelling is in respect to the AEC industry expectations translated in visibility on the model. Starting from the CAD in the 80' and the dot-com boom in the beginning of the 2000s, each innovation like BIM follows quiet the same characteristic trajectory described by Gartner after many observations and analyses.

Since BIM adoption in each single country has reached different levels, a summarized consideration of the international AEC field could be done using the hype curve. It holds realities ranging from advanced use in USA (ill. 3), Australia and Hong Kong to basic applications (Germany, France) or almost no-adoption (Italy and Eastern Europe). The reasons for that are, as always, political, cultural and sectorial and should be analysed apart.

Before making an investment in this kind of technology we should know that there is not just a unique piece of software behind the BIM concept. Thus, the entire design process should be revised, because it should be finally accepted that cooperation, communications and sharing are the seminal elements of success. Seeking to obtain all this, a strategy should be identified that further entail broadly our ideas for the future.

The first and most important part of the BIM paradigm is "us", stated as personal skills and

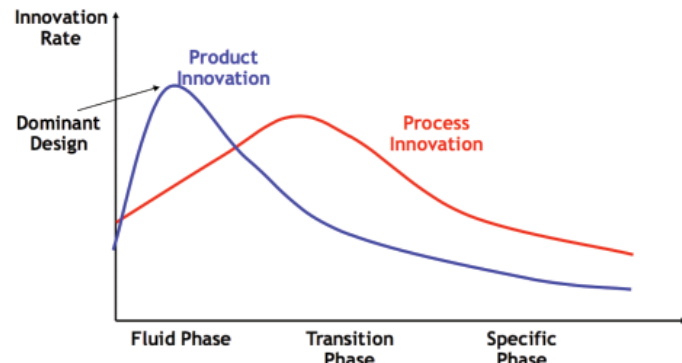

ill. 1. Generic Abernathy-Utterback model for Innovation Dynamics. Credits Adner, R., & Levinthal, D. (2001)



ill. 2: Gartner's Hype Curve of BIM. Re-elaboration by D. Duchev

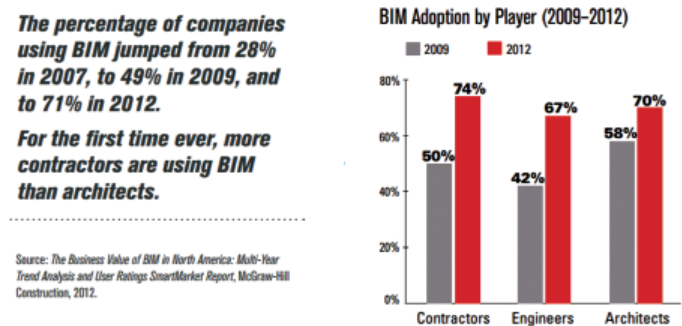

ill. 3: Rate of adoption of BIM in the US AEC sector. Credits MCGraw-Hill Construction, 2012

the willingness to achieve great results with intelligent and state of the art tools that at the same time enhance creativity. We should revise our workstyles, rethinking our relationships as professionals with other professionals and deciding what we want to deliver to our clients and what our customers appreciate the most.

Further, the openness is not a threat. Publishing your plan timely with sufficient details for the right purpose is important for the stakeholders of the project. Someone could argue that in this way the project become an easy candidate to be copied or hijacked. But beside the latter, we should know that some aspects cannot be copied such as talent, internal organizational structure and culture of the design team and the competences that stand behind the project. Drawings are the final manifestation and all the aspects mentioned above remain encrypted into the final project. There is no key for the

external observer through which these artefacts are going to be unlocked.

Second most important pillar we already mentioned is the internal organization and processes in a team or organization. Many times, the work of the architects is thought to be turbulent, full of ambiguities and apparently disordered. One of the crucial elements that we should accept is to work smarter and not harder. We should just leave all prejudices about the profession of the architect (and all the other kind of professionals) and let our minds open, telling ourselves that everything is possible and we just try to build something more efficient like in our dreams. Dare to dream is one of the steps that we should undertake. On other hand, distributing and defining the roles, appointing responsibility to each person, requirements for data drops, deliverables and creation of storage containers, are all administrative and organizational tasks to be defined by the team members or managers. Fortunately, differently from the past, all these tasks have their cyber equivalent living in the digital world and great part of this could be done via the tools offered by BIM and by mainstream ICT. Translating the physical world into a digital one is creating the so-called cyber-physical system, where each complex system that we maintain become even a digital one, with all advantages and disadvantages we can imagine.

Third, before the transfer of even one byte of our work into the new paradigm, we should evaluate professionally and clearly the flaw of competences and what we need to learn before undertaking our new journey towards BIM. Thus, skill endowment of the professionals is much more important than both the software and the organizational scheme. To empower the professionals, strong technological skills should be developed through continuous seminars, workshops that are developed on firm's projects.

Lastly, the program or the set of programs, that support the BIM method should be selected. This selection should consider:

- The characteristics of the computers and availability of funds for upgrades;
- How the organization is built, and what type of professionals reside in it;
- How the present and potential partners of the team are endowed;
- The average complexity of the projects developed by the teams;
- What are the deliverables required by law and by the customers?

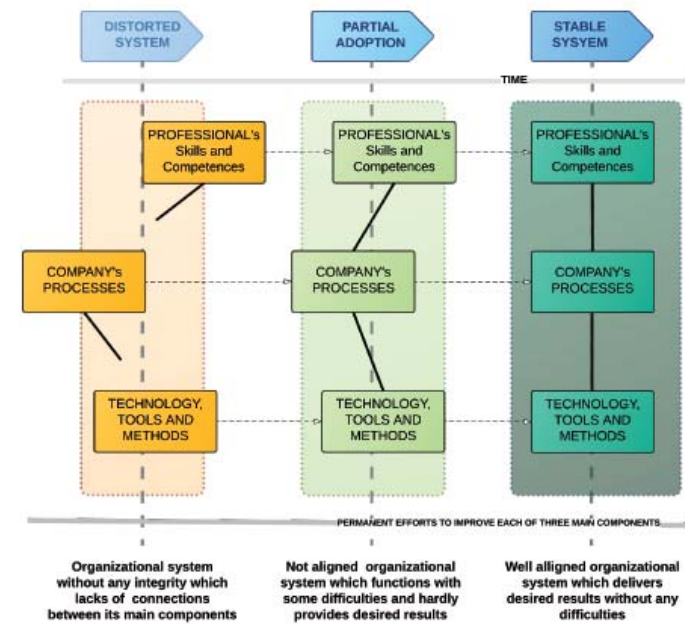

ill. 4: General scheme of Alignment of the three main elements driving BIM. (Elaboration by D. Duchev)

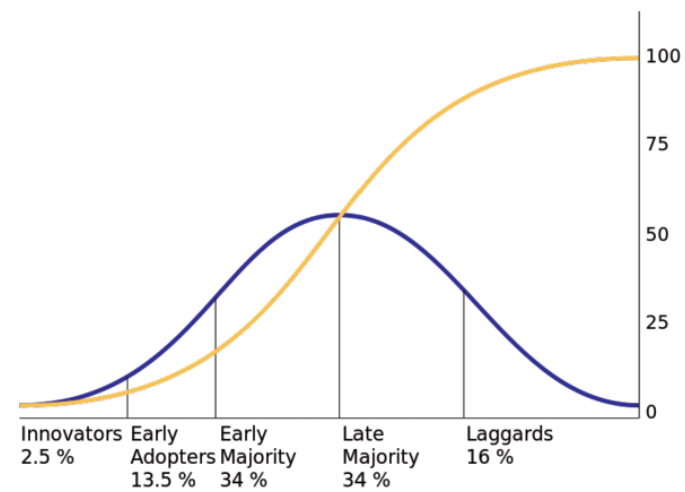

ill. 5: Rogers' curve of adoption of Innovation (distribution in blue and cumulative curve in yellow) presented in 1962. (Credits: Wikipedia Association)

There are different fields in which the outcomes Building Information Model will provide as output, depending on the diverse work-teams. These outputs can be classified according to the following respective disciplines as Urban planning, Structural Design and Engineering, Installations (HVAC, electrical, Plumbing), Architecture, Energy Management and Energy Efficiency, Life Cycle Assessment, Life Cycle Costing, and Adaptive and Dynamic Computational Design.

Furthermore, existing pre-concepts that imply rigid separation of different disciplines are going to be changed adopting this model, thriving for more holistic and comprehensive framework through series of project management approaches managed in integrated and organic way through cooperative and flatter networks of professional subjects acting alone or in formal organizations (ill. 4).

Rate of adoption can be better explained through Roger's adoption curve introduced on ill. 5 which explains how an innovation is adopted in certain customer environment. Here, it can be assumed that the AEC sector is virtually divided into five groups having different propensity to absorb innovation and the Roger's model fits well in this conceptual explanation. At the same time, connected to this, we can apply real empirical example depicted briefly by ill. 6, which practically show what are the benefits for the first two groups defined by Rogers. Thus, both Innovators and Early Adopters gain higher benefits in terms of ROI, having adopted BIM as part of its business. The study presented by McGraw Hill Construction clearly shows that half of the highly-engaged organizations reach a ROI higher than 25%. Afterwards, we can underline that being committed to BIM and having the understanding that it is worth in long term, could generate efficiencies for the organization, supporting at the same time creativity, and increasing customer value. To support the latter, three examples in the building construction and architecture in Italy are presented here.

These three examples provide an insight about how organizations different by structure, size and ownership can interpret and adopt BIM, and which are the functionalities they value most.

ill. 6: ROI related to the level of BIM engagement revealed by a McGraw Hill Construction Survey in 2013

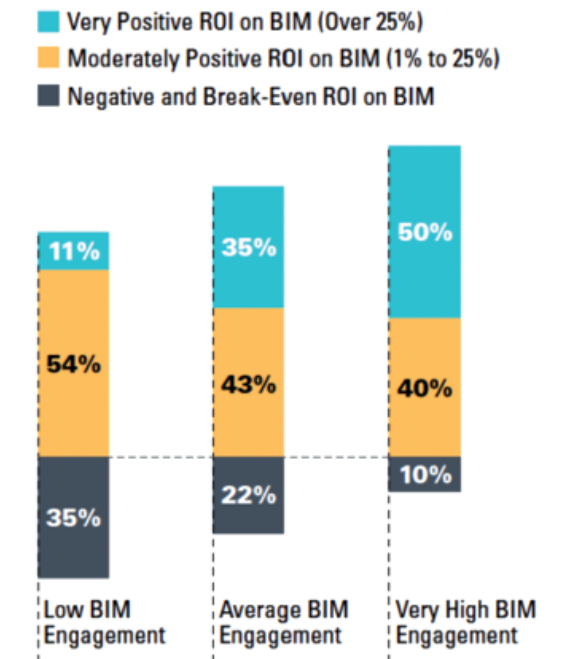

**Unicredit Pavilion (Michele De Lucchi Architects, 2015)**

The Unicredit Pavilion has been built in the heart of one of the latest Milanese urban regeneration plans located in Porta Nuova district nearby the "Vertical Forest" complex, the icon of bioclimatic architecture by Stefano Boeri Associati. As part of Unicredit Bank's identity and as manifestation of the rising attention on urban environment and sustainability, the building encompasses a variety of technologies and approaches that provide together outstanding results helping in this way the increase of the smart-city concept.

Result of an architectural competition organized by the developer Hines with Unicredit Bank and won by the Studio of Michele De Lucchi, Pavilion's construction started in 2013. In the multifunctional building, opened in 2015 in coincidence with the EXPO Milan events, find place a kindergarten, an auditorium and a multipurpose conference hall.



ill. 7: View of the Unicredit Pavilion in the Porta Nuova RE Development. (Credits: Photo by Tom Vack, courtesy MDL Architects)



ill. 8: A sketch of Unicredit Pavilion by Michele De Lucchi. (Credits: Courtesy MDL Architects)

ill. 9: Revit section enriched with artistic representation of the environment. (Credits: Courtesy MDL Architects)



In this project designers wanted to merge both the architectural-artistic expression and technical integrated design, through which goals like natural resources savings, costs and time optimizations during the design phase and the following built-up life cycle, as well as a LEED Gold certification have been achieved. Looking behind the outstanding architectural result reached by this construction, authors would like to mention the approach designers adopted to achieve it.

Chiefly, the design phases have been developed using one of the leading BIM software through which a significant level of integration has been accomplished during the preliminary, definitive and final design, and lastly during the construction phase.

Furthermore, thanks to Building Information Modelling, the specific architectural form and the load bearing structure have been continuously refined simultaneously, considering at the same time the technical equipment and spatial coordination. Moving the project on the Revit platform, the collaborative 3D environment enabled many professionals and consultants to manage architectural, technical and estimation issues in order to be solved jointly. More the use of the Revit model allowed the exchange of always updated information among parties, simplifying and speeding-up the overall process. Ultimately, the BIM platform offered by REVIT software helped contractors and suppliers to deliver seamlessly services and equipment needed for the timely completion of the project.

For example, the roof contractor notably decreased production and installation time of the state-of-the-art rooftop composed by

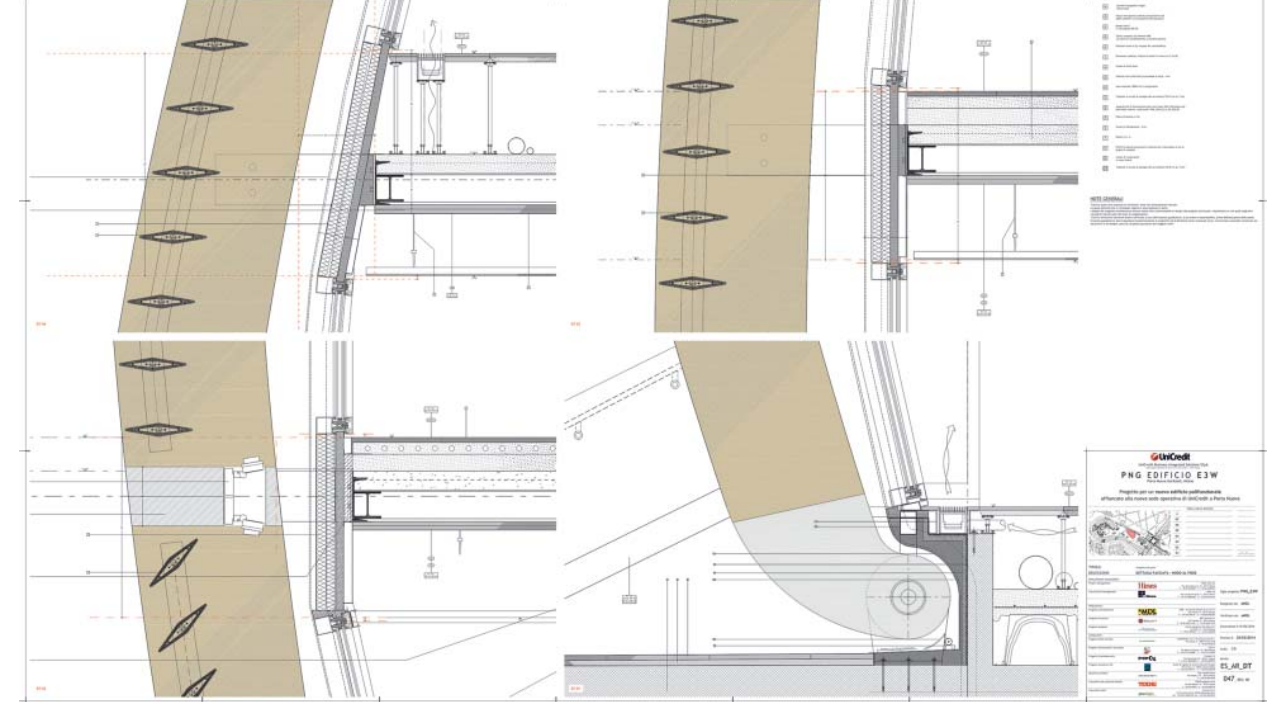

ill. 10: Section of REVIT 3D model representing detail from architectural, load bearing structures. (Credits: Courtesy MDL Architects)

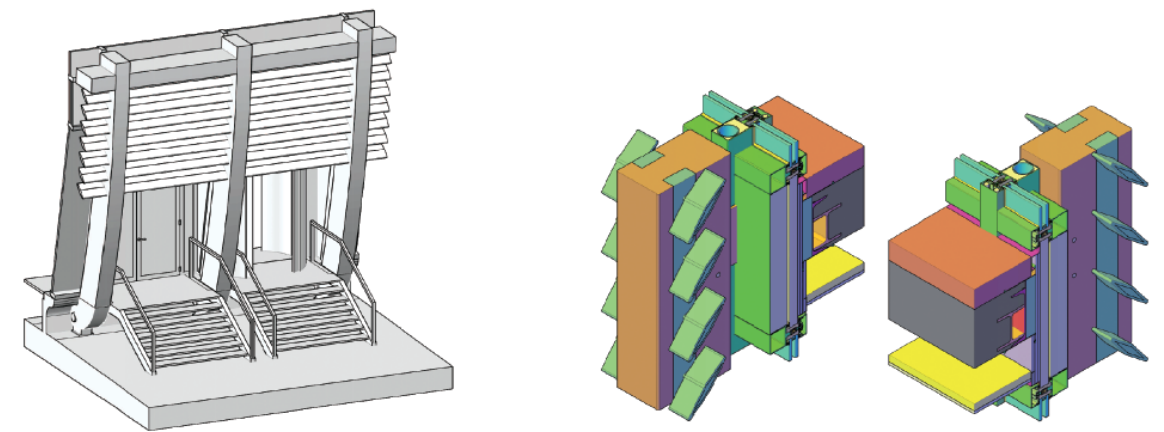

ill. 11: Sections of Revit 3D model of the main entrance and executive drawings of a technological node which join the shading system, the façade and the floor. (Credits: Courtesy MDL Architects)

ill. 12: HVAC systems model (on the left column), load bearing structure (on the right column) and merged model which comprise the architectural model. (Credits: Courtesy MDL Architects)

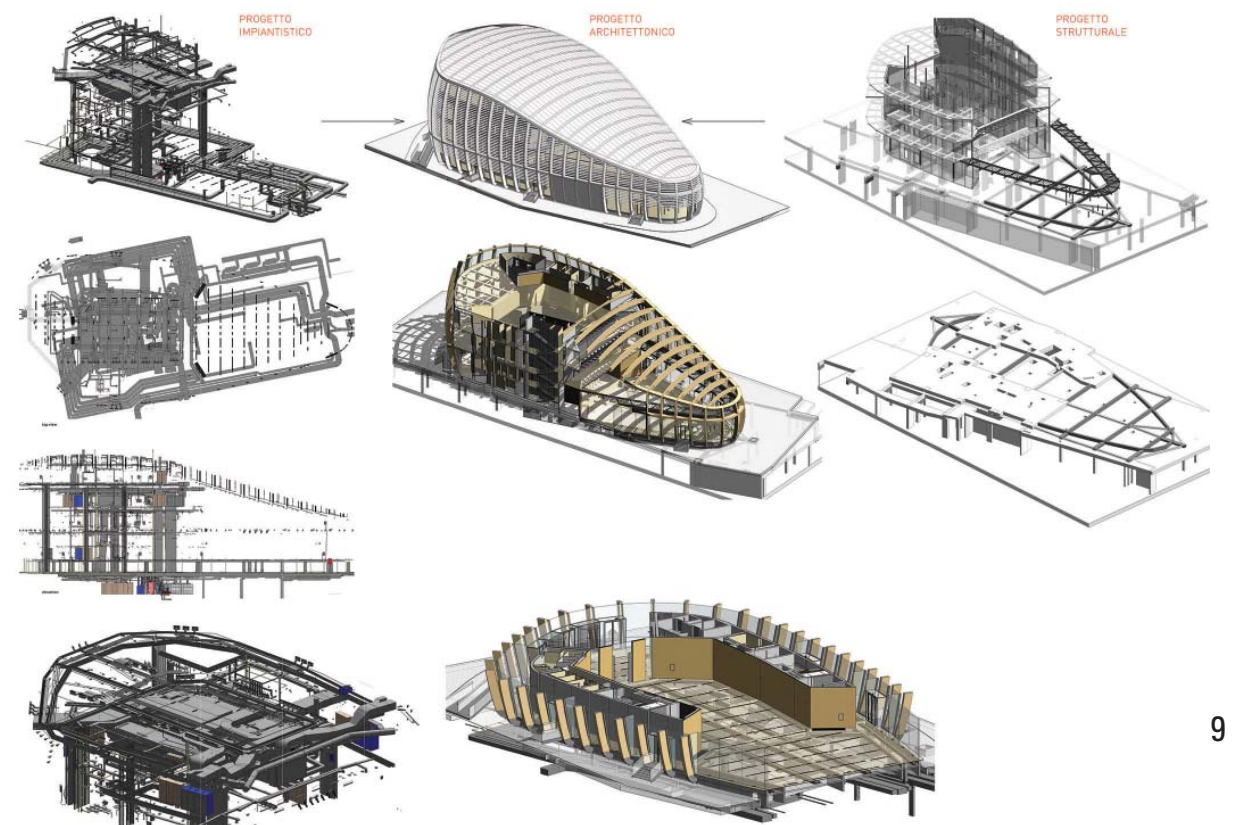

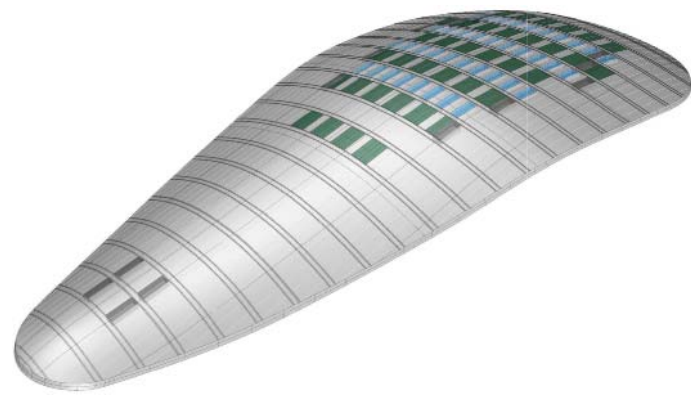

ill. 13: Revit 3D model of the roof with integrated photovoltaic panels and skylight windows. Credits MDL architects

photovoltaic panels, curved metal sheets and integrated roof eaves whose drawings have been obtained directly from the pavilion's BIM model and consequently transferred into the production plan, where they have been accurately manufactured to fit precisely in during the installation phase. Most importantly, the perfect matching between the concrete core structure, the timber frame external structure, and the HVAC plants integrated into the building have been facilitated by the 3D building information shared model. Additionally, all parties involved in this project stated that Building Information Modelling delivered the desired results on time, permitting the opening of the complex in parallel with the EXPO Milan 2015 events and improving on one hand the building process and on other hand the building's overall performance.

#### Milano Strozzi Street Public School (ATIproject, on going)

Looking at Milan as one of the most vital places in Europe, it can be said that the development and improvement of new education facilities is under way. Starting from one of the most advanced universities like Politecnico di Milano, where a Sustainable Campus program is promoted, passing through the state of the art kindergarten embedded in the Unicredit Pavilion, we describe here the project for a public school that has recently received State and Regional funding

ill. 14: Milan Strozzi School model REVIT rendering. (Credits: courtesy ATIproject)



thanks to a requalification and innovation enhancing plan that has the aim to strengthen the sustainable and equitable development of one of the largest metropolitan areas in Italy. The Strozzi Public School is one of them. Once completed, it will meet highest environmental and energy performance standard reaching LEED Platinum standards and will provide flexible and well-designed study spaces.

Architecture Studio ATIproject is the winner of the public bid organized by the City of Milan. The studio provided an integrated design approach through BIM, convinced that this method of design could be the only new way to rethink the approach from larger brown-field recovering projects to a smaller urban requalification scale.

Having started the construction in April 2017, the School has a three-storeys main building which hosts classrooms, a library, and offices, along with a second building dedicated to sport activities, special events and a canteen. Both buildings, made by timber frames, are surrounded by green areas, and a vegetable garden. The Strozzi School is innovative both for its social and educative characteristics and for the environmental targets that would like to accomplish, and has been designed with one of the most innovative BIM tools as Revit. Looking at the ATIproject's design we discover that the bioclimatic approach is accompanying and integrated all along the project phases, merging with all the disciplines as architecture, structural engineering, and HVAC, renewable energy sources plumbing and electrical systems plants.

Furthermore, all these disciplines have given the birth to an integrated and fully functional 3D model full of all relevant data that characterize each single element to be built. For prefabrication process purposes, BIM offers

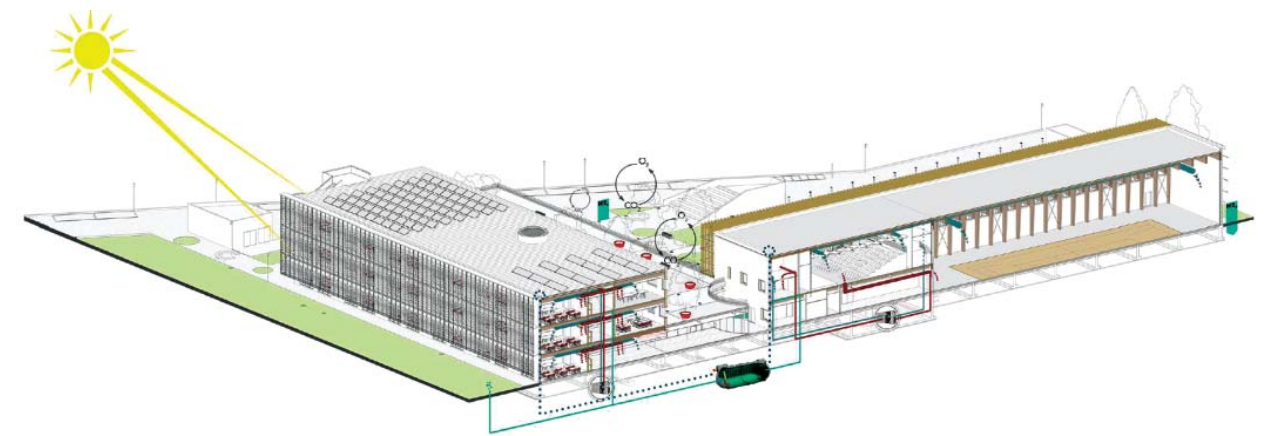

ill. 15: Bioclimatic analysis with the help of Revit 3D model. (Credits: courtesy ATIproject)

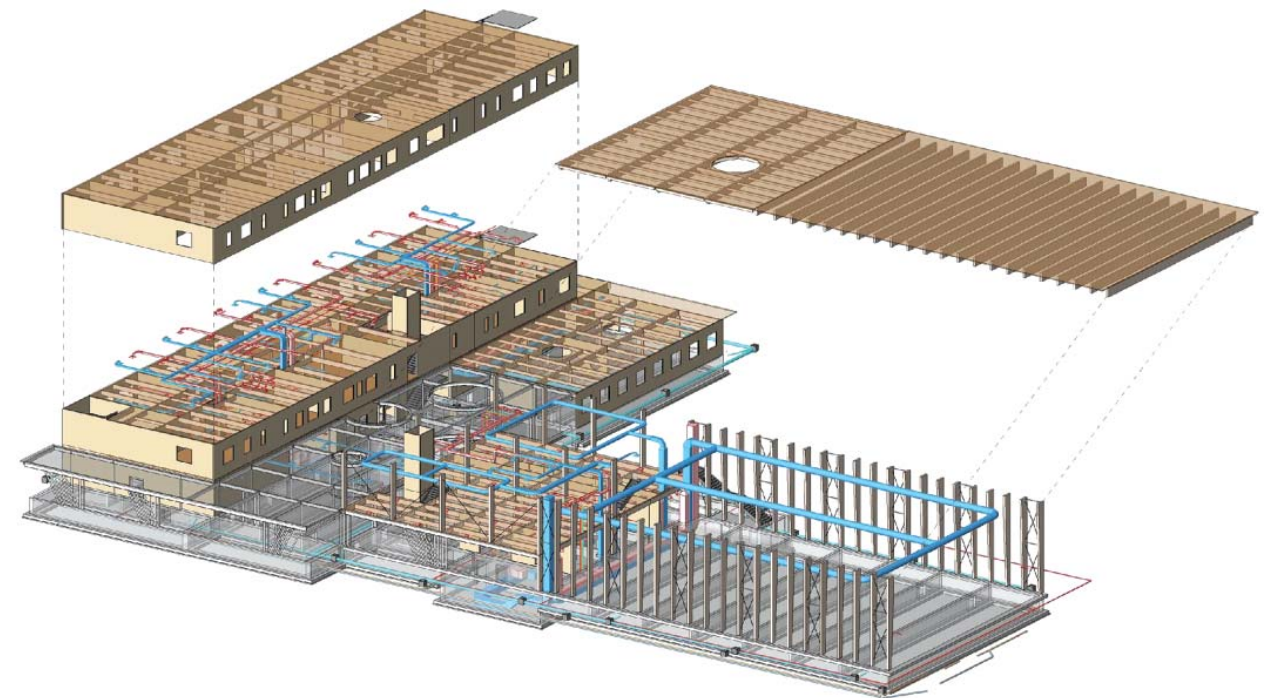

ill. 16: Exploded 3D representation of the prefabricated load bearing Xlam structure, foundations and ventilation structure. (Credits: courtesy ATIproject)

great definition of each construction element, so the prefab procedure is facilitated by the continuous flow of executive drawings useful to the producers of timber beams, columns, partition walls and ducts that have to be manufactured off site. In other words, the prefabrication methods together with this new method of designing provided by an advanced software, jointed to a transparent collaboration philosophy including the participation element, have brought ATIproject to a successful realization, that will increase the value of the town, as a whole.

#### Forti Office building (ATIproject, 2016)

Unlike two previous examples, where big institutional clients lead extensive projects within the urbanized area of Milan, here we present another good example showing how extensive and versatile can be BIM in different environments.

The private company Forti Holding Spa asked in 2013 to ATIproject to design its new headquarter in the rural area of Piza, located in Montacchiello (Pisa Province, Tuscany). The explicit request of the client was to pay great attention to environmental sustainability and the building's energy consumption along with all the other needs related to an office representative building.

Even if both the concrete cast-in-place load bearing structure and the prefabricated steel framing have been managed through traditional design processes, at some point these data have found a common point for exchange between different disciplines using different design tools, supporting in this way the further

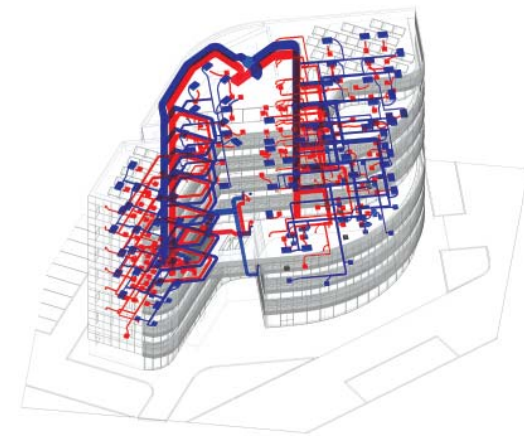

ill. 17: Forti holding headquarter south façade characterized by photovoltaic panels that provide 80% of electric power needs. (Credits: Photo by Irene Taddei, courtesy ATlproject).

ill. 18: Heating and cooling ducts connected to ground thermal pumps modelled with Revit MEP on the base of BIM virtual building. (Credits: courtesy ATlproject)

development of the other sub-routines. How happened in the Strozzi School design, also for this project BIM has been used as a tool through which has been designed the glazing façade and the HVAC system in order to fulfil the client's requests. Notably, the use of BIM helped the designers to determine and simulate the behaviour of the building under different

ill. 19: representation on top of Revit 3D section, of the management of thermal equilibrium of the building during winter. (Credits: courtesy ATlproject)



weather conditions in addition to bioclimatic design of the façade conformation, which increased the efficiency of the engineer's choices, which have been made taking count of all these parameters to obtain an optimal and easier to build up HVAC configuration.

Looking at this 2013 project developed by this young Pisa's company, the implementing of new design tools and methods like BIM appears as a natural flow. In fact, BIM should be adopted gradually, along with the enhancement of the skills and knowledge of the designing team. Lastly, the modularity and the interoperability of BIM tools allow such gradual approaches in the adoption even though the full potentialities of the tool are always available. In fact, such a dynamic can be observed following the application of BIM on these two assignments, one dating 2013 and the other 2016 where ATlproject shows one side to be 'grown-up' capability and on the other how smart cities require well prepared designer and builders that transform concepts into reality.

In the final analysis, all these three Italian examples provide to demonstrate how integrated design system can be applied by different actors in different contexts. It can be said that BIM method covers a broad range of phases (ill. 20) starting from the planning and concept design arriving to the operation and maintenance phases. Providing an overview, there is an evidence that the complexity of use of BIM depends on the development of the

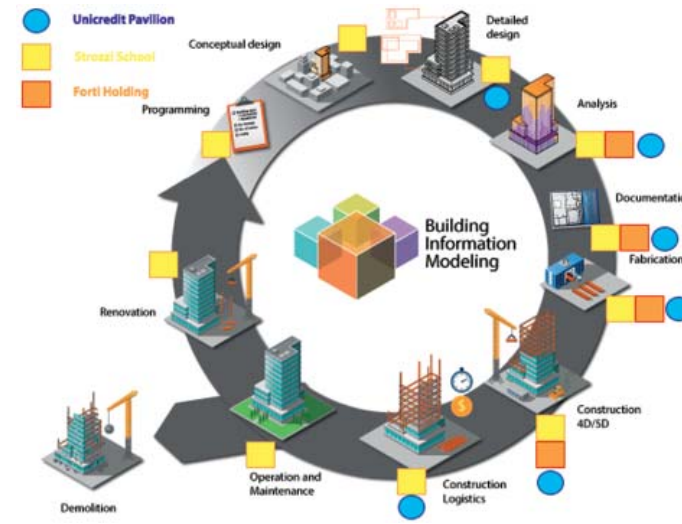

ill. 20: Summary of the presented projects aligned to main phases of the design and construction process. (Elaboration by D. Duchev)

skills, as proved by the two projects of ATlproject, and this comes as a confirmation of the initial thesis presented in ill. 4. In summary, we can confirm that the development of innovative and smart initiatives in the urban environment cannot miss the adoption of new and less explored tools that should be applied wisely and without forgetting to develop the skills of the professionals that should carry on architectural, structural and systems design.

#### BIBLIOGRAPHY

- Barnes P, Davies N, BIM in principle and in practice, ICE publishing, London, UK, 2014.
- Crotty R, The impact of building information modelling: transforming construction, Spon press, New York, USA, 2012.

- Duchev D, Design with BIM and the information systems, Bachelor thesis, University supervisor: Prof. Elisabetta Ginelli, Politecnico di Milano, Milano, IT, 2015
- Garber R, BIM DESIGN. Realising the creative potential of building information modelling, Wiley, Chichester, UK, 2014.

#### PERIODICS

- "World Green Building Trends 2016. Developing Markets accelerate Global Green Growth" in Smart Market Report, Dodge Data&Analytics, Bedford, MA, USA, 2016.
- "The business Value of BIM for Owners" in Smart Market Report, McGraw Hill Construction, Bedford, MA, USA, 2014.
- "The Business Value of BIM for Construction in Major Global Markets" in Smart Market Report, McGraw Hill Construction, Bedford, MA, USA, 2014.