



Experimental Evaluation of Circular Frequency Supply of Radiant Floor Heating System

Tomasz Cholewa, Alicja Siuta-Olcha
Lublin University of Technology

1. Introduction

Nowadays, a lot of attention is paid to the rationalization of energy consumption [1, 3, 10, 11, 13], which is caused, among others, by the deficit of non-renewable raw materials and particularly energy carriers [19, 20].

Therefore the development of new energy sources (especially renewable ones) creates new technical, economic and ecological challenges [2, 7, 12, 16, 17, 22]. Modern heat sources, such as condensing boiler or heat pumps are used more and more often, because of their high energy efficiency. Such a heat source mostly used low temperature radiant floor as heat emitter in the heated room, which is supplied by low-temperature ($t_z < 55^\circ\text{C}$) heating medium. Taking this into account, it may be stated that a lot of research is made to optimize such system [5, 8, 9, 14, 15, 18, 23] during the dimensioning and exploitation phase.

However, there is very few research [4, 6, 21] focusing on the regulation of radiant floor heating system, and the possibilities of achieving energy savings. Moreover, there is still a lack of experimental and numerical research presenting the evaluation of circular frequency supply of massive radiant floor heating system.

Hence, this paper presents experimental research on circular frequency supply of massive radiant floor heating system.

2. Materials and methods

Experimental research on radiant floor heating system in the function of the circular frequency supply was made in the laboratory room (on a semi-technical scale) at the Faculty of Environmental Engineering of the Lublin University of Technology.

The analyzed radiant floor with the area equal to 2.43 m^2 ($1.56 \text{ m} \times 1.56 \text{ m}$) consisted of the following layers (layers counted from below):

- styrofoam (thickness equal $s = 0.06 \text{ m}$, and conductivities $\lambda = 0.045 \text{ Wm}^{-1}\text{K}^{-1}$),
- pipes (PE-RT/Al/PE-RT) with 16×2.0 diameter, and high heat conduction coefficient $\lambda = 0.40 \text{ Wm}^{-1}\text{K}^{-1}$, pipes were arranged with the spacing amounting to 0.15 m ,
- concrete with the plasticizer ($s = 0.065 \text{ m}$, $\lambda = 1.2 \text{ Wm}^{-1}\text{K}^{-1}$),
- ceramic tiles ($s = 0.01 \text{ m}$, $\lambda = 1.05 \text{ Wm}^{-1}\text{K}^{-1}$).

For the purpose of isolating the radiant floor from the environment, it was placed in the climatic chamber ($1.56 \times 1.56 \times 2.21 \text{ m}$) the walls of which were insulated with the 10 cm thick styrofoam. From the inside, the walls of the chamber were painted black and characterized with the constant and well-known emissiveness equal to $\varepsilon = 0.95$. The climatic chamber was situated in the laboratory room in which the indoor temperature was maintained at the constant of 20°C .

In order to evaluate the characteristic thermal parameters of analyzed radiant heating system by circular frequency supply, the following values were measured:

- the temperature of heating medium on supply (t_z) and on return (t_p),
- the flow of heating medium in the system (V),
- the indoor air temperature in the climatic chamber at 110 cm ($t_{a1.1}$),
- temperatures of black globe in the climatic chamber at 110 cm ($t_{g1.1}$),
- the temperature of the surface of radiant floor (t_{s1} - t_{s9}), which was measured by the use of nine sensors situated in the representative area for this radiant floor (Fig. 1),
- heat flux densities (Wm^{-2}), which is emitted from radiant surface.

All temperature sensors were characterized with accuracy to 0.1K .

The system works with a special computer program for monitoring, archiving and data visualization. All parameters are being recorded every 5 minutes.

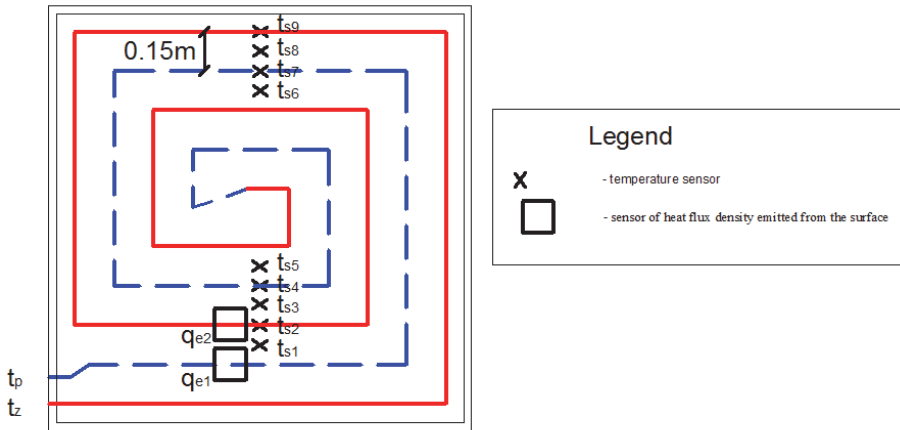

Fig. 1. Schema of location of sensors on radiant floor surface

Rys. 1. Schemat usytuowania czujników na powierzchni grzejnika podłogowego

Research methodology consisted in circular frequency supplying of the analyzed radiant floor with heating medium, the temperature of which on supply was equal to 45°C and the flow of the heating medium was amounted to of 2.2 dm³ per minute.

Experimental research was made for seven cases of the circular frequency supply, which differed in the relation of the period of supply to the period of pause and the length of the given period (Table 1).

Table 1. The characteristic of the analyzed cycles in the circular frequency supply

Tabela 1. Charakterystyka analizowanych cykli ogrzewania pulsacyjnego

ON/OFF	Time		
	15 min	30 min	60 min
1/1	15/15	30/30	60/60
1/2	15/30	30/60	–
1/3	15/60	30/90	–

On the basis of archived measurement, the operative temperature in the exploratory chamber was calculated at 1.1 m using Equation 1.

$$t_o = \frac{t_{a1.1} + t_{mr1.1}}{2} (\text{°C}) \quad (1)$$

where:

$t_{a1.1}$ – indoor air temperature at 1.1 m,

$t_{mr1.1}$ – the average radiation temperature at 1.1 m, which was calculated by use of Equation 2.

$$t_{mr1.1} = (t_g + 273)^4 + 0.4 \cdot 10^8 |t_g - t_{a1.1}|^{0.25} \cdot (t_g - t_{a1.1})^{0.25} - 273 (\text{°C}) \quad (2)$$

where:

t_g – black globe temperature at 1.1 m.

In order to evaluate the energy efficiency of each kind of the regulation, the heat flux densities were specified: the one supplied to heating system (Equation 3) and the one emitted from the radiant surface (q_e), which is the average value from two sensors of heat flux density (q_{e1} , q_{e2} see Figure 1).

$$\dot{q}_s = \frac{\dot{m} \cdot c_w \cdot \Delta t}{F} (\text{W m}^{-2}) \quad (3)$$

where:

\dot{m} – mass flow of heating medium (kg s^{-1}),

c_w – specific heat of heating medium in the given temperature ($\text{J kg}^{-1} \text{K}^{-1}$),

Δt – the average difference of the temperature of heating medium on supply and return from the radiant floor (K),

F – the radiant floor area, $F = 2.43 \text{ m}^2$.

3. Results and discussion

On the basis of experimental research, a considerable decrease of operative temperature was observed for the ON/OFF cycle of 30/90 min, 15/60 min and 60/60 min, while in cycle 30/60 min, 15/30 min, 30/30 min and 15/15 min, the operative temperature fluctuated only to a limited degree, which can be observed in Figure 2 and Figure 3.

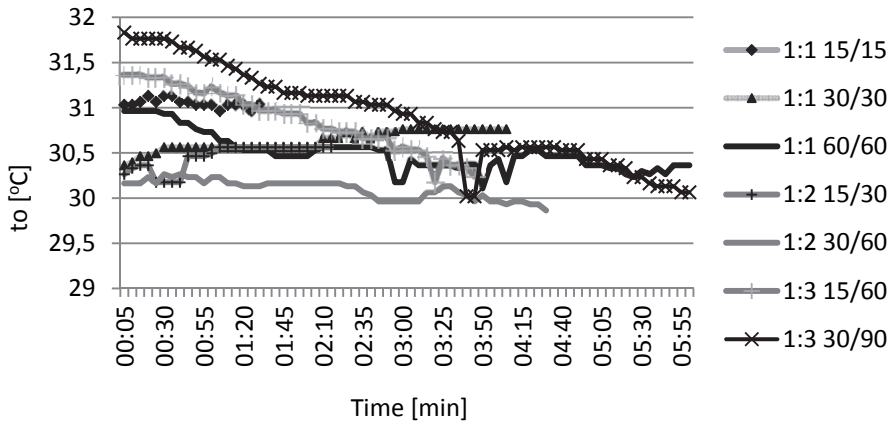

Fig. 2. Operative temperature in the climatic chamber for the analyzed circular frequency supply

Rys. 2. Temperatura operatywna w komorze klimatycznej dla analizowanych opcji zasilania pulsacyjnego

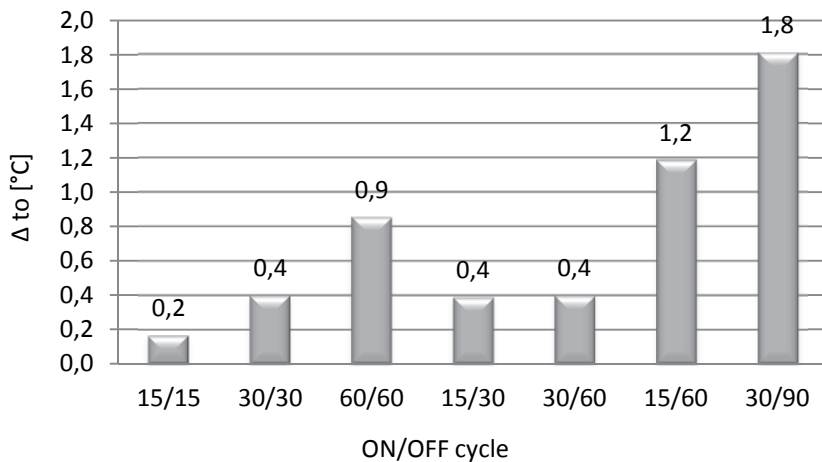

Fig. 3. Fluctuations of operative temperature depending on the cycle of circular frequency supply

Rys. 3. Wahania temperatury operatywnej w zależności od zastosowanego cyklu zasilania pulsacyjnego

Drawing on the data presented in Figure 3 it can be stated that greatest oscillations of operative temperature (1.8°C) were observed in the cycle in which heating was turned off for the longest time (30/90 min). The operative temperature drops considerably due to the long period of pause and when the heating installation is switched back on, it does not return to its previous state. However, for short operation and pause times, such as 15/15 min, the operative temperature is practically on the constant level (0.2°C fluctuations).

While analyzing the heat flux density delivered to the system, it was noticed that the first phase of heating was followed by a significant increase of this value, which then decreased in time (Figure 4). This is connected with greater energy input, which is required to return to the previous state.

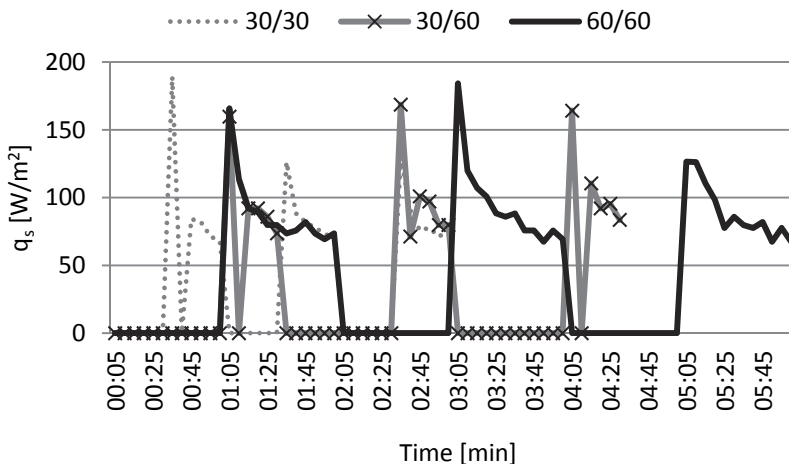

Fig. 4. Densities of heat flux delivered to heating system (q_s)

Rys. 4. Gęstości strumienia ciepła dostarczanego do układu (q_s)

In the case of heat flux emitted from the radiant floor, it decreases temporarily after the pause period, due to the lengthened reaction time of system. Then, it gradually increases (Figure 5). Nevertheless, the heat emitted from the surface in cycles with short period of warming compared to pauses, maintains the general downward trend, because the system cools itself too much during the long period of pause, while the installation works too short to return to its previous state.

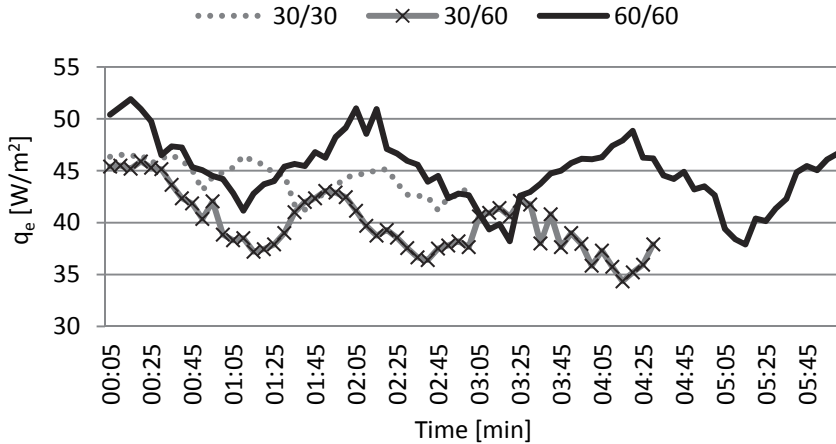

Fig. 5. Densities of heat flux emitted from the radiant floor surface (q_e)

Rys. 5. Gęstości strumienia ciepła przejmowanego z powierzchni grzejnika (q_e)

Therefore, the greatest consumption of the delivered heat was noticed in the cycles which were characterized by the equal durations of heating and pause phases. The greater the disproportion between the working and pause period, the less heat was emitted from the radiant surface to the room (Figure 6).

Moreover, for each circular frequency supply cycle, the amount of delivered and emitted energy for 6 hours of work (Figure 7) was calculated based on received data from three measuring-series. Depending on the ON/OFF cycle, the energy delivered to the system ranges from 0.2 to 0.6 kWh, while the energy emitted from the radiant floor equals between 0.6 and 0.8 kWh.

Hence, in every ON/OFF cycle, the quantity of the energy emitted from the radiant surface exceeds the value of the energy delivered to the heating system.

Therefore, the relation of the emitted energy to the delivered one equals over 100% in every investigated case (Figure 8), which enables energy savings while maintaining the thermal comfort in heated rooms.

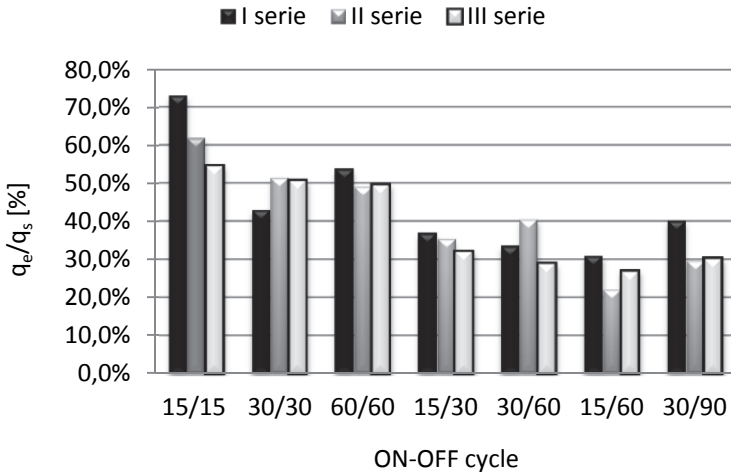

Fig. 6. The relation between the density of heat flux emitted to the room (q_e) to the delivered one (q_s) for analysed ON/OFF cycles

Rys. 6. Stosunek gęstości strumienia ciepła przejmowanego (q_e) do dostarczanego (q_s) dla analizowanych cykli włącz/wyłącz

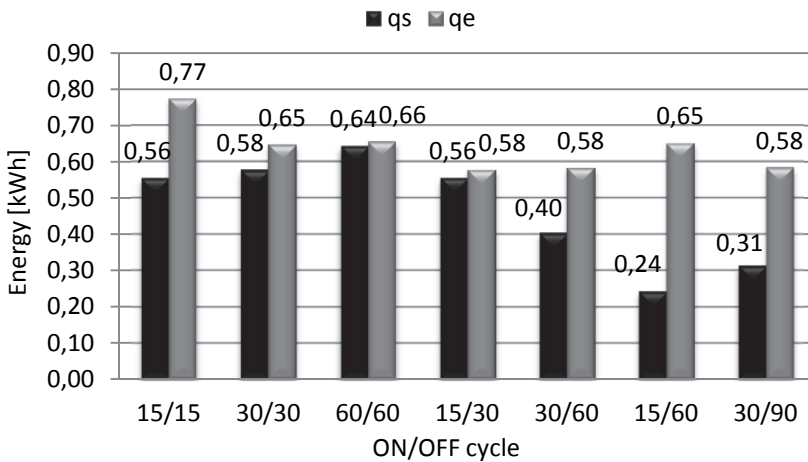

Fig. 7. The energy delivered to the system and emitted from the surface during 6 hours of radiant heating work for the analyzed ON/OFF cycles

Rys. 7. Energia dostarczana i przejmowana w czasie 6 h pracy instalacji ogrzewania podłogowego dla analizowanych cykli ON/OFF

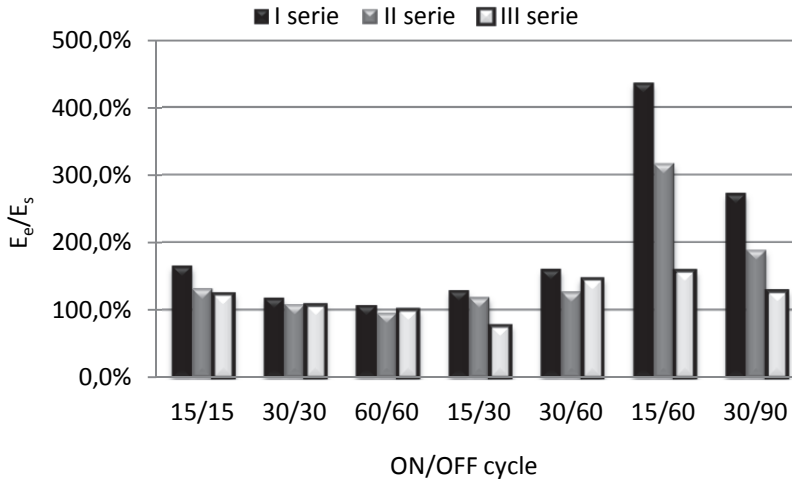

Fig. 8. The relation of the emitted energy (E_e) to delivered energy (E_s) in three measuring series for the analyzed ON/OFF cycles

Rys. 8. Stosunek energii przejmowanej (E_e) do dostarczonej (E_s) w trzech seriach pomiarowych dla analizowanych cykli włącz/wyłącz

4. Conclusions

Experimental research done on the laboratory stand allowed for the evaluation of circular frequency supply of radiant floor heating system in the aspect of the energy saving and maintenance of the thermal comfort.

It was noticed that the greatest fluctuations of operative temperature appeared in the cycle with the longest pause phase. The operative temperature considerably drops due to the long period of pause.

However, in the case of short work and pause periods, such as 15/15 min, the operative temperature is practically on the constant level (oscillations within 0.2°C).

Additionally, it was noticed that in every ON/OFF cycle, the quantity of the energy emitted from the radiant floor is higher than the value of the energy delivered to the system, which enables energy saving. However, changes of thermal comfort parameters in heated rooms which can appear at longer periods of pause should be taken into account.

Acknowledgements

This study was supported by project No. IP2012 007772, financed by the Polish Ministry of Science and Higher Education in years 2013–2015.

References

1. **Cao B., Zhu Y., Li M., Ouyang Q.:** *Individual and district heating: A comparison of residential heating modes with an analysis of adaptive thermal comfort.* Energy and Buildings, 78, 17–24 (2014).
2. **Cao Y., Shan S.:** *Energy Recovery from Sewage Sludge.* Rocznik Ochrona Środowiska (Annual Set the Environment Protection), 14, 81–95 (2012).
3. **Chengmin C., Yufeng Z., Lijun M.:** *Assessment for central heating systems with different heat sources: A case study.* Energy and Buildings, 48, 168–174 (2012).
4. **Cho S.-H., Zaheer-uddin M.:** *An experimental study of multiple parameter switching control for radiant floor heating systems.* Energy, 24, 433–444 (1999)
5. **Cholewa T., Rosiński M., Spik Z., Dudzińska M.R., Siuta-Olcha A.:** *On the heat transfer coefficients between heated/cooled radiant floor and room.* Energy and Buildings, 66, 599–606 (2013).
6. **Cholewa T., Rosinski M., Spik Z., Siuta-Olcha A., Dudzinska M.R.:** *Heat capacity control of floor heating system.* IN Proceedings of 43 International Congress & Exhibition on Heating, Refrigerating and Air-Conditioning, Edited by Branislav Todorovic. Belgrad, Serbia, 5–7 December 2012.
7. **Dąbrowski J., Piecuch T.:** *Mathematical Description of Combustion Process of Selected Groups of Waste.* Rocznik Ochrona Środowiska (Annual Set the Environment Protection), 13, 253–268 (2011).
8. **Dudkiewicz E., Jadwiszczak P., Jeżowiecki J.:** *Examination of operational dynamics of radiant ceiling panel.* Central European Journal of Engineering. 1 (2), 159–167 (2011).
9. **Dudkiewicz E., Fidorów N., Jeżowiecki J.:** *Analiza zużycia energii dla grzewczych systemów promieniujących.* Rocznik Ochrona Środowiska (Annual Set the Environment Protection), 15, 2293–2308, (2013).
10. **Dumała S.M., Dudzińska M.R.:** *Microbiological Indoor Air Quality in Polish Schools.* Rocznik Ochrona Środowiska (Annual Set the Environment Protection), 15, 231–244 (2013).

11. **Dumala S.M., Skwarczyński M.A.:** *Rozwiązania konstrukcyjno-instalacyjne budynku a zapotrzebowanie na energię ciepłą.* Rocznik Ochrona Środowiska (Annual Set the Environment Protection), 11, 1795–1808 (2011).
12. **Duran J., Golusin M., Ivanovic O.M., Jovanovic L., Andrejevic A.:** *Renewable Energy and Socio-economic Development in the European Union.* Problems of Sustainable Development, 8 (1), 105–114, 2013.
13. **Dyczkowska M., Szkarowski A.:** *Metoda energooszczędnego sterowania pracą instalacji grzewczych w budynkach o podwyższonej izolacyjności cieplnej – porównanie modelu matematycznego z wynikami badań.* Rocznik Ochrona Środowiska (Annual Set the Environment Protection), 11, 583–594 (2009).
14. **Fontana L.:** *Thermal performance of radiant heating floors in furnished enclosed spaces.* Applied Thermal Engineering 31, 1547–1555 (2011).
15. **Hajabdollahi F., Hajabdollahi Z., Hajabdollahi H.:** *Thermo-economic modeling and optimization of underfloor heating using evolutionary algorithms.* Energy and Buildings 47, 91–97 (2012).
16. **Jarzyńska W., Pawłowski A., Viktorovich N.:** *Technological development of wind energy and compliance with the requirements for sustainable development.* Problems of Sustainable Development, 9 (1), 167–177 (2014).
17. **Mroczek B., Kurpas D., Klera M.:** *Sustainable Development and Wind Farms.* Problems of Sustainable Development, 8 (2), 113–122 (2013).
18. **Odyjas A., Górka A.:** *Simulations of floor cooling system capacity.* Applied Thermal Engineering 51, 84–90 (2013).
19. **Pawłowski A.:** *Sustainable Development and Globalization.* Problems of Sustainable Development, 8 (2), 5–16 (2013).
20. **Pawłowski A., Pawłowski L.:** *Sustainable development in contemporary civilisation. Part 1: The environment and sustainable development.* Problems of Sustainable Development, 3 (1), 53–65 (2008).
21. **Rekstad J., Meir M., Kristoffersen A.R.:** *Control and energy metering in low temperature heating systems.* Energy and Buildings 35, 281–291 (2003).
22. **Wall G.:** *Exergy, Life and Sustainable Development.* Problems of Sustainable Development, 8(1), 27–41 (2013).
23. **Zhang L., Liu X.H., Jiang Y.:** *Simplified calculation for cooling/heating capacity, surface temperature distribution of radiant floor.* Energy and Buildings 55, 397–404 (2012).

Ocena zasilania pulsacyjnego systemu ogrzewania podłogowego na podstawie badań eksperymentalnych

Streszczenie

Badania eksperymentalne ogrzewania podłogowego w funkcji zasilania pulsacyjnego przeprowadzono w warunkach laboratoryjnych w skali półtechnicznej. Analizowany grzejnik podłogowy miał powierzchnię równą $2,43 \text{ m}^2$ i wymiary $1,56 \text{ m} \times 1,56 \text{ m}$. W celu odizolowania grzejnika od otoczenia, umieszczono go w komorze badawczej o wymiarach $1,56 \times 1,56 \times 2,21 \text{ m}$, której ściany były zaizolowane styropianem o grubości 10 cm . Ponadto ściany komory od wewnątrz były pomalowane na kolor czarny i charakteryzowały się stałą i znaną emisyjnością równą $\varepsilon = 0,95$. Komora badawcza była umieszczona w pomieszczeniu laboratorium, w którym temperatura powietrza wewnętrznego była utrzymywana na stałym poziomie równym 20°C .

Badania polegały na zasilaniu analizowanego układu czynnikiem grzewczym o temperaturze równej 45°C i przepływie objętościowym na poziomie $2,2 \text{ dm}^3/\text{min}$. Badania eksperymentalne wykonano dla siedmiu przypadków zasilania pulsacyjnego, które różniły się między sobą stosunkiem okresu zasilania układu do okresu przerwy w zasilaniu, jak i długością danego okresu. Na podstawie archiwizowanych pomiarów wyznaczono charakterystyczne parametry pracy układu, co pozwoliło na ocenę zużycia energii przez układ oraz parametrów komfortu cieplnego w pomieszczeniach ogrzewanych.

Zauważono, że dla krótkich czasów pracy i postoju, takich jak 15/15 min, temperatura operatywna jest praktycznie na stałym poziomie (wahania w granicach $0,2^\circ\text{C}$).

Poza tym największe wykorzystanie ciepła dostarczanego zauważono przy cyklach, które charakteryzowały się takim samym czasem trwania fazy grzania, jak i postoju.

Słowa kluczowe:

ogrzewanie podłogowe, regulacja, efektywność energetyczna

Keywords:

radiant floor heating, regulation, energy efficiency