

Dr hab. inż. Witold Biały Prof. PŚ

Silesian University of Technology, **Poland**

Jerry Wedzicha, PhD. P. Eng.

Provincial Mining Specialist, Ministry of Labour, Ontario, **Canada**

Assoc. Prof. Victor Nordin, PhD.

Kaliningrad State Technical University, **Russia**

Abstract. The article briefly describes the factors affecting the workability of coal seams. Next, the construction and principle of operation of a globally unique device for determining the values of forces involved in the cutting process (coal extraction) named POU-BW/01-WAP by the author were presented. It is the only device in the world that determines two of the three component forces that are involved in the cutting process. To this end, two independent measuring blocks were used, which consist of tensometric force sensors: cutting (F_s) and pick downforce (F_d). To register these forces, a real pick was used, which is used in longwall drum shearers - a conical pick. The device has ATEX certification that allows working in real conditions, as a device intended for use in potentially explosive atmospheres - in accordance with Directive 94/9/EC. The instrument has received many awards at global inventiveness and innovative solution trade shows.

Keywords: workability, device, component forces, experimental research, measurement

1. INTRODUCTION

Workability in a broad sense can be defined as the interaction between the material being excavated and the cutting machine (tool). In essence, it is the resistance of the excavated (fragmented) material against the cutting tool of the machine. Therefore, workability is one of the mechanical properties of useful minerals (hard coal, lignite, rocks). Workability is also treated by some researchers as a technological property (Baron et al., 1969; Bęben, 1992; Krauze, 2000; Jonak 2002; Biały, 2005). Depending on the mining technique, it can be determined as follows:

in drilling	drillability
in deep mining	workability, machinability
in surface mining	separation resistance

In each of the aforementioned mining processes, the technological process used is important. Dependencies are very loose between the above processes. Therefore, results obtained in one mining process cannot be approximated onto others. The mining process can be divided into active and passive. The influence of the material being cut on the wear of the tool used for this process is considered its active workability. Passive workability includes all those parameters that have an impact on the penetration of the mining tool into the mined mineral and the detachment of the extracted part from the face.

The mining process which takes place in natural conditions using a specific technology is a complex one (Krauze and Kotwica, 2007; Myszkowski and Paschedag, 2008; Biały 2002). This process usually differs significantly from the adopted model. Its complexity is shown in Figure 1.

Geological parameters can be determined as a set of mechanical and petrographic properties. From the perspective of workability, the most important is compressive strength. In contrast, petrographic properties are affected by the mineral composition, the share of hard minerals as well as the grain composition. A single property can not be a decisive parameter that determines workability. These parameters are immutable, i.e. we can not influence their change.

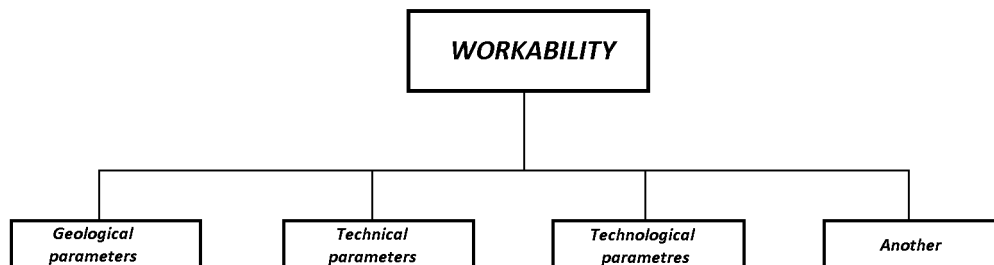

Fig. 1. Parameters affecting workability

Technical parameters are determined by the properties of the mining tool, which is closely related to the adopted mining technology. These properties include the geometry of the pick and the material from which the tool was made. The choice of the tool is made before starting the mining process and no changes are made during the process itself, despite the changing mining and geological conditions.

The technological parameters are determined by the technical parameters of the mining machine. These include the rotational speed of the cutting head, the speed of feed which in turn determine the size of the cutting groove and the efficiency. In the absence of full automation of the mining process, it is also influenced by the human factor. During the entire mining process, the operator changes the mining parameters as a result of the changing mining and geological conditions. This change occurs as a result of subjective decisions, and it is based on experience. These changes have a greater or lesser impact on the mining process.

The last group of parameters that has an impact on the mining process is difficult to predict. Here we can include the state of stress in the working zone of the mining machine, its size as well as the changing petrographic composition and the temperature of the mineral.

It follows that a relatively objective determination of workability is impossible without taking into account the aforementioned parameters.

In global mining, a number of methods are used to determine the workability of coal for the needs of mining mechanisation, which are determined in and interpreted in various ways. These indicators (of which many have been established) (Baron et al., 1969; Bęben, 1992; Krauze, 2000; Jonak 2002; Biały, 2005, 2011, 2013) reflect in different ways the mechanical properties of the coal seam. Therefore, the measurement of coal workability allows for an optimal selection of operating parameters of mining machines and can be one of the decisive factors for assessing the possibility of effective exploitation of a given plot or coal seam. This problem concerns the mining of coal using both shearer and and plow techniques.

2. MECHANICAL PROPERTIES OF ROCKS

Mechanical properties of rocks depend on factors such as:

- the type of rocks and their origin,
- rock tectonics (fissures, crevices, scratches, cracks, cleavage),
- rock porosity and dampness,
- grain size, shape and strength,
- binder (adhesive),
- direction of the force relative to the bedding.

The decisive mechanical properties of rocks include compressive strength, tensile strength, compactness, hardness and elasticity.

In practice, different ways of measuring workability are used. One of the easiest ways is to measure the amount of work needed to detach and fragment a volume unit of rock - this is expressed, for example, in J/m^3 . Depending on the means used for rock excavation, workability can be distinguished into (Baron et al., 1969; Bęben, 1992; Biały 2002, 2011):

- blasting workability, expressed as the number of kg of explosive used to excavate 1 m^3 of rock,
- drilling workability, ie. the so-called drillability, measured by the amount of time (in min) needed to drill e.g. 1 m of a hole,
- mechanical workability, determined by the workability index (machinability) A , A_ψ , W_{UB} in kN/m .

The hardness of a rock depends on its composition, homogeneity, grain size, quality of the binder. Hardness of rocks is not a feature that explicitly defines the strength of a rock, it does not indicate the specific strength properties of a rock, but it characterizes the rock in an indirect way. This property is taken into account when selecting the mining method. This parameter, (hardness) is described using the so-called Protodyakonov hardness index f . The higher the index value, the less workable the rock is.

The tensile and bending strength of rocks is much smaller than the compressive strength. They reach values:

- tensile strength of approximately 5 to 10% of the R_c value,
- bending strength of about 25 to 30% of the R_c value.

The general classification of rocks according to workability (intuitive, taking into account hardness, brittleness and other mechanical properties) is as follows:

1. very hard,
2. hard,
3. brittle,
4. soft,
5. loose.

In deep mining of hard coal, we usually deal with the first four types of rocks, as loose rocks occur very sporadically - they are practically non-existent.

3. FORCES IN THE CUTTING PROCESS

The cutting head excavates the face with cutting tools - picks that are fitted on it. In order to know the load on the cutting head and thus predict the power, it is important to know the values of forces that occur during the cutting process.

Shearer picks are replaceable elements fastened in handles welded to the cutting head. When describing the geometry of the location of the picks on the cutting head, the pick - pick holder pair is taken into account. Reaction forces from the rock act (concentrated in one point) on the one pick of the cutting head, which is subjected to the load caused by the reaction of the face to the pick being driven into it. The pick load is described by means of three mutually perpendicular forces (Fig. 2):

F_s – the cutting force,

F_d – the clamping force against the face,

F_b – the lateral force (resistance).

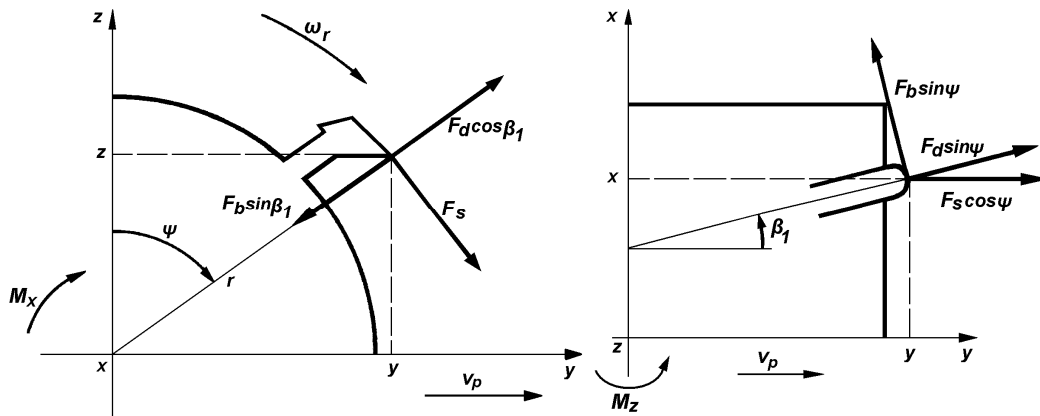

Fig. 2 Component forces in the cutting process

The direction of the F_s force coincides with the momentary direction of the tangent to the trajectory of motion (cycloid) of the tip of the pick's blade. The direction of the F_d force is perpendicular to the direction of F_s and is consistent with the direction of the line connecting the tip of the pick's blade and the origin, while the direction of the F_b force is perpendicular to the plane formed by the F_s and F_d forces. The position of the pick is determined by the angle ψ , while the angle of inclination β_1 of the knife edge in the horizontal plane takes into account the effect of the face on the helicoid of the cutting head (the presence of axial forces). All the components of the resultant reaction to the cutting force F_s were taken into account, as well as the clamping force F_d , resulting from the cutting head being driven into the face. The occurrence of this reaction is not related to the rotational movement of the cutterhead, therefore it was assumed that there is no component of the F_d force relative to the helicoid of the cutting head.

4. INSTRUMENT IMAGING THE WORK OF A SHEARER – POU-BW/01-WAP

A detailed analysis of the existing solutions and the author's experience in research on workability of coal seams were the basis for the development of construction assumptions for the construction of a new instrument.

The most important issues regarding the construction of the new instrument and the technology of conducting the research on the workability of coal in real conditions are shown in the diagram (Figure 3).

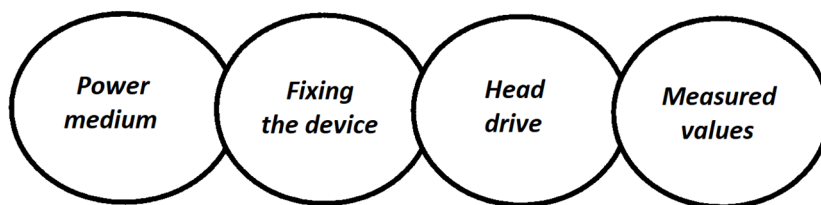

Fig. 3 Elements of the device and research technology

One of the basic problems that conditioned further actions was the choice of a medium supplying the device. As the main assumption was the operation of the device in underground conditions, and also due to the values of forces that can occur on the cutting head, hydraulic power was selected - in this case, water-oil emulsion was used. The advantage of this solution is its prevalence in the underground conditions of coal mining.

The next problem was the way of fixing the device in the excavation, so that the tests could be carried out in a stable manner. A solution for fixing the main frame of the device to two stands was adopted. The typical stands used in the mine were assumed, namely SHC/SHI stands. The disadvantage of this solution may be the difficulty with stabilizing the device in

high excavation sites. As an alternative solution, additional fixing by means of anchors attached to the side of work was assumed.

An important problem was the transmission of the drive to the arm on which the measuring pick is mounted. To avoid additional gears, an actuator has been proposed for driving the arm. It is a device that converts the reciprocating motion into a rotary motion. In this way, we obtain the arm drive from the hydraulic actuator without any additional devices.

A real pick (rotary) which is installed on drum shearers is attached at the end of the arm - this way we avoid geometry of the pick affecting the result of measurements.

As a device measuring the forces acting on the pick, strain gauges were used, which were fixed at the end of the arm in a special holder. The pick holder has been designed so that it is possible to measure two components of forces involved in the cutting process, i.e. the cutting force (F_s) and the clamping force to the cut stone (F_d).

The very end of the design phase consists of determining the measured values (in addition to forces), which should allow the assessment of the difficulty of mining the coal. A review of literature as well as the author's experience indicated the factors that have a significant impact on mining parameters. These include:

- measurement pick,
- forces acting on the pick,
- depth of the cut,
- side-crumble angle,
- volume of extracted coal.

For such assumptions, a documentation was made, based on which a device for testing the workability of coal and rocks surrounding the deposit was made, named POU-BW/01-WAP. The POU-BW/01-WAP device (the author of the present article is the main creator), assembled and ready for work, is shown in Figure 4 (WAP DAP, 2012; Biały, 2013, 2013a, 2014, 2015).

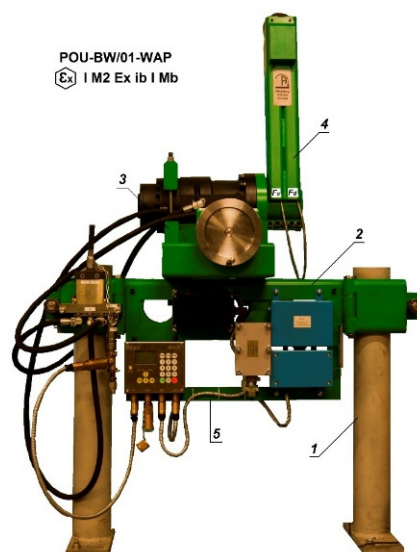

Fig. 4. The POU-BW/01-WAP device

5. MEASURING THE COMPONENT CUTTING FORCES USING THE POU-BW/01-WAP MEASURING HEAD

The main structural problem was the constructing the instrument's measuring head in such a way as to enable simultaneous measurement of as many forces as possible that are present in the process of cutting coal, and to make the measurement reliable (Jonak, 2002; Krauze and Kotwica 2007; Biały 2015). The conical picks (installed on the cutting head) rotate in the handles during operation, which makes it impossible to attach strain gauges directly onto them.

The measuring head used in the POU-BW/01-WAP instrument enables direct, simultaneous measurement of two out of three forces which occur in the cutting process (DAG EMAG, 2012):

- the cutting force F_s ,
- the clamping force against the face F_d .

The measuring head constructed in this way (Fig. 5) was installed at the end of the device's arm. The conical pick mounted in the head can rotate freely during the cutting process.



Fig. 5. The pick and measuring head with the pick installed

The measuring head is comprised of the following elements (Fig. 6):

1. Cutting pick,
2. Elastic element,
3. A 65x4 washer (oring),
4. Head cover,
5. Spacer ring,
6. Collet,
7. M8x1 stuffing box,
8. Ø6x20 fixing pin,
9. Axial sensor,
10. Casing of the axial sensor.

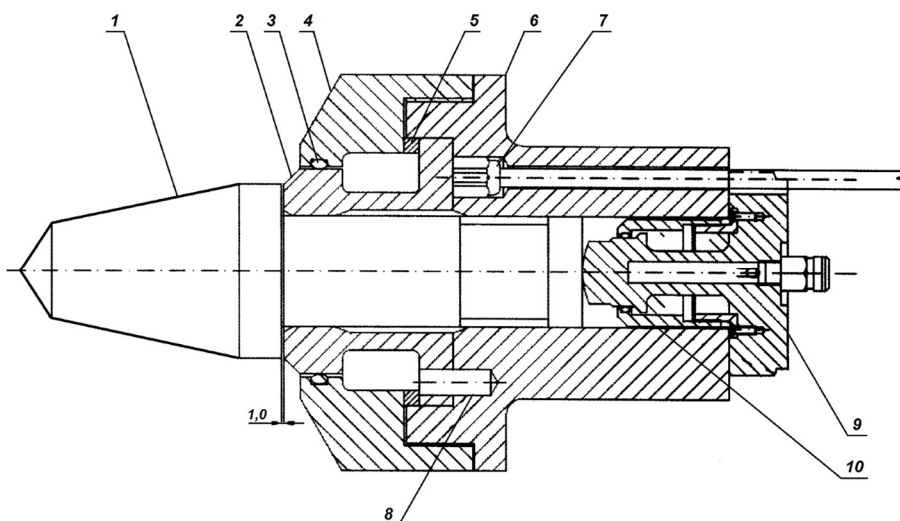

Fig. 6. Elements of the measuring head

A solution has been proposed that allows to easily measure forces, and then, thanks to known geometrical parameters of the device with the use of elementary formulas, to calculate load parameters, e.g. in the form of forces (torques).

Strain gauges were attached onto the POU-BW/01-WAP instrument's head in such a way that their base was consistent with the direction of the greatest stresses and, at the same time, the largest change in the length of the measuring element (bending). Separation of the cutting force component F_s is obtained by the compensation method, by appropriate summing and subtraction (each time) of the results from the bridge located on the bending side (Figure 7).

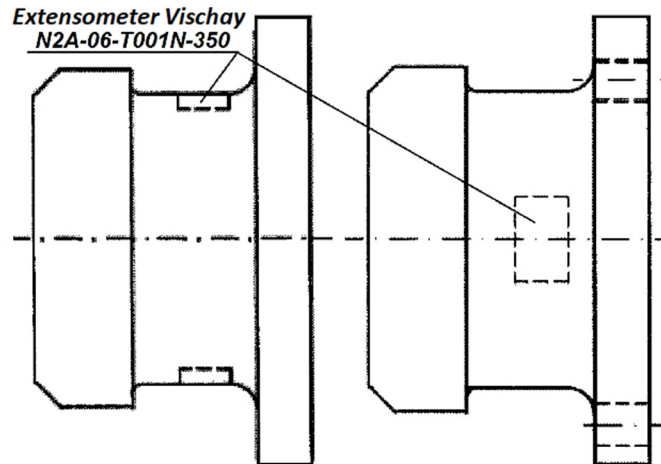

Fig. 7. Location of strain gauges measuring the cutting force F_s

By contrast, the pick clamping force F_d is obtained from the strain gauge bridge located in the lower part of the head where compression occurs (Fig. 8).

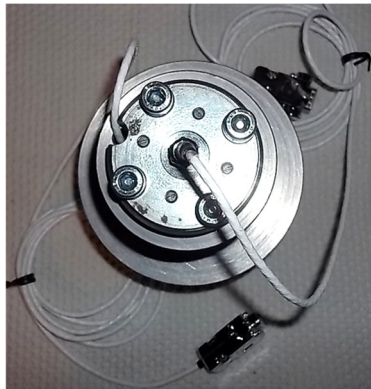

Fig. 8. View of the pick clamping force F_d sensor

6. CALIBRATION OF THE F_s AND F_d SENSORS ON THE MEASURING HEAD

The process of calibrating force sensors (F_s , F_d) on the POU-BW-01-WAP measuring head was carried out for known loads at the ZEPWN test station in Marki (Protokół 2014, 2014a). The graph showing the dependence between the mV value and the given force (kN) is shown in the graph (Fig. 9).

The report on the technological calibration of the nominal sensitivity and non-linearity of the F_s forces is shown in Fig. 10.

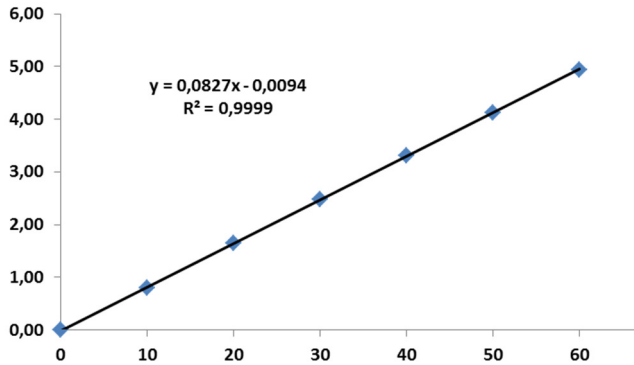

Fig. 9. Dependence of voltage in mV on the given cutting force F_s

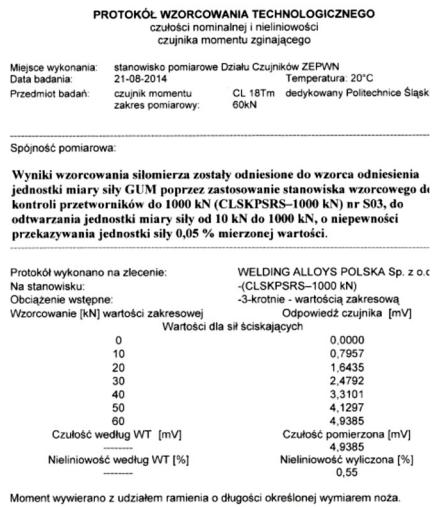

Fig. 10. Report from the technical calibration of the F_s force.

For the cutting force F_s sensor, the calibration results were referenced with the GUM measurement unit standard, by using a reference station to control transducers up to 1000 kN (CLSKPSRS-1000 kN) No. S03 for the reconstitution of a unit of measure of force from 10 kN to 1000 kN, with uncertainty of transferring a unit of force of 0.05% of the measured value. The torque was exerted by the arm with a length determined by the size of the pick (80 mm). They were loaded with forces from 0 to 60 kN with an interval of 10 kN and the sensor readings in mV/V were read.

The graph showing the dependence of the mV values obtained on the set force (kN) for the pick clamping force F_d is shown in the graph (Fig. 11), while the technological calibration protocol of the nominal sensitivity and non-linearity of the F_d force is shown in Fig. 12.

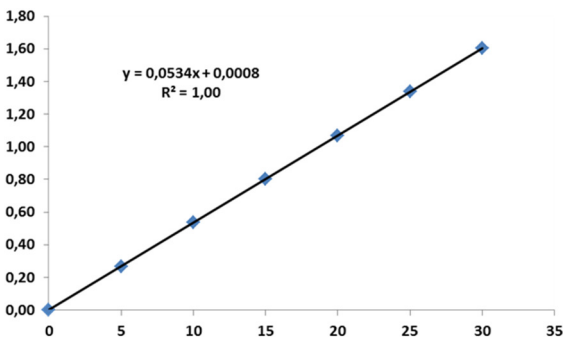

Fig. 11. Dependence of voltage in mV on the set F_d clamping force

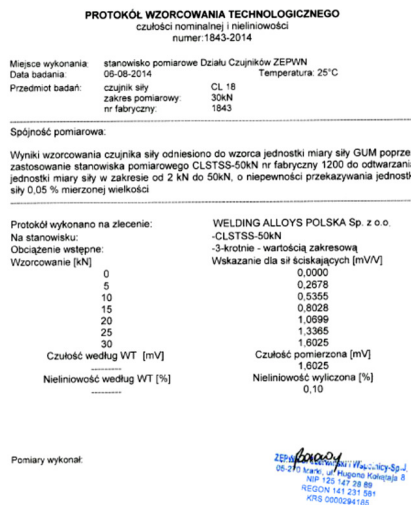

Fig. 12. Technological calibration protocol of the F_d force

The results of pick clamping force F_d calibration were referred to the GUM standard unit of measurement at the CLSTSS-50kN measuring station (serial number 1200) to reconstruct the unit of measure of force in the range from 2 kN to 50 kN, with uncertainty of transferring the unit of force of 0.05% of the measured value. For the clamping force F_d , the sensor was loaded with forces from 0 to 30 kN in 5 kN intervals and the sensor readings in mV/V were read. For each of the forces: cutting force F_s and pick clamping force F_d , the preload was performed three times for the entire range.

7. TEST BENCH VERIFICATION

In order to verify the results of tests calibrating the values of F_s and F_d forces on the measuring head, verification tests were carried out on the test bench. The test station was built at the Department of Machines and Design, Faculty of Mechanical Engineering at VSB-TU in Ostrava-Poruba. The verification tests were carried out in the Department's laboratory (Fig. 13).

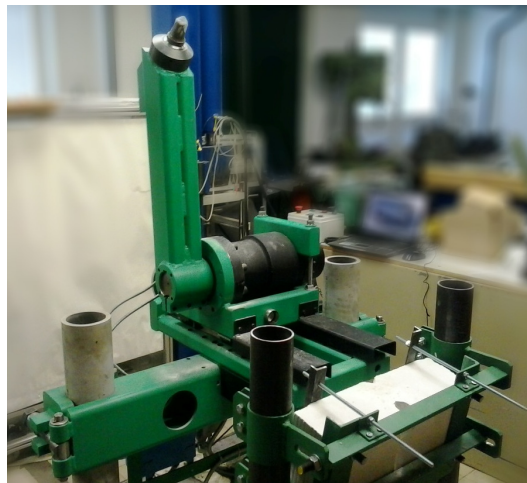

Fig. 13. Test stations for workability testing

Measurement cuts (Fig. 14) were made at a constant cut depth (10 mm), in a material with known parameters.



Fig. 14. Measurement cut

The obtained values of the cutting and clamping forces were recorded by the measuring and recording device of the instrument (Pop-1 operator panel, Fig. 15) and stored in the device's memory (PISMM - Portable Intrinsically Safe Memory Module).



Fig. 15. Operator panel with screen

Sample values obtained during one measuring cut stored in the device memory are shown in Fig. 16.

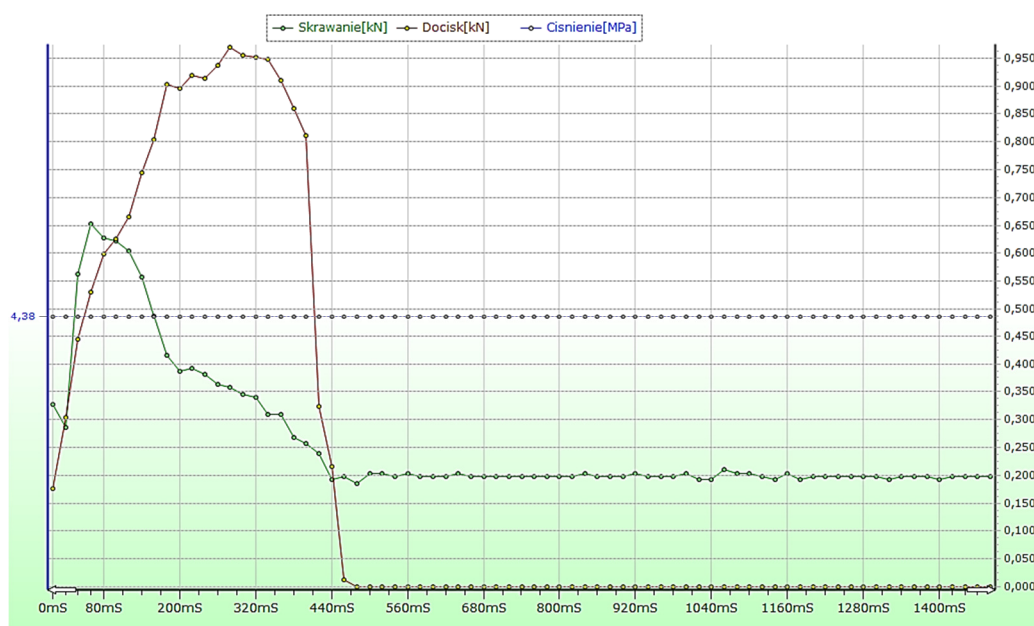

Fig. 16. Change in the values of cutting and clamping forces during one cut

The results obtained during the laboratory tests on the material with known parameters confirmed that the values obtained coincide with the actual values for the tested material. Thus, confirmation was obtained that the results are reliable.

8. CONCLUSION

Due to the very specific working conditions of machinery and equipment used in coal mining, the method of selection, taking into account the changing conditions during their operation, is important. The correct selection, affects the increase in durability and reliability of machines and devices, which translates into the economic results achieved.

It is particularly important to measure the load of the cutting head during mining, which is possible by measuring the forces on the picks installed on the head. Knowing the values of forces acting on the individual picks of the cutting head, we can determine the total load of the head during the mining process. This knowledge will allow for an optimal selection of operating parameters for the mining machines and can be one of the decisive factors for assessing the possibilities of effective exploitation.

The research and analyses carried out so far show that the value of the workability index (expressed by cutting forces) has a significant impact on the power, efficiency, durability and reliability of mining equipment.

The presented POU-BW/01-WAP device is the only device in the world which allows for measuring two component forces present in the coal mining process (F_s and F_d) simultaneously. Because the device is equipped with two tensometric force sensors and a pressure sensor, it is possible to determine these two cutting forces from two independent measurement sources. Thus, we have the opportunity to verify the obtained measurement results - cutting force (F_s) and pick clamping force (F_d). In addition, as a result of the device being equipped with a pressure sensor, it is also possible to determine the momentary mining (cutting) power for the coal (the rock surrounding the deposit).

Workstation tests, which were carried out with the POU-BW/01-WAP device on a test station at the Department of Working Machines and Designing of the Mechanical Faculty of VSB-TU in Ostrava-Poruba, fully confirmed the reliability of the results obtained.

ACKNOWLEDGEMENTS

The paper is the result of statutory research carried out at the Institute of Production Engineering at the Faculty of Organization and Management of the Silesian University of Technology as part of a project number 13/030/BK_18/0039 called "Development of intelligent production methods as well as work and life environments in the context of production engineering challenges".

REFERENCES

- Baron, L.J. and Głapman, L.B. (1969). Wzrost instrumenta przy rzeźnieniu górnictwa. Moskwa: Hedba.
- Bęben, A. (1992). Technika wiertnicza w odkrywkowym górnictwie skalnym. Katowice: Wydawnictwo Techniczne.
- Biały, W. (2002). The side-crumble angle ψ of coal and the energy consumption of the mining process as a function of the vertical component σ_z of exploitation pressure. *Polska Akademia Nauk, Archiwum Górnictwa* tom 47 nr 3. s. 361-384.
- Biały, W. (2005). Empiryczne prognozowanie mocy ścianowych kombajnów bębnowych. *Zeszyty Naukowe Politechniki Śląskiej, seria Górnictwo, Monografia z. 262*. Gliwice: Wydawnictwo Politechniki Śląskiej.
- Biały, W. (2011). The selection of optimal method determining mechanical properties of coal layers. *Management Systems in Production Engineering* no. 2 ISSN 2299-0461. s. 26-30.
- Biały, W. (2013). Innowacyjne narzędzia do wyznaczania właściwości mechanicznych węgla. *Przegląd Górniczy* nr 6. Katowice. ISSN 0033-26X. s. 17-26.
- Biały, W. (2013a). New devices used in determining and assessing mechanical characteristics of coal. 13th SGEM GeoConference on Science and Technologies In Geology, Exploration and Mining, SGEM2013 Conference Proceedings, ISBN 978-954-91818-7-6/ISSN 1314-2704 June 16-22.2013. Vol. 1. s. 547-554.
- Biały, W. (2014). Coal cutting force measurement systems – (CCFM). 14th SGEM GeoConference on Science and Technologies In Geology, Exploration and Mining, SGEM2014 Conference Proceedings, June 17-26, 2014, Vol. III, BULGARIA ISBN 978-619-7105-09-4/ISSN 1314-2704. s. 91-98.
- Biały, W. (2015). Innovative solutions applied in tools for determining coal mechanical properties. *Management Systems in Production Engineering* vol. 4(20). Gliwice. ISSN 2299-0461. pp. 202-209. DOI: 10.12914/MSPE-02-04-2015
- Bołoz, Ł. (2018). Model tests of longwall shearer with string feed system. *Archives of Mining Sciences*, vol. 63 no. 1, pp. 61-74, DOI 10.24425/118885.
- Dokumentacja Techniczno-Ruchowa POU-BW/01-WAP, (2012). *Welding Alloys* Polska sp. z o.o. Gliwice.
- Dokumentacja Techniczno-Ruchowa. (2012). *Urządzenie do Pomiaru Siły Skrawania Węgla*. ITI EMAG. Katowice.
- Jonak, J. (2002). *Urabianie skał głowicami wielonarzędziowymi*. Katowice: „Śląsk” Sp. z o.o. Wydawnictwo Naukowe.
- Krauze, K. (2000). *Urabianie skał kombajnami ścianowymi*. Katowice: „Śląsk” Sp. z o.o. Wydawnictwo Naukowe.
- Krauze, K. and Kotwica, K. (2007). Selection and Underground Tests of the Rotary Tangential Cutting Picks used in Cutting Heads of the Longwall and Roadway Miners. *Polska Akademia Nauk, Archiwum Górnictwa* tom 52 nr 2. s. 195-217.

- Krauze, K., Bołoz, Ł. and Wydro, T. (2015). Parametric factors for the tangential-rotary picks quality assessment. Archives of Mining Sciences, vol. 60, no. 1, DOI: 10.1515/amsc-2015-0018,
- Myszkowski, M. and Paschedag, U. (2008). Longwall mining In seams of medium thickness – comparison between shearer and plow. 21st. World Mining Congress, Kraków.
- Protokół wzorcowania technologicznego czujnika momentu 2014a, CL 18Tm z dnia 21.08.2014. ZEPWN J. Czerwiński i Wspólnicy, spółka jawna. Marki, ul Kołtątaja 8.
- Protokół wzorcowania technologicznego czujnika siły 2014, CL 18 z dnia 06.08.2014. ZEPWN J. Czerwiński i Wspólnicy, spółka jawna. Marki, ul Kołtątaja 8.