

Original Study

Open Access

Adam Krasiniński*, Mateusz Wiszniewski

Identification of residual force in static load tests on instrumented screw displacement piles

<https://doi.org/10.2478/sgem-2021-0025>

received May 29, 2021; accepted September 7, 2021.

Abstract: Occurrence of the so-called residual force of an unknown value significantly disturbs interpretation of static load tests performed on piles equipped with additional measuring instruments. Screw displacement piles are the piling technology in which the residual force phenomenon is very common. Its formation mechanism is closely related to the installation method of this type of piles, which initiates generation of negative pile skin friction without any additional external factors. Knowledge of the value and distribution of a residual force (trapped in a pile shaft before starting the load test) is a necessary condition for the proper interpretation of instrumented pile test results.

In this article, a clear and easy-to-use method of residual force identification, based on the analysis of shaft deformations recorded during pile unloading is presented. The method was successfully verified on two pile examples and proved to be effective and practical.

Keywords: residual force; pile load test; pile instrumentation; load distribution; displacement pile.

1 Introduction

The accuracy and credibility issue of interpretation of measurements carried out during load tests on instrumented piles is still difficult and complex. It is evidenced by numerous publications that describe and analyse the problem, for example, Fellenius et al. (2000), Fellenius (1989, 2001, 2002c), Hayes and Simmonds (2002), Krasiniński (2012) and Maertens and Huybrechts

(2003). The interpretation results are largely influenced by factors such as:

- geometric heterogeneity of the pile shaft along its length (thickening, narrowing);
- material heterogeneity of the pile core (variability of the concrete quality and stiffness modulus with the depth and stratification of the soil; non-linear characteristics of this stiffness);
- pile reinforcement heterogeneity (variable number of longitudinal bars along the pile);
- inaccuracy and unreliability of the measuring system (type of equipment used – vibrating wire extensometers or fibre optic systems), important due to small values of the measured deformation and
- occurrence of an initial axial force of unknown value in the pile shaft (so-called residual force) before the start of the pile load test.

This article deals with the last mentioned factor concerning the residual force, considered in case of screw displacement piles. During interpretation and analysis of numerous load test results (performed on screw displacement piles), the authors have observed symptoms indicating the presence of residual forces. Based on the analyses and established regularities, a proposal of how to identify the residual force value and then how to apply it in the results interpretation was developed. The article describes the procedure of such identification and presents its verification based on two selected load tests performed on screw displacement piles equipped with retrievable vibrating wire extensometers.

2 The main idea of instrumented pile testing

The purpose of performing instrumented pile load tests is to determine the value and distribution of the axial force along the pile shaft, which then allows to determine the contribution of individual soil layers along the shaft and under the pile base in transferring the external load

*Corresponding author: Adam Krasiniński, Faculty of Civil and Environmental Engineering, Gdansk University of Technology, Gdansk, Poland, E-mail: adam.krasinski@pg.edu.pl

Mateusz Wiszniewski, Faculty of Civil and Environmental Engineering, Gdansk University of Technology, Gdansk, Poland

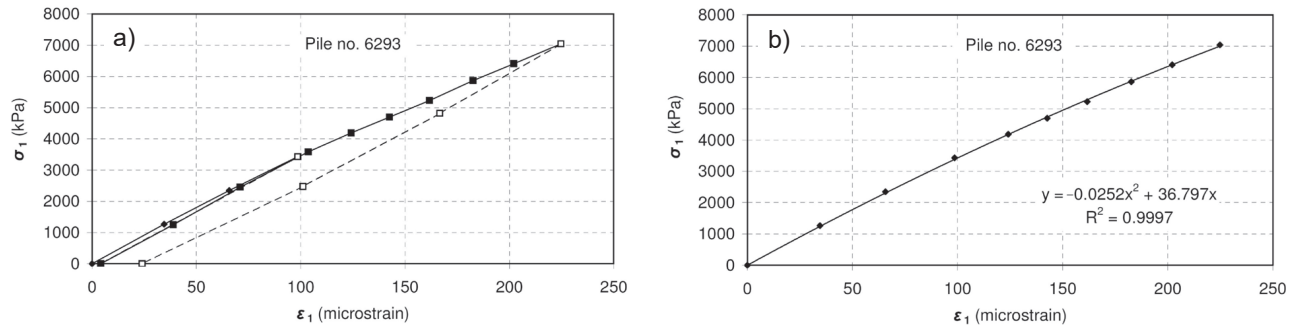

Figure 1: The stress–strain relation measured in the first section of the pile (pile no. 6293): a) general for loading and unloading, b) only for loading, described by a function.

applied to the pile head. Tests rely on measurements of the pile shaft deformation, currently carried out using vibrating wire extensometers or the fibre optic technique. Due to relatively low deformation values, high accuracy of the measuring device is required. More favourable measurement results are obtained with the fibre optic technique, mainly due to higher resolution (Kania and Sørensen, 2018; Sieńko et al., 2018). The disadvantage of which, however, is higher cost, more complicated technology that requires specialised and qualified service and problems with temperature compensation.

The value of axial force (Q_{ji}) at individual depth (j) and in subsequent load level (i) is obtained from the calculation based on the stress–strain relationship determined in situ in the first measuring section, located just below the pile head. This is called the reference section, which should be exposed (excavated) from the ground before the test starts. Therefore, due to direct measurements, values of the force (Q_{ji}), deformation (ϵ_{ji}) and the real pile cross-section area (A_j) are established. The excavation of the first section (G1) also eliminates soil frictional resistance on the pile shaft surface. The stress–strain relationships determined from these measurements usually have slightly non-linear courses and differ for primary load, unloading and reloading. In order to improve the quality of interpretation, the mentioned non-linearities and differences should be taken into account during analyses. The stress–strain characteristic is then sequentially transferred to lower pile sections to determine the forces (Q_{ji}).

Examples of the σ – ϵ characteristic are shown in Fig. 1 and obtained on its basis the distribution of axial force along the pile is presented in Fig. 2. The results from Fig. 2, in connection with pile settlement measurements (displacement), are a good starting point for further analyses, for example, determination of soil unit resistance along the shaft and under the pile base (examples are given further in the article).

The discussed interpretative approach is subjected to errors resulting from possible heterogeneity of the concrete stiffness modulus (E) and the cross-section area (A) of the pile along its length (especially in cast-in-place piles). It would be very useful to fully extract pile from the ground (Maertens and Huybrechts, 2003), which unfortunately is rarely possible and additionally technically burdensome. Large inhomogeneities can sometimes be picked up from the measurements themselves and corrected accordingly.

3 The mechanism of residual forces generation in screw displacement piles

Presence of residual forces in the pile shafts of various technologies has been the subject of many publications, including Cooke (1979), Fellenius et al. (2000), Fellenius (2002c), Maertens and Huybrechts (2003), Kim et al. (2004), Siegel and McGillivray (2010), Krasieński (2012) and Sahajda (2015). In the case of screw displacement piles, initial compressive forces might be generated mainly as a result of negative friction occurring in the upper parts of the subsoil (Fellenius, 2002a; Van Impe et al., 2013). This friction is caused by the secondary settlement of the soil, which was raised during pile formation by a displacement auger. In that process, poorly permeable soils deform with practically no volumetric changes and excess pore water pressure is generated. While this excess is slowly dissipated, layers of poorly permeable soil are consolidated and aforementioned secondary settlement occurs. Soil consolidation takes a long time and may also continue after the concrete has hardened and causes the activation of compressive force in the pile shaft. The discussed mechanism is presented graphically in Fig. 3. In critical cases, due to the residual force, the pile shafts

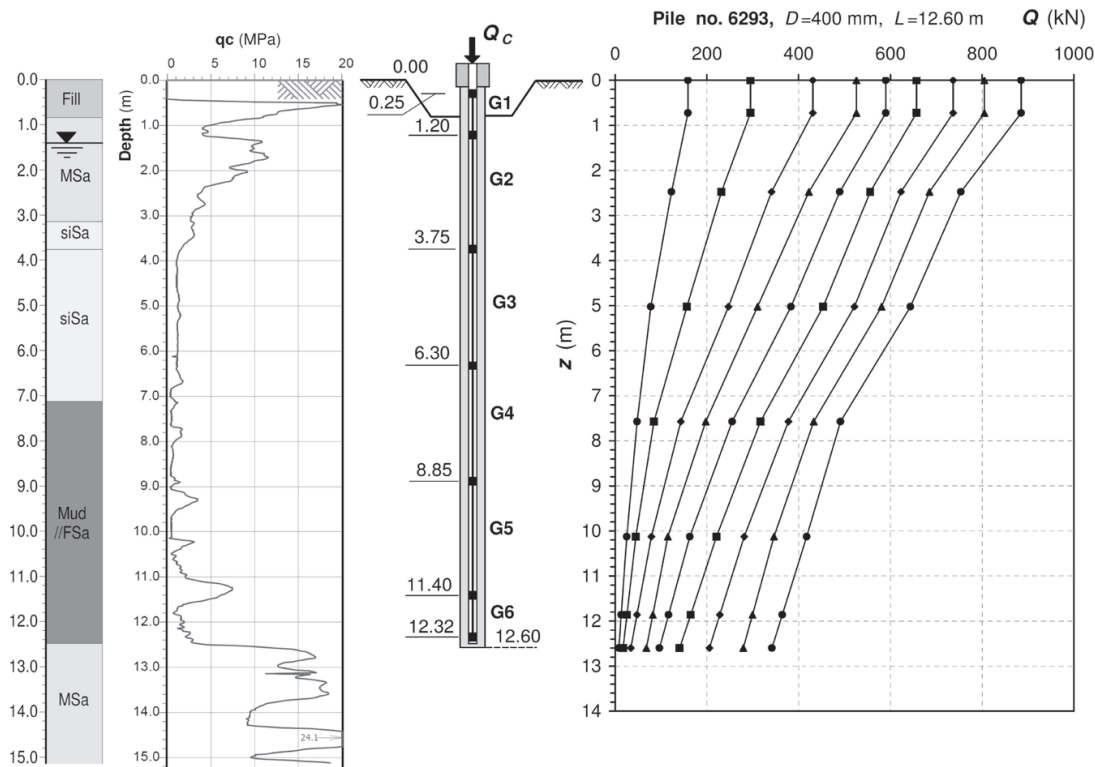

Figure 2: Axial load distribution along the pile shaft (pile no. 6293)

may even get damaged in the early stages of concrete maturation (with still low strength). Movement of a heavy construction equipment (e.g. pile machine) on the ground level might be an additional factor causing negative friction. The mentioned compressive force in the pile shaft is generally referred to as residual force, although this name is more appropriate for the case of driven piles.

It is not always easy and possible to determine the presence of initial compressive force in the pile shaft. We may find out about its existence during the intermediate or final unloading of the pile. If in all measuring sections, after unloading remain permanent deformations (permanent shortenings), it can be assumed that there was little or no initial compressive force in the pile before the load test was started. However, if in some measuring sections, the deformations after unloading are of the opposite sign (elongation), this is a clear evidence of the initial compressive force. An example of such a situation is shown in Fig. 4. The described phenomenon has been observed in the vast majority of tests on instrumented screw displacement piles, of which the authors have so far carried out over 50.

4 Proposed method for estimating the residual force value in the pile shaft

Fellenius (2002a) has proposed an identification method based on the concept that residual force value in the upper pile sections is equal to a fully mobilised negative skin friction of the pile. Therefore, the soil resistance obtained from uncorrected load test in these layers consists of two directions of friction (negative and positive); that means, its value is doubled and for proper interpretation, it should be divided by 2. In the lower pile sections, 'true' soil resistance value is determined from the correlations based on CPTu sounding. Then, the residual force can be assessed by extracting the estimated uncorrected soil resistance value (based on pile load test results) from the one based on CPTu sounding (for more details of the Fellenius method, see Fellenius (2002a, 2002b, 2015)). The method has been tested and verified to be legitimate (Kania et al., 2020); however, it must be underlined that it is only an estimation. Authors indicate that the value of initial compressive force (residual force) in the pile shaft can be estimated directly from deformations of the measuring

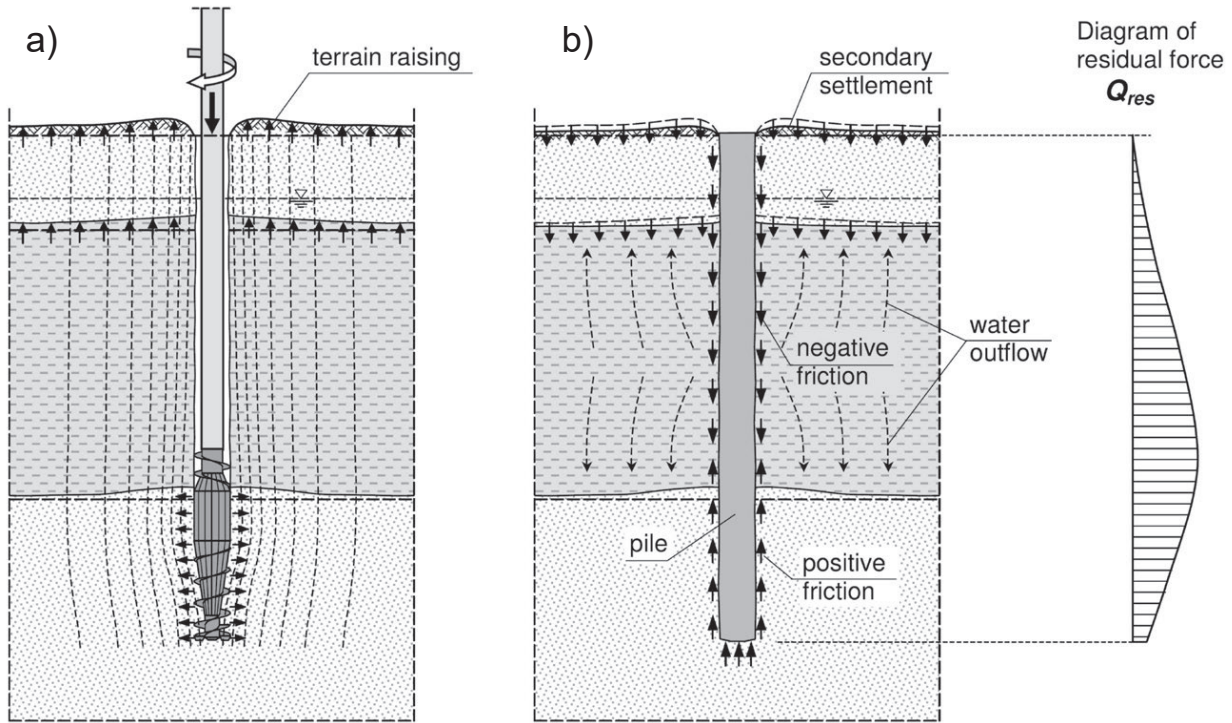

Figure 3: The mechanism of residual force generation in a screw displacement pile: a) phase of soil spreading by the auger, b) phase after the pile is completed and the concrete has hardened.

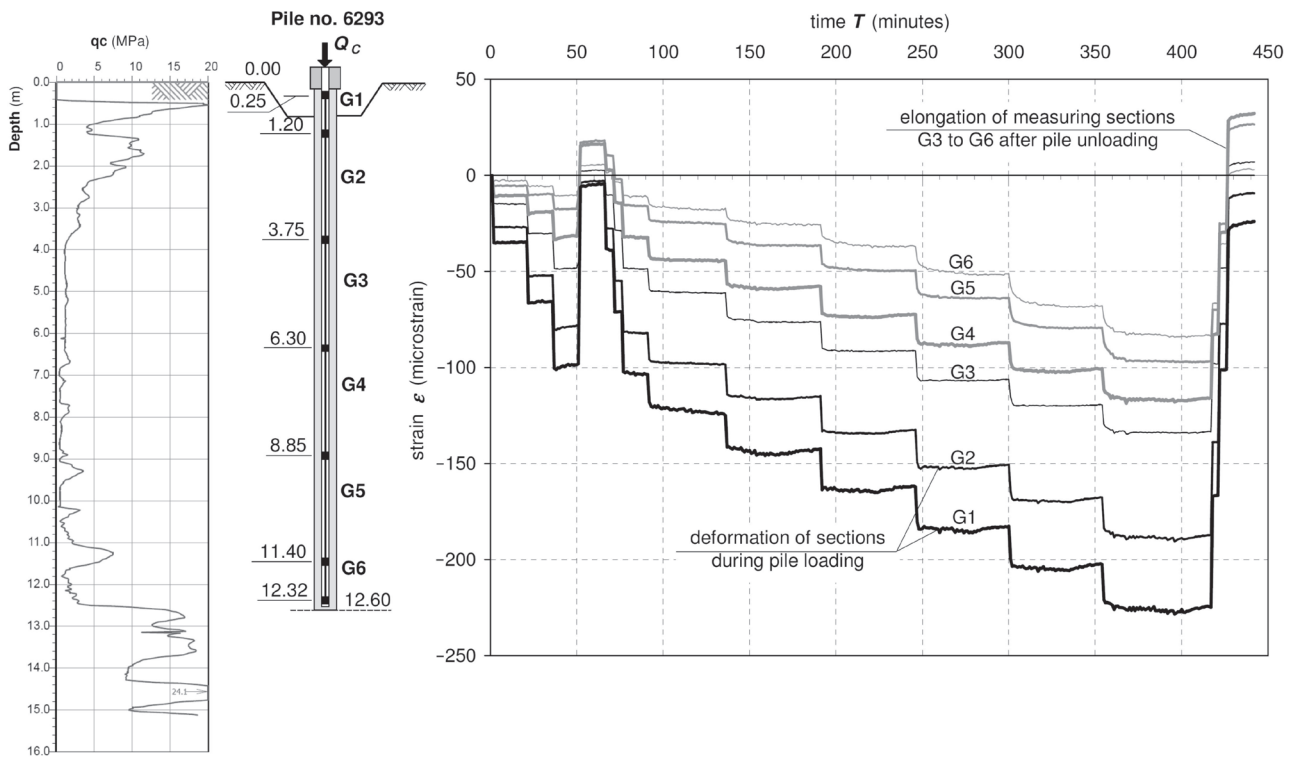

Figure 4: An example of test result with the presence of initial compressive (residual) force in the pile shaft found due to shaft elongation after unloading (pile no. 6293).

sections recorded during the pile unloading phase. For this purpose, the concrete stress–strain characteristic in the first measuring section (G1), corresponding to the pile unloading phase, should be determined. The characteristic should be defined for changes (decreases) in stress and changes in concrete deformation, calculated according to the equations (1, 2) given as follows:

$$\text{stress change: } \Delta\sigma_{1;i} = \sigma_{1;\max} - \sigma_{1;i} \quad (1)$$

$$\text{deformation change: } \Delta\varepsilon_{1;i} = \varepsilon_{1;\max} - \varepsilon_{1;i} \quad (2)$$

where $\sigma_{1;\max}$ and $\varepsilon_{1;\max}$ are the values of stress and deformation in the first section for the last (maximum) stage of pile loading (just before unloading) and $\sigma_{1;i}$ and $\varepsilon_{1;i}$ are the values of stress and strain in the first section for a given stage (i) of pile unloading.

In the final stage (f) of pile unloading (with complete zeroing of the force Q_c) (3),

$$\Delta\sigma_{1;f} = \sigma_{1;\max} \text{ and } \Delta\varepsilon_{1;f} = \varepsilon_{1;\max} - \varepsilon_{1;f}, \\ \text{where } \Delta\varepsilon_{1;f} \leq \varepsilon_{1;\max} \quad (3)$$

The above method allows to take into account permanent concrete deformation and concrete (pile material) stiffness at the unloading stage, which has changed in relation to its value at primary loading. The obtained characteristic of $\Delta\sigma_1 - \Delta\varepsilon_1$ should be presented in a graph form, which should be described by the function $\Delta\sigma_1 = f_1(\Delta\varepsilon_1)$, linear or non-linear, depending on which one describes the graph more precisely. Sample graph is shown in Fig. 5.

It was observed that the higher concrete class and reinforcement in the pile shaft are, the lower permanent deformation and the more linear the $\Delta\sigma - \Delta\varepsilon$ relationship, which generally improves the interpretation accuracy.

The values of forces Q'_{ji} at the given sections (j) and in the pile unloading stages (i) are calculated from equation (4):

$$Q'_{j;i} = Q_{j;\max} - f_1(\Delta\varepsilon_{j;i}) \cdot A_j \quad (4)$$

where A_j is the average cross-sectional area of a pile at a given section (j); if there is no indication to the contrary, it can be assumed that $A_j = A_1$ for the entire pile.

If in the final (f) stage of pile unloading (when the Q_c force is zeroed), negative values of some forces are obtained ($Q'_{j;f} < 0$), it means that in these sections, there was a compressive residual force of the value of at least (5):

$$Q_{j;res} = -Q'_{j;f} \quad (5)$$

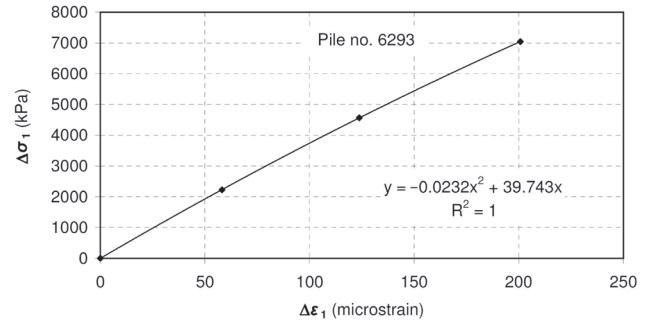

Figure 5: The stress–strain relation in the first measuring section of the pile shaft, determined for the unloading phase and described by function (for the same example as in Fig. 1, pile no. 6293).

Such a case can be seen, for example, in Fig. 8a. It should be taken into account that some sections cannot fully relax due to the soil resistance along the pile shaft. This phenomenon can be neglected in case of weak soil layers along the upper part of pile shaft. Additionally, it may be advantageous to perform an additional one or more load–unload loops, resulting in a further gradual degradation of the residual soil resistance along the pile shaft. If during such loops, an additional increase in the pile sections' length is observed, then estimation of the residual force values ($Q_{j;res}$) can be improved (increased). If not, it can be assumed that the pile shaft has already fully relaxed. When further interpreting the test results, the estimated residual force values should be entered as initial values (assume stage no. '0') and the force values determined according to the standard procedure should be added in successive stages (see Fig. 8b or Fig. 16c).

5 Example cases

The proposed method of estimating the residual force value was used to interpret the test results of two exemplary instrumented screw displacement piles. Piles differ significantly in length (12.6 and 7.5 m) and in the ground conditions they were embedded in (two different experimental fields). Pile no. 6293 was installed in the substrate dominated by organic and non-cohesive soils, and pile no. 9 in the substrate composed mainly of cohesive soils. Ground conditions were identified by CPTu soundings. During the static load tests of both piles, vibrating wire extensometers measuring system was used (six and seven retrievable Geokon 1300 Model A-9 extensometers). In both cases, elongation of the pile shafts after unloading was observed, which allowed to qualify these cases for further analysis.

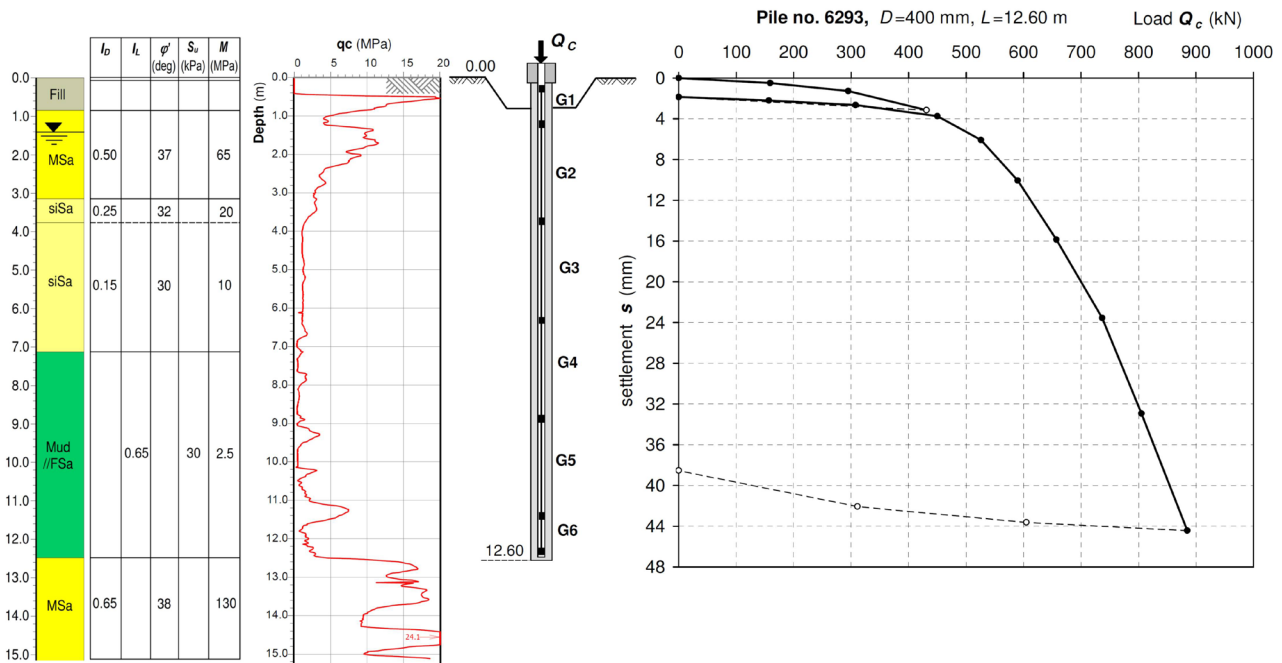

Figure 6: Pile no. 6293, CPTu sounding and the basic result of the load test

5.1 Example 1 – pile no. 6293

Pile no. 6293, with a diameter of $D = 400$ mm and a length of $L = 12.6$ m, was made with a prototype proprietary auger Displacement Pile Drilling Tool (DPDT), patented in Poland (patent no. PL 235442 B1). Pile of concrete class C30/25 reinforced with 6 ribbed bars $\varnothing 16$ mm was installed in a testing field located on the outskirts of Gdansk ('Zulawy Wislane' area). The result of the CPTu sounding performed exactly at the pile location is shown in Fig. 6, together with soil classification by Robertson (1990) and basic geotechnical parameters determined from the correlations by Lunne et al. (1997). This figure also shows the pile scheme and the basic result of the pile load test in the form of a load settlement graph (Q_c-s).

The interpretation results of extensometric measurements have already been presented in Fig. 1 and 2. Fig. 4 shows measured deformations of the individual pile sections, where an evident elongation of sections G3–G6 can be observed after the pile was completely unloaded.

In the first stage, test and measurement results were interpreted without any residual force effect. The result of such an interpretation in the form of force distribution along the pile in successive load steps is shown in Fig. 2. After further analyses and calculations, charts of unit soil resistance mobilisation along the shaft q_s and under the pile base q_b were obtained and are shown in Fig. 7.

In the second stage, test results were interpreted according to the influence of residual force Q_{res} . For this purpose, the relation $\Delta\sigma_1-\Delta\varepsilon_1$ was determined for the first measuring section of the pile shaft (pile unloading). This relation was described by a quadratic function $f_1(\Delta\varepsilon_1)$ and is shown in Fig. 5. On its basis, graphs of axial forces in the pile during unloading were then determined, which in the final phase gave a graph of the residual force Q_{jres} (Fig. 8a). The maximum value of Q_{res} , exceeding 180 kN, occurred at the measurement point G4. The value of residual force was next added to axial force distributions in successive load steps (Fig. 8b). As in the first stage, charts of unit soil resistance mobilisation on the shaft q_s and under the pile base q_b were obtained, which are shown in Fig. 9.

For comparative purposes, the graphs of unit resistances q_s and q_b obtained from both interpretation stages are summarised in Fig. 10. There are significant differences in values, especially for q_s resistances at individual measuring sections. Taking into account the residual force Q_{res} resulted in a decrease of frictional resistance value in the upper sections ($q_{s,1}$, $q_{s,2}$ and $q_{s,3}$), while an increase in the lower sections ($q_{s,4}$ and $q_{s,5}$) was observed. Particularly, significant differences were found in the resistances $q_{s,5}$ – from about 20–25 kPa in the first stage to about 70 kPa in the second stage. In the case of q_b resistances at the pile base, some differences were also observed, however less significant. After taking the residual force Q_{res} into account, the q_b value increased from

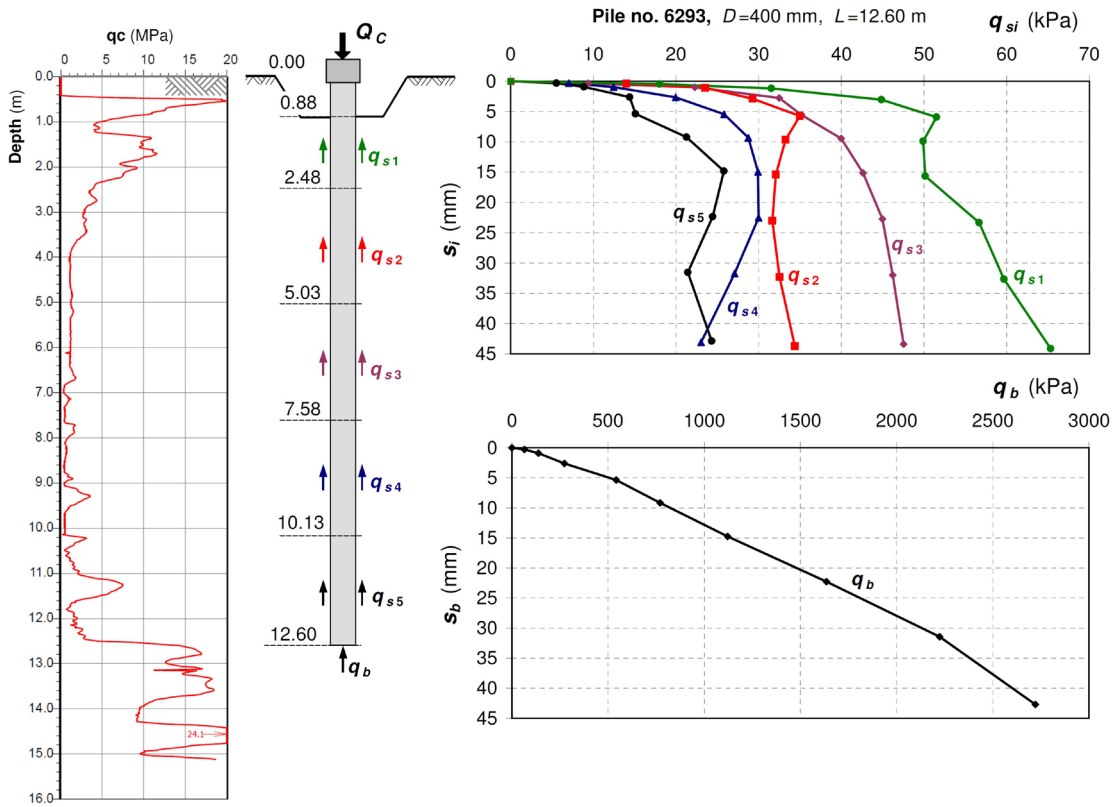

Figure 7: Pile no. 6293, interpretation of q_s and q_b unit soil resistances around the pile, based on the data from Figs 2 and 6, without taking into account the influence of the residual force.

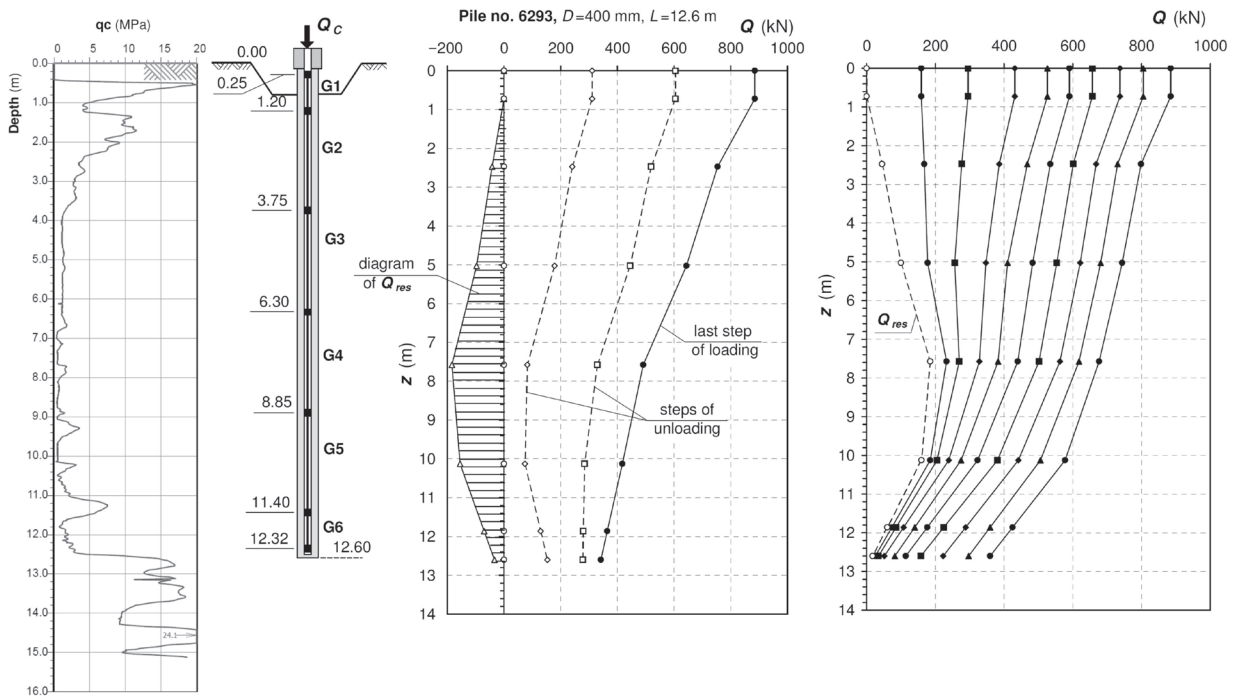

Figure 8: Pile no. 6293: (a) determination of the residual force in the pile shaft and (b) its inclusion in the distribution of the axial force along the pile in successive load steps.

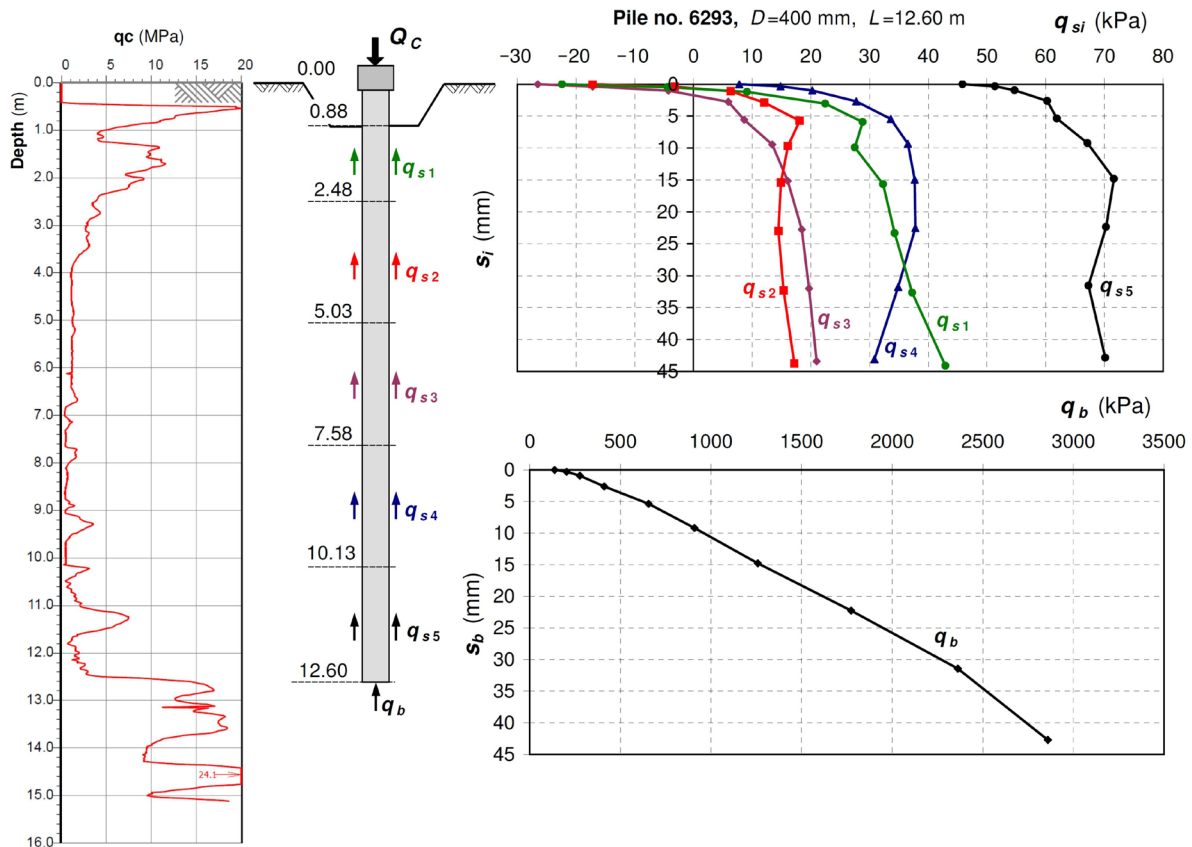

Figure 9: Pile no. 6293, interpretation of q_s and q_b unit soil resistances around the pile after taking the residual force into account.

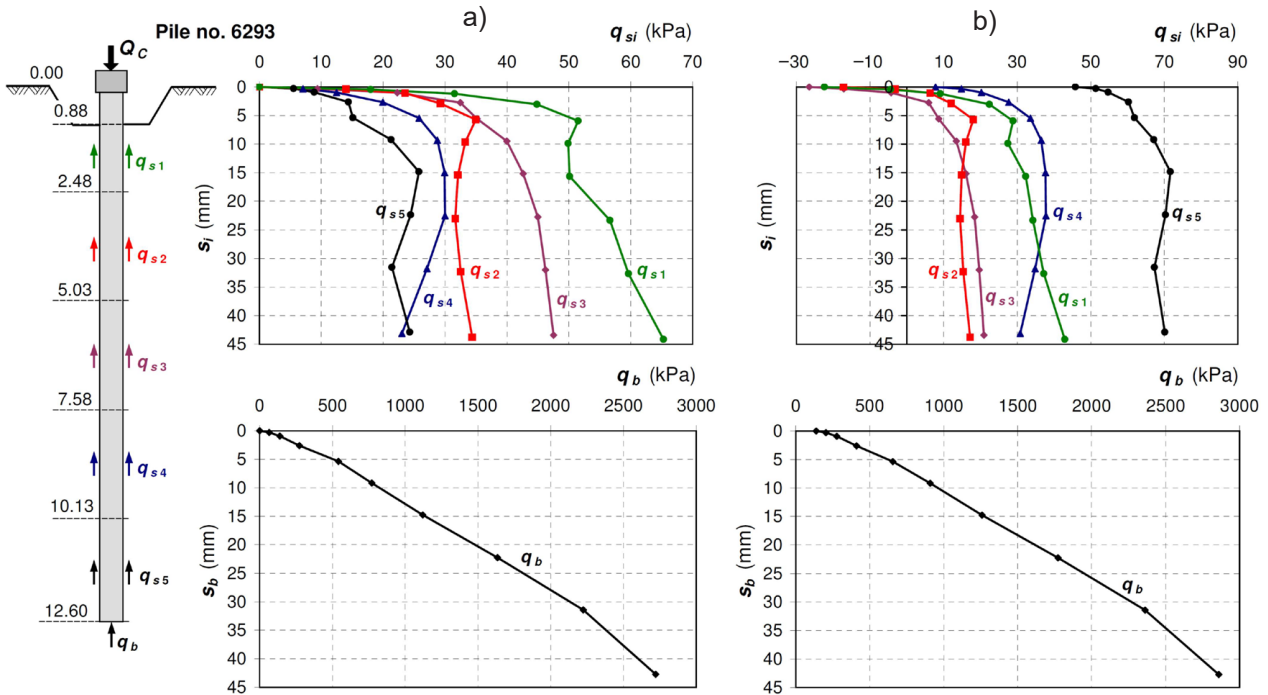
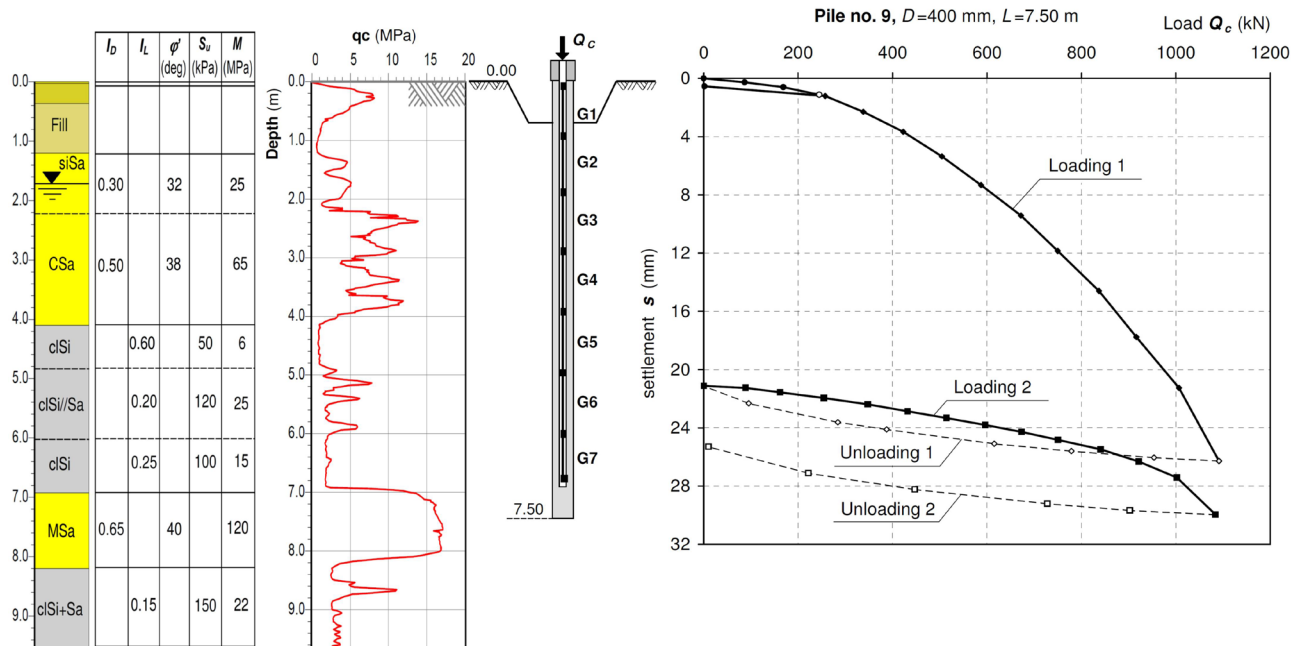

Figure 10: Pile no. 6293, comparison of q_s and q_b unit soil resistances around the pile for the cases: a) without taking into account the residual force and b) taking into account the residual force



about 2700 to 2850 kPa. When confronting the presented interpretation results from both stages with the results of CPTu probing, it should be stated that more reliable and realistic values of the q_s and q_b resistances were obtained in the second stage (after taking the residual force into account).

5.2 Example 2 – pile no. 9

Pile no. 9, with a diameter of $D = 400$ mm and a length of $L = 7.5$ m, was also made using a DPDT auger at a research field located near the city of Elbląg. The pile was similarly made of C25/30 concrete reinforced with 6 ribbed bars $\varnothing 16$ mm. The subsoil was mostly composed of normally consolidated cohesive soils. The result of CPTu sounding performed exactly at the pile location, together with soil classification and basic geotechnical parameters are shown in Fig. 11. This figure also shows pile instrumentation and basic result of the load test in the form of Q_c -s graph. In this case, apart from the main load and unloading, the pile was also reloaded and unloaded. Pile shaft deformation measurements during the load test are presented in Fig. 12. Test results and extensometric measurements were subjected to a similar interpretation procedure as in example 1, consisting of the first stage, omitting the influence of the residual force Q_{res} , and the second stage, first identifying the value of the Q_{res} force and then taking it into account in further analyses. When

determining the Q_{res} value, the measurements taken during the repeated loading and unloading of the pile were also taken into consideration, as shown in Fig. 16. The stress–strain relationship in the first section was used to determine the load distribution, which is presented in Fig. 13. After the analysis, it was found that the result at the measuring point G3 required correction, which consisted in adopting its value from linear interpolation within the points G2 and G4. The obtained interpretation results, as in example 1, are presented in Figs 14–18.

When analysing the interpretation results of the considered example no. 2, it should be noted that the value of the Q_{res} force was twice lower, amounting to less than 90 kN (at the G6 measurement point) than in example no. 1. This can be explained by shorter length of the pile and the difference in subsoil condition – lack of organic soils in example no. 2. Another statement is that reloading and unloading of the pile turned out to be a beneficial procedure. In general, it was observed that after the completion of the load test, the pile shaft was significantly relaxed, and thus, it was possible to estimate the force Q_{res} . This is due to the breach (weakening) of the pile skin contact with the soil and a significant elimination of negative friction acting before the pile was loaded. Carrying out another loading–unloading loop causes further weakening of this contact and, consequently, further relaxation of the pile. It can be assumed that after several such cycles, the pile shaft would fully relax, and

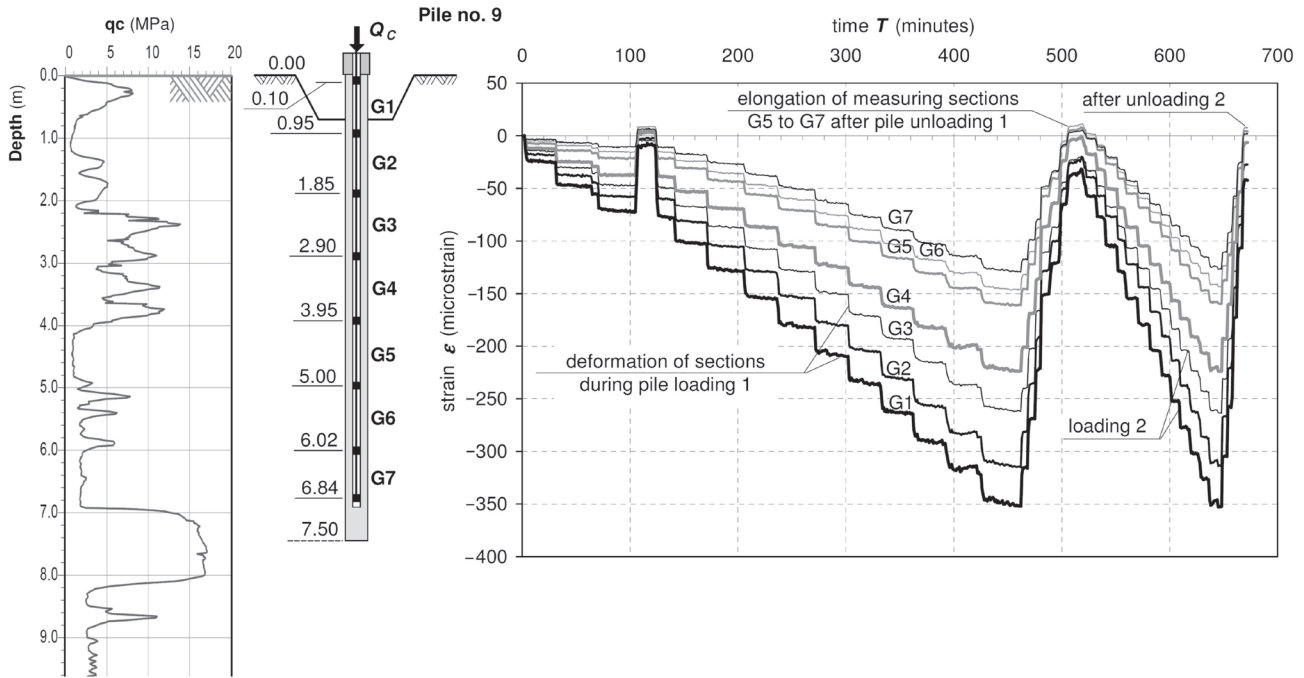

Figure 12: Pile no. 9, graphs of the pile shaft deformation in individual measuring sections and in subsequent stages of pile loading and unloading.

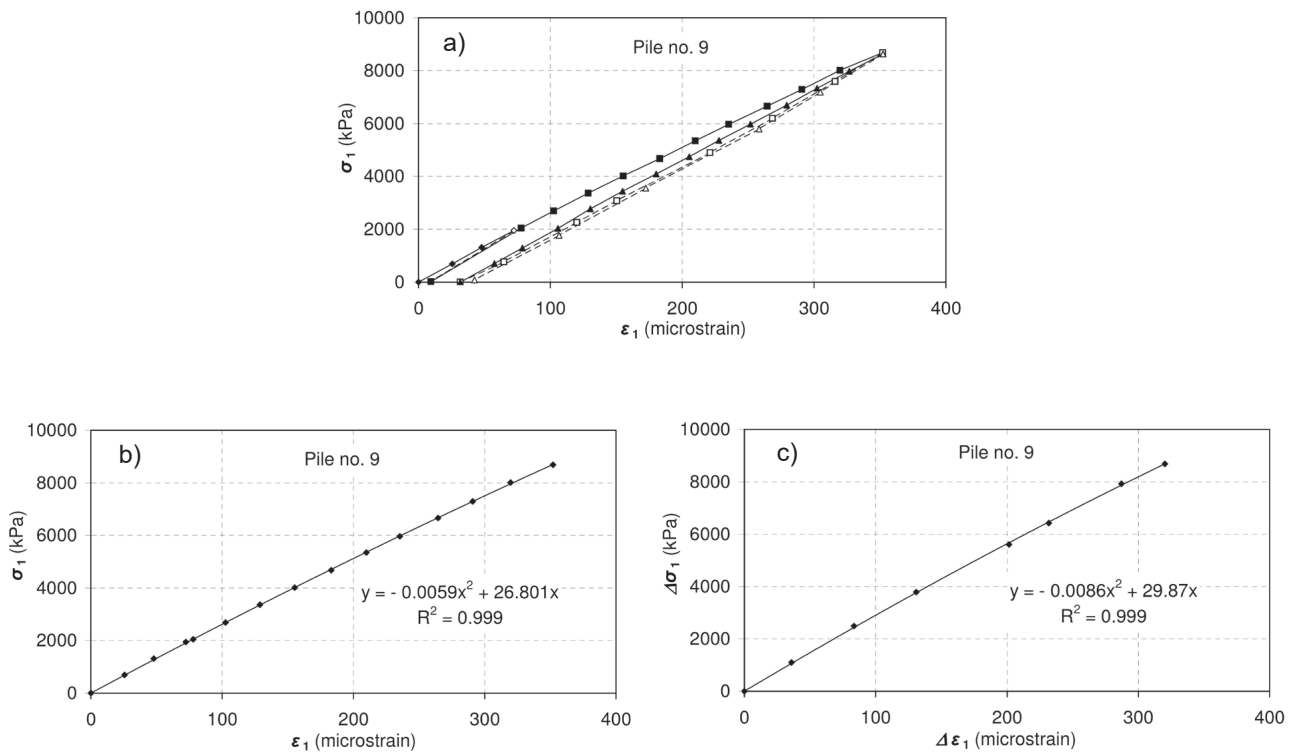

Figure 13: Stress–strain relation in the pile shaft determined in the first measuring section: a) general for load and unload; b) for load 1, described by a function and c) for unload 1, described by a function.

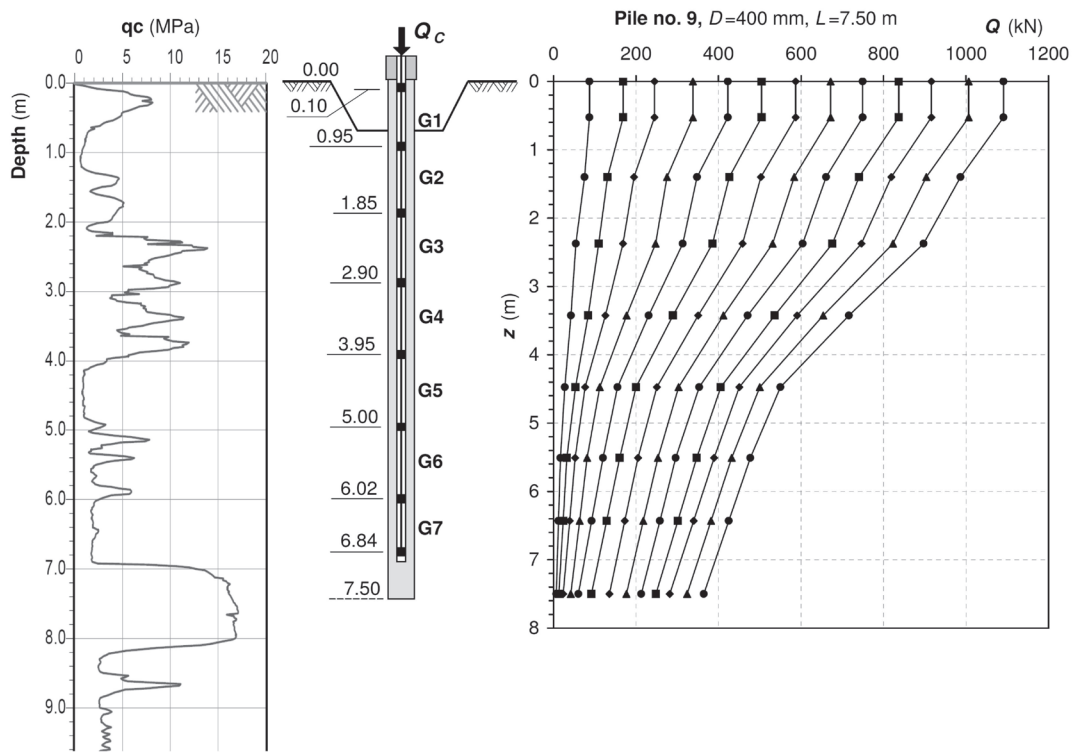

Figure 14: Pile no. 9. Axial load distribution along the pile shaft without taking into account the influence of the residual force.

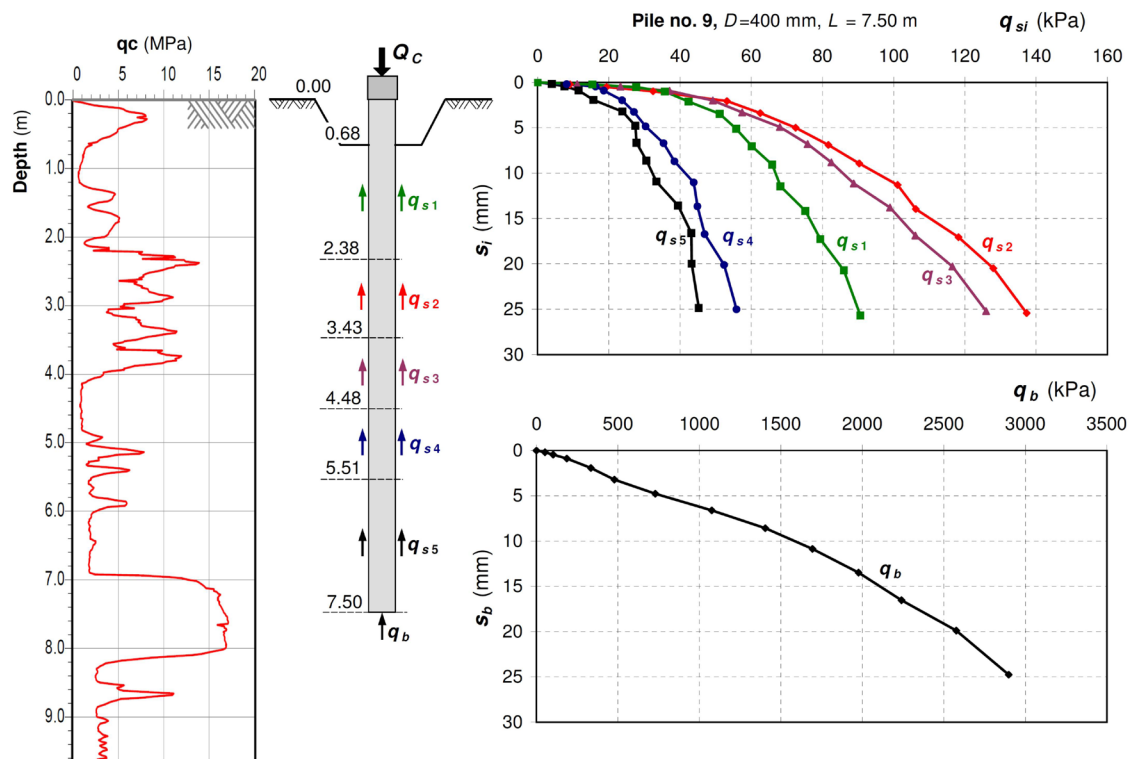

Figure 15: Pile no. 9, interpretation of q_s and q_b unit soil resistances around the pile without taking into account the influence of the residual force.

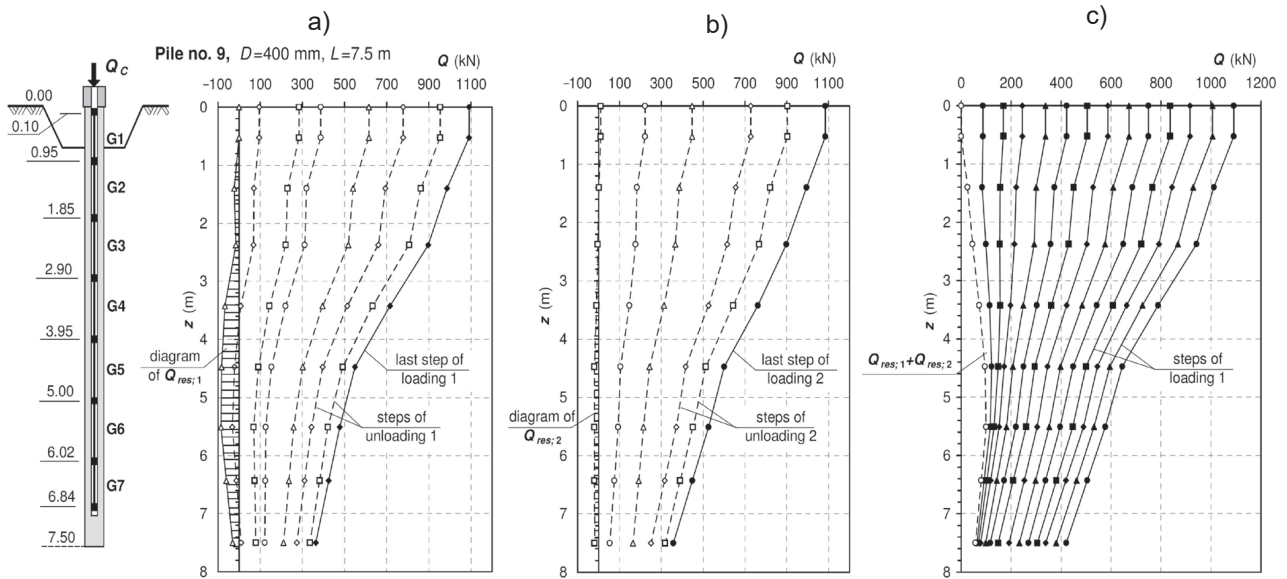

Figure 16: Pile no. 9, determination of the residual force in the pile shaft (a) after first unloading (b) after second unloading and (c) its inclusion in the distribution of the axial force along the pile in successive load steps.

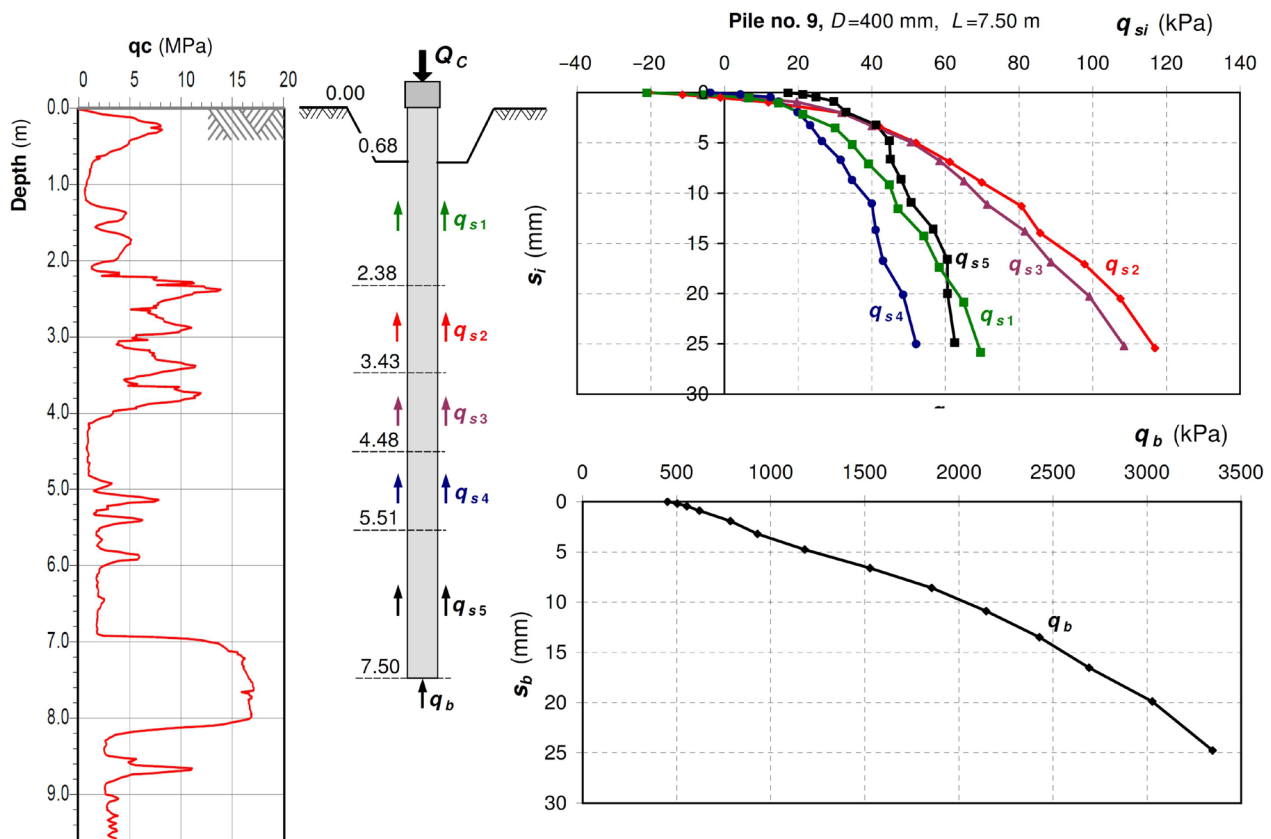

Figure 17: Pile no. 9, interpretation of q_s and q_b unit soil resistances around the pile after taking the residual force into account.

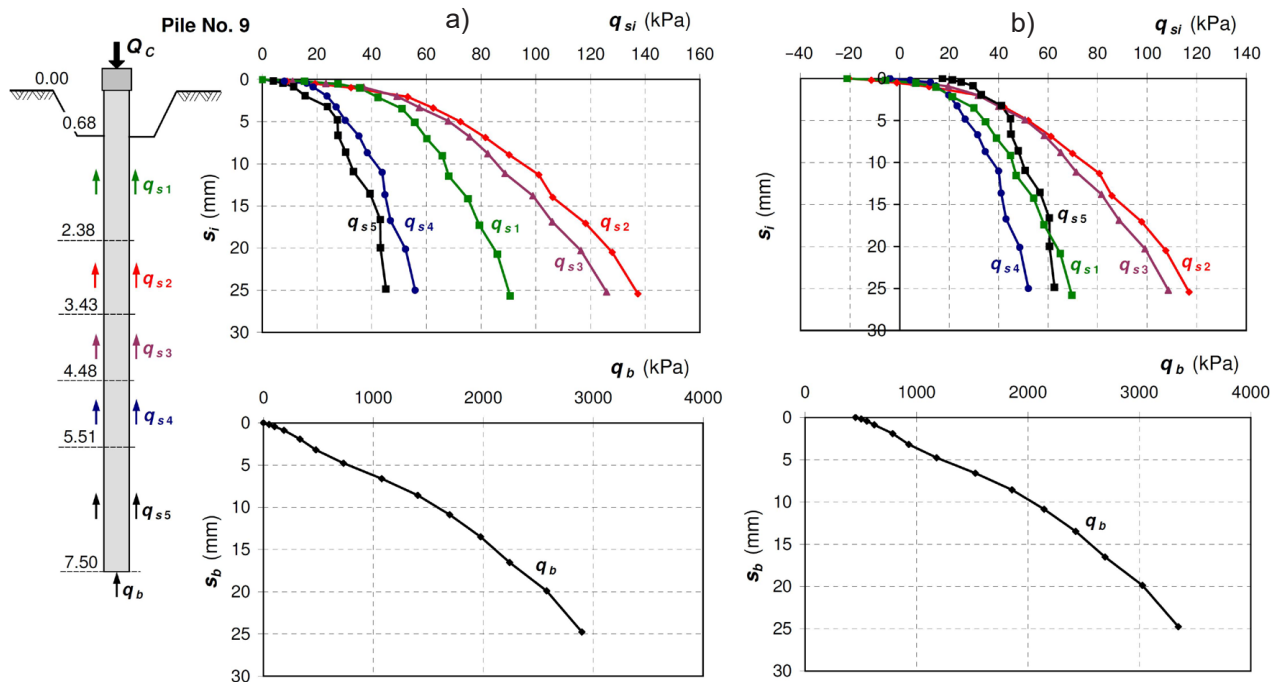

Figure 18: Pile no. 9, comparison of q_s and q_b unit soil resistances around the pile for the cases: a) without taking into account the residual force and b) taking into account the residual force.

thus, the residual force would be reduced to a value close to zero.

The comparison presented in Fig. 18 shows regularity similar to that observed in example no. 1. Taking the residual force Q_{res} into account during interpretation resulted in a decrease of frictional resistance values in the upper measurement sections (q_{s1} to q_{s3}) and an increase in the lower sections (q_{s5}). These changes are not as significant as in example no. 1 due to lower value of the force Q_{res} . However, the resistance values of q_{s5} increased from about 45 kPa in the first stage to over 60 kPa in the second stage. Differences larger than in example no. 1 were observed in the resistances q_b under the pile base. The maximum value of q_b increased from about 2900 kPa in the first stage to about 3350 kPa in the second stage. Similar to example 1, when referring to CPTu probing, it should be stated that the values of q_s and q_b obtained after taking into account the residual force (in the second stage) seem to be closer to realistic values.

6 Conclusions

The example cases and analyses presented in the article show that the presence of the residual force Q_{res} , trapped in the pile shaft before the static load test, significantly

influences the results of extensometric measurements and their interpretation. Disregarding this influence leads to false values of frictional resistance of the soil along the shaft surface – understated in the lower layers of soil (usually load-bearing) and overestimated in the upper layers of soil (usually of low bearing capacity). The soil resistance under the pile base is also lowered.

The proposed method (procedure) of identifying and estimating the value of residual force in instrumented piles is, according to the authors, very clear and easy to apply. It is based on shaft deformation changes measured during pile unloading. The observed length increase in some of the pile measuring sections is a clear evidence of the residual force presence in the pile before the loading test. The advantage of this method is also the fact that it takes into account non-linear stiffness characteristics and plastic (permanent) deformations of the concrete pile.

The discussed method has been applied to screw displacement piles, in which the presence of residual force is a common phenomenon and where a measurement system built of retrievable vibrating wire extensometers performing section readings was used. Nevertheless, it can also be applied to piles of other technologies, if only relaxation (elongation) of their shafts after unloading is observed in the measurements. Residual forces may also occur in bored piles, especially with injection under the

base and in driven piles. The method is also suitable for other measurement systems, for example, optical fibres.

In order to increase the accuracy of residual force identification, it is advisable to perform one or more additional load–unload loops besides the standard load and unload cycle.

In the case of no elongation of the measuring sections after unloading the pile or obtaining relatively low values of the residual force, its influence may be ignored in the interpretation of the pile test results.

The dissemination of the residual force identification method in combination with good solutions to other measurement problems (listed in the first paragraph) will undoubtedly increase the quality and credibility of the results of static load tests on instrumented piles and restore their attractiveness and popularity.

Acknowledgements: Piles and load tests were carried out in cooperation with a geotechnical company Budokop Sp. z o.o. from Elbląg as a part of ‘DPDT Auger’ project financially supported by the Polish National Centre for Research and Development (project no. POIR 4.1.4. 0124/18). Additional pile instrumentation, taking measurements and the residual force analyses were performed as a task in the Polish National Science Center project no. 2017/27/N/ST8/02179.

References

- [1] Cooke R.W. (1979). Influence of residual installations forces on the stress transfer and settlement under working loads of jacked and bored piles in cohesive soils. Behaviour of deep foundations. *American Society for Testing and Materials*, 231-249.
- [2] Fellenius B.H., Brusey W.G., Pepe F. (2000). Soil set-up, variable concrete modulus and residual load for tapered instrumented pile in sand. *ASCE Specialty Conference on Performance Confirmation of Constructed Geotechnical Facilities, ASCE GSP*, 94.
- [3] Fellenius B.H. (2001). From strain measurements to load in an instrumented pile. *Geotechnical New Magazine*, 96, 1629-1653.
- [4] Fellenius B.H. (2002a). Determining the Resistance Distribution in Piles. Part 1: Notes on Shift of No-Load Reading and Residual Load. *Geotechnical News Magazine*, 20(2), 35-38.
- [5] Fellenius B.H. (2002b). Determining the Resistance Distribution in Piles. Part 2: Method for Determining the Residual Load. *Geotechnical News Magazine*, 20(3), 25-29.
- [6] Fellenius B.H. (2002c). Determining the true distribution of load in instrumented piles. *ASCE Int. Deep Foundation Congress, Orlando, USA*.
- [7] Fellenius B.H. (2015). Static tests on instrumented piles affected by residual load. *Journal of the Deep Foundation Institute*, 9(1), 11-20.
- [8] Fellenius B.H. (1989). Tangent modulus of piles determined from strain data. *The ASCE Geotechnical Engineering Division, Foundation Congress*, 1, 500-510.
- [9] Hayes J., Simmonds T. (2002). Interpreting strain measurements from load tests in bored piles. *Conf Proc. Conference on Piling and Deep Foundations, Nice, France*.
- [10] Kania J.G., Sørensen K.K. (2018). A Static Pile Load Test on a Bored Pile Instrumented with Distributed Fibre Optic Sensors. *Conf Proc. 10th International Symposium On Field Measurements In Geomechanics. Rio de Janeiro, Brazil*.
- [11] Kania J.G., Sørensen K.K., Fellenius B.H. (2020). Analysis of a Static Loading Test on an Instrumented Cased CFA Pile in Silt and Sand. *International Journal of Geoenvironment Case Histories*, 5(3), 170-181.
- [12] Kim M.G., Cavusoglu E., O'Neill M.W., Robert T., Yin S. (2004). Residual Load Development in ACIP piles in a Bridge Foundation. *Conf Proc. GeoSupport, Orlando, USA*.
- [13] Krasieński A. (2012). Problematyka interpretacji pomiarów rozkładu siły osiowej w trzonie pala podczas próbnych obciążeń statycznych (Interpretation problems of the distribution of axial force in the piles during static load tests), *Inżynieria Morska i Geotechnika*, 2, 118-124.
- [14] Lunne, T., Robertson, P.K., Powell, J.J.M. (1997). Cone penetration testing in geotechnical practice. Blackie Academic, EF Spon/Taylor & Francis Publ., New York, 1997, 312 pp.
- [15] Maertens J., Huybrechts N. (2003). Belgian screw pile technology. Design and recent developments. *Swets & Zeitlinger*.
- [16] Robertson, P.K. (1990). Soil classification using the cone penetration test. *Canadian Geotechnical Journal*, 27(1): 151-158.
- [17] Sahajda K. (2015). Siły rezydualne w ocenie nośności i osiadań żelbetowych pali wbijanych (Residual forces in the assessment of bearing capacity and settlement of reinforced concrete driven piles), *PhD Thesis. Warsaw University of Technology, Poland*.
- [18] Siegel T.C., McGillivray A. (2010). Interpreted residual load in an augered cast-in-place pile. *Conf Proc. 35th Annual DFI Conference. Hollywood, USA*.
- [19] Sieńko R., Zych M., Bednarski Ł., Howiacki T. (2019). Strain and crack analysis within concrete members using distributed fibre optic sensors. *Structural Health Monitoring*, 18(5-6), 1510-1526.
- [20] Van Impe P.O., Van Impe W.F., Semmin L. (2013). Results of an instrumented screw pile load test and connected pile-group load-settlement behavior. *Journal of Geo-Engineering Sciences*, 1(1), 13-36.