

Research Paper

Acoustic Emission as a Method for Analyzing Changes and Detecting Damage in Composite Materials During Loading

Katarzyna PANASIUK^{(1)*}, Krzysztof DUDZIK⁽²⁾, Grzegorz HAJDUKIEWICZ⁽¹⁾⁽¹⁾ *Gdynia Maritime University, Faculty of Marine Engineering, Department of Engineering Sciences*
Gdynia, Poland

*Corresponding Author e-mail: k.panasiuk@wm.umg.edu.pl

⁽²⁾ *Gdynia Maritime University, Faculty of Marine Engineering, Marine Maintenance Department*
Gdynia, Poland

(received August 26, 2020; accepted February 18, 2021)

Thanks to their excellent strength and durability, composite materials are used to manufacture many important structural elements. In the face of their extensive use, it is crucial to seek suitable methods for monitoring damages and locating their origins. The purpose of the article was to verify the possibility of applying the acoustic emissions (AE) method in the detection of damages in the structures of composite materials. The experimental part comprised static tensile tests carried out on various sandwich composites, including simultaneous registration of elastic waves with increasing loads, carried out with the use of an acoustic-electrical sensor connected. The signal obtained from the sensor was then further processed and used to draw up diagrams of the AE hits, amplitude, root mean square of the AE source signal (RMS) and duration in the function of time. These diagrams were then applied on their corresponding stretching curves, the obtained charts were analysed. The results obtained point to a conclusion that the acoustic emissions method can be successfully used to detect and locate composite material damages.

Keywords: multilayered composite; recycling; mechanical properties; acoustic emission.



Copyright © 2021 K. Panasiuk *et al.*
This is an open-access article distributed under the terms of the Creative Commons Attribution-ShareAlike 4.0 International (CC BY-SA 4.0 <https://creativecommons.org/licenses/by-sa/4.0/>) which permits use, distribution, and reproduction in any medium, provided that the article is properly cited, the use is non-commercial, and no modifications or adaptations are made.

1. Introduction

Composites with reinforcements in the form of fibres are innovative materials used in structures, in which strength and relatively low weight of the material are of utmost importance. The strength of composites can be directionally shaped, which increases their attractiveness as a structural material. In turn, anisotropy hinders the design process, which applies to the tested and described glass polyester laminates, in which maximum strength directions do not always match the main axes of structural section loads.

Compared to other materials, such as steel or aluminium alloys, the process of composite cracking is much more complex. The material destruction process assumes a series of complex mechanisms, such as: cracking at the fibre-resin joint, laminate layer cracking, delamination (NIKBAKHT *et al.*, 2017; SAEEDIFAR

et al., 2016), fibre separation from the warp and cracking of fibres (MOHAMMADI, 2017).

The properties of composite materials are affected by their structure and the distribution of its individual elements. Furthermore, the defects created at the stage of manufacture and use, their amount, shape, dimensions and distribution also have great impact. In the process of manufacturing composite materials, bubbles, cavities and foliations are formed and fibres get damaged. These defects can appear, among others, due to different thermal expansion properties of their ingredients, and due to different methods of obtaining composites (GOŁASKI, 1994).

Since the use of composites in construction has become widespread, a need arose to monitor changes that take place in their structures during use (SHM – Structural Health Monitoring). Design of materials and testing techniques have evolved, shifting the focus

to durability, strength and resilience of these materials (AGGELIS *et al.*, 2012; DUDZIK, LABUDA, 2020). There are several methods of detecting damaged areas in composite materials (KURZYDŁOWSKI *et al.*, 2005; YU *et al.*, 2006; MCCRORY *et al.*, 2005). SHM describes a method of continuous monitoring of their structure to detect damages by placing sensors on the structure tested, either temporarily or permanently (CAESARENDRA *et al.*, 2016; HOŁA, 1999). Acoustic emission (AE) has the capacity of an effective SHM system used to detect damages (AL-JUMAILI *et al.*, 2016; DE ROSA *et al.*, 2009; MAREC *et al.*, 2008; RANACHOWSKI *et al.*, 2012). The method is based on recording flexible waves which result from such phenomena as external loads, ambient conditions, internal stress. These events can be detected on the surface of the structure, using piezoelectric sensors. In composite structures, wave speed is rarely constant due to changes in thickness and anisotropy, where wave speed depends on the direction of propagation, and is much higher in the vicinity of a fibre bundle. The measurements of these impulses can be an ideal method of monitoring composite destruction processes (GUTKIN *et al.*, 2011; MONTI *et al.*, 2016), testing local damages, detecting faults and internal defects and structural transformations (XIAO *et al.*, 2016). Information contained in courses, such as amplitude, frequency and duration, can present a complete image of changes taking part in composite materials throughout their use (XINGMIN, XIONG, 2006). The AE technique is a real and effective tool used to identify damaging mechanism, such as fiber warp removal, warp cracking and defibering (PANASIUK, HAJDUKIEWICZ, 2017; PANASIUK *et al.*, 2019; KYZIOŁ *et al.*, 2020).

The article describes static tensile tests carried out on glass polyester laminates with and without recycle content, with simultaneous recording of acoustic signals generated by samples under increasing loads. The impact of glass polyester waste used in the composite on the level of acoustic signal generated from structures being destroyed was determined in the test. The images of tested composite material structures were compared.

2. Methodology

A fragment of glass polyester scrap obtained from vessels built in the 1980s was sourced to determine the recyclability of composite materials. The scrap was pre-crushed with a hammer, and then ground on a dedicated plastics processing station (a mill). Crushed, the waste was sieved on a screen with an eye size of 1.2 mm to obtain the recycle used as a filler added to the warp of a newly produced glass polyester composite. The average size of the recycle was ≤ 1.2 mm.

After a recycle of the right grain size was produced, the next step was to prepare the compos-

ite panels. Laminate was produced using the hand-lamination contact method, using a mat as reinforcement. POLIMAL 1094 AWTP polyester resin manufactured by “Organika-Sarzyna” S.A. with a hardener and a booster recommended by the resin manufacturer was used as warp for all of the above mentioned materials. A long-fibre, weaved glass mat of 300 g/m² in grain size serves as reinforcement. In Table 1, there are presented the properties of polyester resin and fiberglass used in the manufacturing process (Organika Sarzyna, 2020).

Table 1. Properties of polyester resin and fiberglass used in the manufacturing process (Organika Sarzyna, 2020).

| | Ultimate tensile strength, R_m [MPa] | Young modulus, E [GPa] | Strain, ε [%] |
|-----------------|--|------------------------|---------------------------|
| Fiberglass | 2900 | 73.5 | 3.37 |
| Polyester resin | 70 | 4.3 | 2 |

Panels with different glass polyester waste contents, 0% and 10%, were produced (PANASIUK, HAJDUKIEWICZ, 2017; KYZIOŁ *et al.*, 2020). In Table 2, there are presented the percentage of the warp, reinforcement and recycle in the composite material.

Table 2. The average percentage of the warp, reinforcement and recycle in the composite material.

| | Fiberglass [% by weight] | Polyester resin [% by weight] | Recyclate [% by weight] |
|---------------------|--------------------------|-------------------------------|-------------------------|
| 0%, without recycle | 65 | 35 | 0 |
| 10%, ≤ 1.2 mm | 65 | 25 | 10 |

To use the composite material produced in static tensile testing, samples were prepared according to PN-EN ISO 527-4_2000P and were carried out in accordance with the current standard. Composite panel samples were produced using the water-jet cutting method. The method guarantees that similar sizes are obtained for each of the samples. Figures 1 and 2 present composite structures without waste content and with a 10% glass polyester recycle content before the test, presenting the defects obtained in the production process in the form of air pores. Figure 3 presents the view of specimens used in research.

The research was carried out at the universal hydraulic testing machine Zwick & Roell MPMD P10B with TestXpert II software. Additionally, Epsilon 3542 extensometer was used for measuring elongation during test.

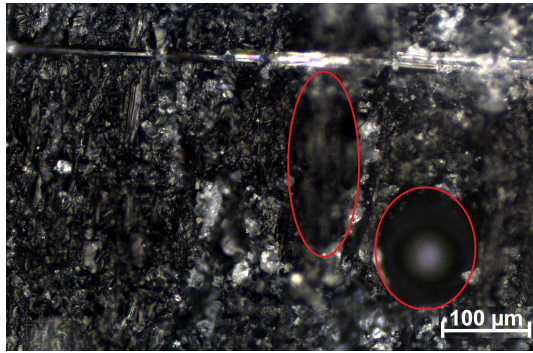

Fig. 1. A photograph of the composite structure without any glass polyester waste content, with defects marked, taken with an optical microscope.

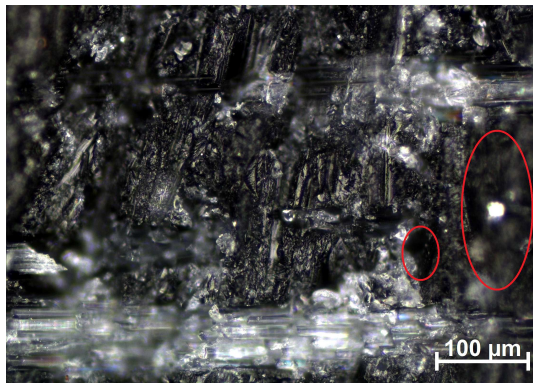

Fig. 2. A photograph of the composite structure with a 10% glass polyester waste content (≤ 1.2 mm grain size), with defects marked, taken with an optical microscope.

a)



b)



Fig. 3. View of specimens used in research: a) composite without recycle, b) composite with 10% of recycle.

For monitoring tensile test of chosen specimens Physical Acoustics Company (PAC) acoustic emission

system was used. Diagram of the measuring station is presented in Fig. 4.

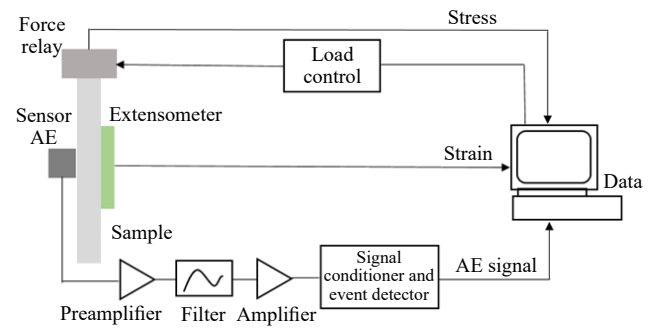

Fig. 4. Diagram of the measuring station.

Research AE was performed using set consisted of: single channel recorder USB AE Node, type 1283 with bandpass 20 kHz – 1 MHz, preamplifier with bandpass 75 kHz – 1.1 MHz, AE-Sensor VS 150M (with a frequency range of 100–450 kHz), computer with AE Win for USB Version E5.30 software for recording and analysing AE data. The tests were carried out in accordance with the applicable standards related to acoustic emission tests (PN-EN 1330-9:2017-09; PN-EN 13554:2011E; PN-EN 15857:2010E).

Between the sensor and a surface of the specimen a coupling fluid was used. AE Sensor was fixed to specimen by elastic tape.

3. Test results

During the study, the AE generated by internal friction, cracking of warp and fibers inside the sample, carried out on a test stand, recorded a number of parameters which were analyzed. Significant changes of selected parameters of AE signals were characterized with hits with duration above 30 μ s. Only those parameters for which this condition was met were selected for the analysis. These parameters were e.g.: amplitude, hits, RMS (root mean square of the AE source signal) and duration and are shown in Fig. 5 (ZAKI *et al.*, 2015).

The analysis of that parameters was made using AE Win for USB Version E5.30 software. The results obtained during the tests, such as the root mean square of the AE source signal (AE RMS), amplitude, wavelength, as well as the number of hits for material without recycle and with recycle were combined with each other for comparison. The first of the parameters analyzed is the number of events (AE hits). It gives the information how many sources of acoustic emission signals occur during loading, which are caused by the damage that occurs in it, such as: cracking of warp and fibers inside the specimen, delamination as a result of the addition of recycle, cracking at the fiber-warp border.

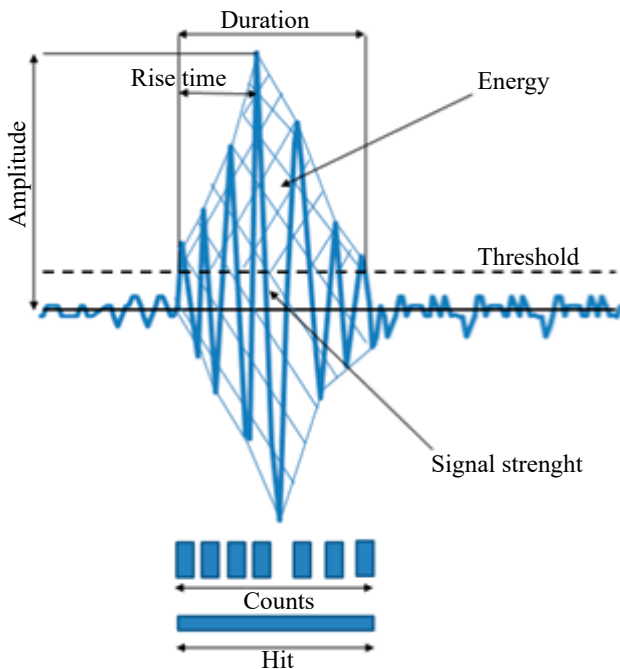

Fig. 5. Parameters reflecting of an AE waveform (ZAKI *et al.*, 2015).

Figure 6 presents a graph of stress and the number of acoustic emission hits as a function of time for material without recycle.

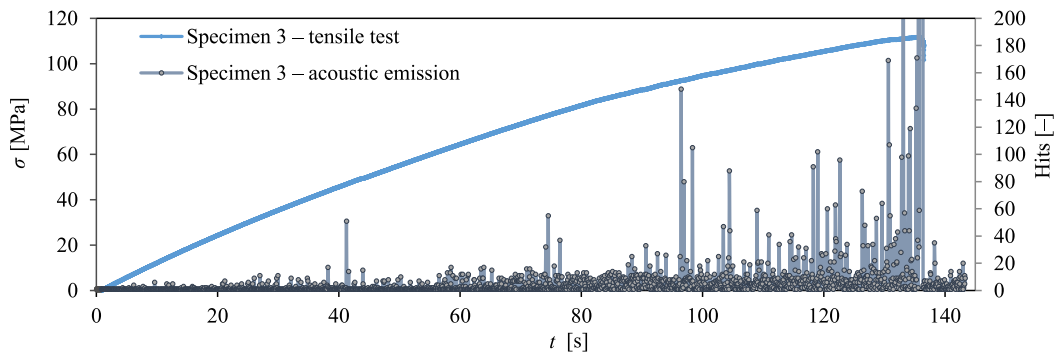

Fig. 6. Graph of stress and number of AE hits, as a function of time for a selected sample without recycle.

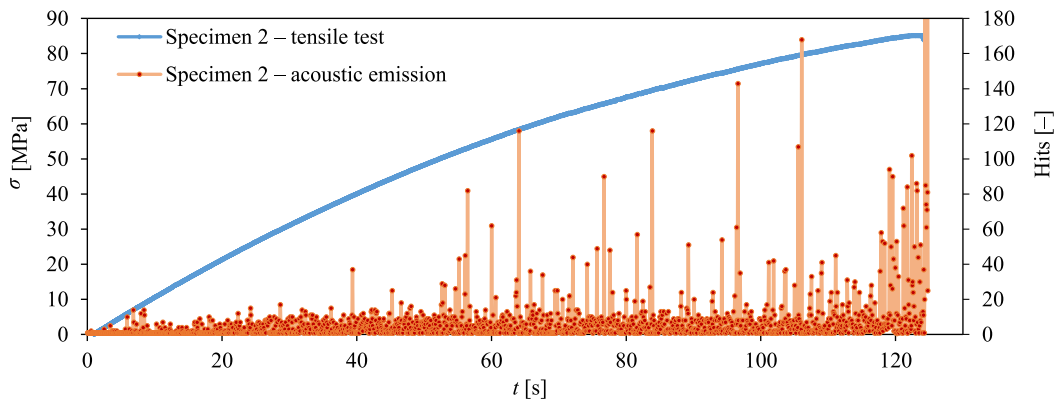

Fig. 7. Graph of stress and number of AE hits as a function of time for a selected sample with 10% recycle content.

Figure 7 presents a graph of stress and the number of acoustic emission hits for a selected sample with 10% polyester-glass recycle.

Figure 8 presents a graph of stress and amplitude of the acoustic emission signal as a function of time and a marked threshold of 45 dB.

Figure 9 presents a graph of stress and amplitude as a function of time, with a set threshold of 45 dB, as in the case of material without recycle.

Figure 10 shows samples without recycle and with 10% recycle content after static tensile test.

Figure 11 shows the stress and RMS graph as a function of time for non-recycle material.

Figure 11 presents a graph showing the RMS of the acoustic emission signal as a function of time, indicating that small changes occur at the beginning of loading. At approx. 60 s, corresponding to a value of 60 MPa, a higher effective value appears. The highest RMS signal value was recorded at maximum strength, corresponding to sample destruction.

Figure 12 presents a stress and RMS graph as a function of time for a sample with 10% recycle content.

Table 3 presents the results obtained during the analysis of the acoustic emission signal during loading.

Based on the results presented in Table 3, it is possible to conclude that the use of recycle in composite materials has an impact on the parameters of acoustic

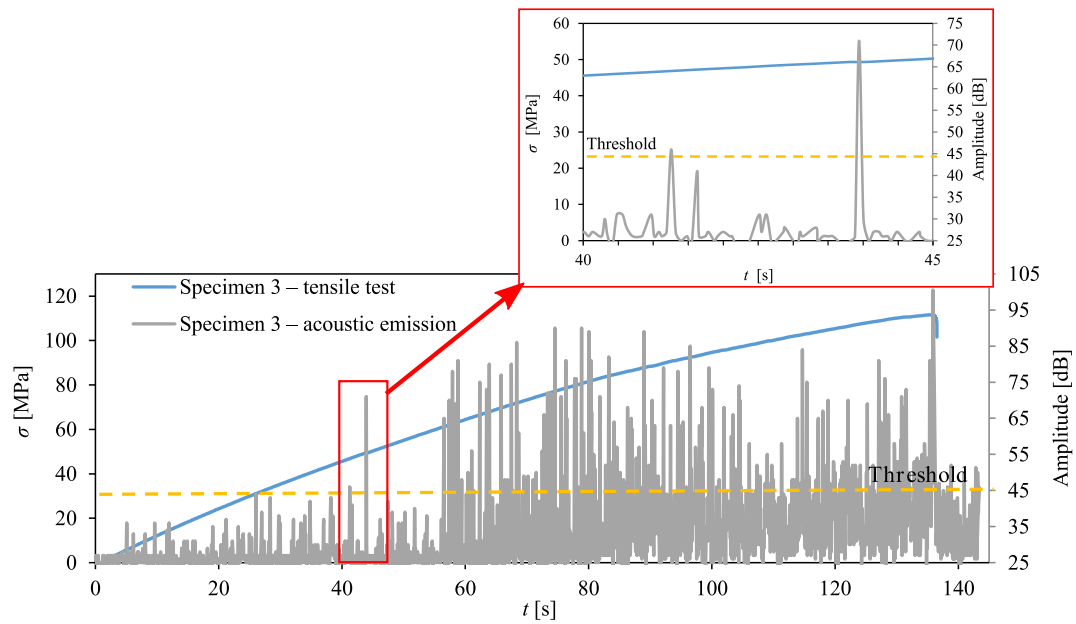

Fig. 8. Graph of stress and amplitude of acoustic emission signals as a function of time for a sample without recycle.

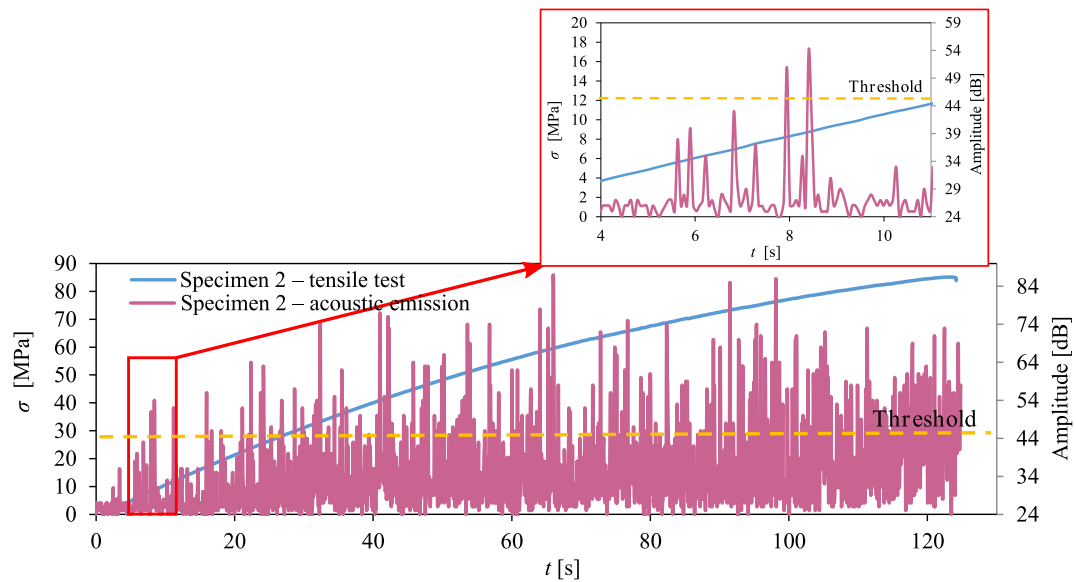

Fig. 9. Graph of stress and amplitude of acoustic emission signals as a function of time for a sample with 10% polyester-glass recycle content.

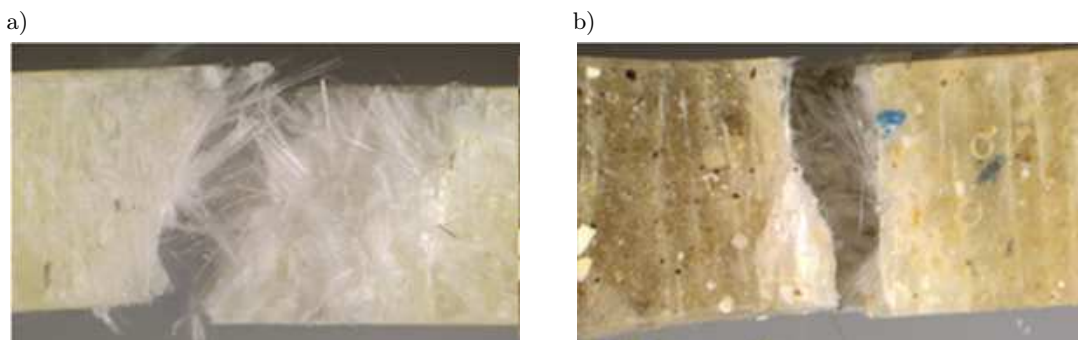

Fig. 10. Samples after static tensile testing:
 a) sample without recycle, b) sample with 10% recycle content.

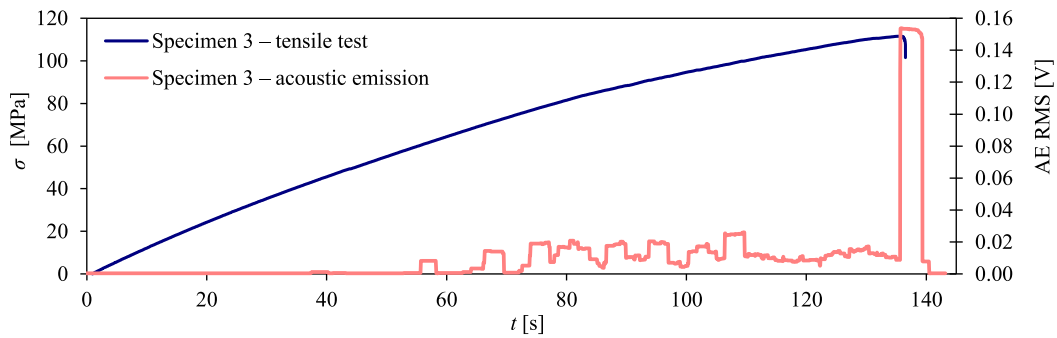

Fig. 11. Stress and RMS graph as a function of time for a sample without recycle.

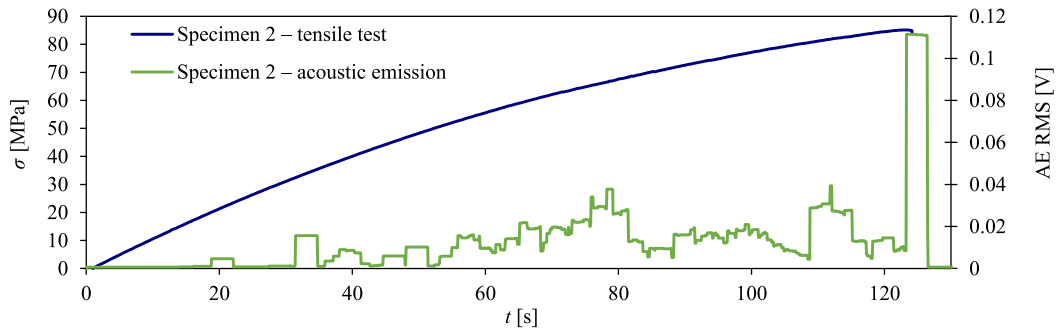

Fig. 12. Stress and RMS graph as a function of time for a sample with 10% polyester-glass recycle content.

Table 3. The results obtained during the analysis of the acoustic emission signal during loading.

| | Sum of hits [-] | Average amplitude [dB] | Average RMS [V] |
|-----------------------|-----------------|------------------------|-----------------|
| 0% recycle, sample 1 | 21 386 | 31.88 | 0.0076 |
| 0% recycle, sample 2 | 16 388 | 28.4 | 0.0097 |
| 0% recycle, sample 3 | 25 734 | 25.54 | 0.0085 |
| Average | 21 169 | 28.6 | 0.0086 |
| 10% recycle, sample 1 | 25 460 | 33.6 | 0.0103 |
| 10% recycle, sample 2 | 36 548 | 31.1 | 0.0112 |
| 10% recycle, sample 3 | 32 456 | 30.6 | 0.0106 |
| Average | 31 488 | 31.76 | 0.01107 |

emission (AE). By using 10% of waste in the composite, the hits parameter values are increased by an average of 30%. Amplitude increases by an average of 10%, and RMS 20%. Thus, the impact of waste on the increase in parameters is noticeable. It is directly related to the fact that at the time of the occurrence of standard events for composites, such as cracking of the warp, reinforcement, there is a simultaneous signal related to the response of the recycle. During the cracking of the matrix, the recycle moves, the same as when the reinforcement breaks.

4. Discussion

Analyzing the graphs of stress and number of AE hits as a function of time (Figs 6 and 7), it is concluded that by adding recycle, we notice an increase

in the number of acoustic emission signals at the very beginning of loading, compared to material without recycle. For material without recycle, a greater number of hits (40) are observed at a stress of approx. 40 MPa, similarly to material with recycle. Based on the entire loading process for samples with and without recycle, an increase in this amount is observed with composite with recycle. With composite without recycle, the increase in the number of acoustic emission signals occurs only at approx. 75 s, corresponding to a stress of approx. 80 MPa. However, in the case of a sample with 10% recycle content, the next ones occur after 50 s, corresponding to about 50 MPa. The value of the intensity parameter for the occurrence of acoustic emission signals allows the determination of a stress value typical of a material without causing major damage.

According to the literature (SHAFIQ *et al.*, 2005; JUSKOWIAK *et al.*, 2013) maximum amplitude values caused by warp fracture are within 75–90 dB. In order to obtain the values of the amplitude of the acoustic emission signals, which will be subjected to further analysis, it is necessary to separate the noise from them (Figs 8 and 9). Considering that the amplitude reaches the value of approx. 40 dB from the very beginning of loading, and there are no significant changes in the material, a value of 45 dB can be taken as the threshold.

The signal amplitude as a function of time shown in Fig. 8 takes into account all events occurring during the process of loading the sample.

Amplitude values reflect the characteristics of events occurring during material loading. Due to the fact that the material without recyclate is composed of warp and reinforcement in the form of fiberglass, the obtained amplitude values can be divided into those related to warp cracking and those with fiber cracking, as well as at the fiber-warp boundary. At high loads, the elastic wave defining warp cracking is characterized by a higher amplitude value than those associated with glass fiber cracking. Warp fracture occurs at an amplitude in the range of 76–90 dB. Hence, it can be seen that the first warp crack occurs at a stress of about 60 MPa. Further changes occurring in the material, in addition to fiber and warp, are associated with fiber-warp cracking.

Figure 9 presents the force versus time graph with the amplitude versus time graph plotted for a sample with 10% polyester-glass recyclate content. The material with 10% recyclate content is characterized by a smaller value of the amplitude of the acoustic emission signal, by replacing reinforcement, by adding recyclate to the warp. The recyclate connected to the warp, at the same time weakens it, and thereby reduces the amplitude of the acoustic emission signals caused by its breakage.

In both cases, from 45–60 dB similar elastic wave amplitudes are observed during the entire loading process, up to destruction, probably corresponding to the cracking of glass fiber, glass fiber – warp. The maximum amplitude values, on the other hand, are probably caused in both cases by warp cracking within 75–90 dB (SHAFIQ *et al.*, 2005; JUSKOWIAK *et al.*, 2013). The glass-polyester recyclate in the warp, during loading, undergoes only displacement or also affects the tearing of the fibers, probably the signal amplitude accompanying this phenomenon in relation to the fiber and warp is negligible. The maximum value of the amplitude of the acoustic emission signal, for material without recyclate, can be observed at the maximum stress value. This is due to the cracking characteristics and the development of damage in this material as a result of loading.

Based on the destruction characteristics of composite materials, it is noticeable that they are reflected in

the graphs of the amplitude of the acoustic emission signals as a function of time. In the material without recyclate, during loading, fiber stretching and cracking at the fiber-warp border occur first. It is only at higher loads that the warp begins to crack. The maximum value of the amplitude of the acoustic emission signals, appearing at the maximum load of the sample, corresponds to the total warp fracture, followed by delamination of the remaining fibers.

For non-recyclate material, the nature of the cracking is brittle. During the whole process of loading the material, warp cracking, cracking at the fiber-warp boundary occurs, and delamination. This is due to the addition of recyclate to the warp, and thus a smaller amount of reinforcement. Maximum stress already has a slight effect on changes in the material.

The graphs obtained by the acoustic emission method (Figs 11 and 12) show the relationship between the RMS of the signal as a function of time and the force acting on the sample. They reveal the occurrence of various mechanisms of destruction in the tested materials due to clear differences in the values of received signals. For samples without recyclate, the value of the root mean square of the AE source signal up to about 55 s, which corresponds to a stress of 60 MPa, does not indicate major changes in the material. Only after exceeding 55 s the effective value increase is visible. For samples with 10% recyclate content, the root mean square of the AE source signal value up to about 35 s, which corresponds to a stress of 35 MPa, does not indicate any major deviations. Only after exceeding 35 s is the deviation visible for all selected samples.

The earlier appearance of a higher AE RMS at lower stress values for samples with 10% recyclate content is closely related to the inclusion of waste in the composite structure. The addition of recyclate affects the entire process of destroying the final composite and accelerates it. Analyzing the charts for the above-mentioned materials, it is clearly seen that in the case of samples without recyclate, the deviations of the RMS of the signal are lower compared to samples with a waste content of 10%.

5. Conclusions

Determining the properties of composite materials based on their input components, such as warps or mats, is of key importance when used in constructions in the economic sense (material costs, labor consumption, time). Each composite material obtains its target properties in the manufacturing process, which can only be verified on the final product. Properties of composite materials are affected by their structure and distribution of individual elements. What's more, defects arising at the stage of production and use, their quantity, shape, dimensions and distribution also have a significant impact. In the production process of com-

posite materials, micro-stresses, air pores and fibers are damaged. Manual lamination with the contact method involves the risk of defects and their impact on the strength of these materials.

In contrast to isotropic materials, such as metals and their alloys, the analyzed process of composites destruction involves a number of phenomena. The material undergoes such changes as: cracking at the fiber-resin interface, warp cracking, delamination, separation of fibers from the warp and cracking of the fibers.

The results obtained in this article allow to evaluate which parameters, obtained as a result of tests using the acoustic emission method, have the biggest diagnostic information determining the nature of material damage during loading. During the tests, a number of parameters were obtained, such as: number of hits, amplitude, RMS of the signal. Their proper preparation as well as analysis allows to determine beginning of material destruction process. The obtained graphs of the analyzed parameters indicate that hits and RMS are the most important and showing the most information. The hits and RMS charts show the points where the number of events increases, which is synonymous with the amount of damage in the composite material. Thus, it is possible to determine up to which stress value it is possible to use such a composite in order not to damage it.

By analyzing the amount of acoustic emission hits as a function of time, we obtain information on how much damage in the form of: warp cracking, delamination, fiber cracking occurs when loading the material. The values of signal amplitude and its RMS value inform about various mechanisms of destruction in the tested materials through clear differences in the values of the received signals. Their thorough analysis allows the selection of signal characteristics that correspond to a particular type of damage.

The obtained results indicate that the acoustic emission method can be successfully used to detect structural changes in materials, which is very important in the design of structures containing composite materials, allows to obtain more information about the material. This method can be used to detect adverse changes in the early stages that can potentially lead to the destruction of the entire structure, thus contributing to economic losses.

References

1. AGGELIS D., BARKOULA N.-M., MATIKAS T., PAI-PETIS A. (2012), Acoustic structural health monitoring of composite materials: Damage identification and evaluation in cross ply laminates using acoustic emission and ultrasonics, *Composites Science and Technology*, **72**(10): 1127–1133, doi: 10.1016/j.compscitech.2011.10.011.
2. AL-JUMAILI S.K., PEARSON M.R., HOLFORD K.M., EATON M.J., PULLIN R. (2016), Acoustic emission source location in complex structures using full automatic delta T mapping technique, *Mechanical Systems and Signal Processing*, **72–73**: 513–524, doi: 10.1016/j.ymssp.2015.11.026.
3. CAESARENDRA W., KOSASIH B., TIEU A.K., ZHU H., MOODIE C.A.S., ZHU Q. (2016), Acoustic emission-based condition monitoring methods: Review and application for low speed slew bearing, *Mechanical Systems and Signal Processing*, **72–73**: 134–159, doi: 10.1016/j.ymssp.2015.10.020.
4. DE ROSA I., SANTULLI C., SARASINI F. (2009), Acoustic emission for monitoring the mechanical behaviour of natural fibre composites: A literature review, *Composites Part A: Applied Science and Manufacturing*, **40**(9): 1456–1469, doi: 10.1016/j.compositesa.2009.04.030.
5. DUDZIK K., LABUDA W. (2020), The possibility of applying acoustic emission and dynamometric methods for monitoring the turning process, *Materials (Basel)*, **13**(13): 2926, doi: 10.3390/ma13132926.
6. Gołaski L. (1994), Acoustic emission in composite materials [in Polish: Emisja akustyczna w materiałach kompozytowych], [in: Małecki J., Ranachowski Z. [Eds], *Acoustic emission. Sources. Methods. Usage* [in Polish: *Emisja akustyczna. Źródła. Metody. Zastosowania*], Warszawa: PASCAL.
7. GUTKIN R., GREEN C.J., VANGRATTANACHAI S., PINHO S.T., ROBINSON P., CURTIS P.T. (2011), On acoustic emission for failure investigation in CFRP: Pattern recognition and peak frequency analyses, *Mechanical Systems and Signal Processing*, **25**(4): 1393–1407, doi: 10.1016/j.ymssp.2010.11.014.
8. HOŁA J. (1999), Acoustic-emission investigation of failure of high strength concrete, *Archives of Acoustics*, **24**(2): 233–244.
9. JUSKOWIAK E., MAŁDACHOWSKA A., PANEK M. (2013), Acoustic emission of composite sandwich panels during three-point bending [in Polish: Emisja akustyczna kompozytowych płyt przekładkowych podczas trójpunktowego zginania], *Przetwórstwo Tworzyw*, **19**(4): 351–354.
10. KURZYDŁOWSKI K., BOCZKOWSKA A.S.J., KONOPKA K., SPYCHAŁSKI W. (2005), Monitoring of failures in the composites by non-destructive methods [in Polish: Monitorowanie uszkodzeń w kompozytach metodami nieniszczącymi], *Polymers*, **50**(4): 255–261.
11. KYZIOŁ L., PANASIUK K., BARCIKOWSKI M., HAJDUKIEWICZ G. (2020), The influence of manufacturing technology on the properties of layered composites with polyester-glass recyclate additive, *Progress in Rubber, Plastics and Recycling Technology*, **36**(1): 18–30, doi: 10.1177/1477760619895003.
12. MAREC A., THOMAS J., GUERJOURA R.E. (2008), Damage characterization of polymer-based composite

- materials: Multivariable analysis and wavelet transform for clustering acoustic emission data, *Mechanical Systems and Signal Processing*, **22**(6): 1441–1448, doi: 10.1016/j.ymsp.2007.11.029.
13. McCrory J.P. et al. (2005), Damage classification in carbon fibre composites using acoustic emission: A comparison of three techniques, *Composites: Part B*, **68**: 424–430, doi: 10.1016/j.compositesb.2014.08.046.
 14. Mohammadi R., Najafabadi M.A., Saedifar M., Yousefi J., Minak G. (2017), Correlation of acoustic emission with finite element predicted damages in open-hole tensile laminated composites, *Composites Part B: Engineering*, **118**: 427–435, doi: 10.1016/j.compositesb.2016.09.101.
 15. Monti A., El Mahi A., Jendli Z., Guillaumat L. (2016), Mechanical behaviour and damage mechanisms analysis of a flax-fibre reinforced composite by acoustic emission, *Composites Part A: Applied Science and Manufacturing*, **90**: 100–110, doi: 10.1016/j.compositesa.2016.07.002.
 16. Nikbakht M., Yousefi J., Hosseini-Toudehshky H., Minak G. (2017), Delamination evaluation of composite laminates with different interface fiber orientations using acoustic emission features and micro visualization, *Composites Part B: Engineering*, **113**: 185–196, doi: 10.1016/j.compositesb.2016.11.047.
 17. Panasiuk K., Hajdukiewicz G. (2017), Production of composites with added waste polyester-glass with their initial mechanical properties, *Scientific Journals of the Maritime University of Szczecin*, **52**(124): 30–36, doi: 10.17402/242.
 18. Panasiuk K., Kyzioł L., Dudzik K. (2019), The use of acoustic emission signal (AE) in mechanical tests, *Przegląd Elektrotechniczny*, **95**(11): 8–11, doi: 10.15199/48.2019.11.03.
 19. PN-EN ISO 527-4:2000, Plastics – Determination of mechanical properties under static stretching – Test conditions for isotropic and orthotropic fiber-reinforced plastic composites.
 20. PN-EN 1330-9:2017-09, Non-destructive testing – Terminology – Part 9: Terms used in acoustic emission testing.
 21. PN-EN 13554: 2011E, Non-destructive testing – Acoustic emission – General rules.
 22. PN-EN 15857: 2010E, Non-destructive testing – Acoustic emission – Testing of fiber-reinforced polymers – Specified methodology and general evaluation criteria.
 23. Ranachowski Z., Józwiak-Niedźwiedzka D., Brandt A., Dębowski T. (2012), Application of acoustic emission method to determine critical stress in fibre reinforced mortar beams, *Archives of Acoustics*, **37**(3): 261–268, doi: 10.2478/v10168-012-0034-3.
 24. Saedifar M., Fotouhi M., Ahmadi Najafabadi M., Hosseini Toudehshky H., Minak G. (2016), Prediction of quasi-static delamination onset and growth in laminated composites by acoustic emission, *Composites Part B: Engineering*, **85**: 113–122, doi: 10.1016/j.compositesb.2015.09.037.
 25. Shafiq B., Quispitupa A., Just F., Banos M. (2005), *Sandwich Structures 7: Advancing with Sandwich Structures and Materials: Proceedings of the 7th International Conference on Sandwich Structures, Aalborg University, Aalborg, Denmark, August 29–31, 2005*, Springer Science & Business Media, doi: 10.1007/1-4020-3848-8.
 26. Xiao Y., Qiao W., Fukuda H., Hatta H. (2016), The effect of embedded devices on structural integrity of composite laminates, *Composite Structures*, **153**: 21–29, doi: 10.1016/j.compstruct.2016.06.007.
 27. Xingmin Z., Xiong Y.I. (2006), Investigation of damage mechanisms in self-reinforced polyethylene composites by acoustic emission, *Composite Science and Technology*, **66**(3–4): 444–449, doi: 10.1016/j.compscitech.2005.07.013.
 28. Yu Y.-H., Cho J.-H., Kweon J.-H., Kim D.-H. (2006), A study on the failure detection of composite materials using an acoustic emission, *Composite Structures*, **75**(1–4): 163–169, doi: 10.1016/j.compstruct.2006.04.070.
 29. Zaki A., Chai H., Aggelis D., Alver N. (2015), Non-destructive evaluation for corrosion monitoring in concrete: a review and capability of acoustic emission technique, *Sensors*, **15**(8): 19069–19101, doi: 10.3390/s150819069.
 30. Zakłady Chemiczne „Organika Sarzyna” S.A., <http://www.krisko.lublin.pl/chemia/zywice-poliestrowe-polimal/konstrukcyjne-ogolnego-stosowania-polimal-1094-awtp-1/polimal-1094-awtp-1/polimal-1094-awtp-1-a-5-kg-1.html> (access: 20.07.2020).