



WORLD EXPERIENCE IN THE USE OF EXCESS SEWAGE SLUDGE

Kamshat Jumasheva*

Department of Ecology and Geology, Sh. Yessenov Caspian University of Technology and Engineering
Aktau 130002, Kazakhstan, kamshat.jumasheva@yu.edu.kz
 <https://orcid.org/0000-0003-0105-787X>

Samal Syrlybekkyzy*

Department of Ecology and Geology, Sh. Yessenov Caspian University of Technology and Engineering
Aktau, 130002, Kazakhstan, samal.syrlybekkyzy@yu.edu.kz
 <https://orcid.org/0000-0002-0260-0611>

Akmaral Serikbayeva

¹Department of Ecology and Geology, Sh. Yessenov Caspian University of Technology and Engineering
Aktau, 130002, Kazakhstan, akmaral.serikbayeva@yu.edu.kz
 <https://orcid.org/0000-0001-8030-8934>

Farida Nurbayeva

Department of Ecology and Geology, Sh. Yessenov Caspian University of Technology and Engineering
Aktau, 130002, Kazakhstan, farida.nurbayeva@yu.edu.kz
 <https://orcid.org/0000-0002-4051-0326>

Alexandr Kolesnikov

Department of Life Safety and Environmental Protection, M. Auezov South Kazakhstan University
Shymkent 160012, Kazakhstan, kas164@yandex.kz
 <https://orcid.org/0000-0002-8060-6234>

Zhanar Bessimbayeva

Tepke limited liability partnership, Aktau, 130000, Kazakhstan, z.h.a.n.a.r@bk.ru
 <https://orcid.org/0009-0004-5926-2985>

Zhanar Uisimbayeva

Department Ecology and life safety, M. H. Dulati Taraz Regional University, Institute of Water Management
and Labor Management, zhanara_mm@mail.ru
 <https://orcid.org/0000-0003-4481-0374>

Article history: Received 17 September 2023, Received in revised form 2 November 2023, Accepted 12 November 2023, Available online 14 November 2023.

Highlight

- Precipitation of urban wastewater poses a danger of the spread of pollutants into the environment.
- Overview of the application of urban wastewater sediments and methods of their disinfection.

Abstract

The world experience of neutralization and disposal of excess sludge of urban sewage is considered. The sludge generated during the technical treatment of municipal wastewater is dangerous, has low dehydration, the percentage of moisture is more than 96%, contains some pathogenic and organic substances, as well as heavy metals. In the Mangystau region of Aktau (Kazakhstan) at a sewage treatment plant, sewage sludge is mainly accumulated on silt sites after minimal treatment. The main directions of neutralization and disposal of excess sludge used in Asian and European countries are generalized. For example, while authors from China conducted research on ultrasonic chemical treatment of urban sludge and drying by artificial methods, authors from Europe paid more attention to the disposal of excess sludge from municipal wastewater, in the form of road surface additives, cement strength additives or modified bentonite for further use. Sewage sludge as a safe fertilizer in the national economy. Their advantages and disadvantages are shown, considering environmental and economic efficiency. The advantages of many studies can be indicated by the efficiency of the secondary use of sewage sludge, as well as a significant reduction in the area allocated for the storage of precipitation data.

The disadvantages of these studies can indicate significant economic and time costs, which are ultimately compensated by the positive results of their secondary use.

Keywords

Excess sludge; disposal; neutralization technology; sludge maps; recovery.

Introduction

Excess municipal sewage sludge, an inevitable by-product of municipal wastewater treatment, is a major issue in many countries due to its increasing volume and the impact associated with its disposal. According to a European Commission report published in 2022, 36% of excess sewage sludge available in the countries of the European Union is applied to agricultural land. In the EU countries, the problems of recycling excess sludge from urban wastewater are regulated by the Sewage Sludge Directive 86/278/EEC1. This directive allows the use of sediment in agriculture, strictly monitors the issues of reducing the negative and harmful effects on environmental components and public health. This document establishes permissible concentrations of heavy metals in sediments and in the soil where they are introduced – cadmium, copper, nickel, lead, zinc and mercury. The requirements of the sludge directive have been implemented in the legislation of all EU countries, and many of them have more stringent conditions for their use.

Despite the permissibility of applying sewage sludge to soils, many European countries use incineration methods. Sludge incineration is regulated by the EU Industrial Emissions Directive 2010/75/EU (IED), which sets fixed limits for emissions from waste incineration plants (including sewage sludge) [1]. Sludge incineration on the territory of the Republic of Kazakhstan, both separately and in combination with individual waste is not carried out. Due to the global demand for organic waste and renewable energy sources, sewage sludge can become one of the available and in-demand resources in achieving this goal. It can be used as an energy source to provide the population with energy and heat, using both traditional and new types of technologies. Also, the sediment can be used as fertilizer and land reclamation if an effective technology is used. In this case, the use of sediment is more economically rational compared to incineration, disinfection or burial. Potential environmental improvements to existing solutions include reducing greenhouse gas emissions, improving soil conditions, and reducing the use of fossil fuels. The economic potential is to compensate for the costs associated with traditional waste treatment methods. In order to achieve the goal of wastewater treatment, it is necessary to manage sewage sludge more carefully, not only during the process, but also after their removal from treatment facilities. The new strategies should fit into the trend of eco-innovations in order to fulfill the basic concept of the European Commission strategy "reduce, reuse, recycle", which is currently understood as the most preferred hierarchy of waste management. After cleaning, the sediments are a biological mixture containing organic substances (human waste, food waste), dead and living microorganisms, including pathogenic, inorganic and organic toxic pollutants (trace elements of metals, polycyclic aromatic hydrocarbons).

A certain amount of sludge is regularly recycled in the process of treatment facilities in order to optimize operations. In the case when the raw sludge at the outlet of the treatment facilities contains approximately 95-97% of water, various methods of disinfection and dehydration are necessary for their further use as a useful solid biomaterial. More modern and modernized types of technologies should ensure the processing of organic substances and reduce the potential risk, with the absence of pollutants. Sludge treatment costs account for more than 50-55% of all operating costs at wastewater treatment plants, despite the fact that sewage sludge accounts for several percent of the total volume of treated wastewater. According to the technological regulations 30.0 thousand m³/day of household, industrial and storm water wastewater are processed daily at the sewage treatment plant "Caspian zhylu arnasy" of the Mangystau region, which are supplied for cleaning by the general water disposal system, and the actual amount of sewage precipitation reaches almost 11 thousand tons/year [2].

Due to the annual increase in the population of the Mangystau region, the volume of waste generated, including excess activated sludge of urban wastewater, is also increasing. The resulting secondary sediments are divided into the following main categories: organic sediments of mineral structure and activated sludge. Before dehydration, organic sludge leads to normal fermentation or stabilization, as well as thermosetting effects. The technological scheme of preparation, processing and subsequent dewatering of organic sediments and activated sludge usually includes the following stages: preliminary pressing, dehydration, thermal drying (burning). To reduce the moisture content of the sludge, including active sludge it is pressed [3]. In Kazakhstan

with a warm climate and hot summers, natural drying can be successfully applied for their dehydration, which is currently used at wastewater treatment plants (WTP) in Aktau (Figure 1).



Figure 1. Photo of the general view of the sludge platform. *Source: Own.*

In recent years, a large number of scientific works appeared on the analysis of the experience of neutralization and disposal of excess sludge accumulated to date. China, Malaysia, India and Europe pay close attention to the problem of neutralization and disposal of excess sludge. Zhang Zongge [4], Yuanjun [5], Li Aimin [6] studied the air temperature and flow rate on the rate of sludge drying, conducted research on the effect of sludge morphology on water separating properties. Yi et al. [7], through the influence of solar dryers, studied the intensity of solar radiation. When solar drying excess sludge, there are several factors that affect the drying rate of the sludge. It was concluded that with greater exposure to solar radiation, the residual moisture content of the sediment is much less. The test results are shown in Figure 2.

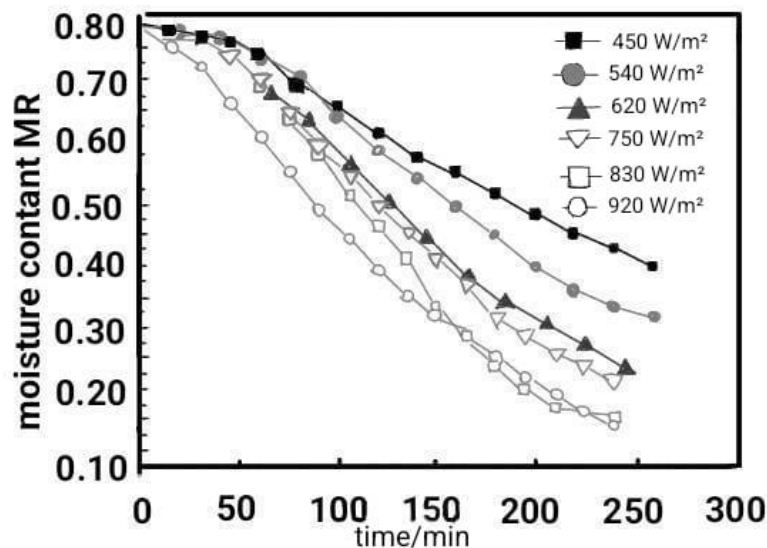

Figure 2. Changes in the water content in the sediment at different solar radiation intensity in an open solar drying system. *Source: Own.*

In this case, the results showed that the main factors in the solar greenhouse were the temperature and air humidity influencing the drying rate. There is no definite pattern between the change in drying rate and moisture content. Lei Haiyan [8,9] carried out experiments on drying excess sludge using home-made mixed solar dryers conducted a pilot study on sludge drying. The results of the experiment indicate the main factors that

influenced the drying process of the sludge. These are sediment deformation, temperature, speed and intensity of solar radiation. According to the experiments carried out on the physical and mechanical properties and chemical composition of Zabelska-Adamska [10], they indicate the possibility of using ash residues from excess sludge from municipal wastewater as a material for environmentally friendly products in civil engineering. The ash formed during the experiment indicates compliance with the norms and sanitary requirements necessary for the composition of road embankments.

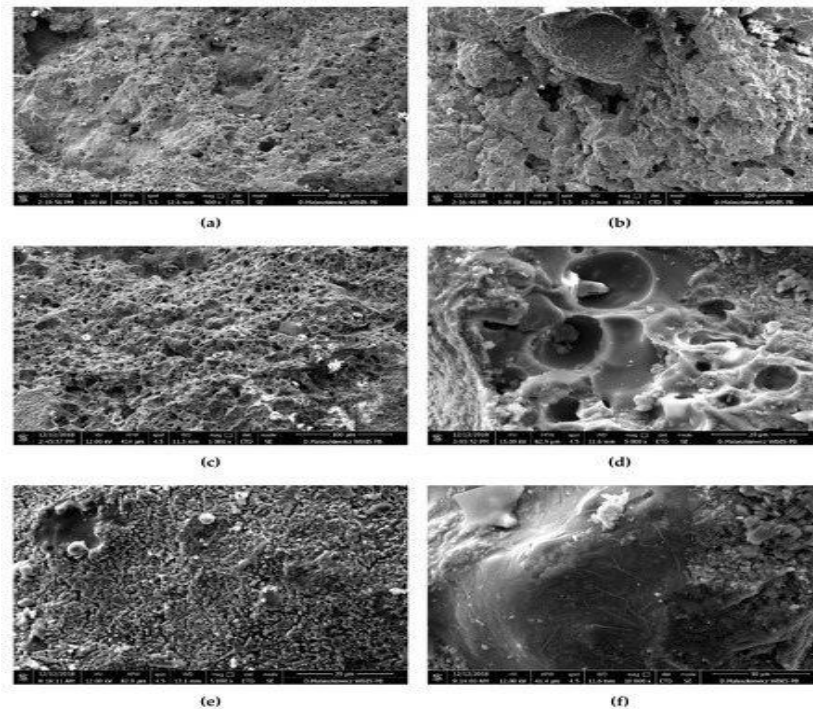

Figure 3. Images of porous sewage sludge ashes obtained on a scanning electron microscope (SEM): (a) general view of smooth and porous surface 500 \times , (b) porous natural surface 1000 \times , (c) porous fracture surface 1000 \times , (d) silica SiO₂ 5000 \times , (e) secondary hematite Fe₂O₃ 5000 \times , (f) quartz glass SiO₂. Source: Own.

Researchers pay great attention to the processes of sludge dewatering, considering the reduction of moisture content as the leading element in its disposal. Dehydration can be carried out by extensive and intensive methods. The first includes the processes of natural compaction and drying, the second – hardware methods of dehydration with additional effects on the sediment: on centrifuges, chamber and belt filter presses, gravity dehydration in geotubes [11]. According to the calculations of the manufacturer, the Geotube technology has an advantage over other methods of dehydration: the cost of sludge dehydration is 20-30% lower than with the use of apparatuses; absence of complex elements; aesthetics; absence of flooding by precipitation; the possibility of sludge dehydration, temporary storage or permanent burial at the place of its formation; low power consumption [12].

It is known that sewage sludge is an organogenic substrate containing biogenic elements (nitrogen, phosphorus, potassium, and their compounds) in concentrations comparable to traditional organic fertilizers. Therefore, both in scientific literature and in economic activity, great attention has always been paid to the issue of rational use of the biological potential of sewage sludge, its rational use. Silt sediments contain up to 40% organic and, accordingly, up to 60% mineral matter in terms of dry mass. A characteristic feature of sewage sludge is the high protein content. They also contain trace elements (heavy metals), which in adequate concentrations are vital for the development of plants, but in high concentrations they cause the toxicity of silt sediments. Heavy metals (trace elements) necessary for the growth of microorganisms can be divided into groups: elements that are usually necessary for growth (essential) — Ca, Mn, Fe, Co, Cu, Zn; elements that are rarely necessary for growth (nonessential), — Ba, Na, Al, Si, Cl, V, Cr, Ni, As, Se, Mo, Sn, I. The composition of the sludge of treatment facilities was determined based on the Method of measuring the mass concentration of heavy metals in activated sludge samples by the fluorometric method using the liquid analyzer "Fluorat- 02", M 01-26-2001, STB ISO 11885-2011. Sampaio et al. [13] says that the composted surplus sludge from municipal wastewater is an organic fertilizer that was obtained from the treatment of municipal wastewater at wastewater treatment plants. It is possible

that excess sludge from municipal wastewater contains a significant amount of potentially toxic elements and pathogenic agents (e.g., helminth eggs, protozoan cysts, *E. coli*, etc.). However, composting can significantly reduce the pathogenic load and can stabilize potentially toxic elements due to organometallic formation, so that potentially toxic elements are no longer available to plants. In addition, this method stabilizes organic matter, as a result of which the product can be safely used and classified in accordance with national and international standards as an organic fertilizer. In fact, sewage sludge contains a large amount of organic substances and plant nutrients, including nitrogen, phosphorus and trace elements. Several studies by Hernandez, Yakubus, and Florentino [14–16], reported the benefits of sediment for the physical, chemical and biological properties of the soil. Thus, Meng, et al. [17], believe that composting is a sustainable solution for companies engaged in the disposal of sludge from water treatment plants.

The Brazilian Government recently adopted Resolution No. 498/2020, Ministério da Agricultura, Pecuária e Abastecimento/Secretaria de Defesa Agropecuária. 2020 [18], which establishes rules for the use of sewage sludge in agriculture. Therefore, the introduction of sewage sludge into the soil must meet the agronomic criteria of the resolution. Accordingly, sewage sludge is considered an organic fertilizer if it complies with the standards established by the Ministry of Agriculture, Livestock and Food (MAPA), Regulatory No. 61/2020, Ministério da Agricultura, Pecuária e Abastecimento. 2020, Instrução Normativa No. 61, July 08, 2020 [19,20], which sets thresholds for pathogenic organisms and concentrations of potentially toxic elements.

Research Xu [21] showed that, at present, ultrasonic technology is widely used in the treatment of excess sludge, as it has a high decomposition rate and efficiency in use. He carried out experiments in the study areas, applying ultrasonic chemical treatment of excess sludge. An experiment using ultrasound revealed the destruction of the structure of sediment flakes and cell walls, the release of intracellular organic substances, and the acceleration of the hydrolysis process. It turned out that ultrasound is able to improve the processes of sedimentation and dehydration of sludge, and the ultrasonic wave produces a spongy effect on excess sludge. This facilitates the flow of water through the channel from the surface of the wastewater, which leads to agglomeration of the sludge particles and increases the particle size. It has also been found that ultrasound promotes the coagulation process, improves the activity of the sewage sludge and increases the efficiency of the anaerobic digestion process and the final production of biogas. The sonication process of the cationic polyacrylamide leads to a weakening of the outflow between the particles and destabilizes the sludge flock. And also, the adsorption process and the binding action of the flocculant accelerates the agglomeration of the sludge particles, while the water in the sediment is separated to be converted into free water. In this case, this improves the dewatering process and also reduces the amount of moisture in the filter cake.

The behavior of thin-layer drying of urban sewage sludge in a laboratory convective dryer with forced hot air supply using ultrasound transmitted through the air was investigated by San, et al. [22] at hot air temperatures from 70°C to 130°C. The kinetics of drying only in the convective process was compared with the kinetics of the process using ultrasound at three ultrasound powers (30, 90, 150 Watts). Average drying speeds over the entire drying temperature range at ultrasound power of 30, 90 and 150 W increased by about 22.6%, 27.8% and 32.2% compared with convective drying alone (without ultrasound). As the temperature increased from 70°C to 130°C, the maximum increase in the coefficients of effective diffusion of sewage sludge moisture was observed in both periods of speed reduction at an ultrasound power of 30 W compared to the other two high powers. In the range between ultrasound power from 0 to 30 Watts, the effect of power on the drying rate was significant, while its effect was not obvious over 30 Watts. Thus, the low ultrasound power can simply be set during the drying process. The values of the apparent activation energy in the first period of speed reduction decreased from 13.52 to 12.78 kJ mol⁻¹ and from 17.21 to 15.10 kJ mol⁻¹ in the second period of speed reduction with an increase in ultrasound power from 30 to 150 watts. The values of the apparent activation energy for two periods of speed reduction using ultrasound were less than with convective drying with hot air only. According to other studies by Salim et al. [23], sewage sludge was used by including it in baked clay bricks to obtain the properties and leaching ability of heavy metals. The use of sewage sludge in baked clay bricks can lead to the production of bricks of good quality. Thus, the recycling of waste in the production of bricks seems to be a viable solution to the problem of environmental pollution, as well as an economical option for designing green construction [24].

Latosinskaya et al. [25] proposes to convert the sludge into synthetic zeolites for the purpose of further disposal of sewage sludge ash. Zeolite P can be noted as one of the known types of zeolites. Zeolite P is synthesized from sewage sludge ash by chemical conversion. The excess sludge ash conversion process is carried out by activation

at temperatures of 60°C and 90°C, crystallization temperatures of 60°C and 90°C, a crystallization time of 72 hours and an SSA:NaOH ratio of 1:1.4. After the zeolitization process, changes in the surface of the ash particles, identification of crystallized phases, cation exchange capacity and specific surface area were monitored. The activation temperature and crystallization at a temperature of 90°C were the most optimal conditions for the synthesis of zeolite P. The described method of ash formation of sewage sludge assumes to obtain a material suitable for use. Górká et al. [26] carried out studies on anaerobic co-digestion of sludge from municipal wastewater treatment plants. During the processes of coagulation, ozonation and backwashing of fast anthracite filters, an aqueous precipitate was formed. Its characteristics and properties depend on the quality of raw water, treatment methods, as well as the types of chemicals used and their doses. According to the Polish law of December 4, 2012 (Journal of Laws 2013, point 21), water sludge is to be treated as hazardous waste. According to the results of the experiments of these authors, it was proposed to increase the production of biogas due to the joint fermentation of wastewater and aqueous sludge. The results of these studies by the authors can serve as a basis for developing a methodology for monitoring and sludge disposal.

Czechowska-Kosacka et al. [27] investigated sewage sludge and its mixtures with fly ash for use as an additive in the production of building materials. The experiment was carried out by the author using X-ray diffraction. Using a scanning electron microscope, the shape, morphology of the samples, and the chemical composition in the microarray were determined. Sewage sludge ash can be used for construction purposes. In the studied experimental data, an increased content of anhydrite and rock-forming calcite is noted in relation to the sludge. To determine the percentage of waste added in the production of building materials, additional strength tests of the resulting material are required.

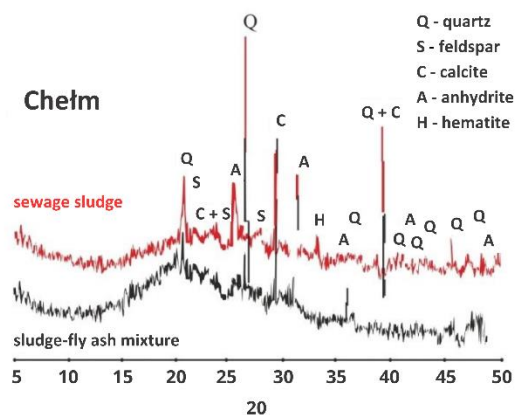

Figure 4. X-ray diffractogram of sewage sludge from the treatment facilities "Belavin" in Chelm and a mixture of sludge and fly ash. *Source: Own.*

Kovalenko et al. [28] carried out certain experiments in order to obtain a more durable and inexpensive road construction material, the basis of which is sewage sludge ash reinforced with a mineral binder. During the experiments, the characteristics of the strength of the mixture of ash with sludge and ash with cement were determined, as well as the search for optimal dosages of binders. The results of a comparative analysis of the economic efficiency of using a mixture of ash from the incineration of sewage sludge, reinforced with nepheline sludge, and traditional road construction materials turned out to have high strength and modulus of elasticity. They belong to strength classes from M20 to M100. The resulting building material (ash mixed with binders (cement, nepheline sludge)) could replace conventional building material in road construction technology. In the process of use, it would be beneficial, both in terms of physical, mechanical and economic indicators, if it is used in optimal dosages Figure 5.

The regression equations for the experimental curves are given below: The structure formation time is 14 days. $R_{compr} = -0.624x^4 + 8.4342x^3 - 37.286x^2 + 64,456x - 27,392$; $R^2 = 0,9821$. The formation time of the structure is

This study showed that triclosan is the predominant antibacterial compound in sewage sludge that affects *E. coli*, despite the simultaneous use of many other antibiotics and non-antibiotics. Chenga et al. [31] in their research studied the viability of modified bentonite as a conditioning agent for the stabilization of heavy metals (i.e., Cu, Zn, Cr, Pb and Cd) and the preservation of nutrients (i.e., total nitrogen (TN), total phosphorus (TP), available nitrogen (available N) and Olsen phosphorus (Olsen-P) in sewage sludge for agricultural use, the test results are shown in Figure 7.

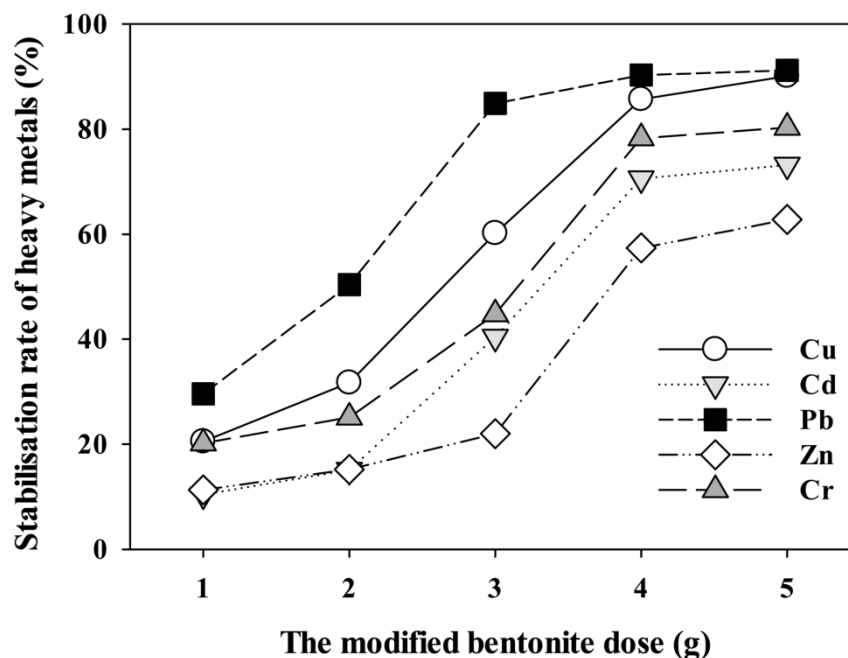

Figure 7. The degree of stabilization of the content of heavy metals in the sewage sludge (weight of each sample = 50 g) depending on the dose of modified bentonite (1-5 g). *Source: Own.*

The results of the research were as follows: modified bentonite stabilized heavy metals and preserved nutrients in the sewage sludge; an optimal ratio of a mixture of conditioned sewage sludge with soil (1:2) for agricultural use was proposed; modified bentonite allowed the use of sewage sludge as fertilizer in agriculture. Pancevska et al. [32] conducted research on the conversion of sewage sludge into activated carbon. The conversion of sewage sludge into activated carbon based on its high content of organic components not only solves the problem of disposal of sewage sludge, but also turns solid waste into a useful material in the production of adsorbent for wastewater treatment. In this study, activated carbon based on sludge was obtained using sewage sludge from the Volkovo Wastewater Treatment Plant in Skopje by chemical activation using a 25% $ZnCl_2$ solution and carbonation at a temperature of 600 °C for 50 minutes. The resulting activated carbon based on sediment was characterized using a scanning electron microscope, an X-ray diffractometer and well-known standard methods such as ash and moisture content, as well as adsorption capacity using the iodine number method. The resulting activated carbon based on sediment has a macroporous structure and interchangeable cations, which makes it suitable as an adsorbent for wastewater treatment, the test results are shown in Figure 8.

Sewage sludge generated at the Volkovo treatment facilities in Skopje, Republic of North Macedonia has been successfully converted to activated carbon based on sludge using the chemical activation method. The resulting activated carbon based on sediment was characterized using a scanning electron microscope, X-ray diffractometer, iodometric method and ash and moisture content. The results showed that activated carbon based on sediment has a macroporous structure and interchangeable cations, which makes it suitable as an adsorbent for wastewater treatment. The results also showed that activated carbon based on sediment has a higher ash content, bulk density and humidity, while the value of the iodine number is within the normal range.

The results of research by Verbovsky et al. [33] on the intensification of existing mechanical methods for treating sediments. An effective way to intensify the process of sewage sludge dehydration is electrical

dehydration, which involves the use of an electric field during mechanical sludge dehydration. The process of electrical dehydration will not only reduce the moisture content of sediments to 20...40%, but also reduce the concentration of heavy metals and pathogens in sediments. The main goal of the authors is to study the possibility of electric dehydration of activated sludge from secondary sedimentation tanks of urban sewage treatment facilities in the city of Lvov (Ukraine). Scientists used empirical research methods; the test results are shown in Figure 9.

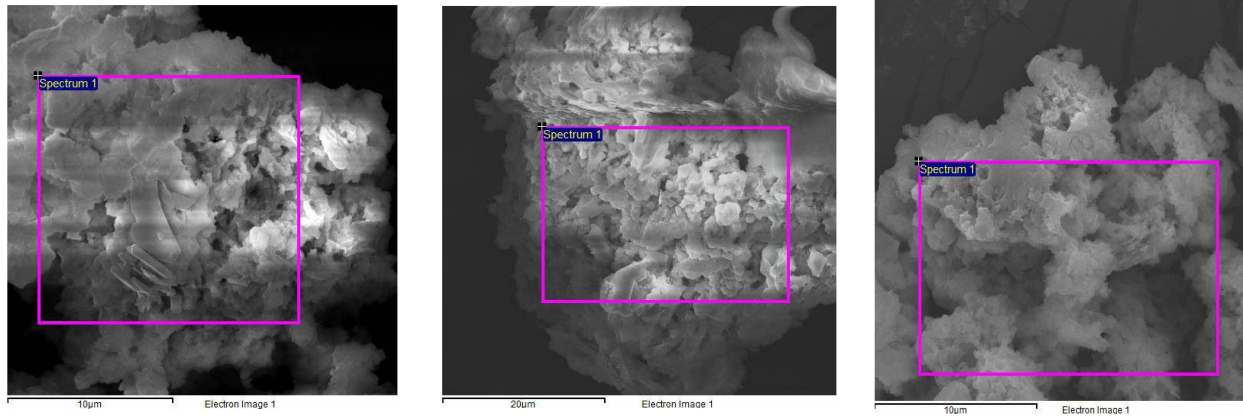

Figure 8. Micrographs of a sample for EDS analysis. *Source: Own.*

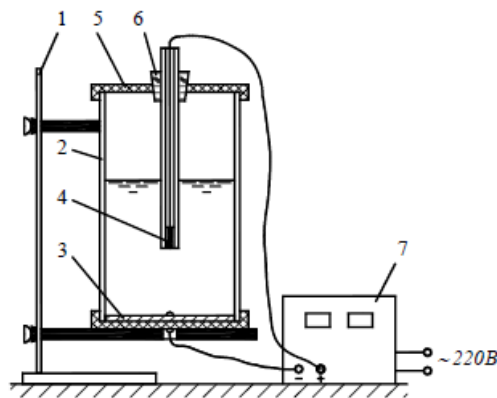

Figure 9. The laboratory-scale device for electro-dewatering of sewage sludge scheme: 1 – laboratory tri-pod; 2 – cylindrical capacity; 3 – cathode; 4 – anode; 5 – lid; 6 – sealing insert; 7 – electric-current rectifier. *Source: Own.*

A laboratory stand was designed for electro-dehydration of sewage sludge. The activated sludge with a moisture content of 98% was examined. It is shown that the effect of dehydration of activated sludge, depending on the duration of its treatment, is an S-shaped curve resembling a kinetic autocatalytic reaction with three periods: induction, basic, damping. The possibility of electro-dehydration of sewage sludge with a maximum dewatering effect of 60% is proved. Therefore, it is proposed to perform mechanical dehydration of urban wastewater sediments using an electric field. Ab Latif et al. [34] consider the use of sewage sludge ash as a replacement for cement in concrete production. Sewage sludge ash is a powdery material containing a high percentage of SiO₂, Al₂O₃, Fe₂O₃, CaO, P₂O₅ and SO₃ and is moderately reactive in terms of pozzolanicity. Many researchers have incinerated sewage sludge at temperatures ranging from 600°C to 900°C to produce sewage sludge ash. Partial replacement of cement with sewage sludge ash contributed to an increase in the compressive and bending strength of concrete. Meanwhile, replacing 5% of sewage sludge ash by weight of cement was considered to be the optimal content to obtain the best mechanical performance of concrete. In addition, concrete workability improved after 28 days with the addition of sewage sludge ash.

Impact

The accumulation of precipitation at wastewater treatment plants on the one hand complicates their production activities, causes the need to expand the network of sludge maps for the storage and disposal of sewage sludge, and on the other hand, potential sources of pollution of the biosphere, hydrosphere, lithosphere and alienation

of scarce land resources arise in the epicenter and nearby territories of cities with the accumulation of sewage sludge. Analysis of methods of neutralization and disposal of sewage sludge shows the effectiveness of their use in various fields of activity. The use of these methods leads to a reduction in waste disposal areas, minimizing their impact on the environment, reducing the volume of waste storage, and economically advantageous ways of their secondary use.

Conclusion

The problem of disposal of sewage sludge remains unresolved today. The relevance of this problem is caused on the one hand by active processes of urbanization, on the other hand by the emergence of new scientific data on the processes of interaction of precipitation components with the environment. The analysis of scientific publications indicates the need for a comprehensive approach to the disposal of excess sludge, considering specific conditions and factors. The main trends in the disposal of sewage sludge in the review of research by various scientists were: the use of sludge ash as additives in road construction; partial replacement of cement with ash from sewage sludge contributed to an increase in the compressive and bending strength of concrete; activated carbon based on sediment has a macroporous structure and interchangeable cations, which makes it suitable as an adsorbent for wastewater treatment; electro-dewatering technology allows to reduce the humidity of precipitation to 20...40%, reduce the concentration of heavy metals and pathogens in precipitation; modified bentonite stabilized heavy metals and preserved nutrients in sewage sludge; the use of ultrasound can improve the activity of excess sludge and increase the efficiency of the anaerobic digestion process and the final production of biogas. The combination of a solar drying layer and traditional solar drying technology can be noted as the most promising for the Mangystau region (Aktau city). There are about 3329.47 hours of sunlight in Aktau during the year, which is an excellent prospect for using a solar greenhouse. Also, with greater economic efficiency, it is possible to use sludge ash as additives in road construction, since in the Mangystau region there is a low cost of natural gas needed for burning sewage sludge. Also, due to the increase in urbanized territories, there is an urgent need to build motor roads to improve the quality of life of the local population.

Conflict of interest

There are no conflicts to declare.

Acknowledgments

This article is a review. The article indicates technologies for the recycling of sewage waste

Referenses

- [1] U.S. Environmental Protection Agency, (2023).
- [2] The Kazakhstan project “Caspian zhylu arnasy” of the Mangystau region, 2018-2022, (2022).
- [3] K. Jumasheva, S. Syrlybekkyzy, A. Serikbayeva, F. Nurbaeva, A. Kolesnikov, Study the composition and environmental impact of Sewage Sludge, *J. Ecol. Eng.* 24 (2023) 315–322. <https://doi.org/10.12911/22998993/158544>.
- [4] Z. Zonghe, N. Baolian, L. Haiyan, The trial of sludge dewatering and drying by solar energy, *Water and Wastewater, China.* (2003) 111–113.
- [5] Y. Jun, F. Haojie, S. Shanbin, et al., The experimental study of sewage sludge drying fundamental characteristics, *Water Wastewater Eng.* (2008) 185–188.
- [6] A. Li, Y. Qu, Z. Yang, et al., Surface configuration and moisture transference during sewage sludge drying, *J. Chem. Ind. Eng.* (2018) 1011–1015.
- [7] A. Yi, L. Jianzhong, et al., The effects of solar radiation intensity on the drying properties of sludge, *Renew. Energy.* (2019) 715–721.
- [8] L. Haiyan, L. Weiyi, Z. Zheng, Experimental study on solar sludge drying, *ActaEnergiae Solaris Sin.* (2012) 479–482.
- [9] S. Kaifeng, L. Yanfeng, W. Dengjia, E. Al., Study on the relationship between outdoor temperature and solar radiation, *Civ. Eng. Environ. Eng.* 5 (2015) 116–121.
- [10] K. Zabielska-Adamska, Sewage sludge bottom ash characteristics and potential application in road embankment, *Sustainability.* 12 (2019) 39. <https://doi.org/10.3390/su12010039>.
- [11] P.I. Pogozhev, Geotube and installation for separation of suspensions by filtration using a geotube, Patent №0002712603-29.01.2020., 2020.
- [12] NPC Geotube, <http://geotub.ru/manufacture>.
- [13] T.F. Sampaio, I.A. Guerrini, X.L. Otero, F.M. Vazquez, J.C. Bogiani, F.C. Oliveira, J.L. Gava, M.A. Ciol, K.M.

- Littke, R.B. Harrison, The impact of biosolid application on soil and native plants in a degraded Brazilian atlantic rainforest soil, *Water, Air, Soil Pollut.* 227 (2016) 1. <https://doi.org/10.1007/s11270-015-2689-7>.
- [14] T. Hernández, C. Chocano, J.L. Moreno, C. García, Use of compost as an alternative to conventional inorganic fertilizers in intensive lettuce (*Lactuca sativa* L.) crops—Effects on soil and plant, *Soil Tillage Res.* 160 (2016) 14–22. <https://doi.org/10.1016/j.still.2016.02.005>.
- [15] M. Jakubus, E. Bakinowska, Visualization of long-term quantitative changes of microelements in soils amended with sewage sludge compost evaluated with two extraction solutions, *Commun. Soil Sci. Plant Anal.* 49 (2018) 1355–1369. <https://doi.org/10.1080/00103624.2018.1464177>.
- [16] A.L. Florentino, A. d. V. Ferraz, J.L. de M. Gonçalves, V. Asensio, T. Muraoka, et.al., Long-term effects of residual sewage sludge application in tropical soils under Eucalyptus plantations, *J. Clean. Prod.* 220 (2019) 177–187. <https://doi.org/10.1016/j.jclepro.2019.02.065>.
- [17] L. Meng, W. Li, S. Zhang, X. Zhang, Y. Zhao, L. Chen, Improving sewage sludge compost process and quality by carbon sources addition, *Sci. Rep.* 11 (2021) 1319. <https://doi.org/10.1038/s41598-020-79443-3>.
- [18] P. e A. de D.A. Ministério da Agricultura, The Brazilian Government recently adopted Resolution No. 498/2020, (2020).
- [19] P. e A. de D.A. Ministério da Agricultura, Resolução nº 498, de 19 de Agosto de 2020. <https://www.scribd.com/document/585203764/RESOLUCAO-Nº-498-DE-19-DE-AGOSTO-DE-2020>.
- [20] P. e A. Ministério da Agricultura, Instrução Normativa no 61, de 08 de Julho de 2020. <http://www.in.gov.br/web/dou/-/instrucao-normativa-n-61-de-8-de-julho-de-2020-266802148>.
- [21] X. Xu, D. Cao, Z. Wang, J. Liu, J. Gao, M. Sanchuan, Z. Wang, Study on ultrasonic treatment for municipal sludge, *Ultrason. Sonochem.* 57 (2019) 29–37. <https://doi.org/10.1016/j.ultsonch.2019.05.008>.
- [22] M.K. Sun, C.Y.V. Huang, Evaluation of the characteristics of thin-layer drying of urban sewage sludge using air-ultrasonic convection with hot air, *Ultrasound Sonochemistry.* 34 (2017) 588–599.
- [23] N.S. Abdul Salim, A. Abdul Kadir, M.A. Kamarudin, M.H. Fadzli Zaidi, M.M.A.. B. Abdullah, Investigation on properties and leachability of sewage sludge from wastewater treatment plant incorporated in fired Clay Brick, *IOP Conf. Ser. Mater. Sci. Eng.* 374 (2018) 012096. <https://doi.org/10.1088/1757-899X/374/1/012096>.
- [24] A treatment plant built into a baked clay brick. *Environment IR 2018, IOP Conf. Ser. Mater. Sci. Eng.* 374. (2018) 1–9.
- [25] J. Latosińska, Synthesis of zeolite P from sewage sludge ash, *E3S Web Conf.* 108 (2019) 02008. <https://doi.org/10.1051/e3sconf/201910802008>.
- [26] J. Górka, M. Cimochoicz-Rybicka, Possible co-fermentation of water and sewage sludge, *E3S Web Conf.* 17 (2017) 00025. <https://doi.org/10.1051/e3sconf/20171700025>.
- [27] A. Czechowska-Kosacka, Application of sewage sludge for the production of construction, *MATEC Web Conf.* 252 (2019) 05025. <https://doi.org/10.1051/matecconf/201925205025>.
- [28] O. Zubova, V. Siletskiy, D. Kulik, T. Kovalenko, M. Naskovets, Research in the field of using of ash from the incineration of sewage sludge, treated with mineral binders, for forest road construction, *E3S Web Conf.* 222 (2020) 01007. <https://doi.org/10.1051/e3sconf/202022201007>.
- [29] Z. Gu, J. Yang, J. Liu, L. Tao, Y. Zhang, L. Huang, Study on sewage sludge drying system with built-in solar drying bed, *E3S Web Conf.* 237 (2021) 01041. <https://doi.org/10.1051/e3sconf/202123701041>.
- [30] H. Barrett, J. Sun, Y. Gong, P. Yang, C. Hao, J. Verreault, Y. Zhang, H. Peng, Triclosan is the predominant antibacterial compound in Ontario sewage sludge, *Environ. Sci. Technol.* 56 (2022) 14923–14936. <https://doi.org/10.1021/acs.est.2c00406>.
- [31] Y. Cheng, K. Chon, X. Ren, M. Li, Y. Kou, M. Hwang, K. Chae, Modified bentonite as a conditioning agent for stabilising heavy metals and retaining nutrients in sewage sludge for agricultural uses, *Water Sci. Technol.* 84 (2021) 2252–2264. <https://doi.org/10.2166/wst.2021.450>.
- [32] V. Pancevska, A. Zendelska, Preparation and characterization of sludge-based activated carbon, *Resour. Technol.* 16 (2022) 61–67. <https://doi.org/10.46763/NRT22161061p>.
- [33] O. Verbovskiy, V. Orel, O. Matsiyevska, D. Derkach, Sewage sludge dewatering by electric field, *Probl. Water Supply, Sewerage Hydraul.* (2022) 16–25. <https://doi.org/10.32347/2524-0021.2022.40.16-25>.
- [34] A. Ab Latif, A. Nazarudin, M. Noor Safwan, Use of sewage sludge ash as a cement replacement in concrete: A review, *Gading J. Sci. Technol.* 3 (2020) 59–65.