



Article citation info:

Kluz R, Habrat W, Bucior M, Krupa, Sęp J. Multi-criteria optimization of the turning parameters of Ti-6Al-4V titanium alloy using the Response Surface Methodology. *Eksploracja i Niezawodność – Maintenance and Reliability* 2022; 24 (4): 668–676, <http://doi.org/10.17531/ein.2022.4.7>

Multi-criteria optimization of the turning parameters of Ti-6Al-4V titanium alloy using the Response Surface Methodology

Indexed by:



Rafał Kluz^{a,*}, Witold Habrat^b, Magdalena Bucior^a, Krzysztof Krupa^c, Jarosław Sęp^a

^aRzeszów University of Technology, Department of Manufacturing and Production Engineering, Faculty of Mechanical Engineering and Aeronautics, al. Powst. Warszawy 8, 35-959 Rzeszów, Poland

^bRzeszów University of Technology, Department of Manufacturing Techniques and Automation, Faculty of Mechanical Engineering and Aeronautics, al. Powst. Warszawy 8, 35-959 Rzeszów, Poland

^cRzeszów University of Technology, Department of Materials Science, Faculty of Mechanical Engineering and Aeronautics, al. Powst. Warszawy 12, 35-959 Rzeszów, Poland

Highlights

- The RSM method is an effective tool for modeling the turning process of the Ti6Al4V titanium alloy.
- The use of a polycrystalline diamond cutting insert for dry turning enables environmentally friendly machining.
- Too high temperature during the cutting process leads to the release of chemical compounds.
- Multi-criteria optimization of the turning process enables to obtain cutting parameters that meet the quality requirements.

Abstract

The paper depicts an application of Response Surface Methodology (RSM) for predicting selected parameters in turning of Ti-6Al-4V titanium alloy using polycrystalline diamond tool. Response surface plots that are generated by the model helps in determining the optimum combination of input factors (cutting speed v_c and feed rate f) for best possible surface roughness (S_a), cutting force (F_c) and temperature (T) for dry and cooling turning. The methodology of multi-criteria optimization was used to establish the interaction between input parameters and given responses.

Keywords

Response Surface Methodology, titanium alloy, multi-criteria optimization, turning process.

This is an open access article under the CC BY license (<https://creativecommons.org/licenses/by/4.0/>)



1. Introduction

Titanium alloys have a wide range of applications [28]. This is due to properties such as high specific strength (ultimate strength to density ratio), resistance on high temperature and corrosive environment. This kind of material is used to manufacture elements of airplanes, helicopters such as the construction of blades in engines, window frames in the cockpit [28] or for landing gear [1]. Plate and frame heat exchangers made with titanium alloy are used in power plants, refineries, air conditioning systems, chemical plants, offshore platforms, surface ships and submarines [28]. Knee prostheses, trauma fixation devices (nails, plates, screws), surgical devices, pacemakers or implants [16] made with this alloys are also used in medicine. Objects produced from titanium alloys are generally characterized by high requirements for accuracy and surface roughness, and therefore they are shaped by machining processes. The processes for titanium alloys are difficult due to the properties, which is hard-to-machine materials [6]. This leads to occurrence of high value of temperature and the rapid wear of the cutting tools. The available studies in this scientific field [3, 11, 18] indicate the main causes of these difficulties, including: low thermal conductivity, high chemical reactivity with most tool materi-

als, thermoplastic instability during machining, tendency for chips to stick to tool, or finally the tendency to build up edge, which promotes chipping of the cutting edge [27].

Due to the low value of the thermal conductivity of titanium, the heat generated in the cutting zone is not dissipated, but this is concentrated on the edges and tips of the cutting blade. High temperature (in the treatment zone exceeding even 1100° C) leads to intensive wear of the blade and its plastic deformation. With respect to the high temperature in the machining zone, the phenomenon of softening takes place and the cutting resistance increases. The strong chemical affinity of titanium to tool materials promotes adhesion and the formation of built-up edges on the tips of cutting tools, and, consequently, their rapid blunting and chipping. In turn, the high elasticity of titanium causes the formation of elastic deformations and vibrations during machining, which affects the changes in the instantaneous values of the depth of cut. At small depths, there is no longer cutting with a blade, but only plastic deformation, which also strengthens the processed material and increases its ultimate strength and hardness [14, 30].

Improvement in the machinability of titanium alloys can be obtained by lowering temperature value of the process. The recommendations

(*) Corresponding author.

E-mail addresses: R. Kluz (ORCID: 0000-0001-6745-294X): rkkmtiop@prz.edu.pl, W. Habrat (ORCID: 0000-0002-9010-8175): witekhab@prz.edu.pl, M. Bucior (ORCID: 0000-0002-1081-5065): magdabucior@prz.edu.pl, K. Krupa (ORCID: 0000-0003-1822-7230): krupa@prz.edu.pl, J. Sęp (ORCID: 0000-0003-2544-2211): jsztmiop@prz.edu.pl

for machining titanium alloys [22] indicate on the following features: low cutting speed, high feed and depth of cut (compared to steel machining), with the use of very sharp tools reducing value of loading and the phenomena of workpiece crushing. Taking into account the possibilities for optimization of production costs, research are currently directed towards the processes of shaping titanium parts with methods ensuring maximum efficiency, while maintaining the desired surface geometric structure and the required tool life [3, 5, 13, 24].

In articles and studies on the quality of surface obtained as a result of machining, a lot of attention is paid to design of experiments (DOE) techniques [17]. Experimental procedures are mainly used in the early stages of developing technological processes. In practice, there are many factors that influence the key properties of a part. The technologist's task is to determine factors significant and insignificant in further stages of technological process. On the other hand, without prior knowledge, it is difficult to determine the significance of individual factors. In such circumstances experimental techniques are often used. Despite the determination of an appropriate set of examined factors under study, it is usually difficult to find the optimal conditions in which the technological process is to be carried out. In such a case, one of the experimental techniques should be used to determine such process conditions for which the surface quality is considered satisfactory. One of them are experimental techniques grouped under the common name of the Response Surface Method (RSM). The RSM method is a combination of mathematical and statistical methods especially useful when the process under study is influenced by several factors [4, 10, 29]. To build an empirical model, this method uses the quantitative data available from experiments to solve multivariate equations. The solution of these equations is taken as the optimum combination of input parameters. In RSM the equations are represented graphically which are indicative of relation between the input and output factors [19, 23, 26].

The selection of optimal turning parameters is crucial to enhance the quality of the industry's product and economy. There have been few attempts to optimize process parameters in turning Ti-6Al-4V alloy with various process parameters. Artificial neural networks (ANN) [7], Analysis of variance (ANOVA) [12], Fuzzy rule [12, 20] and Taguchi method [9] are among various optimization techniques applied to find the optimal turning process parameters for better results. A brief review of the literature on the optimization of input factors for the turning process of titanium alloys is presented here.

The authors of the articles [21, 22] conducted studies on the effect of changing cutting parameters on the components of the cutting force and surface roughness of Ti-6Al-4V ELI titanium alloy parts with the use of a roughing cutting insert. The research were carried out in the range of cutting speed $25 \div 40$ m/min and feed $0.1 \div 0.35$ mm/rev. During the tests, the lowest roughness equal to $Ra = 0.32 \mu\text{m}$ was ob-

tained for the feed rate of 0.1 mm/rev and the cutting speed of 25 m/min. In turn, in [22] it was shown that an increase in the cutting depth from 0.5 mm to 2 mm, at a cutting speed of 35 m/min and a feed rate of 0.25 mm/rev, increases the surface roughness Ra from $0.3 \mu\text{m}$ to $2 \mu\text{m}$. In the articles [25, 15], the Response Surface Methodology was used to optimize the turning process of the Ti-6Al-4V titanium alloy. The author of the work [25] optimized the turning process using a tool made of a TiAlN coated carbide. He conducted the tests by changing the cutting speed in the range of $30 \div 113$ m/min, the feed rate of $0.2 \div 0.4$ mm/rev and the depth of cut in the range of $0.5 \div 1$ mm. The analysis showed that the lowest surface roughness can be obtained at a cutting speed of 72 m/min and a feed rate of 0.2 mm/rev. Mia et al. [15] used RSM to study surface roughness and cutting forces in cryogenic turning of a titanium alloy with a WC coated tool. The following parameters were adopted for the tests: cutting speed in the range $78 \div 156$ m/min and feed in the range $0.12 \div 0.16$ mm/rev. As a result of the analysis, it was shown that the most favorable cutting parameters, allowing to obtain a roughness of $Ra = 1.05 \mu\text{m}$, is the cutting speed of 78 m/min at a feed rate of 0.16 mm/rev, a cutting depth of 1.0 mm and a feed force $f = 208$ N.

The present study is an investigation the influence of different cutting parameters of the Ti-6Al-4V titanium alloy at different the conditions of dry and cooling turning with a polycrystalline diamond tool. The statistical manner for determining the Response Surface Method was used to model the relationship between the parameters of the cutting process and the components of the cutting forces as well as the parameters of the surface topography. Such a multi criteria optimization technique can offer a reliable solution and a balance among all included outputs. It also helps to provide different solutions that can be very useful to select the most appropriate cutting conditions based on the desired objectives. Properly selected processing parameters are important for ensuring the required reliability in the future exploitation of the shaped products. They ensure shaping of the cutting forces in the range that prevents their excessive growth, which causes deformation of the surface layer material and its strengthening. In addition, reducing the temperature value of the cutting process and the morphology of the phase components of the workpiece surface can prevent surface damage and fatigue fracturing.

2. Devices, material and process parameters

The cutting process was examined on a test stand at the Research and Development Laboratory for Aerospace Materials (Rzeszow, Poland) on a CNC lathe Gildemeister NEF 600. The measuring system consists of a Kistler 9257B piezoelectric dynamometer - attached to the turret with a VDI holder, it enables the measurement of the cutting force components: cutting force (F_c), feed force (F_f) and passive force (F_p) (Fig. 1). The signal from the dynamometer is amplified by

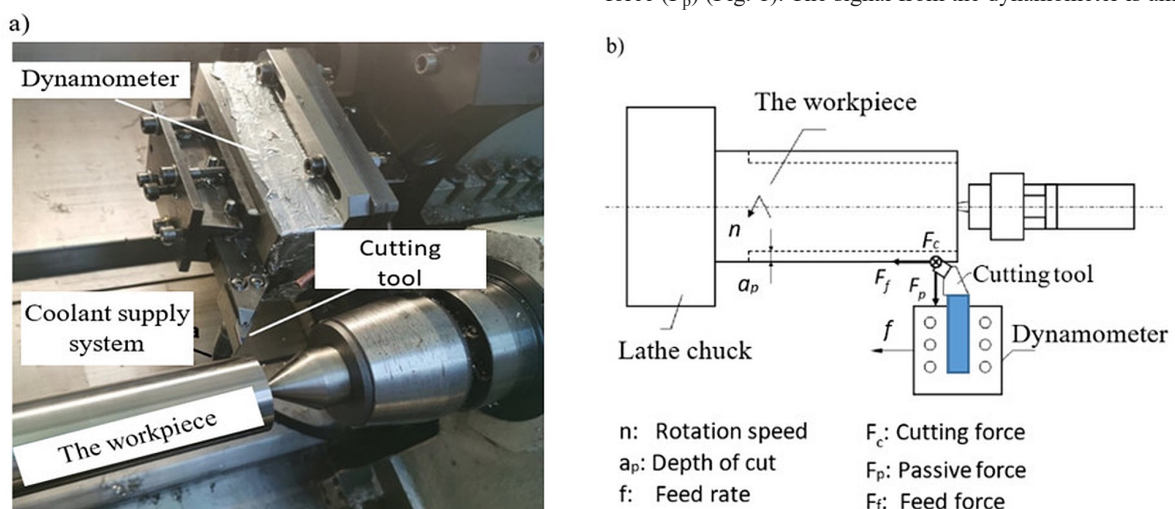

Fig. 1. View of the working space of the NEF600 lathe: a) fixing the cutting tool in the dynamometer; b) kinematic diagram of the stand

a 5070 type charge amplifier and then transmitted to a computer via USB using the National Instruments 16-bit NI 9215 analog-to-digital converter. Visualization, processing and saving of the signal is carried out using a program developed in the LabVIEW environment. The sampling frequency of the signal was set at 1 kHz (Fig. 2).

The X6540sc thermal imaging camera by FLIR (Fig. 2) with a resolution of 640 × 512 pixels and a recording speed of 126Hz: 640×512 to 4011Hz: 64×8 was used to measure values of temperature during the turning process.

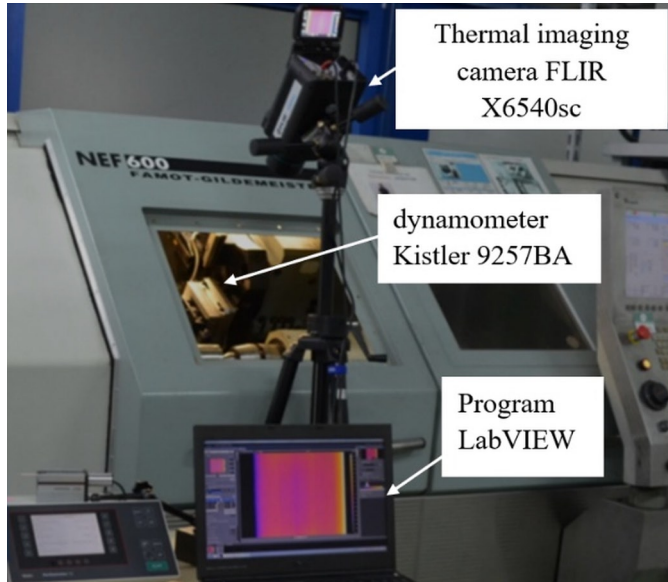

Fig. 2. Configuration of the stand with thermovision measurement during turning process

Table 1. Chemical composition of the Ti-6Al-4V alloy (wt. %) [2]

| Ti | C max | Fe max | N max | Al | O max | V | H max | Y max | Rest |
|----------|-------|--------|-------|-----------|-------|---------|-------|-------|------|
| Variable | 0.08 | 0.03 | 0.05 | 5.50-6.75 | 0.20 | 3.5-4.5 | 0.015 | 0.005 | 0.40 |

The 3D topography measurements of the treated surface were made using the optical method Alicona Infinite Focus focal differentiation microscope. The measurement included 3D topography on an area of 1.6 × 1.6 mm. This method included noise removal, shape profile filtering, topography imaging with 3D maps, determination of selected surface topography parameters and their statistical evaluation. The parameters of the surface topography were determined in accordance with ISO 25178-2 [8].

The surface observation was conducted using a HITACHI S-3400N Scanning Electron Microscope (SEM) equipped with Energy Dispersive X-ray Spectrometer (EDS) and Wavelength Dispersive X-ray Spectrometer (WDS) systems for the analysis of chemical composition and an Electron Backscattered Diffraction (EBSD) system enabling the determination of the texture of materials and the identification of phase components and morphology of their microstructure. Microstructural examination of the dry turning surface was carried out with using Nikon Epiphot 300 light microscope with NIS-Elements V2.3 software.

The material used in this study was Ti-6Al-4V titanium alloy. Due to its good properties at elevated temperatures, it is one of the species commonly used in the aviation and electrical industries. The chemical composition is provided in Table 1.

A folding tool with a polycrystalline diamond insert was used for the tests. The configuration of the toolkit included:

- lampholder: SVJBL2525M16 JET (Sandvik, Sweden)
- the cutting insert: VCGT 160404 ID5 (Iscar, Israel) (Fig. 3).

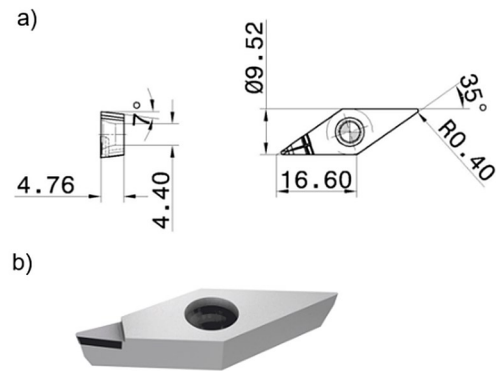

Fig. 3. Cutting insert VCGT 160404: a) dimensions, b) photo

The statistical method of determining the Response Surface Method was used to model the relationship between the parameters of the cutting process and the components of the cutting force as well as the parameters of the surface topography. Design-Expert 12 software by Stat-Ease (Minneapolis, Minnesota) was used for modeling.

A central, wall-centered composition plan was adopted during the research. The order of runs were generated by the program Design-Expert 12 (Table 2). The range of variability of the input quantities included:

- cutting speed v_c in the range of 120 ÷ 240 m/min
- feed rate f in the range of 0.1 ÷ 0.3 mm/rev,
- constant depth of cut $a_p = 0.25$ mm

To determine the optimal cutting parameters, the weighted sum method was used, because this is one of the best-known methods of multi-criteria optimization. Due to the fact that the objective func-

Table 2. Cutting parameters for Ti-6Al-4V titanium alloy, selected by mean of the RSM method

| No. | Run | Cutting speed v_c , m/min | Feed rate f , mm/rev |
|-----|-----|-----------------------------|------------------------|
| 1 | 8 | 120 | 0.1 |
| 2 | 7 | 240 | 0.1 |
| 3 | 5 | 120 | 0.3 |
| 4 | 9 | 240 | 0.3 |
| 5 | 6 | 120 | 0.2 |
| 6 | 4 | 240 | 0.2 |
| 7 | 3 | 180 | 0.1 |
| 8 | 1 | 180 | 0.3 |
| 9 | 10 | 180 | 0.2 |
| 10 | 2 | 180 | 0.2 |

tions are expressed on various scales of values, their transformation was performed to a dimensionless form assuming values in the range [0, 1].

Taking into account the features of turning, surface roughness was a critical parameter ensuring the correct course of the process. Additionally, in the case of turning with cooling, the passive force responsible for shape errors was measured. In the case of dry turning, the

temperature values were measured. The values should be the range that does not cause the release of chemical compounds adhesively adhering to the surface of the part and the phenomena of graphitization.

3. Results and discussion

3.1. Turning with tool cooling

During the precision turning of the Ti-6Al-4V titanium alloy, the courses of the F_c (cutting force), F_f (feed force), F_p (passive force) components of the cutting force were collected using the measurement path presented in Fig. 1b. Cooling and lubricating fluid Ecocool Global 10 was used for cooling. In the conducted research, an aqueous concentrate solution with a concentration of 8% was used. The liquid was fed using a special nozzle that was an integral part of the HPC system holder. The liquid pressure was 8MPa. The analysis of forces in the finishing turning process provides information on the mechanics of the cutting process, taking into account the properties of the workpiece material and tool geometry. Table 3 presents the results of measurements of the cutting force components during turning with cooling through the tool, for the adopted research range.

Table 3. Cutting force components according to the RSM methodology

| No. | Cuttingspeed, m/min | Feedrate, mm/rev | F_c , N | F_p , N | F_f , N |
|-----|---------------------|------------------|-----------|-----------|-----------|
| 1 | 120 | 0.1 | 65.92 | 24.10 | 20.56 |
| 2 | 240 | 0.1 | 63.32 | 22.91 | 19.28 |
| 3 | 120 | 0.3 | 151.11 | 41.74 | 23.67 |
| 4 | 240 | 0.3 | 144.92 | 39.75 | 22.08 |
| 5 | 120 | 0.2 | 111.16 | 32.96 | 23.18 |
| 6 | 240 | 0.2 | 105.27 | 28.18 | 19.90 |
| 7 | 180 | 0.1 | 64.28 | 22.63 | 18.72 |
| 8 | 180 | 0.3 | 146.47 | 42.56 | 22.78 |
| 9 | 180 | 0.2 | 107.35 | 30.25 | 21.68 |
| 10 | 180 | 0.2 | 106.26 | 27.82 | 21.62 |

Based on the ANOVA analysis of variance, appropriate models were selected and adequate regression equations were obtained for the values of the F_c , F_f , F_p force components (1-3).

$$F_c = 25.82 - 0.0407v_c + 475.303f - 150.805f^2 \quad (1)$$

$$F_p = 17.14 - 0.022v_c + 90.66f \quad (2)$$

$$F_f = 21.10 - 0.017v_c + 16.60f \quad (3)$$

Figure 4 shows the graphs of the components of the cutting forces as a function of the cutting speed and feed rate. The analysis of Fig. 4 shows that the cutting forces components have a very similar course. Both the main cutting force F_c and the passive force F_p practically do not change with increasing cutting speed. Their increase occurs with the increase in feed rate. Increasing the feed rate from $f = 0.1$ mm/rev to $f = 0.2$ mm/rev increases the cutting force F_c by 69.23%. Increasing the feed rate to $f = 0.3$ mm/rev results in a further increase in cutting force by 36.03%. It should be noted that the cutting force F_c and the passive force F_p are strongly correlated with each other. This is evidenced by the value of the Pearson correlation coefficient, $r = 0.98$. The feed force F_f is correlated to a lesser degree with the cutting force F_c ($r = 0.84$). Its value decreases slightly with the increase of the cutting speed, while, similarly to the other components, it increases with the increase of the feed rate.

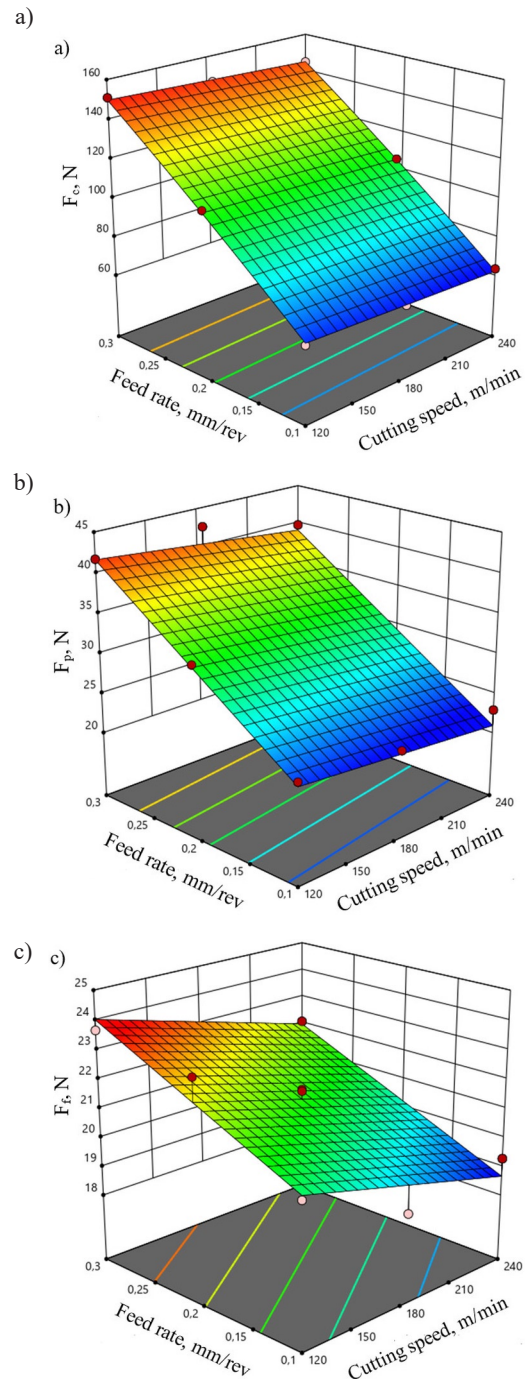

Fig. 4. Graph of the components of cutting forces: a) F_c , b) F_p , c) F_f

On the basis of the final turning tests of the Ti-6Al-4V alloy with the use of a polycrystalline diamond cutting insert, the influence of the cutting parameters on the selected parameters of the surface topography was determined. Table 4 presents the results of measurements of the surface topography parameters after turning with the tool cooling.

The analysis of the measurement results showed that the Sa (arithmetical mean of the height deviations of the surface) parameter is strongly correlated with the Sz parameter (the maximum height of surface). Pearson's correlation coefficient is $r = 0.99$ (Fig. 5). Therefore, the further part of the analysis focuses on one of these parameters (Sa) most often used in industrial practice.

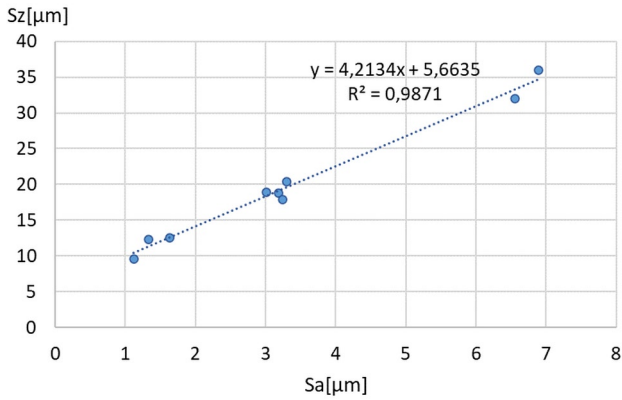

Fig. 5. Graph of the correlation of the Sa and Sz parameters

Regardless of the adopted cutting speed, it can be noticed that the roughness Sa increases with the increase of the feed rate value. In the case of a feed of $f = 0.3$ mm/rev, an increase in the cutting speed from $v_c = 120$ m/min to $v_c = 180$ m/min causes an increase in roughness by 5.03% to a value of $Sa = 6.59$ μm . In this case, a further increase in the cutting speed does not significantly affect the surface roughness. For a feed rate of $f = 0.1$ mm/rev, an increase in the cutting speed from $v_c = 120$ m/min to $v_c = 180$ m/min results in a slight increase in surface roughness from $Sa = 1.33$ μm to $Sa = 1.63$ μm , and then causes it to decrease by 31.28% at a cutting speed of $v_c = 240$ m/min (Fig. 6a).

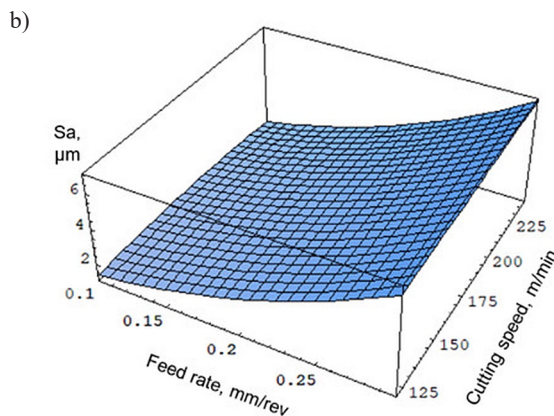
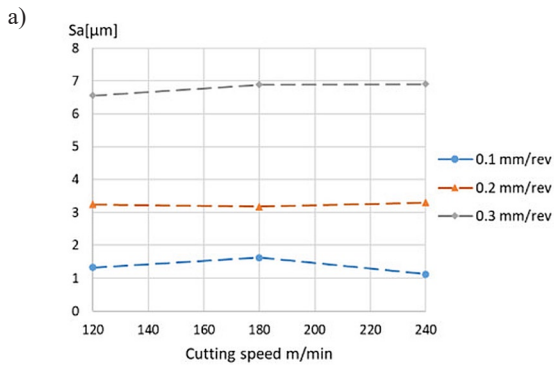

Fig. 6. Dependence of the Sa parameter on the cutting speed a) test results, b) plot of the regression function

Based on the ANOVA analysis of variance, an adequate regression model of the Sa parameter was developed (Fig. 6b), (4):

$$S_a = -0.65226 + 9.02652f + 35.9614f^2 + 76.4532f^3 + 0.01230v_c - 0.105fv_c + 0.00833f^2v_c + 0.000028v_c^2 + 0.0003472fv_c^2 - 2.62091 \cdot 10^{-7}v_c^3 \quad (4)$$

3.2. Dry turning process

The temperature tests in the cutting zone were to verify whether the increase in cutting speed and feed rate resulted in higher temperatures in the chip forming zone. Too high temperature may lead to unfavorable phenomena in the structure of the surface layer and limit the use of a polycrystalline diamond tool due to the possibility of graphitization. Fig. 7 shows the results of the temperature measurement and the plot of the regression function.

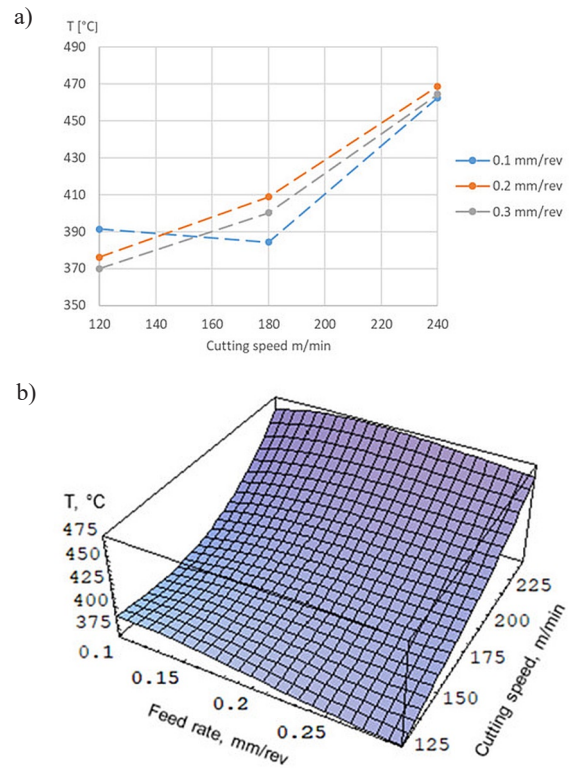

Fig. 7. The influence of cutting parameters on the temperature value; a) test results, b) plot of the regression function

The adequate equation of the regression function, statistically verified at the significance level of $\alpha = 0.05$, describing the influence of the cutting process parameters on the temperature value, takes the form (5):

$$T = 540.887 - 873.187f - 3056.4f^2 + 6563.45f^3 - 1.37693v_c + 16.95fv_c \quad (5)$$

At a feed rate of $f = 0.1$ mm/rev, an increase in the cutting speed from $v_c = 120$ m/min to $v_c = 180$ m/min causes a slight decrease in temperature by 1.79%. The temperature in the considered range of cutting speed changes seems to be stabilized much below the value at which the graphitization phenomenon occurs. A further increase in cutting speed causes the temperature to rise sharply by 20.39% to 462°C. During the machining of the shaft with both the feed rate $f = 0.2$ mm/rev and $f = 0.3$ mm/rev, a similar trend of temperature increase was observed with the increase of the cutting speed.

On the basis of the final turning tests of the Ti-6Al-4V alloy with the use of a polycrystalline diamond cutting insert, the influence of the cutting parameters on the selected parameters of the surface topography was also determined. As in the case of turning with tool cooling, the Sa parameter is also strongly correlated with the Sz parameter. Pearson's correlation coefficient is $r = 0.999$. Therefore, in the further part of the analysis, the regression equation was estimated also only for the Sa parameter.

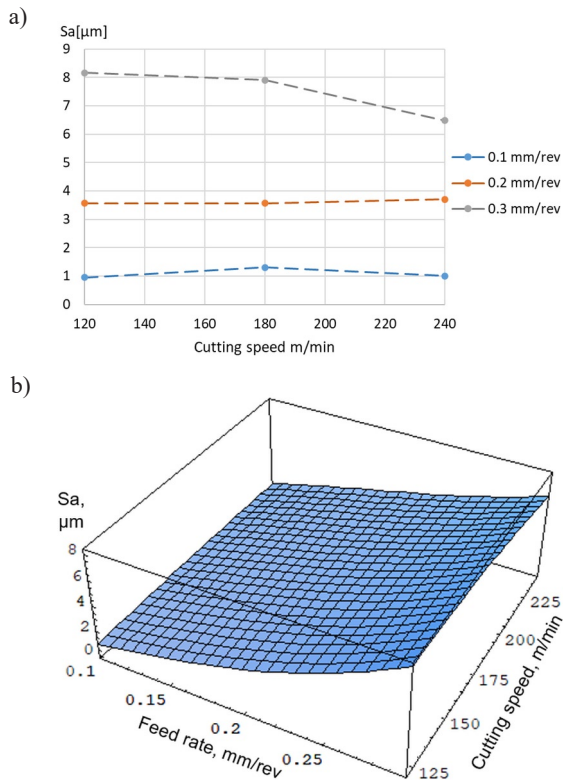

Fig. 8. Dependence of the Sa parameter on the cutting speed and feed rate a) test results, b) plot of the regression function

Table 4. Surface topography parameters in accordance with the methodology of the RSM

| Lp. | Cutting speed, m/min | Feed rate, mm/rev | Sa, μm | Sz, μm |
|-----|----------------------|-------------------|--------|--------|
| 1 | 120 | 0.1 | 1.33 | 12.37 |
| 2 | 240 | 0.1 | 1.12 | 9.59 |
| 3 | 120 | 0.3 | 6.56 | 32.04 |
| 4 | 240 | 0.3 | 6.91 | 31.18 |
| 5 | 120 | 0.2 | 3.24 | 17.89 |
| 6 | 240 | 0.2 | 3.3 | 20.35 |
| 7 | 180 | 0.1 | 1.63 | 12.56 |
| 8 | 180 | 0.3 | 6.89 | 35.99 |
| 9 | 180 | 0.2 | 3.18 | 18.78 |
| 10 | 180 | 0.2 | 3.01 | 18.90 |

The adequate equation of the regression function, statistically verified at the significance level of $\alpha = 0.05$, describing the influence of the cutting process parameters on the temperature value, takes the form (6):

$$S_a = 0.44594 - 13.4516f + 9.33451f^2 + 340.137f^3 - 0.009491v_c + 0.37375fv_c - 0.795833f^2v_c - 0.000035v_c^2 - 0.000354v_c^2 + 5.79579 \cdot 10^{-8}v_c^3 \quad (6)$$

When analyzing the results of roughness measurements during dry turning and with cooling through the tool, similar trends in the roughness change depending on the cutting parameters can be noticed (Fig. 8a). In both the first and the second case, when turning with a feed rate of $f = 0.1$ mm/rev, an initial increase in the value of the Sa parameter can be observed, which decreases after exceeding the cutting speed of $v_c = 180$ m/min. In the case of turning with a feed rate

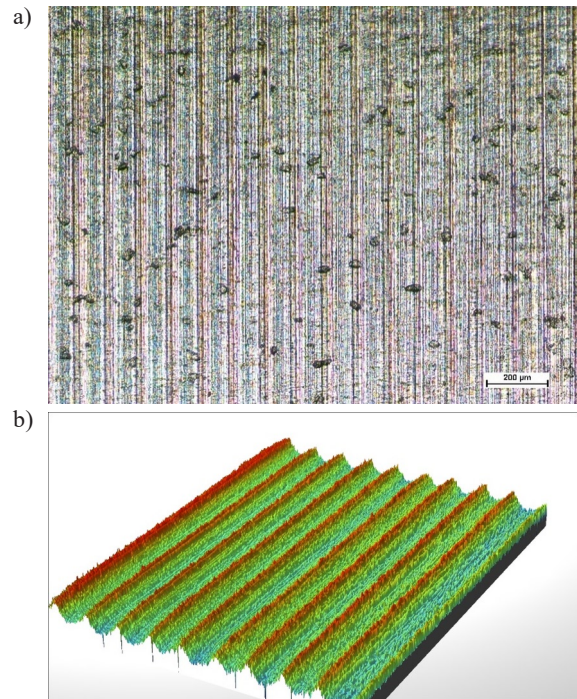

Fig. 9. Surface obtained after dry turning at the cutting speed $v_c = 120$ m/min and feed rate $f = 0.3$ mm/rev; a) view of surface, b) three-dimensional surface topography

of $f = 0.3$ mm/rev, the value of the Sa parameter remains at a similar level in the cutting speed range of $v_c = 120 \div 180$ m/min, and then it rapidly decreases. It should also be noted that the increase in feed rate and the associated temperature rise leads to the appearance of a chemical reaction causing the release of a compound that adhesively adheres to the surface. On an optical microscope image, it takes the form of small spots, $25 \div 40$ μm wide (Fig. 9a). The thickness of the layers of the adhering compound are so small that it is difficult to observe them on the three-dimensional surface topography (Fig. 9b). When measuring surface topography, they can be considered noise and filtered out. Their removal is extremely difficult and requires time-consuming and costly technological operations. Inaccurate cleaning of the treated surface causes a change in the properties of the top layer and deterioration of the tribological properties of the parts.

Figure 10 shows a photo of the surface of the part made with the use of a scanning electron microscope for feed rate $f = 0.3$ mm/rev and $v_c = 120$ m/min. Figure 11 shows the chemical composition of the Ti6Al4V titanium alloy (11a) and the compound adhesively adhering to the surface (11b). Analysis of the chemical composition shows that the adhesive compound is formed as a result of a thermal chemical re-

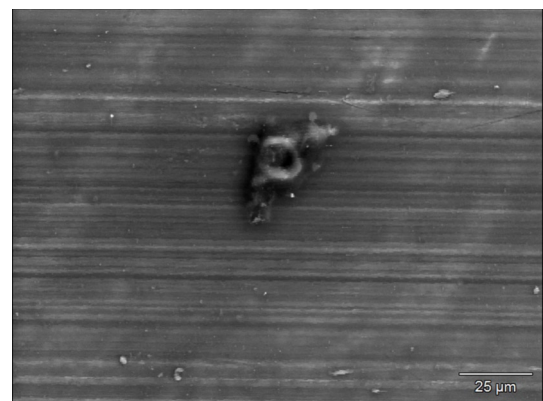

Fig. 10. Scanning electron microscope photo of the surface after dry turning for feed rate $f = 0.3$ mm/rev and $v_c = 120$ m/min

action of the residual cooling lubricant used during roughing. The use of a liquid at this stage of treatment is necessary due to the tendency of the Ti6Al4V titanium alloy to harden the surface layer. Removal of the remaining cooling lubricant is very difficult and expensive, and the process itself does not guarantee the possibility of cleaning the surface of the remaining chemicals. It should be noted here that the chemical reaction only takes place at increased feed rate and at elevated temperatures. In the case of turning with a low feed rate value, no precipitated chemical compounds were observed on the surface of the part. This opens the possibility of machining without the use of a cooling lubricant, in an ecological manner, while ensuring a surface roughness similar to that in the case of using a coolant, and with the appropriate selection of cutting parameters, even smaller.

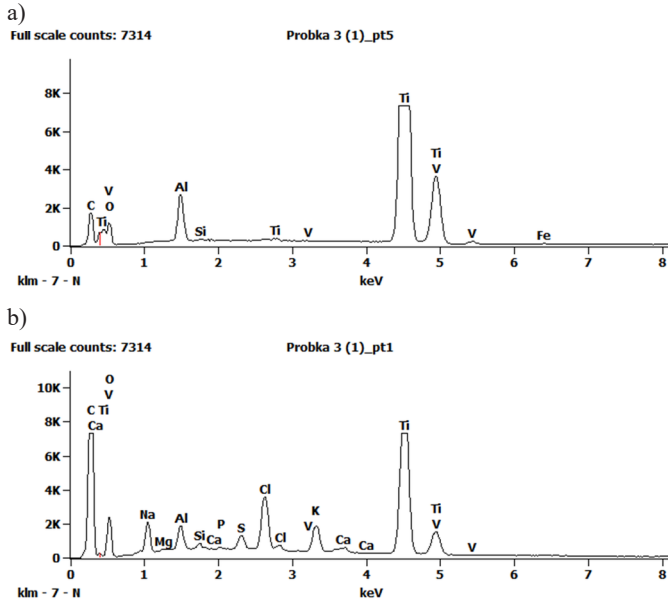

Fig. 11. Chemical composition of a) titanium alloy Ti6Al4V, b) compound adhesively adhering to the surface

4. Multi-criteria optimization

Due to the physical properties of the Ti6Al4V titanium alloy, the hardening of the surface layer as a result of permanent deformation and low thermal conductivity, finishing turning of the Ti-6Al-4V alloy with the use of a polycrystalline diamond cutting insert requires the selection of optimal process parameters. This selection must guarantee not only the required parameters of the top layer, but also high stability and efficiency of the process. This requires multi-criteria optimization of the process and finding a compromise solution that meets the above presented conditions. In order to write the multi-criteria problem, the following designations were adopted:

- $E \subset R^m$, a set of permissible solutions (a range of process setting parameters);
- $z = (z_1, z_2, \dots, z_m) \in E$, acceptable solution;
- $f_i : E \rightarrow R$, i -th objective function ($i = 1, 2, \dots, k$);
- $(z) = (f_1(z), f_2(z))$, the objective function for a multi-criteria problem.

The problem of multi-criteria optimization of the selection of turning process parameters with tool cooling can be written in the form of (7):

$$\begin{cases} f_1(z) = f \rightarrow \max, \\ f_2(z) = v_c \rightarrow \max, \\ f_3(z) = F_c \rightarrow \min \\ f_4(z) = S_a \rightarrow \min \\ z \in E \end{cases} \quad (7)$$

However, in the case of dry turning (8):

$$\begin{cases} f_1(z) = f \rightarrow \min, \\ f_2(z) = v_c \rightarrow \max, \\ f_3(z) = T \rightarrow \min \\ f_4(z) = S_a \rightarrow \min \\ z \in E \end{cases} \quad (8)$$

One-criteria problem (9) is an i -th partial problem, where the vector $z^{i0} \in E$, in which the i -th objective function achieves the extremum searched. The vector (10) is a vector called the ideal (utopian) solution in the space of evaluation, while (11) is the ideal solution to the function (7) or (8).

$$f_i(z) \rightarrow \text{extremum}, z \in E \quad (9)$$

$$\varphi^o = (f_1(z^{1o}), f_2(z^{2o})) \quad (10)$$

$$z^o = (z^{1o}, z^{2o}) \quad (11)$$

The set of effective solutions usually contains many solutions. Therefore, the aim of the presented problem was to select one compromise (optimal) solution from a set of effective solutions. For this purpose, functions (7) and (8) has been reduced to a single-criterion form, with the scalarisation function $s : R^k \rightarrow R$ in the form (12):

$$\max(s(f_1(z), f_2(z))) : z \in E \quad (12)$$

Scalarisation of the function was carried out using the method of weighting the grades. Values of weights $u_i > 0$ of particular criteria f_i (fulfilling the condition $u_1 + u_2 + u_3 + u_4 = 1$), were assumed, and then the optimal solution of the problem was determined (13).

$$\max\left(\sum_{i=1}^k u_i f_i(z) : z \in E\right) \quad (13)$$

It is only possible to create a function $\varphi(z) = \sum_{i=1}^k u_i f_i(z)$ if all the values of objective functions are expressed in the same units and scales. Since the objective functions in this case were expressed in different scales of values, they were transformed into a dimensionless form (14).

$$f_i^u(z) = \frac{f_k(z) - \min(f_k(x) : x \in E)}{\max(f_k(x) : x \in E) - \min(f_k(x) : x \in E)} \quad (14)$$

Objective functions f_i^u takes values for $z \in E$ from the interval $[0, 1]$ and they are dimensionless. After the unitarisation, an optimal solution of the problem is determined according to (15):

$$\max\left(\sum_{i=1}^k u_i f_i^u(z) : z \in E\right) \quad (15)$$

The optimal solution of the function (15) is an effective solution to the multi-criteria problem. The form of the solution depends on the weight values u_i adopted. If during the calculations, it is assumed that all parameters for turning with cooling by the tool, are of equal importance ($u_1=0.25, u_2=0.25, u_3=0.25, u_4=0.25$), the objective function reaches the maximum value for the cutting speed $v_c = 236$ m/min and

feed rate $f = 0.132$ mm / rev. This enables reach the surface roughness to be $Sa = 1.66$ μm with the cutting force $F_c = 77.29$ N. Unfortunately, the obtained solution cannot be accepted due to the too high surface roughness inadequate for finishing turning. Therefore, during the further search for the solution to the problem (15), it was assumed that the surface roughness is of the greatest importance for the correct course of the process ($u_1=0.2, u_2=0.2, u_3=0.2, u_4=0.4$). Such an assumption makes it possible to obtain a compromise solution with the cutting speed $v_c = 240$ m / min and the feed $f = 0.1$ mm / rev (point P_1 Fig. 12). Machining with these parameters makes it possible to obtain a surface roughness of $Sa = 1.16$ μm with the cutting force $F_c = 63.26$ N.

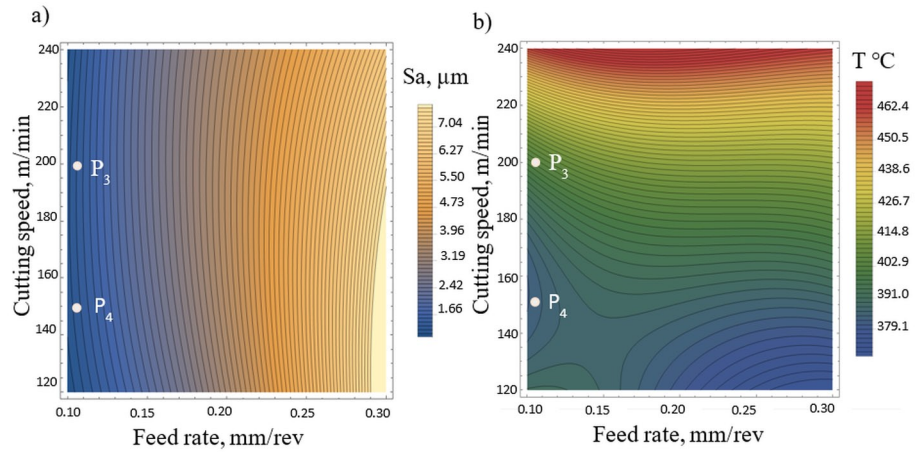

Fig. 13. The results of solving the problem of multi-criteria optimization of dry turning a) contour plot of the regression function for Sa , b) contour plot of the regression function for T

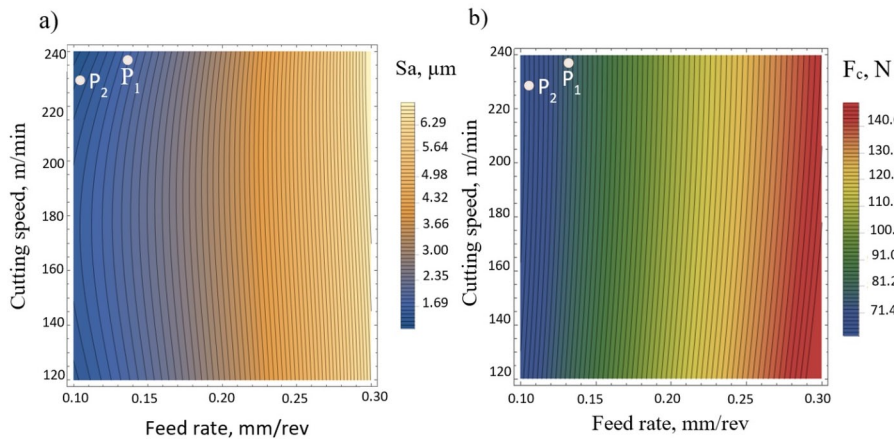

Fig. 12. The results of solving the problem of multi-criteria optimization in turning with the tool cooling a) contour plot of the regression function for Sa , b) contour plot of the regression function for F_c

In the case of dry turning, assuming the same significance of the parameters ($u_1=0.25, u_2=0.25, u_3=0.25, u_4=0.25$) allows to obtain the optimal solution for the cutting speed $v_c = 198$ m / min and the feed rate of $f = 0.1$ mm / rev (Point P_3 , Fig.13). It is makes possible to obtain a surface roughness of $Sa = 1.16$ μm at a temperature in the chip area of 400 $^{\circ}\text{C}$, to prevent the graphitization process. After assuming that the most important parameters determining the structure of the surface layer of the processed material are the roughness Sa and temperature T , modifying the weight values ($u_1=0.1, u_2=0.1, u_3=0.4, u_4=0.4$), it can be obtain another solution of the objective function (Point P_4 Fig. 13) ensuring surface roughness $Sa = 1.09$ μm at cutting speed $v_c = 150$ m / min and feed $f = 0.1$ mm / rev and a slightly lower temperature with value $T = 382.3$ $^{\circ}\text{C}$.

5. Conclusions

This paper presents the analysis of turning process of Ti-6Al-4V titanium alloy with using a polycrystalline diamond tool. The research were conducted with using RSM method for dry and cooling turning. The machining experiment, model development and result analysis revealed the following conclusions:

References

1. Abbas A.T., Sharma N., Anwar S., Luqman M., Tomaz I., Hegab H., Multi- response optimization in high-speed machining of Ti-6Al-4V using TOPSIS-fuzzy integrated approach. *Materials* 2020; 13 (5): 1104, <https://doi.org/10.3390/ma13051104>
2. ASTM B367-22 -Standard Specification for Titanium and Titanium Alloy Castings; ASTM International: West Conshohocken, PA, USA, 2022.
3. Ezugwu E.O., Bonney J., Da Silva R.B., Cakir O., Surface integrity of finished turned Ti6Al4V alloy with PCD tools using conventional and

- Surface roughness, both in turning with tool cooling and in dry turning, increases with increasing feed rate. During the tests, the lowest roughness value ($Sa = 1.12$ μm) in turning with cooling was obtained at a cutting speed $v_c = 240$ m / min and a feed rate $f = 0.1$ mm / rev, while in dry turning at a cutting speed $v_c = 120$ m / min and a feed rate $f = 0.1$ mm / rev ($Sa = 0.95$ μm).

- The temperature in the cutting zone with a feed in the range of $f = 0.2 \div 0.3$ mm / rev increases continuously with increasing cutting speed. At a feed rate of $f = 0.1$ mm / rev, the increase in the cutting speed from $v_c = 120$ m / min to $v_c = 180$ m / min doesn't cause a statistically significant increase in temperature.

- In dry turning, an increase in the feed rate leads to the appearance of a chemical reaction causing the release of a compound that adheres

adhesively to the surface of the part. This phenomenon is difficult to observe when measuring roughness with a contact and optical profilometer, which leads to deterioration of the performance of the part.

- Multi-criteria optimization of the turning process enables to obtain compromise (optimal) solutions. In the case of turning with cooling by the tool, the use of a cutting speed of $v_c = 230$ m / min and a feed rate of $f = 0.1$ mm / rev allows to obtain a surface roughness of $Sa = 1.16$ μm with the cutting force ($F_c = 77.29$ N), which does not significantly affect the accuracy of the part. During dry turning, a cutting speed of $v_c = 150$ m / min and a feed rate of $f = 0.1$ mm / rev enables a surface roughness of $Sa = 1.09$ μm at a chip formation temperature of 382.3°C to prevent the graphitization process.

Acknowledgment

This research is supported by the Polish Minister of Science and Higher Education under the name "Regional Excellence Initiative"- Grant No. 027 / RID / 2018/19 (2019-2022).

- high pressure coolant supplies. *International Journal of Machine Tools and Manufacture* 2007; 47 (6): 884-891, <https://doi.org/10.1016/j.ijmachtools.2006.08.005>
4. Fan W., Shen W., Zhang Q., Alfredo H.-S. Ang.: A new response surface method based on the adaptive bivariate cut-HDMM. *Engineering Computations* 2021; 38 (3): 1402-1431, <https://doi.org/10.1108/EC-06-2020-0343>
 5. Gao Y., Wu Y., Xiao J., Lu D.: An experimental research on the machinability of a high temperature titanium alloy BTi-6431S in turning process. *Manufacturing Rev.* 2018; 5 (12): 1-7, <https://doi.org/10.1051/mfreview/2018011>
 6. Grzesik W., Niesłony P., Habrat W. Investigation of the tribological performance of AlTiN coated cutting tools in the machining of Ti6Al4V titanium alloy in terms of demanded tool life. *Eksploracja i Niezawodność - Maintenance and Reliability* 2019; 21 (1): 153–158, <http://dx.doi.org/10.17531/ein.2019.1.17>
 7. Guo Z., Xu Ch., Wang X., Feng P., Zhang M. Determination of tool tip steady-state temperature in dry turning process based on artificial neural network. *Journal of Manufacturing Processes* 2022; 79: 600-613, <https://doi.org/10.1016/j.jmapro.2022.05.021>
 8. ISO 25178-2 2012 Geometrical Product Specifications (GPS)- Surface texture: areal- Part 2: Terms, definitions and surface texture parameters (Geneva: International Organization for Standardization)
 9. Kechagias J. D., Aslani K. E., Fountas N. A., Vaxevanidis N. M., Manolakos D. E.. A comparative investigation of Taguchi and full factorial design formachinability prediction in turning of a titanium alloy. *Measurement* 2020; 151 107213, <https://doi.org/10.1016/j.measurement.2019.107213>
 10. Khuri A.I.: A general overview of response surface methodology. *Biometrics & Biostatistics International Journal* 2017; 5(3): 87-93, DOI:10.15406/bbij.2017.05.00133
 11. Kowalczyk M., Then chip compression ratio analysis in the aspect of Ti-6Al-4V alloy turning with elevated cutting speeds. *Czasopismotechniczne – Mechanika*, 2012; 109 (8): 55-69.
 12. Kuntoğlu M., Sağlam H. ANOVA and fuzzy rule based evaluation and estimation of flank wear, temperature and acoustic emission in turning. *CIRP Journal of Manufacturing Science and Technology* 2021; 35 (3): 589-603, <https://doi.org/10.1016/j.cirpj.2021.07.011>
 13. Lampropoulos A. D., Markopoulos A. P., Manolakos D. E. Modeling of Ti6Al4V Alloy Orthogonal Cutting with Smooth Particle Hydrodynamics: A Parametric Analysis on Formulation and Particle Density. *Metals* 2019; 9 (4), <https://doi.org/10.3390/met9040388>
 14. Le Coz G., Fischer M., Piquard R., D'Acunto A., Laheurte P., Dudzinski D.: Micro cutting of Ti-6Al-4V parts produced by SLM Process. *Procedia CIRP* 2017; 58: 228 -232, <https://doi.org/10.1016/j.procir.2017.03.326>
 15. Mia M., Khan M. A., Dhar N. R. Study of surface roughness and cutting forces using ANN, RSM and ANOVA in turning of Ti-6Al-4V under cryogenic jets applied at flank and rake faces of coated WC tool. *The International Journal of Advanced Manufacturing Technology* 2017; 93: 975–991, DOI 10.1007/s00170-017-0566-9
 16. Mierzejewska Ż., Kuptel P., Sidun J. Analysis of the surface condition of removed bone implants. *Eksploracja i Niezawodność - Maintenance and Reliability* 2016; 18 (1): 65–72, <http://dx.doi.org/10.17531/ein.2016.1.9>.
 17. Myers, R. H., Montgomery, D. C. *Response Surface Methodology: Product and Process Optimization Using Designed Experiments*. 2nd Edition, John Wiley & Sons, New York. 2002.
 18. Narojczyk J., Moroz D., Siemiątkowski Z., Machining titanium alloy Ti-6Al-4V implanted carbide tools. *Mechanik* 2015; 3: 359-362, <http://dx.doi.org/10.17814/mechanik.2015.3.152>
 19. Ranganath M.S., Vipin H., Optimization of process parameters in turning operation using response surface methodology: a review. *International Journal of Emerging Technology and Advanced Engineering* 2014; 4 (10): 351-360.
 20. Sivam S. P. S. S., Rajendra Kumar S., Rajasekaran A., Karupiah S. Prediction Model of Setting Input Parameters for Turning Operation Ti-6Al-4V by Fuzzy Rule based Modeling. 2017 IEEE International Conference on Power, Control, Signals and Instrumentation Engineering (ICPCSI) 2017; 1343-1349, doi:10.1109/ICPCSI.2017.8391929
 21. Stachurski W., Midera S., D. Ostrowski. Influence of cutting parameters during turning process of aerospace industry alloy Ti-6Al-4V ELI (Grade 23) on cutting forces and surface roughness of the workpiece. *Mechanik* 2015; 8-9: 365-373, DOI: 10.17814/mechanik.2015.8-9.446
 22. Stachurski W., Ostrowski D.: Influence of cutting parameters during turning process of aerospace industry alloy Ti-6Al-4V ELI (Grade 23) on cutting forces and surface roughness of the workpiece. *Mechanik* 2016; 8-9: 1032-1033, <http://dx.doi.org/10.17814/mechanik.2016.8-9.233>
 23. Sulaiman M.A. et al., Optimization of turning parameters for titanium alloy Ti-6Al-4V ELI using the response surface method (RSM). *Journal of Advanced Manufacturing Technology (JAMT)* 2013; 7 (2): 11-28.
 24. Suresh R. Nipnikar: Effect of Process Parameters during Turning of Ti6Al4V-ELI in Dry and MQL Environments. *International Journal of Engineering Research & Technology (IJERT)* 2020; 8 (14): 190-194.
 25. Surya M. S. Optimization of turning parameters while turning Ti-6Al-4V titanium alloy for surface roughness and material removal rate using response surface methodology. *Materials Today: Proceedings* 2022; 62: 3479-3484, <https://doi.org/10.1016/j.matpr.2022.04.300>
 26. Surya M.S., Vepa K.S., Karanam M., Optimization of machining parameters using ANOVA and grey relational analysis while turning Aluminium 7075. *International Journal of Recent Technology and Engineering* 2019; 8 (2): 5682–5686, DOI: 10.35940/ijrte.B3038.078219
 27. Tatar K., Sjöberg S., Andersson N.: Investigation of cutting conditions on tool life in shoulder milling of Ti6Al4V using PVD coated micro-grain carbide insert based on design of experiments. *Heliyon* 2020; 6: 1-7, <https://doi.org/10.1016/j.heliyon.2020.e04217>
 28. Veiga C., Davim J. P., Loureiro A. Properties and applications of titanium alloys: A brief review. *Reviews on Advanced Materials Science* 2012; 32: 14-34.
 29. Xiaobo Z. Comparison of response surface method and Kriging method for approximation modeling 2017; 2nd International Conference on Power and Renewable Energy (ICPRE), DOI:10.1109/ICPRE.2017.8390502
 30. Ziberov M., Bacci da Silva M., Mark Jackson M., Wayne N.P. Hung. Effect of Cutting Fluid on Micromilling of Ti-6Al-4V Titanium Alloy. *Procedia Manufacturing* 2016; 5: 332-347, <https://doi.org/10.1016/j.promfg.2016.08.029>