

Method of determining the degree of liquid aeration in a variable capacity displacement pump

Zygmunt Paszota, Prof.
Gdansk University of Technology, Poland

ABSTRACT



The Author concludes, that there is a possibility of determining a concrete value of the liquid aeration coefficient ε during the pump operation by finding such value of ε with which the increase $\Delta M_{P_{mi}|\Delta p_{pi} = p_n, q_{pgv}}$ of torque of mechanical losses is proportional to the indicated torque $M_{P_{pi}|\Delta p_{pi} = p_n, q_{pgv}}$ determined with a fixed value $\Delta p_{pi} = cte$ of increase of pressure in the pump working chambers. The fixed value Δp_{pi} assumed in searching the liquid aeration coefficient ε equals to the nominal pump operation pressure p_n ($\Delta p_{pi} = cte = p_n$).

The increase $\Delta M_{P_{mi}|\Delta p_{pi} = p_n, q_{pgv}}$ of torque of mechanical losses with a fixed value of Δp_{pi} ($\Delta p_{pi} = cte$) is proportional to the pump geometrical working capacity q_{pgv} , therefore: only with taking into account the aeration coefficient ε of liquid displaced by the pump the relation $\Delta M_{P_{mi}|\Delta p_{pi} = p_n, q_{pgv}} \sim q_{pgv}$ can be obtained from tests. The method, proposed by the Author, of determining the working liquid aeration coefficient ε , is presented in this paper and has been practically applied for the first time by Jan Koralewski in his investigations of the influence of viscosity and compressibility of aerated hydraulic oil on volumetric and mechanical losses in a pump of HYDROMATIK A7V.58.1.R.P.F.00 type [8, 9].

Key words: hydrostatic drive; variable capacity displacement pump; liquid aeration; method of determining the degree of liquid aeration

INTRODUCTION

In references [1– 4] the Author evaluated the effect of working liquid compressibility on the picture of volumetric and mechanical losses in a high-pressure variable capacity displacement pump. The considerations are based on the assumptions made in the, developed by the Author, theoretical and mathematical models of torque of mechanical losses in a pump used in a hydrostatic drive [5 –7]. It is assumed in the models, that increase $M_{P_{pi}|\Delta p_{pi} = p_n, q_{pgv}}$ of torque of mechanical losses in the pump „working chambers - shaft” assembly is proportional to torque M_{P_i} indicated in the pump working chambers:

$$\Delta M_{P_{mi}|\Delta p_{pi}} \sim M_{P_i}$$

In references [1– 4] the Author introduced also a working liquid compressibility coefficient $k_{lc|p_n}$. Coefficient $k_{lc|p_n}$ determines the decrease, as an effect of liquid compressibility, of active volume of working liquid displaced during one pump shaft revolution with the increase $\Delta p_{pi} = p_n$ of pressure in the

working chambers equal to the pump nominal pressure p_n , compared with active volume equal to theoretical working capacity q_{pt} or geometrical working capacity q_{pgv} per one shaft revolution, determined with the increase Δp_{pi} of pressure in the working chambers equal to zero – $\Delta p_{pi} = 0$:

$$k_{lc|p_n} = \frac{q_{pt} - q_{pt|\Delta p_{pi} = p_n}}{q_{pt}}$$

and

$$k_{lc|p_n} = \frac{q_{pgv} - q_{pgv|\Delta p_{pi} = p_n}}{q_{pgv}} = \frac{b_P q_{pt} - b_P q_{pt|\Delta p_{pi} = p_n}}{b_P q_{pt}}$$

The Author has also concluded that it is possible to evaluate the effect of liquid compressibility coefficient $k_{lc|p_n}$ on the value of increase $\Delta M_{P_{mi}|\Delta p_{pi} = p_n, q_{pgv}}$ of torque of mechanical losses in the pump „working chambers - shaft” assembly and to evaluate the effect of $k_{lc|p_n}$ coefficient on the value of the coefficient of volumetric losses in the pump working chambers due to leakage.

Searching the value of liquid compressibility coefficient $k_{lc|p_n}$, which with the increase Δp_{pi} of pressure in working chambers, equal to the pump nominal pressure p_n , will cause an increase $\Delta M_{P_{mi}|\Delta p_{pi} = p_n, q_{pgv}}$ of torque of mechanical losses proportional to q_{pgv} , i.e. to the indicated torque $M_{P_{mi}|\Delta p_{pi} = p_n, q_{pgv}}$ the Author determined, in the pump HYDROMATIK A7V.58.1.R.P.F.00 type, tested by Jan Koralewski in his doctor dissertation [8] the approximate value of the oil compressibility coefficient during the tests as equal to $k_{lc|32 MPa} = 0.030$.

Taking into account the working liquid compressibility evaluated by the coefficient $k_{lc|32 MPa} = 0.030$. Author determined approximate values of new coefficients of volumetric and mechanical losses in the tested pump.

The Author concludes, that there is a possibility of determining a concrete value of the liquid aeration coefficient ε during the pump operation by finding such value of ε with which the increase $\Delta M_{P_{mi}|\Delta p_{pi} = p_n, q_{pgv}}$ of torque of mechanical losses is proportional to the indicated torque $M_{P_{mi}|\Delta p_{pi} = p_n, q_{pgv}}$ determined with a fixed value $\Delta p_{pi} = cte$ of increase of pressure in the pump working chambers. The fixed value Δp_{pi} assumed in searching the liquid aeration coefficient ε equals to the nominal pump operation pressure p_n ($\Delta p_{pi} = cte = p_n$).

The increase $\Delta M_{P_{mi}|\Delta p_{pi} = p_n, q_{pgv}}$ of torque of mechanical losses with a fixed value of Δp_{pi} ($\Delta p_{pi} = cte$) is proportional to the pump geometrical working capacity q_{pgv} , therefore:

only with taking into account the aeration coefficient ε of liquid displaced by the pump the relation $\Delta M_{P_{mi}|\Delta p_{pi} = p_n, q_{pgv}} \sim q_{pgv}$ can be obtained from tests.

The method, proposed by the Author, of determining the working liquid aeration coefficient ε , is presented in this paper and has been practically applied for the first time by Jan Koralewski in his investigations of the influence of viscosity and compressibility of aerated hydraulic oil on volumetric and mechanical losses in a pump of HYDROMATIK A7V.58.1.R.P.F.00 type [8, 9].

COMPRESSIBILITY OF WORKING LIQUID IN THE PUMP

Compressibility of liquid at a given temperature is characterized by variation of its mass density ρ as a function of pressure p . In order to facilitate the calculations, the curve of variation $\rho = f(p)$ is represented by an approximate algebraic relation. Most often a linear approximation is used:

$$\frac{\Delta \rho}{\rho} = \frac{\Delta p}{B} \quad (1)$$

It may be said, that relation (1) defines a **modulus B of the liquid volume elasticity** valid for a certain temperature and for a certain pressure.

Numerical indications regarding the value of B of hydraulic oils are the following [10]:

- at the normal temperature (20 °C), close to $B = 1500$ MPa for the used hydraulic oils,
- B increases with the pressure (by about 1% every 2 MPa up to 20 MPa for the used oils ($a_p = 0.005/1$ MPa)),

- B decreases when the temperature increases (about 1% every 2 °C up to 100 °C for the used oils ($a_\theta = -0.005/1$ °C)).

In working chambers of the tested piston pump [8, 9], during their connection with the inlet channel, was slight overpressure $p_{P_{1ia}} \approx 0.05$ MPa (i.e. absolute pressure $p_{P_{1ia}} \approx 0.15$ MPa). Let's assume that the value of modulus B of the hydraulic oil volume elasticity, at the temperature $\vartheta = 20$ °C, equals to:

$$B_{|p_{P_{1ia}} \approx 0.15 \text{ MPa}; \vartheta = 20 \text{ °C}} = 1500 \text{ MPa} \quad (2)$$

Therefore, the dependence of modulus B of oil on the increase Δp_{pi} of pressure in the working chambers and on the increase $\Delta \vartheta$ of oil temperature may be described by the expression:

$$B = B_{|p_{P_{1ia}} \approx 0.15 \text{ MPa}; \vartheta = 20 \text{ °C}} (1 + a_p \Delta p_{pi} + a_\theta \Delta \vartheta) \quad (3)$$

Modulus B of hydraulic oil volume elasticity decreases very quickly when oil is aerated, i.e. when the oil aeration coefficient ε is greater than zero ($\varepsilon > 0$).

The oil aeration coefficient ε is the ratio of volume V_a of air to volume $V_0 = V_o + V_a$ of mixture of oil volume V_o and air volume V_a ($\varepsilon = V_a/V_0 = V_a/(V_o + V_a)$). The oil aeration coefficient ε is determined at the absolute pressure $p_{P_{1ia}}$ in the pump working chambers during their connection with the inlet channel.

Let's suppose, that volume V_0 of aerated oil in the pump working chambers, at initial absolute pressure $p_{P_{1ia}}$ in the chambers (Fig. 6), contains a volume of air equal $V_a = \varepsilon V_0$ and a volume of oil equal $V_o = (1 - \varepsilon)V_0$.

An increase Δp_{pi} of pressure in the pump working chambers causes a decrease of the oil and air mixture volume by the value ΔV (assuming a hypothesis of compression of air $pV_a = cte$) equal to:

$$\Delta V = \Delta V_o + \Delta V_a = \frac{V_o}{B} \Delta p_{pi} + \frac{V_a}{p_{P_{1ia}} + \Delta p_{pi}} \Delta p_{pi} \quad (4)$$

If the aeration coefficient ε is small, which is a general case, V_o is close to V_0 . Therefore it can be written:

$$\Delta V = V_0 \left(\frac{1}{B} + \frac{\varepsilon}{p_{P_{1ia}} + \Delta p_{pi}} \right) \Delta p_{pi} \quad (5)$$

Therefore, **with the oil aeration coefficient ε greater than zero ($\varepsilon > 0$), modulus B of oil volume elasticity must be replaced by modulus B' of volume elasticity** defined by the relation:

$$\frac{1}{B'} = \frac{1}{B} + \frac{\varepsilon}{p_{P_{1ia}} + \Delta p_{pi}} \quad (6)$$

or, in the conditions of changing pressure and temperature of the aerated oil, by the relation:

$$\frac{1}{B'} = \frac{1}{B_{|p_{P_{1ia}} \approx 0.15 \text{ MPa}, \vartheta = 20 \text{ °C}} (1 + a_p \Delta p_{pi} + a_\theta \Delta \vartheta)} + \frac{\varepsilon}{p_{P_{1ia}} + \Delta p_{pi}} \quad (7)$$

$$B|_{p_{P1ia} \approx 0.15 \text{ MPa}, \vartheta = 20^\circ \text{C}} = 1500 \text{ MPa} \quad a_p = 0.005/1 \text{ MPa} \quad a_\vartheta = -0.005/1^\circ \text{C}$$

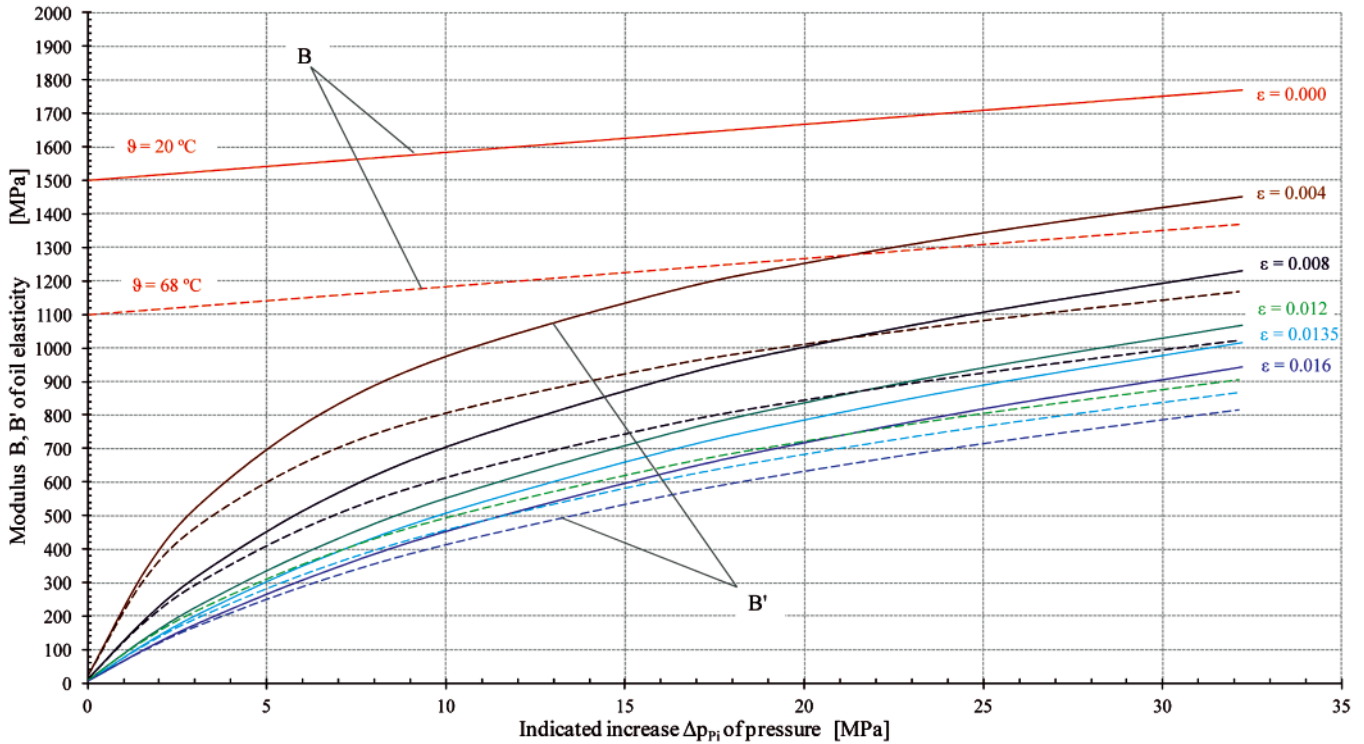

Fig. 1. Modulus B of volume elasticity of non-aerated hydraulic oil ($\varepsilon = 0$) and modulus B' of aerated oil ($\varepsilon > 0$) as relations dependent on indicated increase Δp_{pi} of pressure in the pump working chambers, with limit values $\vartheta = 20^\circ \text{C}$ (continuous line) and $\vartheta = 68^\circ \text{C}$ (dashed line) of hydraulic oil temperature adopted during the investigations [8, 9]. It was assumed that modulus B of oil volume elasticity at absolute pressure $p_{P1ia} \approx 0.15 \text{ MPa}$ in the pump working chambers during their connection with the inlet channel and at oil temperature $\vartheta = 20^\circ \text{C}$ is equal to $B = 1500 \text{ MPa}$. Also assumed was the value of coefficient $a_p = 0.005/1 \text{ MPa}$ of the change of modulus B of oil due to increase Δp_{pi} of pressure in the working channels and coefficient $a_\vartheta = -0.005/1^\circ \text{C}$ of the change of modulus B due to change of oil temperature ϑ

Fig. 1 presents the modulus B of volume elasticity of non-aerated hydraulic oil ($\varepsilon = 0$) and modulus B' of aerated oil ($\varepsilon > 0$) as relations dependent on indicated increase Δp_{pi} of pressure in the pump working chambers, with limit values $\vartheta = 20^\circ \text{C}$ and $\vartheta = 68^\circ \text{C}$ of oil temperature adopted during the investigations [8, 9].

The displacement pump with variable geometric working capacity q_{pgv} per one shaft revolution is tested with different fixed values of q_{pgv} .

Variable (set during the test) geometrical working capacity q_{pgv} of working chambers per one shaft revolution equals to the difference between maximum chambers capacity (capacity increasing to that maximum value during connection of the chamber with the pump inlet channel) and minimum chamber capacity (capacity decreasing to that value during connection of the chambers with the pump outlet (discharge) channel). The initial volume V_0 of oil (Fig. 6), which is compressed due to increase Δp_{pi} of pressure in the pump chambers, corresponding to setting q_{pgv} of the variable geometrical working capacity, is in a variable capacity pump equal to:

$$V_0 = 0.5q_{pt} + 0.5q_{pgv} \quad (8)$$

When the variable (set) geometrical working capacity q_{pgv} reaches the maximum value equal to the pump theoretical working capacity q_{pt} ($q_{pgv} = q_{pt}$), volume V_0 of compressed oil is equal to:

$$V_0 = 0.5q_{pt} + 0.5q_{pt} = q_{pt} \quad (9)$$

The change ΔV of liquid volume (Fig. 6), due to the liquid compression under the increase Δp_{pi} of pressure in the pump chambers, is equal to the loss q_{pvc} of pump capacity per one shaft revolution:

$$\Delta V = q_{pvc} \quad (10)$$

The loss q_{pvc} of pump capacity per one shaft revolution (Fig. 2), resulting from the compression of non-aerated (or aerated) oil at the setting q_{pgv} of geometrical variable working capacity, is determined (in reference to (5) and (6)) by the expression:

$$q_{pvc} = \frac{(0.5q_{pt} + 0.5q_{pgv})\Delta p_{pi}}{B'} \quad (11)$$

and with $q_{pgv} = q_{pt}$, by expression:

$$q_{pvc} = \frac{q_{pt} \Delta p_{pi}}{B'} \quad (12)$$

and, after replacing $1/B'$ by expression (7), by the formula:

$$q_{pvc} = (0.5q_{pt} + 0.5q_{pgv}) \cdot$$

$$\left[\frac{1}{B|_{p_{P1ia} \approx 0.15 \text{ MPa}, \vartheta = 20^\circ \text{C}} (1 + a_p \Delta p_{pi} + a_\vartheta \Delta \vartheta)} + \frac{\varepsilon}{p_{P1ia} + \Delta p_{pi}} \right] \Delta p_{pi} \quad (13)$$

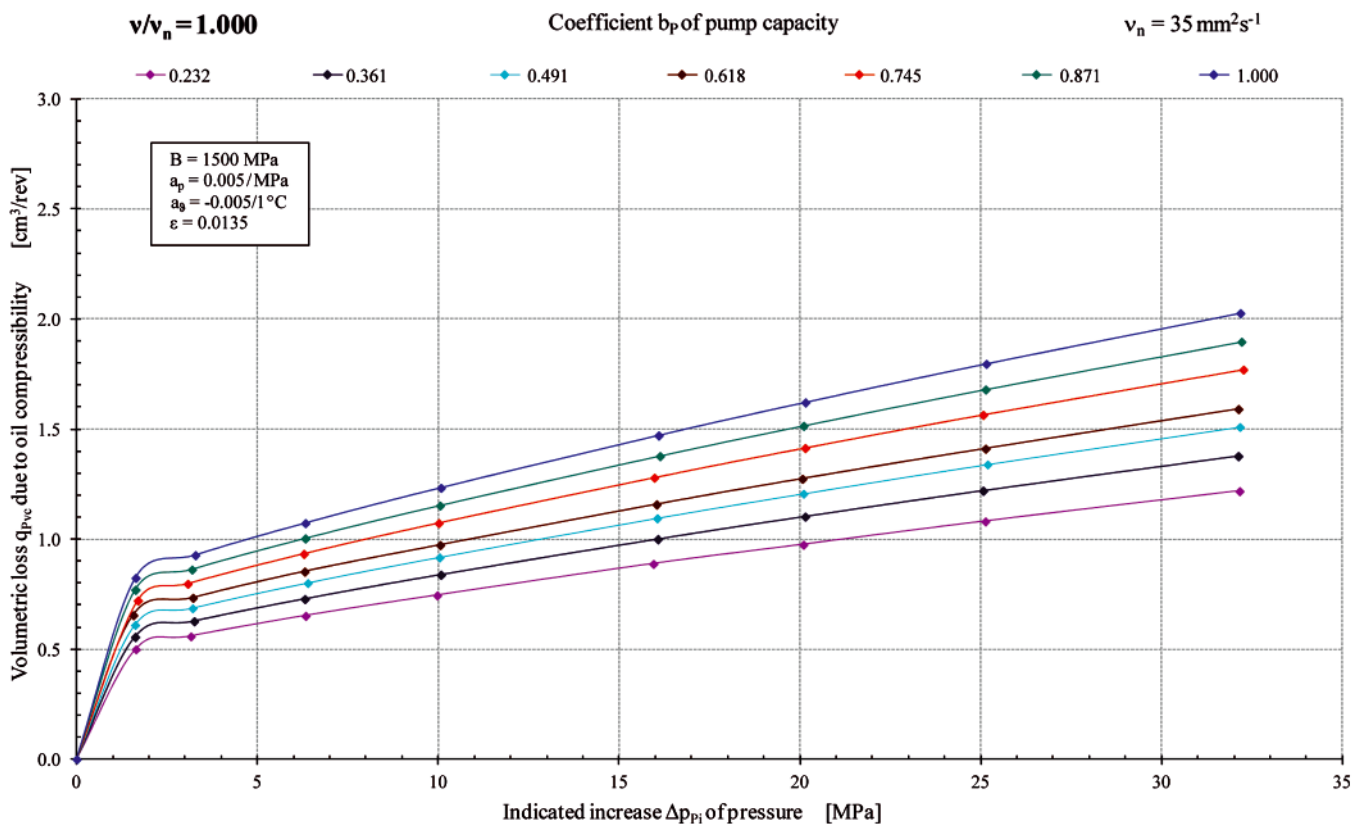

Fig. 2. Loss q_{pvc} of pump capacity during one pump shaft revolution due to compressibility of aerated ($\epsilon = 0.0135$) liquid, decreasing the active volume of liquid displaced by the pump compared with the theoretical working capacity q_{pt} ($b_p = 1$) or geometrical working capacity q_{pgv} ($0 < b_p < 1$) (pump of HYDROMATIK A7V.DR.1.R.P.F.00 type) [8, 9]

and also, with $q_{pgv} = q_{pt}$, by the formula:

$$q_{pvc} = q_{pt}$$

$$\left[\frac{1}{B_{|p_{p_{lia}} \approx 0.15 \text{ MPa}, \vartheta = 20^\circ \text{C}} (1 + a_p \Delta p_{pi} + a_g \Delta \vartheta)} + \frac{\epsilon}{p_{p_{lia}} + \Delta p_{pi}} \right] \Delta p_{pi} \quad (14)$$

Fig. 2 presents an example (with assumed oil aeration coefficient $\epsilon = 0.0135$) of the results of calculations of the loss $q_{pvc} = f(\Delta p_{pi})$ of the tested pump capacity per one shaft revolution, taking into account formula (13) for setting q_{pgv} of the geometrical variable working capacity and formula (14) for the maximum setting $q_{pgv} = q_{pt}$, i.e. the case of pump theoretical working capacity.

The change of q_{pvc} as a function of indicated increase Δp_{pi} of pressure in the working chambers, presented in Fig. 2, takes into account the influence of changing volumes V_0 (Fig. 6) of compressed liquid in the working chambers, the changes being an effect of the principle of operation of a variable capacity q_{pgv} per one shaft revolution displacement pump (with variable b_p coefficient).

Loss q_{pvc} of pump capacity during one shaft revolution due to the liquid compressibility decreases the active liquid volume displaced by the pump compared with the theoretical working capacity q_{pt} or geometrical variable working capacity q_{pgv} (determined at $\Delta p_{pi} = 0$). This fact should be taken into account

in the evaluation of intensity $q_{pv} = Q_{pv}/n_p$ of volumetric losses in the working chambers as well as in the evaluation of increase $\Delta M_{pm|\Delta p_{pi}}$ of the torque of mechanical losses in the „working chambers - shaft” assembly, the losses caused by the increase Δp_{pi} of pressure in the pump working chambers with determined values of the chamber geometrical working capacity q_{pgv} .

In the considerations, notions have been introduced of **theoretical active working capacity $q_{pt|\Delta p_{pi} = p_n}$ and of geometrical active working capacity $q_{pgv|\Delta p_{pi} = p_n}$ as capacities the pump has in the working chambers at the increase Δp_{pi} of pressure in the chambers equal to the nominal pressure p_n of system operation.** The active working capacities $q_{pt|\Delta p_{pi} = p_n}$ and $q_{pgv|\Delta p_{pi} = p_n}$ can be determined from the equations:

$$q_{pt|\Delta p_{pi} = p_n} = q_{pt} - q_{pvc|p_n} \quad (15)$$

$$q_{pgv|\Delta p_{pi} = p_n} = q_{pgv} - q_{pvc|p_n} \quad (16)$$

Also a notion has been introduced of **the coefficient $k_{ic|p_n}$ of working liquid compressibility in the pump.**

Coefficient $k_{ic|p_n}$ of the working liquid compressibility in the pump determines the degree of decrease, as an effect of liquid compressibility (without taking into account the chamber leakage), of the liquid active volume displaced by the pump during one shaft revolution at the increase Δp_{pi} of pressure in the pump working chambers equal to the nominal pressure p_n of system operation, compared with the active volume displaced by the pump at $\Delta p_{pi} = 0$. Coefficient $k_{ic|p_n}$ is defined by the formulae:

$$k_{lc|p_n} = \frac{q_{Pt} - q_{Pt|\Delta p_{pi}=p_n}}{q_{Pt}} = \frac{q_{Pvc|p_n}}{q_{Pt}} \quad (17)$$

or:

$$k_{lc|p_n} = \frac{q_{Pgv} - q_{Pgv|\Delta p_{pi}=p_n}}{q_{Pgv}} = \frac{q_{Pvc|p_n}}{q_{Pgv}} \quad (18)$$

The knowledge of coefficient $k_{lc|p_n}$ of the liquid compressibility in the pump allows to evaluate numerically the subdivision of volumetric losses in the pump into the losses due to oil leakage in the working chambers and losses due to liquid compressibility.

In a variable capacity pump operating with setting q_{Pgv} of geometrical variable working capacity (determined at $\Delta p_{pi} = 0$), the coefficient $k_{lc|p_n}$ is described (in reference to (13) and (18)) by the formula:

$$k_{lc|p_n} = \frac{q_{Pvc|\Delta p_{pi}=p_n}}{q_{Pgv}} = \frac{0.5q_{Pt} + 0.5q_{Pgv}}{q_{Pgv}} \cdot \left[\frac{1}{B_{|p_{pia} \approx 0.15 \text{ MPa}, \vartheta=20^\circ \text{C}} (1 + a_p p_n + a_g \Delta \vartheta)} + \frac{\varepsilon}{p_{pia} + p_n} \right] p_n \quad (19)$$

and with $q_{Pgv} = q_{Pt}$ (in reference to (14) and (17)) by the formula:

$$k_{lc|p_n} = \frac{q_{Pvc|\Delta p_{pi}=p_n}}{q_{Pt}} = \left[\frac{1}{B_{|p_{pia} \approx 0.15 \text{ MPa}, \vartheta=20^\circ \text{C}} (1 + a_p p_n + a_g \Delta \vartheta)} + \frac{\varepsilon}{p_{pia} + p_n} \right] p_n \quad (20)$$

Therefore, in a displacement pump, operating at theoretical working capacity q_{Pt} per one shaft revolution, the working liquid compressibility coefficient $k_{lc|p_n}$ (formula (20)) is a combined effect of modulus B of hydraulic oil volume elasticity, oil aeration coefficient ε and also liquid temperature ϑ (increase $\Delta \vartheta$ to the reference temperature $\vartheta = 20^\circ \text{C}$) and absolute pressure p_{pia} in the working chambers during their connection with the inlet channel, as well as the system nominal pressure p_n .

In the same displacement pump operating with variable capacity q_{Pgv} per one shaft revolution, the value of working liquid compressibility coefficient $k_{lc|p_n}$ (formula (19)) increases in comparison with the value $k_{lc|p_n}$ during the pump operation with the theoretical working capacity q_{Pt} . This is an effect of the increased ratio of initial liquid volume (V_0 in Fig. 6) subjected to compression, i.e. the volume ($0.5q_{Pt} + 0.5q_{Pgv}$) (formula (8)), to the set working volume q_{Pgv} . **Therefore, decreasing the q_{Pgv} setting causes in a variable capacity displacement pump an increase of $k_{lc|p_n}$ coefficient (formula (19)).**

IMPORTANCE OF THE ACCURACY OF EVALUATION OF q_{Pt} AND q_{Pgv} FOR THE ACCURACY OF EVALUATION OF THE INTENSITY OF VOLUMETRIC LOSSES AND TORQUE OF MECHANICAL LOSSES IN THE PUMP

It is important, particularly during investigation of a pump of variable capacity per one shaft revolution, to determine precisely the theoretical capacity q_{Pt} per one pump shaft revolution and geometrical capacities q_{Pgv} per one pump shaft revolution. Geometrical capacities q_{Pgv} change in the $0 \leq q_{Pgv} \leq q_{Pt}$ range and the corresponding coefficients $b_p = q_{Pgv}/q_{Pt}$ of the pump capacity change in the $0 \leq b_p \leq 1$ range. Therefore, precise evaluation of the coefficient $b_p = q_{Pgv}/q_{Pt}$ depends on the precision of evaluation of q_{Pgv} and q_{Pt} .

The pump theoretical working capacity q_{Pt} and geometrical working capacities q_{Pgv} are determined at the indicated increase Δp_{pi} of pressure in the pump working chambers equal to zero ($\Delta p_{pi} = 0$); the working capacities are determined by approximation at the point $\Delta p_{pi} = 0$ of the line $q_p = Q_p/n_p = f(\Delta p_{pi})$ describing, at a pump constant setting (but the value of b_p coefficient unknown exactly), the capacity q_p displaced during one pump shaft revolution as dependent on the indicated increase Δp_{pi} . The line $q_p = f(\Delta p_{pi})$ runs through the measurement points obtained in the investigation.

Fig. 3 presents examples of dependence $q_p = f(\Delta p_{pi})$ of capacity q_p per one shaft revolution of an axial piston pump on the indicated increase Δp_{pi} of pressure in the working chambers at the coefficient $b_p = 1$ of pump capacity per one shaft revolution [8, 9]. These are examples of searching the theoretical working capacity q_{Pt} per one pump shaft revolution and also the evaluation of subdivision of the intensity q_{Pv} of volumetric losses per one shaft revolution into the volumetric loss q_{Pvl} due to oil leakage in the working chambers and volumetric loss q_{Pvc} due to compressibility of non-aerated (or aerated) oil.

Loss $q_{Pvc} = f(\Delta p_{pi})$ per one shaft revolution, determined from formula (13), due to liquid compressibility, occurring at setting q_{Pgv} of the pump variable geometrical working capacity (or from formula (14) at setting q_{Pt} of the pump theoretical working capacity) is added to capacity $q_p = f(\Delta p_{pi})$ per one shaft revolution shown by the line running through the test measurement points. The result of adding $q_{Pvc} = f(\Delta p_{pi})$ to $q_p = f(\Delta p_{pi})$ is pump capacity $q_{P \text{ without compressibility}} = f(\Delta p_{pi})$ as a difference between q_{Pgv} (or q_{Pt}) and the volumetric loss q_{Pvl} due to oil leakage (independent of the liquid compressibility):

$$(q_{P \text{ without compressibility}} = q_{Pvc} + q_p) = f(\Delta p_{pi}) \quad (21)$$

$$(q_{P \text{ without compressibility}} = q_{Pgv} \text{ (or } q_{Pt}) - q_{Pvl}) = f(\Delta p_{pi}) \quad (22)$$

Approximation of the $q_{P \text{ without compressibility}} = f(\Delta p_{pi})$ line at $\Delta p_{pi} = 0$ allows to determine the q_{Pgv} (or q_{Pt}):

$$q_{P \text{ without compressibility}} |_{\Delta p_{pi}=0} = q_{Pgv} \text{ (or } q_{Pt}) \quad (23)$$

As shown in Fig. 3, the pump theoretical working capacities q_{Pt} , at point $\Delta p_{pi} = 0$ of the $q_p = f(\Delta p_{pi})$ line, obtained from tests and including also the liquid compressibility, as well as of the

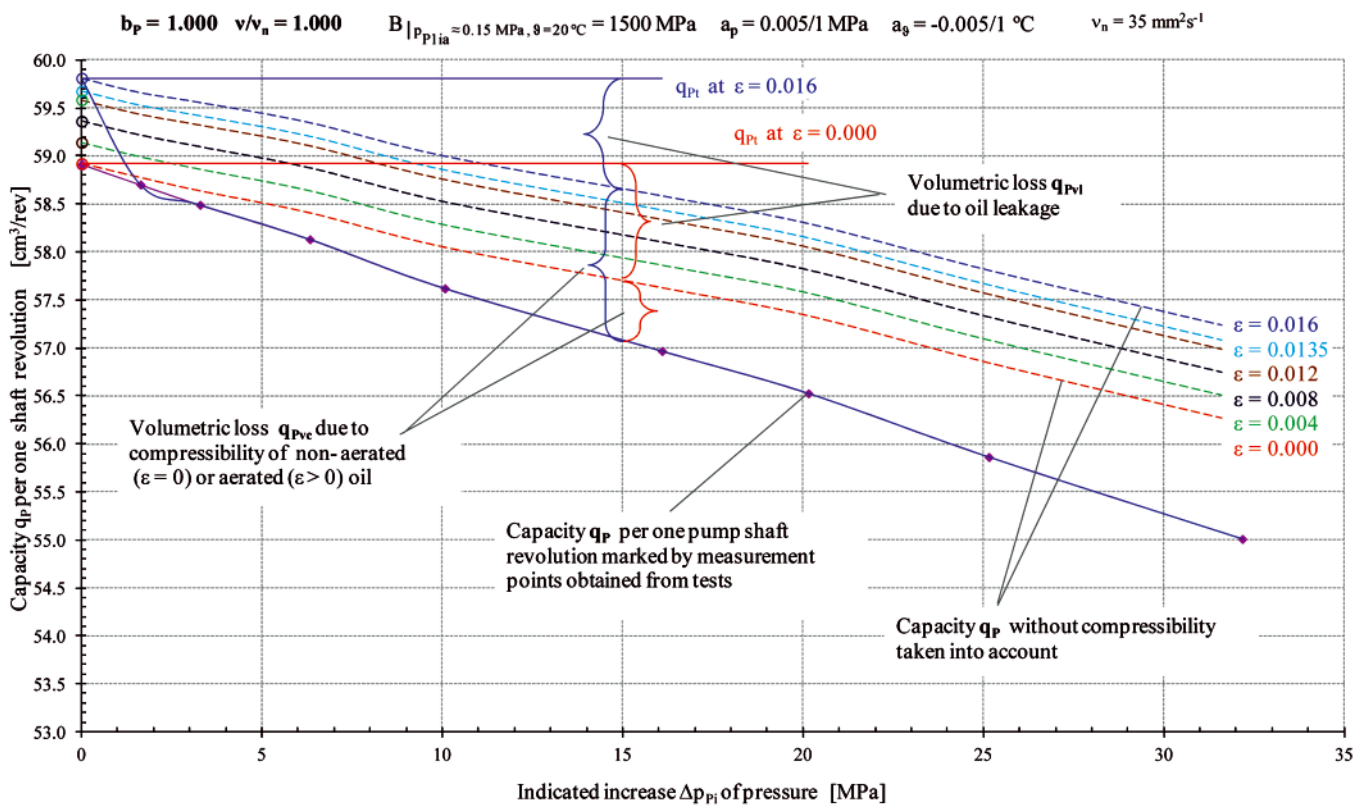

Fig. 3. Dependence of pump capacity q_p per one shaft revolution on the indicated increase Δp_{pi} of pressure in the working chambers, at the coefficient $b_p = 1$ of pump capacity; the values q_{Pgv} of geometrical working volume and q_{Pt} of theoretical working volume per one shaft revolution (determined at $\Delta p_{pi} = 0$) and subdivision of the intensity $q_{Pv} = q_{Pvl} + q_{Pvc}$ of volumetric losses per one shaft revolution into volumetric loss q_{Pvl} due to oil leakage in the chambers and volumetric loss q_{Pvc} due to compressibility of non-aerated (or aerated) oil dependent on the value of oil aeration coefficient ε ($\varepsilon = 0$ to 0.016); viscosity coefficient $\nu/v_n = 1$, oil temperature $\theta = 43$ °C (pump of the HYDROMATIK A7V.DR.1.R.P.F.00 type) [8, 9]

(q_p without compressibility = $q_{Pvc} + q_p$) = $f(\Delta p_{pi})$ line taking into account compressibility of non-aerated ($\varepsilon = 0$) oil, have practically the same value $q_{Pt} = 58.9$ cm³/rev. Approximation of the (q_p without compressibility = $q_{Pvc} + q_p$) = $f(\Delta p_{pi})$ line at $\Delta p_{pi} = 0$ point, taking into account the aerated oil compressibility, shows an increase of q_{Pt} value practically proportional to oil aeration coefficient ε . This is clearly presented in Fig. 4. For example, theoretical working capacity with $\varepsilon = 0.0135$, reaches the value $q_{Pt} = 59.57$ cm³/rev.

Fig. 5 presents the subdivision of volumetric losses $q_{Pv} = f(\Delta p_{pi})$ in the tested pump into loss $q_{Pvc} = f(\Delta p_{pi})$ due to liquid compressibility and loss $q_{Pvl} = f(\Delta p_{pi})$ due to oil leakage at different values of liquid aeration coefficient ε , with the theoretical working capacity q_{Pt} per one pump shaft revolution. The lines of $q_{Pvl} = f(\Delta p_{pi})$ loss due to oil leakage do not change at different oil aeration coefficient ε value, but lines $q_{Pvc} = f(\Delta p_{pi})$ due to oil compressibility differ clearly, as well as lines ($q_{Pv} = q_{Pvl} + q_{Pvc}$) = $f(\Delta p_{pi})$ of volumetric losses $q_{Pv} = f(\Delta p_{pi})$ as a sum of $q_{Pvl} = f(\Delta p_{pi})$ of loss due to leakage and $q_{Pvc} = f(\Delta p_{pi})$ of loss due to liquid compressibility.

During a careful investigation of a displacement pump pressing non-aerated working liquid, the accuracy of determining the theoretical working volume q_{Pt} and geometrical working volumes q_{Pgv} is of an order of one per mille. Accuracy of estimation of the value of coefficients b_p of pump capacity is then also very high.

The accuracy of evaluation of q_{Pt} and q_{Pgv} is significantly worse when the working liquid is aerated. This is an effect of

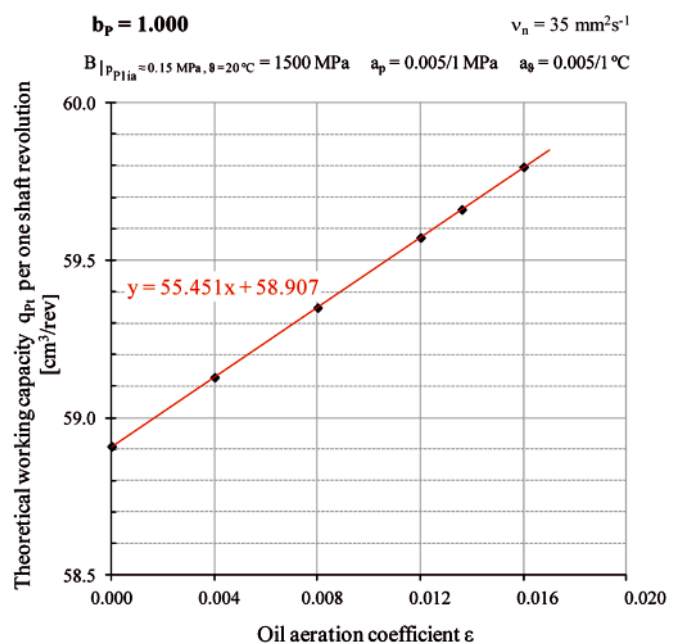

Fig. 4. Effect of evaluation of theoretical working capacity q_{Pt} per one pump shaft revolution resulting from assumption of aeration coefficient ε of the pump displaced oil; evaluation q_{Pt} (Fig. 3) is a result of approximation, at $\Delta p_{pi} = 0$. of the relation of pump capacity q_p per one shaft revolution to the indicated increase Δp_{pi} of pressure in the working chambers taking into account the aerated oil compressibility (at a given oil aeration coefficient ε) (pump HYDROMATIK A7V.DR.1.R.P.F.00 type) [8, 9]

the fact, that the aerated liquid in the working chambers filled during their connection with the low-pressure inlet channel decreases its volume because of great compressibility of non-

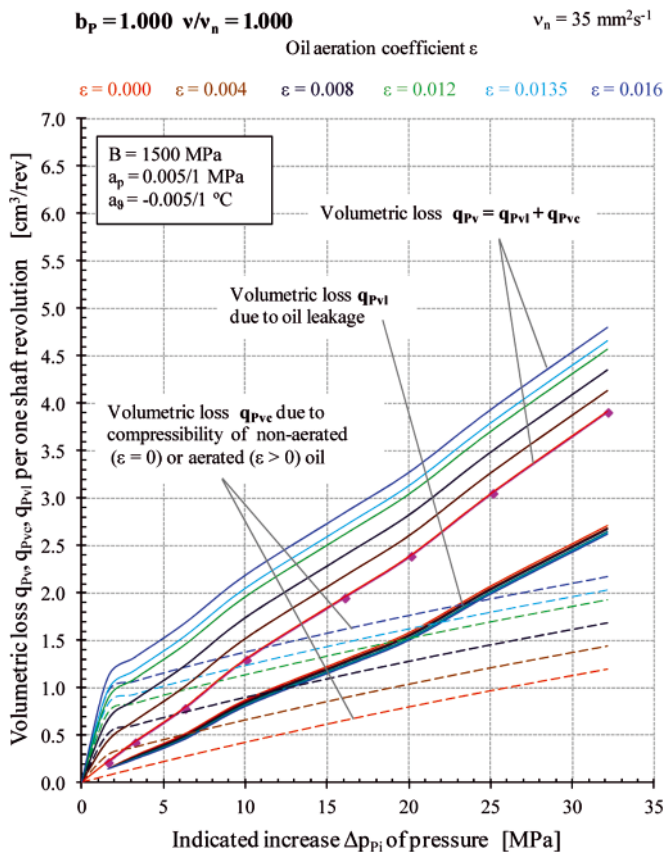

Fig. 5. Subdivision of volumetric loss $q_{Pv} = f(\Delta p_{Pi})$ in the pump into loss $q_{Pvc} = f(\Delta p_{Pi})$ due to oil compressibility and loss $q_{Pv1} = f(\Delta p_{Pi})$ due to oil leakage at different values of oil aeration coefficient ε and value $v/v_n = 1$ of oil viscosity coefficient in the tested pump with theoretical working capacity q_{Pt} ($b_p = 1$) (pump HYDROMATIK A7V.DR.1.R.P.F.00 type) [8, 9]

dissolved air in the liquid, after connection of the working chambers with the discharge channel where pressure may be only a little higher than in the inlet channel.

Without knowledge of the coefficient ε of aeration of the liquid flowing into the pump working chambers, it is impossible to determine the quantities q_{Pt} and q_{Pgv} precisely.

At the same time, precise knowledge of q_{Pt} and q_{Pgv} is important in evaluation of the volumetric and mechanical losses in the pump.

The intensity $q_{Pv} = Q_{Pv}/n_p$ of volumetric losses Q_{Pv} in the pump working chambers per one pump shaft revolution is evaluated as a difference between q_{Pt} (or q_{Pgv}) and q_P determined during the investigation at changing values of the indicated increase Δp_{Pi} of pressure in the chambers.

Increase $\Delta M_{Pm|\Delta p_{Pi}}$ of the torque of mechanical losses in the pump „working chambers - shaft” assembly, compared with torque $M_{Pm|\Delta p_{Pi}=0}$ of mechanical losses in the no-load pump, is an effect of increased friction forces in the assembly resulting from the influence of the torque M_{Pi} indicated in the working chambers upon the assembly and is proportional to M_{Pi} .

Increase $\Delta M_{Pm|\Delta p_{Pi}}$ of the torque of mechanical losses in the pump „working chambers - shaft” assembly is determined during the investigations as a difference $\Delta M_{Pm|\Delta p_{Pi}} = M_{Pm} + M_{Pm|\Delta p_{Pi}=0}$ between torque M_{Pm} of losses in the assembly and torque $M_{Pm|\Delta p_{Pi}=0}$ of losses in the assembly of a no-load pump.

Torque M_{Pm} of losses is determined as a difference $M_{Pm} = M_P - M_{Pi}$ between torque M_P measured directly on the shaft and torque M_{Pi} indicated in the working chambers. Therefore, extremely important, for determination of torque M_{Pm} of mechanical losses and of increase $\Delta M_{Pm|\Delta p_{Pi}}$ of torque of mechanical losses, is precision of determination of torque M_{Pi} indicated in the working chambers (defined by formulae (35) and (36)).

WORK OF THE DELIVERY OF COMPRESSED WORKING LIQUID DURING ONE PUMP SHAFT REVOLUTION AND TORQUE INDICATED IN THE PUMP WORKING CHAMBERS

In order to deliver compressed working liquid during one pump shaft revolution, a certain work E is required, which is a sum of:

- the work of compression itself – E_1 ,
- the work of displacement at constant pressure – E_2 .

Let's calculate the theoretical values (efficiencies equal to 1) of the two works. For that purpose, the pump delivering the compressed liquid is presented in a simplified way by a piston of cross-section S moving in a cylinder, which, by two valves R_1 and R_2 (acting as a distributor), can communicate with,

- space filled with liquid at constant absolute pressure p_{P1ia} ,
- volume C_2 filled with liquid at constant absolute pressure p_{P2ia} (Fig. 6).

Piston in Fig. 6 performs stroke from position x_0 to the bottom of cylinder i.e. to position 0

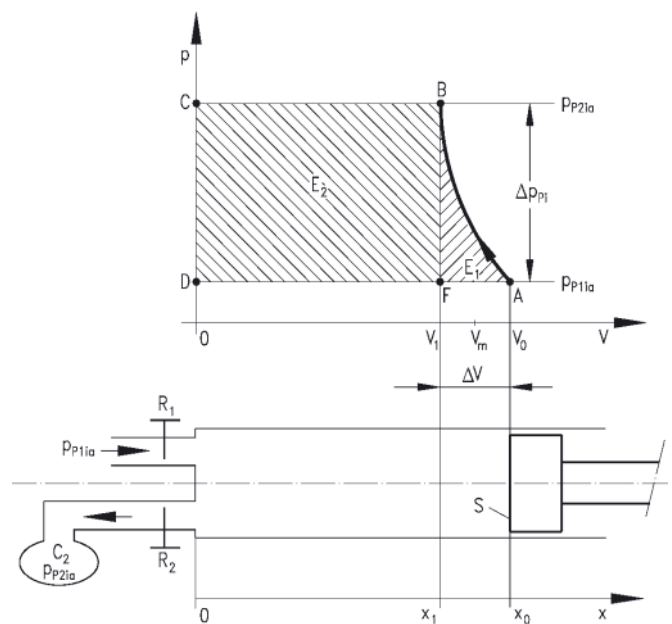

Fig. 6. Work of the delivery of compressed working liquid during one displacement pump shaft revolution (simplified diagram)

Initial position: piston at x_0 . Volume open to liquid at pressure p_{P1ia} : V_0 . R_1 opened, R_2 closed.

1st phase: R_1 is closed, piston pushed from x_0 to x_1 (volume V_1). This is the point where liquid, closed in the cylinder, achieves the pressure p_{P2ia} . The work delivered by the piston is **the work of compression:**

$$E_1 = - \int_{x_0}^{x_1} (p - p_{P1ia}) S dx = - \int_{V_0}^{V_1} (p - p_{P1ia}) dV \quad (24)$$

Work E_1 is represented by area ABFA.

2nd phase: R_2 is opened and the piston is pushed (in the case of $b_p = q_{pgv}/q_{pt} = 1$) from x_1 to 0. i.e., to the bottom of cylinder. The liquid is discharged into C_2 . The work delivered by the piston is **the work of displacement:**

$$E_2 = - \int_{x_1}^0 (p_{P2ia} - p_{P1ia}) S dx = - \int_{V_1}^0 (p_{P2ia} - p_{P1ia}) dV = (p_{P2ia} - p_{P1ia}) V_1 \quad (25)$$

Work E_2 is represented by area BCDFB.

3rd phase: R_2 is closed, R_1 opened and we return to the initial position. This operation is carried out without work performed by the pump.

The total work $E = E_1 + E_2$ is represented by the dashed areas in Fig. 6.

One of the definitions of the modulus B of liquid volume elasticity is the following:

$$\frac{\Delta V}{V} = - \frac{\Delta p}{B} \text{ where } V = - \frac{V}{B} dp \quad (26)$$

Therefore, the compression work is:

$$E_1 = - \int_{V_0}^{V_1} (p - p_1) dV = \int_{p_1}^{p_2} (p - p_1) \frac{V}{B} dp = \frac{V}{B} \frac{(p - p_1)^2}{2} \Big|_{p_1}^{p_2} \quad (27)$$

During operation of pump with theoretical capacity q_{pt} per one shaft revolution ($b_p = 1$), the change of V (Fig. 6) during compression work in relation to V_0 is small. The compression curve may be replaced by linear approximation and the V quantity in equation (27) by mean value $V_m = (V_0 + V_1)/2$:

$$E_1 = \frac{V_m}{B} \frac{(p_2 - p_1)^2}{2} \quad (28)$$

Therefore:

$$E_2 = V_1 (p_{P2ia} - p_{P1ia}) \text{ (acc. to (25))}$$

and:

$$\begin{aligned} E = E_1 + E_2 &= (p_2 - p_1) \left[V_1 + \frac{V_m (p_2 - p_1)}{2B} \right] = (p_2 - p_1) \left[V_1 + \frac{\Delta V}{2} \right] \\ E &= (p_2 - p_1) V_m \\ E &= V_m (p_{P2ia} - p_{P1ia}) \end{aligned} \quad (29)$$

Formula (29) describing the work E may be replaced by the expression:

$$E = \left[V_0 - \frac{\Delta V}{2} \right] (p_{P2ia} - p_{P1ia}) = \left[V_0 - \frac{\Delta V}{2} \right] \Delta p_{Pi} \quad (30)$$

In a real displacement pump with variable capacity per one shaft revolution, with the geometrical working capacity setting q_{pgv} , work E performed by the pump in the working chambers during one shaft revolution (after replacing in formula (30) the original volume V_0 by volume q_{pgv} , the change ΔV of liquid volume due to liquid compressibility by loss q_{pvc} of pump capacity during one shaft revolution (formula (8) and the loss q_{pvc} by formula (11)), is described by the expressions:

$$E = \left(q_{pgv} - \frac{q_{pvc}}{2} \right) \Delta p_{Pi} \quad (31)$$

and:

$$E = \left\{ 1 - \frac{1}{2} \left[\frac{1}{B_{|p_{P1ia} \approx 0.15 \text{ MPa}, \vartheta = 20^\circ \text{C}} (1 + a_p \Delta p_{Pi} + a_\vartheta \Delta \vartheta)} + \frac{\varepsilon}{p_{P1ia} + \Delta p_{Pi}} \right] \Delta p_{Pi} \right\} q_{pgv} \Delta p_{Pi} \quad (32)$$

and with $q_{p_{gv}} = q_{p_t}$ (in reference to (12)) by the expressions:

$$E = \left(q_{p_t} - \frac{q_{p_{vc}}}{2} \right) \Delta p_{p_i} \quad (33)$$

and:

$$E = \left\{ 1 - \frac{1}{2} \left[\frac{1}{B_{|p_{p_{1ia}} \approx 0.15 \text{ MPa}, \vartheta = 20^\circ \text{C}} (1 + a_p \Delta p_{p_i} + a_g \Delta \vartheta)} + \frac{\varepsilon}{p_{p_{1ia}} + \Delta p_{p_i}} \right] \Delta p_{p_i} \right\} q_{p_t} \Delta p_{p_i} \quad (34)$$

It has to be mentioned, that in formula (32), describing the work E performed by the pump with setting $q_{p_{gv}}$ per one shaft revolution, the $q_{p_{gv}}$ value is determined by approximation of the $(q_p + q_{p_{vc}}) = f(\Delta p_{p_i})$ line at point $\Delta p_{p_i} = 0$. At the same time, the formula (32) contains the value $q_{p_{vc}} = f(\Delta p_{p_i})$ describing a loss of capacity per one shaft revolution due to the liquid compressibility taking into account the change ΔV (Fig. 6) of liquid volume resulting from the variable capacity pump operation mode, i.e. the compressed volume V_0 (Fig. 6) equal to $V_0 = 0.5q_{p_t} + 0.5q_{p_{gv}}$.

Torque M_{p_i} indicated in the pump working chambers, corresponding to work E in the chambers during one shaft revolution, is then, with $q_{p_{gv}}$ setting, described by the formula:

$$M_{p_i} = \frac{E}{2\Pi} = \left\{ 1 - \frac{1}{2} \left[\frac{1}{B_{|p_{p_{1ia}} \approx 0.15 \text{ MPa}, \vartheta = 20^\circ \text{C}} (1 + a_p \Delta p_{p_i} + a_g \Delta \vartheta)} + \frac{\varepsilon}{p_{p_{1ia}} + \Delta p_{p_i}} \right] \Delta p_{p_i} \right\} \frac{q_{p_{gv}} \Delta p_{p_i}}{2\Pi} \quad (35)$$

and with $q_{p_{gv}} = q_{p_t}$ by the formula:

$$M_{p_i} = \frac{E}{2\Pi} = \left\{ 1 - \frac{1}{2} \left[\frac{1}{B_{|p_{p_{1ia}} \approx 0.15 \text{ MPa}, \vartheta = 20^\circ \text{C}} (1 + a_p \Delta p_{p_i} + a_g \Delta \vartheta)} + \frac{\varepsilon}{p_{p_{1ia}} + \Delta p_{p_i}} \right] \Delta p_{p_i} \right\} \frac{q_{p_t} \Delta p_{p_i}}{2\Pi} \quad (36)$$

METHOD OF DETERMINING THE WORKING LIQUID AERATION COEFFICIENT ε

As it so far has not been possible to determine the coefficient ε of aeration of the working liquid flowing into the pump, and therefore not possible to take the liquid compressibility into account, both at the small increase Δp_{p_i} of pressure in the pump working chambers and in the full range of increase Δp_{p_i} of pressure – up to the hydrostatic drive system nominal pressure p_n , **the pictures of volumetric losses and mechanical losses in the pump, determined by the applied methods, are deformed.** For instance, if the compressibility of working liquid, the liquid in fact aerated, is not taken into account, a picture of negative increase $\Delta M_{p_{m|\Delta p_{p_i}}}$ of torque of mechanical losses in the pump „working chambers - shaft” assembly is obtained as an effect of increased torque M_{p_i} indicated in the working chambers due to the increase of geometrical working volume $q_{p_{gv}}$ (of b_p coefficient), which is an illogical result (Fig. 7).

A method of determining the coefficient ε of working liquid aeration may be searching for value of ε which was used for determining the values $q_{p_{gv}}$ of geometrical working capacities causing an increase $M_{p_{m|\Delta p_{p_i}}}$ of torque of mechanical losses in the pump „working chambers - shaft” assembly proportional to torque M_{p_i} indicated in the working chambers (formula (35)), a torque M_{p_i} resulting from $q_{p_{gv}}$ and from ε at the constant value Δp_{p_i} of indicated increase of pressure in the chambers. It is assumed, that during searching for $q_{p_{gv}}$ and ε , the increase $M_{p_{m|\Delta p_{p_i}}}$ of the torque of mechanical losses is determined at a constant value of indicated increase Δp_{p_i} of pressure in the pump working chambers equal to the system nominal pressure p_n ($\Delta p_{p_i} = p_n$).

Therefore, it is assumed, that with a fixed value $\Delta p_{p_i} = p_n$ of the indicated increase of pressure in the pump working chambers, the increasing torque M_{p_i} in the chambers (formula (35)), described by the expression:

$$M_{p_i} = \left\{ 1 - \frac{1}{2} \left[\frac{1}{B_{|p_{p_{1ia}} \approx 0.15 \text{ MPa}, \vartheta = 20^\circ \text{C}} (1 + a_p p_n + a_g \Delta \vartheta)} + \frac{\varepsilon}{p_{p_{1ia}} + p_n} \right] p_n \right\} \frac{q_{p_{gv}} p_n}{2\Pi} \quad (37)$$

must be accompanied by proportional increase $\Delta M_{p_{m|\Delta p_{p_i} = p_n}}$ of torque of mechanical losses in the pump „working chambers - shaft” assembly:

$$\Delta M_{p_{m|\Delta p_{p_i} = p_n}; q_{p_{gv}}} \sim M_{p_i|\Delta p_{p_i} = p_n; q_{p_{gv}}} \quad (38)$$

or

$$\Delta M_{p_{m|\Delta p_{p_i} = p_n}; q_{p_{gv}}} \sim q_{p_{gv}} (b_p) \quad (39)$$

With fixed values of B , a_p , a_0 , ϑ , p_{Piia} and p_n , **expressions (38) and (39) can be obtained only with one value ε of the aeration coefficient**, which was assumed for determining of q_{Pgv} values and of the pump capacity b_p coefficient values.

Fig. 7 presents results of searching for the oil aeration coefficient ε during pump tests [8, 9].

With the assumption of non-compressible ($B = \infty$) and non-aerated ($\varepsilon = 0$) liquid, i.e. with the assumption of the liquid compressibility coefficient $k_{ic|p_i} = 0$ the picture of $\Delta M_{Pm|\Delta p_{P_i} = p_n} = f(M_{P_i|\Delta p_{P_i} = p_n})$ relation has the form of a descending straight line:

from value $\Delta M_{Pm} = 1.87 \text{ Nm}$ at $q_{Pgv} = 0$
to value $\Delta M_{Pm} = 0.53 \text{ Nm}$ at $q_{Pgv} = q_{Pt}$.

With the assumption of compressible and non-aerated ($\varepsilon = 0$) liquid, the picture of $\Delta M_{Pm|\Delta p_{P_i} = p_n} = f(M_{P_i|\Delta p_{P_i} = p_n})$ relation has the form of an ascending straight line:

from value $\Delta M_{Pm} = 1.86 \text{ Nm}$ at $q_{Pgv} = 0$
to value $\Delta M_{Pm} = 2.79 \text{ Nm}$ at $q_{Pgv} = q_{Pt}$.

With the assumption of compressible and aerated ($\varepsilon = 0.008$) liquid, the picture of $\Delta M_{Pm|\Delta p_{P_i} = p_n} = f(M_{P_i|\Delta p_{P_i} = p_n})$ relation has the form of an ascending straight line:

from value $\Delta M_{Pm} = 0.76 \text{ Nm}$ at $q_{Pgv} = 0$
to value $\Delta M_{Pm} = 1.77 \text{ Nm}$ at $q_{Pgv} = q_{Pt}$.

With the assumption of compressible and aerated ($\varepsilon = 0.016$) liquid, the picture of $\Delta M_{Pm|\Delta p_{P_i} = p_n} = f(M_{P_i|\Delta p_{P_i} = p_n})$ relation has the form of an ascending straight line:

from value $\Delta M_{Pm} = -0.35 \text{ Nm}$ at $q_{Pgv} = 0$
to value $\Delta M_{Pm} = 0.74 \text{ Nm}$ at $q_{Pgv} = q_{Pt}$.

With the oil aeration coefficient $\varepsilon = 0.0135$, the picture $\Delta M_{Pm|\Delta p_{P_i} = p_n; q_{Pgv}} = f(M_{P_i|\Delta p_{P_i} = p_n; q_{Pgv}})$ has the form of an ascending straight line:

from value $\Delta M_{Pm} = 0$ at $q_{Pgv} = 0$
to value $\Delta M_{Pm} = 1.03 \text{ Nm}$ at $q_{Pgv} = q_{Pt}$.

Figure 8 presents, in reference to results presented in figure 7, a linear relation of the increase $\Delta M_{Pm|\Delta p_{P_i} = p_n; q_{Pgv} = 0}$ of torque of mechanical losses to the assumed value of the oil aeration coefficient ε . **The relation shown in figure 8 allows to find with high accuracy the value of oil aeration coefficient ε , with which the increase $\Delta M_{Pm|\Delta p_{P_i} = p_n; q_{Pgv} = 0}$ of the torque of mechanical losses at $q_{Pgv} = 0$ ($b_p = 0$) equals zero:**

$$\Delta M_{Pm|\Delta p_{P_i} = p_n; q_{Pgv} = 0; \varepsilon = 0 \quad (40)$$

The oil aeration coefficient ε during the pump testing (pump HYDROMATIK A7V.DR.1.R.P.F.00 type) corresponding to the situation described by formula (40), had the value $\varepsilon = 0.0135$ [8, 9].

CONCLUSIONS

- The Author concludes, that there is a possibility of determining a concrete value of the liquid aeration coefficient ε during the pump operation by finding such value of ε with which the increase $\Delta M_{Pm|\Delta p_{P_i} = p_n; q_{Pgv}}$ of torque of mechanical losses is proportional to the indicated torque $\Delta M_{Pm|\Delta p_{P_i} = p_n; q_{Pgv}}$ determined with a fixed value $\Delta p_{P_i} = cte$ of increase of pressure in the pump working chambers.

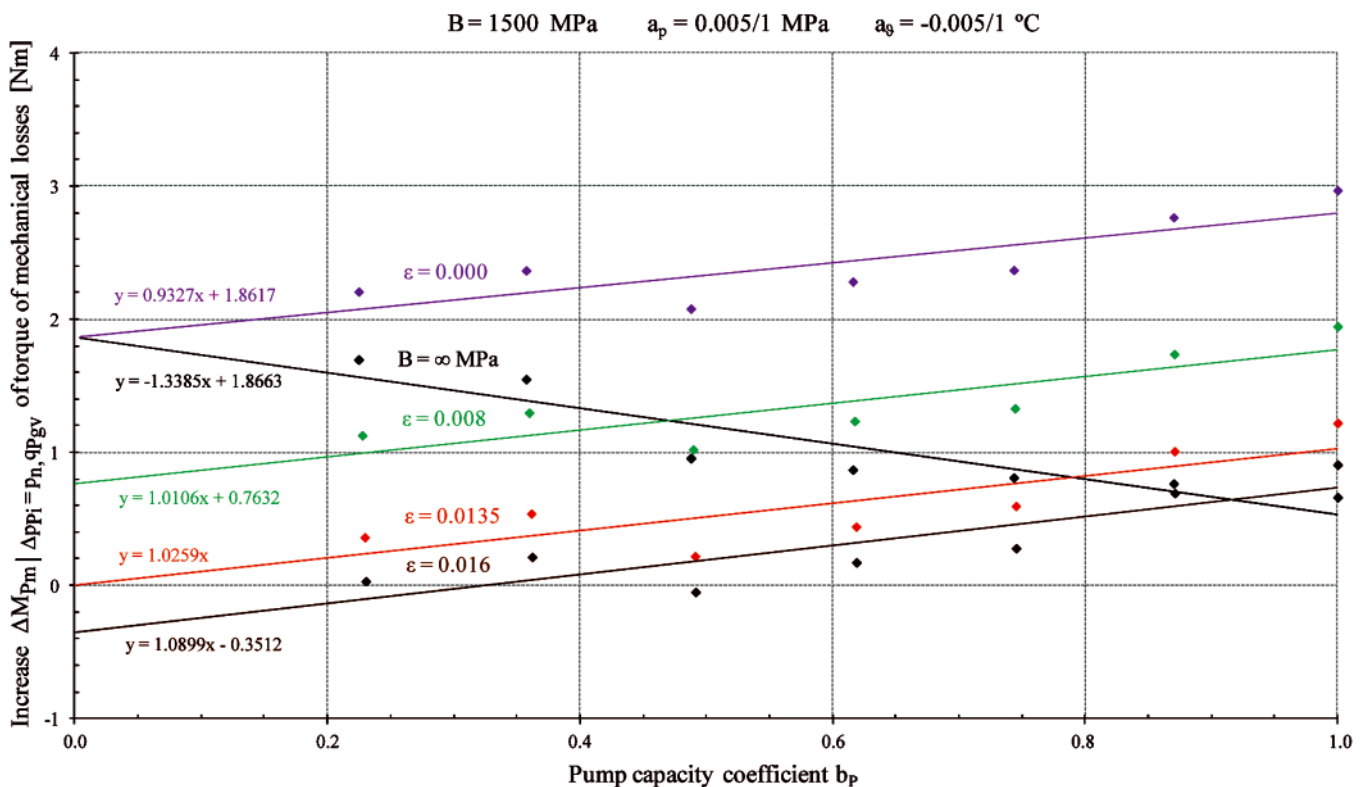

Fig. 7. Picture of the relations of increase $\Delta M_{Pm|\Delta p_{P_i} = 32 \text{ MPa}; q_{Pgv}}$ of torque of mechanical losses in the pump „working chambers - shaft” assembly (pump HYDROMATIK A7V.DR.1.R.P.F.00 type) to the geometrical working capacity q_{Pgv} (b_p coefficient) with assumed values of modulus B of hydraulic oil elasticity and oil aeration coefficient ε ; the line $\Delta M_{Pm|\Delta p_{P_i} = 32 \text{ MPa}; q_{Pgv}}$ corresponding to $\varepsilon = 0.0135$ is an effect of the straight line picture presented in Fig. 8 [8, 9]

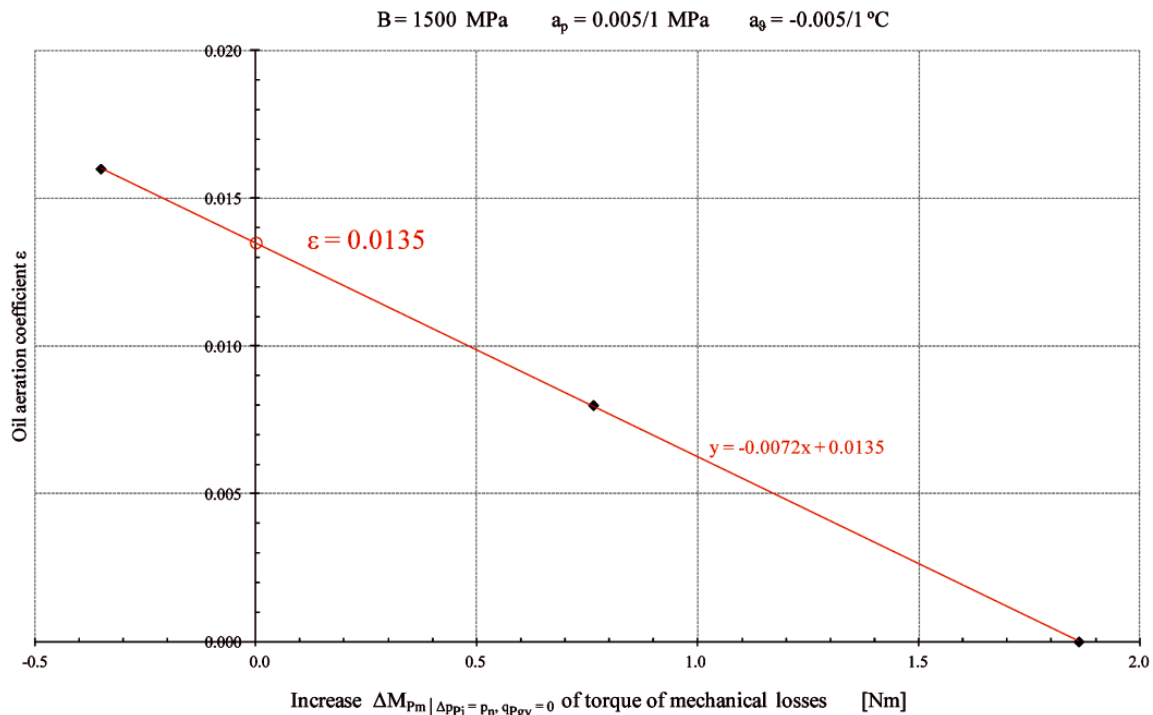

Fig. 8. Straight line relation of the oil aeration coefficient ϵ to the assumed increase $\Delta M_{p_m | \Delta p_{p_i} = p_n; q_{p_{gv}} = 0}$ of torque of mechanical losses (pump HYDROMATIK A7V.DR.1.R.P.F.00 type) [8, 9]

2. The fixed value Δp_{p_i} assumed in searching the liquid aeration coefficient ϵ equals to the nominal pump operation pressure p_n ($\Delta p_{p_i} = cte = p_n$).
3. The increase $\Delta M_{p_m | \Delta p_{p_i} = p_n; q_{p_{gv}}}$ of torque of mechanical losses with a fixed value of Δp_{p_i} ($\Delta p_{p_i} = cte$) is proportional to the pump geometrical working capacity $q_{p_{gv}}$, therefore: only with taking into account the aeration coefficient ϵ of liquid displaced by the pump the relation $\Delta M_{p_m | \Delta p_{p_i} = p_n; q_{p_{gv}}} \sim q_{p_{gv}}$ can be obtained from tests.
4. The method, proposed by the Author, of determining the working liquid aeration coefficient ϵ , is presented in this paper and has been practically applied for the first time by Jan Koralewski in his investigations of the influence of viscosity and compressibility of aerated hydraulic oil on volumetric and mechanical losses in a pump of HYDROMATIK A7V.58.1.R.P.F.00 type [8, 9].

BIBLIOGRAPHY

1. Paszota Z.: *Effect of the working liquid compressibility on the picture of volumetric and mechanical losses in a high pressure displacement pump used in a hydrostatic drive. Part I Energy losses in a drive system, volumetric losses in a pump* //International Scientific-Technical Conference Hydraulics and Pneumatics, Wrocław, 16 – 18 maja 2012 / Ośrodek Doskonalenia Kadr SIMP - Wrocław : ODK SIMP we Wrocławiu, 2012,
2. Paszota Z.: *Effect of the working liquid compressibility on the picture of volumetric and mechanical losses in a high pressure displacement pump used in a hydrostatic drive. Part II Mechanical losses in a pump* //International Scientific-Technical Conference Hydraulics and Pneumatics, Wrocław, 16 – 18 maja 2012 / Ośrodek Doskonalenia Kadr SIMP - Wrocław : ODK SIMP we Wrocławiu, 2012,
3. Paszota Z.: *Effect of the working liquid compressibility on the picture of volumetric and mechanical losses in a high pressure displacement pump used in a hydrostatic drive. Part I Energy losses in a drive system, volumetric losses in a pump* // Polish Maritime Research, Vol. 19, 2/2012
4. Paszota Z.: *Effect of the working liquid compressibility on the picture of volumetric and mechanical losses in a high pressure displacement pump used in a hydrostatic drive. Part II Mechanical losses in a pump* // Polish Maritime Research, Vol.19 3/2012
5. Paszota Z.: *Theoretical and mathematical models of the torque of mechanical losses in the pump used in a hydrostatic drive.* (in Polish). Chapter in the monograph: „Research, design, production and operation of hydraulic systems” (in Polish) Adam Klich, Antoni Kozieł and Edward Palczak editors. „Cylinder” Library. „Komag” Mining Mechanisation Centre, Gliwice 2011
6. Paszota Z.: *Theoretical and mathematical models of the torque of mechanical losses in the pump used in a hydrostatic drive.* (in Polish). „Napędy i sterowanie”, scientific monthly 10/2011
7. Paszota Z.: *Theoretical and mathematical models of the torque of mechanical losses in the pump used in a hydrostatic drive.* Polish Maritime Research, Vol. 18, 4/2011
8. Koralewski J.: *Effect of the liquid viscosity on the energy characteristics of variable capacity piston pump* (in Polish). Doctor dissertation (continued). Gdańsk University of Technology, Faculty of Ocean Engineering and Ship Technology
9. Koralewski J.: *Effect of oil viscosity and compressibility on determination of volumetric losses in a variable capacity piston pump* (In Polish). Paper submitted to the „Cylinder” 2013 Conference. Centrum Mechanizacji Górnictwa „Komag”, Gliwice 2013
10. Guillon M.: *Theory and calculation of hydraulic systems* (in Polish). Wydawnictwa Naukowo-Techniczne Warszawa 1967

CONTACT WITH THE AUTHOR

Prof. Zygmunt Paszota
Faculty of Ocean Engineering
and Ship Technology
Gdansk University of Technology
Narutowicza 11/12
80-233 Gdansk, POLAND
e-mail: zpaszota@pg.gda.pl