

VARIABLE-STRUCTURE REPETITIVE CONTROL FOR DISCRETE-TIME LINEAR SYSTEMS WITH MULTIPLE-PERIOD EXOGENOUS SIGNALS

EDI KURNIAWAN^{a,*}, HENDRA G. HARNO^b, SENSUS WIJONARKO^a,
BAMBANG WIDIYATMOKO^a, DWI BAYUWATI^a,
PURWOWIBOWO PURWOWIBOWO^a,
TATIK MAFTUKHAH^a

^a Research Center for Physics
Indonesian Institute of Sciences
Kawasan PUSPIPTK Serpong, Tangerang Selatan, 15314, Indonesia
e-mail: edi.kurniawan@lipi.go.id

^b Department of Aerospace and Software Engineering
Gyeongsang National University
501 Jinju-daero, Jinju-si 52828, Gyeongsangnam-do, Republic of Korea
e-mail: h.g.harno@gmail.com

A new method to construct a discrete-time variable-structure repetitive controller for a class of linear systems perturbed by multiple-period exogenous signals is presented. The proposed control scheme combines the features of the discrete-time multiple-period repetitive control (MP-RC) and variable-structure control (VSC) techniques. The MP-RC part is assigned to simultaneously track and reject periodic signals consisting of multiple uncorrelated fundamental frequencies. The VSC part is then integrated to provide a fast transient response and robustness against plant parameter variations. Stability and robustness analyses are also elaborated to ensure that the resulting closed-loop system satisfies the desired control objectives. Moreover, it is shown through an example that the repetitive control system constructed using the proposed control method can effectively track a sinusoidal reference signal despite the presence of a multiple-period disturbance.

Keywords: repetitive control, variable-structure control, multiple-period signals, fast transient response, robustness.

1. Introduction

An underlying idea of the repetitive control (RC) approach originates from the internal model principle proposed by Francis and Wonham (1975) to enable a feedback control system to accurately track periodic reference signals and to reject periodic disturbance signals simultaneously. By applying the internal model principle, one is able to incorporate a model of reference and/or disturbance signals into the control system. The RC method has successfully been implemented to cope with such periodic signals found in various applications, e.g., hard-disk-drive systems (Chen and Tomizuka, 2014), piezo-actuated nano-positioning systems (Li *et al.*, 2017), robotic arm manipulators (Muramatsu and Katsura, 2018), and power electronic systems (Lorenzini *et al.*, 2018).

This shows that the RC method is applicable for different classes of single-input single-output (SISO) and multi-input multi-output (MIMO) linear and nonlinear systems (Flores *et al.*, 2012; Kurniawan *et al.*, 2014; 2016a; Tomei and Verrelli, 2015; Zhou *et al.*, 2016; Sun *et al.*, 2018; Sakthivel *et al.*, 2020).

There are two particular tasks performed by a repetitive controller, that is, to learn from error and control signals of the previous cycle and then to generate a compensating signal for the next cycle. Having such a learning capability, the repetitive controller is thus more likely to outperform typical non-predictive controllers, such as PI and PID ones, in terms of tracking performance (Hillerstrom and Walgama, 1996). The learning mechanism of the RC technique, however, gives rise to a one-cycle delay until the repetitive controller produces the compensating signal. Such a

*Corresponding author

delay induces a prolonged transient period which renders the repetitive controller inappropriate for dealing with non-periodic signals. When a sudden change occurs, the repetitive controller also exhibits a slow response (Chen *et al.*, 2009). Moreover, unmodeled system dynamics, nonlinearities, and unknown perturbations may also degrade the performance of the repetitive controller.

Thus, to rectify shortcomings of the RC method, one may complement it with other control techniques such as H_∞ control, observer-based linear-quadratic control, and variable-structure control (VSC). Various combinations of the RC method with any of these control techniques are realized to handle tracking control problems under different circumstances. The RC method based on the H_∞ control approach can be applied to attenuate (periodic) disturbance signals as much as possible while tracking periodic reference signals (Hornik and Zhong, 2011; Wang *et al.*, 2018). An alternative approach to enhance the performance of an RC system in rejecting disturbance effects upon the system output is to complement the repetitive controller with a disturbance observer designed based on the linear-quadratic control method (Zhou *et al.*, 2019; 2020). When a fast transient response and robustness against uncertainties are desirable, the repetitive controller can also be combined with the VSC technique (Mingxuan *et al.*, 2005; Lu *et al.*, 2012; Mitrevska *et al.*, 2018), which allows fast switching between two different structures. Taking account of a great extent of the aforementioned combinations, we confine our subsequent discussion to the combination of the RC and VSC methods, which constitutes the main contribution of this paper.

In this respect, we would like to present a novel discrete-time approach to constructing the repetitive control law in combination with the VSC method. Our interest in this approach is motivated by the fact that digital controllers are pervasively used in nowadays' control systems. Also, we are particularly concerned with constructing a repetitive control system that is capable of tracking multiple-period reference signals under the influence of periodic disturbance signals with multiple uncorrelated fundamental periods/frequencies. Such a control problem is usually found in power electronic and electro-mechanical (with multiple rotating machineries) systems (Owens *et al.*, 2004; Pérez-Arancibia *et al.*, 2010; Rashed *et al.*, 2013). Hence, in this paper, we intend to address this control problem in the discrete-time domain by proposing a multiple-period variable-structure repetitive control (MP-VSRC) method, which is complementary to those of Owens *et al.* (2004), Pérez-Arancibia *et al.* (2010), and Rashed *et al.* (2013). Our approach is thus not only an enhancement of that presented by Kurniawan *et al.* (2017), but also has not been considered by Mingxuan *et al.* (2005), Lu *et al.* (2012), and Mitrevska *et al.* (2018).

Moreover, the MP-VSRC method we propose involves satisfying a reaching law in order to guarantee close-loop stability and robustness. The reaching law is imposed because a discrete-time variable-structure controller cannot directly be obtained from its continuous-time counterpart by a simple equivalence. Consequently, without imposing such a reaching law, constructing the discrete-time variable-structure controller by applying a finite sampling frequency can only yield one with a limited switching frequency and compromised robustness and invariance properties. This issue has been discussed by, for example, Gao *et al.* (1995), Bartoszewicz and Lesniewski (2016), Ma *et al.* (2019), and Zhang *et al.* (2019).

Synthesizing a discrete-time repetitive controller with the RC method we propose, one is able to establish a closed-loop system endowed with (a) robust stability against parametric variations, (b) fast transient responses, (c) accurate tracking multiple-period reference signals, and (d) good rejection of multiple-period disturbance signals. These features are demonstrated via an example of controlling a servomotor, which is assigned to track a sinusoidal signal, with a repetitive controller designed using the proposed RC method. Simulation results presented in this example show that the resulting controller outperforms the variable-structure repetitive one designed based on the minimum-variance control approach proposed by Mingxuan *et al.* (2005) and the ordinary multiple-period repetitive control system proposed by Kurniawan *et al.* (2017) when they are applied to the servomotor considered.

The rest of this paper is organized as follows. Section 2 describes the control problem in question, underlying assumptions, and fundamental notions of discrete-time RC and VSC. Sections 3 and 4 present the proposed control method, and stability and robustness analyses, respectively. Simulation results and discussions are presented in Section 5. Lastly, concluding remarks are given in Section 6.

2. Problem formulation and preliminaries

2.1. Repetitive control problem. Let us consider a discrete-time linear time-invariant (LTI) system described as follows:

$$y(z) = z^{-d} \frac{B(z)}{A(z)} u(z) + w(z), \quad (1)$$

where $y(z)$, $u(z)$, and $w(z)$ are the \mathcal{Z} -transforms of discrete-time signals $y(k)$, $u(k)$, and $w(k)$, respectively. Here, $y(k) \in \mathbb{R}$ is the system output, $u(k) \in \mathbb{R}$ is the control input, $w(k) \in \mathbb{R}$ is the exogenous disturbance on the output $y(k)$, $d \in \mathbb{N}$ is a known delay step, and $B(z)$ and $A(z)$ are respectively the numerator and denominator of the system transfer function.

The numerator $B(z)$ and denominator $A(z)$ are polynomials in $z \in \mathbb{C}$ written as follows:

$$B(z) = b_0 + b_1 z^{-1} + b_2 z^{-2} + \dots + b_m z^{-m}, \quad (2)$$

$$A(z) = 1 + a_1 z^{-1} + a_2 z^{-2} + \dots + a_n z^{-n}, \quad (3)$$

where $m, n \in \mathbb{N}$, $m < n$. The system (1) is required to track a reference signal $r(k)$ such that the difference between $r(k)$ and $y(k)$ gives rise to a tracking error defined as

$$e(k) := r(k) - y(k). \quad (4)$$

To simultaneously address the problem of tracking and rejection of the periodic reference and disturbance signals, which have multiple uncorrelated fundamental frequencies, several assumptions are presented as follows.

Assumption 1. The reference signal $r(k)$ is a periodic signal that may consist of multiple uncorrelated periods $T_r = \{T_{r1}, T_{r2}, \dots, T_{rh}\}$. Each element in T_r is known and $T_{r1} \neq T_{r2} \neq \dots \neq T_{rh}$.

Assumption 2. The disturbance $w(k)$ is also a periodic signal composed of multiple uncorrelated periods $T_w = \{T_{w1}, T_{w2}, \dots, T_{wj}\}$. Each element in T_w is known and $T_{w1} \neq T_{w2} \neq \dots \neq T_{wj}$.

Assumption 3. The system model (1) is known and stable, and has a minimum phase. The polynomials $B(z)$ and $A(z)$ in (2) and (3) are relatively prime. The system output $y(k)$ is measurable.

The control objectives are to cancel the effect of the multiple-period disturbance $w(k)$ and to track the periodic reference $r(k)$ such that the tracking error $e(k)$ converges to a small value, and the resulting closed-loop system has a fast transient response and is robust against the parametric variations.

2.2. Discrete-time RC. Suppose an open-loop system (1) is subject to a periodic reference $r(k)$ and a disturbance $w(k)$. Both signals have a single fundamental period: T_r and T_w , respectively. The RC method can be used to construct a repetitive controller to form a stable closed-loop system that is enabled to track the periodic reference signal and to reject the periodic disturbance one. Thus, the resulting control law is of the form

$$u(k) = u(k - N_0) + \mathcal{Z}^{-1} [L(z)z^{-N_0}e(z)], \quad (5)$$

where $\mathcal{Z}^{-1}[\cdot]$ is the inverse \mathcal{Z} -transform operator, $N_0 = T_r/T$ is the length of an RC integer delay or the number of samples per period T_r , T is the sampling period, and $L(z)$ is a learning function.

Both periodic reference tracking and disturbance rejection can be simultaneously achieved as long as the

reference period T_r is equal to the disturbance period T_w , or these two periods satisfy

$$T_w = \frac{T_r}{a}, \quad a = 1, 2, \dots, N_0/2. \quad (6)$$

This implies that the disturbance frequency f_w has to be the harmonics of the reference frequency f_r .

To ensure asymptotic convergence of the tracking error $e(k)$, two stability conditions required to be satisfied are as follows (Grino and Costa-Castello, 2005; Longman, 2010):

1. The polynomial $A(z)$ has stable zeros.
2. The learning function $L(z)$ is such that the H_∞ norm

$$\left\| 1 - L(z)z^{-d} \frac{B(z)}{A(z)} \right\|_\infty < 1. \quad (7)$$

If the system (1) is stable and has a minimum phase, the learning function $L(z)$ can then be chosen as the inverse of the system (1). Such a learning function will lead to error convergence after one learning cycle. Thus, in general, the discrete-time RC method involves computing the length N_0 of the RC integer delay based on the known reference/disturbance period, and determining the learning function $L(z)$ based on the known system model.

2.3. Discrete-time VSC. The VSC method is known as a nonlinear control method that employs a sliding function to provide robustness against model uncertainties and a fast transient response. For an output-based system, where the system output is the only signal available for feedback control, the discrete-time VSC method generally proceeds as follows:

1. Determine the sliding function $s(k)$ such that the sliding mode in the switching plane $s(k) = 0$ is stable.
2. Determine the reaching law $[s(k) - s(k - d)]$ that directly dictates the dynamics of the sliding function $s(k)$.
3. Synthesize a variable-structure control law based on the reaching law in conjunction with the known system model.

Thus, for the system model (1), a linear sliding function $s(k)$ is defined as

$$s(k) := \mathcal{Z}^{-1} [C(z)e(z)], \quad (8)$$

where $C(z)$ is a designed polynomial with stable zeros. The discrete-time reaching law (Gao *et al.*, 1995; Mingxuan *et al.*, 2005) is then given as

$$s(k) - s(k - d) = -qTs(k - d) - \epsilon Ts_f(k - d), \quad (9)$$

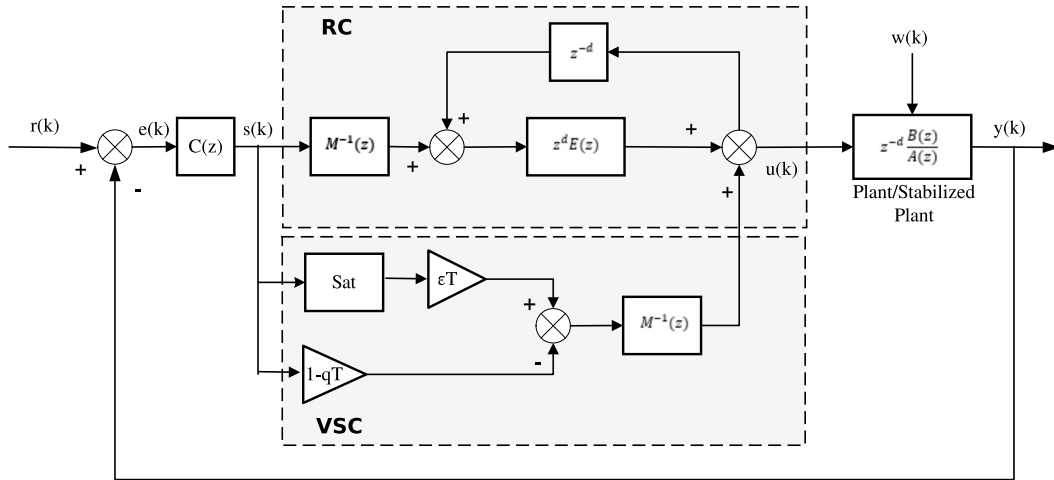

Fig. 1. Block diagram of the proposed MP-VSRC system.

where $q > 0$, $\epsilon > 0$, and $T > 0$ is the sampling period. The term $s_f(k - d)$ in (9) is a delayed smoothing function defined as a saturation function. That is,

$$s_f(k - d) := \text{sat} \left(\frac{s(k - d)}{\delta} \right) = \begin{cases} 1, & s(k - d) > \delta, \\ \frac{s(k - d)}{\delta}, & -\delta \leq s(k - d) \leq \delta, \\ -1, & s(k - d) < -\delta. \end{cases} \quad (10)$$

Here, $\delta > 0$ is an arbitrarily small constant.

It thus follows that one can synthesize a variable-structure controller for the system (1) based on the sliding function (8) and the reaching law (9) (Kurniawan et al., 2016b). That is,

$$u(k) = u(k - d) + \mathcal{Z}^{-1} \left[\frac{A(z)}{B(z)} (1 - z^{-d}) r(z) \right] + \mathcal{Z}^{-1} [F(z)G^{-1}(z) \{1 - z^{-d}\} e(z)] + \mathcal{Z}^{-1} [G^{-1}(z) \{qTs(z) + \epsilon Ts_f(z)\}]. \quad (11)$$

Note that $G(z) := E(z)B(z)$ and $F(z)$ and $E(z)$ are polynomials satisfying $C(z) = z^{-d}F(z) + A(z)E(z)$. The synthesized controller (11) is required to ensure that the sliding function $s(k)$ converges to a sliding surface by satisfying the reaching condition (Gao et al., 1995) as follows:

$$|s(k)| < |s(k - d)|. \quad (12)$$

3. Multiple-period variable-structure repetitive control

In this section, we present a new control strategy referred to as the multiple-period variable-structure repetitive control (MP-VSRC) method to deal with the control problem stated in Section 2. A block diagram is shown

in Fig. 1 to illustrate the MP-VSRC system proposed. The MP-VSRC method is a complementary combination of the discrete-time VSC and RC methods with multiple internal models. However, a meaningful combination is not obtained by simply adding a repetitive controller to a variable-structure one as it does not guarantee the stability of the resulting closed-loop system and the asymptotic convergence of the tracking error. Hence, the desirable controller based on the proposed MP-VSRC method is derived as follows.

First, an error dynamic corresponding to the system (1) is obtained by substituting (1) into (4) such that

$$e(k) = r(k) - \mathcal{Z}^{-1} \left[z^{-d} \frac{B(z)}{A(z)} u(z) \right] - w(k). \quad (13)$$

Suppose that the reference $r(k)$ and the disturbance $w(k)$ make up $(h + j)$ periods altogether, where h and j denote the number of the fundamental periods of each signal, respectively. Let

$$v(k) := r(k) - w(k), \quad (14)$$

and $N_i \in \mathbb{N}$ be the number of samples per period T_i defined as

$$N_i := \frac{T_i}{T}, \quad i = 1, 2, \dots, h + j. \quad (15)$$

We also define $I_M(z)$ as

$$I_M(z) := \prod_{i=1}^{h+j} (1 - z^{-N_i}), \quad (16)$$

such that for the repetitive signals $r(k)$, $w(k)$, and $v(k)$, the following properties hold:

$$P1 : \mathcal{Z}^{-1} [I_M(z)r(z)] = 0, \quad (17)$$

$$P2 : \mathcal{Z}^{-1} [I_M(z)w(z)] = 0, \quad (18)$$

$$P3 : \mathcal{Z}^{-1} [I_M(z)v(z)] = 0. \quad (19)$$

Now, let $I_M(z)$ in (16) be rewritten as

$$I_M(z) = 1 - \sum_{p=N_l}^{N_T} c_p z^{-p} \quad (20)$$

where $N_l = \min \{N_1, N_2, \dots, N_{h+j}\}$, $N_T = \sum_{i=1}^{h+j} N_i$, and $c_p \in \{-1, 0, 1\}$, and $E(z)$ be defined as

$$E(z) := \sum_{p=N_l}^{N_T} c_p z^{-p}. \quad (21)$$

Then, $P3$ in (19) can be expressed as

$$v(k) - \mathcal{Z}^{-1} [E(z)v(z)] = 0. \quad (22)$$

Furthermore, write

$$\hat{v}(k) = \mathcal{Z}^{-1} [E(z)v(z)], \quad (23)$$

and regard it as delayed $v(k)$. Multiplying both the sides of the sliding function $s(k)$ in (8) by $I_M(z)$, we obtain

$$I_M(z)s(z) = I_M(z)C(z)e(z). \quad (24)$$

Substituting (13) into (24) leads to

$$I_M(z)s(z) = I_M(z)C(z) \left\{ r(z) - z^{-d} \frac{B(z)}{A(z)} u(z) - w(z) \right\}. \quad (25)$$

Let

$$M(z) = C(z) \frac{B(z)}{A(z)}. \quad (26)$$

Applying (20) and (26) to (25), we have

$$s(z) - E(z)s(z) = -M(z) \left\{ z^{-d} u(z) - E(z)z^{-d} u(z) \right\}. \quad (27)$$

Substituting the reaching law (9) into (27), we obtain the delayed control law

$$u(k-d) = \mathcal{Z}^{-1} [E(z)z^{-d}u(z)] + \mathcal{Z}^{-1} \left[\frac{E(z)}{M(z)} s(z) \right] - \mathcal{Z}^{-1} \left[M^{-1}(z) \left\{ (1-qT)z^{-d}s(z) - \epsilon T z^{-d} s_f(z) \right\} \right]. \quad (28)$$

The control law $u(k)$ is therefore obtained by shifting forward d steps the delayed control law $u(k-d)$ given in (28). That is,

$$u(k) = \mathcal{Z}^{-1} [E(z)u(z)] + \mathcal{Z}^{-1} \left[\frac{z^d E(z)}{M(z)} s(z) \right] - \mathcal{Z}^{-1} \left[M^{-1}(z) \left\{ (1-qT)s(z) - \epsilon T s_f(z) \right\} \right]. \quad (29)$$

Remark 1. From (29), we notice the terms $E(z)$, z^d , $M^{-1}(z)$ involved in the construction of the control law $u(k)$. The term $E(z)$ basically indicates multiple delays with different lengths arranged in parallel. The non-causal term z^d is applicable due to $d < N_l$, where N_l is given in (20).

Remark 2. Since (a) the LTI system (1) is minimum phase, (b) the polynomials $A(z)$ and $B(z)$ are co-prime, and (c) $C(z)$ is a stable polynomial, the transfer function $M^{-1}(z)$ is both stable and realizable. We then refer to the transfer function $M^{-1}(z)$ as the MP-VSRC learning function.

Considering Remarks 1 and 2, we claim that the control law $u(k)$ in (29) is a bounded control signal that enables the resulting closed-loop system to track and reject the multiple-period signals, and that ensures asymptotic convergence of the sliding function $s(k)$. This claim will be proved through a stability analysis presented in Section 4.

4. Stability and robustness

4.1. Stability analysis. To prove the claim made about the control law $u(k)$ in (29), it is necessary to show that the reaching condition (12) is satisfied. Thus, (12) is first written in an equivalent form as follows:

$$[s(k) - s(k-d)] \operatorname{sgn}(s(k-d)) < 0, \quad (30)$$

$$[s(k) + s(k-d)] \operatorname{sgn}(s(k-d)) > 0. \quad (31)$$

Now, we derive a quasi-sliding dynamic in terms of the control law $u(k)$ in (29) by substituting the error dynamic (13) into the sliding function (8). That is,

$$s(k) = \mathcal{Z}^{-1} [C(z)r(z)] - \mathcal{Z}^{-1} \left[C(z) \frac{B(z)}{A(z)} z^{-d} u(z) \right] - \mathcal{Z}^{-1} [C(z)w(z)]. \quad (32)$$

Applying the delayed control law $u(k-d)$ in (28) to the quasi-sliding dynamic (32), we obtain

$$s(k) = (1-qT)s(k-d) - \epsilon T s_f(k-d) + \mathcal{Z}^{-1} [C(z) \{1 - E(z)\} \{r(z) - w(z)\}]. \quad (33)$$

Further modification of the quasi-sliding dynamic (33) by using (23) results in

$$s(k) = (1-qT)s(k-d) - \epsilon T s_f(k-d) + \mathcal{Z}^{-1} [C(z) \{v(z) - \hat{v}(z)\}]. \quad (34)$$

The expression of the quasi-sliding dynamic in (34) can be interpreted as composed of a repetitive error $\epsilon_r(k)$ and a sliding error $\epsilon_s(k)$. That is,

$$\epsilon_r(k) = \mathcal{Z}^{-1} [C(z) \{v(z) - \hat{v}(z)\}], \quad (35)$$

$$\epsilon_s(k) = (1-qT)s(k-d) - \epsilon T s_f(k-d). \quad (36)$$

Remark 3. The repetitive error $\epsilon_r(k)$ in (35) is a periodic signal because $v(k)$ defined in (14) is periodic due to the periodicity of the reference $r(k)$ and the disturbance $w(k)$. Similarly, $\hat{v}(k)$ is also periodic as it is a delayed $v(k)$ by one cycle, which is equivalent to the sum of the periods of both $r(k)$ and $w(k)$. This implies that $(v(k) - \hat{v}(k))$ is zero for $k \geq N_T + 1$, and so is $\epsilon_r(k)$. Otherwise, $(v(k) - \hat{v}(k))$ has a bounded non-zero value during the learning cycle for $k < N_T + 1$ and so does $\epsilon_r(k)$ since the polynomial $C(z)$ is stable.

Theorem 1. Suppose that $|\epsilon_r(k)| < \gamma$ and $\gamma > 0$, and the parameters $q > 0$, $T > 0$, $\epsilon > 0$, and $\delta > 0$ are chosen such that

$$(1 - qT) > 0, \quad \delta(1 - qT) > \epsilon T, \quad \epsilon T > \gamma. \quad (37)$$

Then, for any sliding function $s(k - d) > \delta$, the quasi-sliding dynamic (34) satisfies

$$s(k) - s(k - d) < 0, \quad (38)$$

$$s(k) + s(k - d) > 0. \quad (39)$$

Proof. Subtract $s(k - d)$ from both sides of (34). Then

$$\begin{aligned} s(k) - s(k - d) &= \epsilon_r(k) - qTs(k - d) \\ &\quad - \epsilon Ts_f(k - d). \end{aligned} \quad (40)$$

Moreover, since $0 < \delta < s(k - d)$, we have $s_f(k - d) = \text{sat}(s(k - d)/\delta) = 1$ and (38) holds. That is,

$$\begin{aligned} s(k) - s(k - d) &= -qTs(k - d) - \epsilon T + \epsilon_r(k) \\ &< -qTs(k - d) - \epsilon T + \gamma \\ &< -\epsilon T + \gamma \\ &< 0. \end{aligned} \quad (41)$$

Now, add $s(k - d)$ to both the sides of (34). Then

$$\begin{aligned} s(k) + s(k - d) &= \epsilon_r(k) + (2 - qT)s(k - d) \\ &\quad - \epsilon Ts_f(k - d). \end{aligned} \quad (42)$$

Since $0 < \delta < s(k - d)$ and $\delta(1 - qT) > \epsilon T$, which is equivalent to $-\epsilon T > \delta(qT - 1)$, (39) holds. That is,

$$\begin{aligned} s(k) + s(k - d) &= (2 - qT)s(k - d) - \epsilon T + \epsilon_r(k) \\ &> (2 - qT)\delta - \epsilon T + \epsilon_r(k) \\ &= \delta + (1 - qT)\delta - \epsilon T + \epsilon_r(k) \\ &> \delta + (1 - qT)\delta + (qT - 1)\delta + \epsilon_r(k) \\ &= \delta + \epsilon_r(k) \\ &> \epsilon T + \epsilon_r(k) \\ &> \gamma + \epsilon_r(k) \\ &> 0. \end{aligned} \quad (43)$$

This completes the proof. \blacksquare

Theorem 2. Suppose that $|\epsilon_r(k)| < \gamma$ and $\gamma > 0$, and the parameters $q > 0$, $T > 0$, $\epsilon > 0$, and $\delta > 0$ are chosen such that (37) is satisfied. Then, for any sliding function $s(k - d) < -\delta$, the quasi-sliding dynamic (34) satisfies

$$s(k) - s(k - d) > 0, \quad (44)$$

$$s(k) + s(k - d) < 0. \quad (45)$$

Proof. From $s(k - d) < -\delta < 0$, it follows that $s_f(k - d) = -1$, and based on (40), (44) holds. That is,

$$\begin{aligned} s(k) - s(k - d) &= -qTs(k - d) + \epsilon T + \epsilon_r(k) \\ &> qT\delta + \epsilon T + \epsilon_r(k) \\ &> qT\delta + \gamma + \epsilon_r(k) \\ &> qT\delta \\ &> 0. \end{aligned} \quad (46)$$

Now, based on (42), (45) also holds. That is,

$$\begin{aligned} s(k) + s(k - d) &= (2 - qT)s(k - d) + \epsilon T + \epsilon_r(k) \\ &< -(2 - qT)\delta + \epsilon T + \epsilon_r(k) \\ &= -\delta - (1 - qT)\delta + \epsilon T + \epsilon_r(k) \\ &< -\delta - (1 - qT)\delta + (1 - qT)\delta + \epsilon_r(k) \\ &< -\delta + \gamma \\ &< 0. \end{aligned} \quad (47)$$

This completes the proof. \blacksquare

By the proofs of Theorems 1 and 2, we have shown that the reaching conditions (30) and (31) hold. This implies that the control law $u(k)$ in (29) indeed guarantees the convergence of the sliding function $s(k)$ and the tracking error $e(k)$ to zero.

4.2. Robustness analysis. Multiply both the sides of (1) by $A(z)$ to get

$$A(z)y(z) = z^{-d}B(z)u(z) + A(z)w(z). \quad (48)$$

Suppose that the LTI system in (48) is perturbed by parametric uncertainties such that

$$\begin{aligned} \{A(z) + \Delta_A(z)\}y(z) &= z^{-d}\{B(z) + \Delta_B(z)\}u(z) \\ &\quad + \{A(z) + \Delta_A(z)\}w(z), \end{aligned} \quad (49)$$

which can be recast as

$$\begin{aligned} y(z) &= z^{-d}\frac{B(z)}{A(z)}u(z) + w(z) + z^{-d}\frac{\Delta_B(z)}{A(z)}u(z) \\ &\quad - \frac{\Delta_A(z)}{A(z)}y(z) + \frac{\Delta_A(z)}{A(z)}w(z). \end{aligned} \quad (50)$$

Also, define

$$w_T(k) := w(k) + w_\Delta(k), \quad (51)$$

where

$$\begin{aligned} w_{\Delta}(k) = & \mathcal{Z}^{-1} \left[z^{-d} \frac{\Delta_B(z)}{B(z)} u(z) \right] \\ & - \mathcal{Z}^{-1} \left[\frac{\Delta_A(z)}{A(z)} y(z) \right] \\ & + \mathcal{Z}^{-1} \left[\frac{\Delta_A(z)}{A(z)} w(z) \right]. \end{aligned} \quad (52)$$

Thus, $w_T(k)$ can be considered a total perturbation upon the system (1) that consists of the periodic disturbance $w(k)$ and the perturbation $w_{\Delta}(k)$ caused by the parametric uncertainties. Also, applying the control law $u(k)$ in (29) to the uncertain system (49), one can rewrite the sliding dynamic $s(k)$ (34) as

$$\begin{aligned} s(k) = & (1 - qT)s(k - d) - \epsilon T s_f(k - d) \\ & + \mathcal{Z}^{-1} [C(z) \{v(z) - \hat{v}(z)\}] \\ & + \mathcal{Z}^{-1} [C(z) \{1 - E(z)\} w_{\Delta}(z)]. \end{aligned} \quad (53)$$

Now, the sliding dynamic $s(k)$ consists of three error terms: the sliding error $\epsilon_s(k)$, the repetitive error $\epsilon_r(k)$, and the parametric error $\epsilon_{\Delta}(k)$. That is,

$$s(k) = \epsilon_s(k) + \epsilon_r(k) + \epsilon_{\Delta}(k). \quad (54)$$

In this case, $\epsilon_r(k)$ and $\epsilon_s(k)$ are given in (35) and (36), respectively, whereas $\epsilon_{\Delta}(k)$ is expressed as

$$\epsilon_{\Delta}(k) = \mathcal{Z}^{-1} [C(z) \{1 - E(z)\} w_{\Delta}(z)]. \quad (55)$$

Despite the presence of $\epsilon_{\Delta}(k)$ in (54), the properties (38), (39), (44), and (45) representing the reaching conditions (30) and (31) remain valid. In this regard, the assumption $|\epsilon_r(k)| < \gamma$ in Theorems 1 and 2 is replaced by $|\epsilon_r(k) + \epsilon_{\Delta}(k)| < \beta$, where $\beta > \gamma > 0$. Also, the parameters $q > 0$, $T > 0$, $\epsilon > 0$, and $\delta > 0$ are chosen such that

$$(1 - qT) > 0, \quad \delta(1 - qT) > \epsilon T, \quad \epsilon T > \beta. \quad (56)$$

Hence, to prove the satisfaction of the properties (38), (39), (44), and (45), one can analogously follow the same steps as those presented in Section 4.1, where the same reaching conditions are satisfied for the cases without the parametric error $\epsilon_{\Delta}(k)$ term.

The controller design procedure according to the MP-VSRC method is then summarized in Algorithm 1. Note that, for a given plant, the positive constants q , ϵ , and δ are chosen not only to satisfy (37) or (56), but also to facilitate a fast transient response without giving rise to chattering. Hence, one needs to iteratively determine the values of those parameters in order to obtain a stabilizing MP-VSRC controller with satisfactory performance.

Algorithm 1. MP-VSRC algorithm.

Step 1. Obtain the polynomials $A(z)$, $B(z)$, and the delay d from the system model (1).

Step 2. Obtain the periods T_r and T_w , then calculate the number N_i of samples per period as given in (15).

Step 3. Determine the stable polynomial $C(z)$, and choose the positive constants q , ϵ , δ to satisfy (37).

Step 4. Compute the polynomial $E(z)$ in (21).

Step 5. Compute the learning function $M^{-1}(z)$ in (26).

Step 6. Construct the control law $u(k)$ as in (29).

5. Numerical example

In this section, we present an example of synthesizing a variable-structure repetitive controller using the control method presented in Section 3 for a linear system given as follows:

$$y(k) = \mathcal{Z}^{-1} [H(z)] u(k) + w(k), \quad (57)$$

where

$$H(z) = z^{-1} \frac{0.0763 + 0.0717z^{-1}}{1 - 1.753z^{-1} + 0.9015z^{-2}}. \quad (58)$$

The transfer function $H(z)$ in (58) is stable and minimum phase, and it is a discrete-time model of a Quanser servomotor whose continuous-time dynamic is sampled with the sampling period $T = 0.005$ s (Kurniawan *et al.*, 2014). In this case, $H(z)$ was determined by first stabilizing the servomotor with a proportional gain $K = 100$ in order to be able to apply the MP-VSRC method. However, in general, one may opt to employ other types of controllers to pre-stabilize a plant whenever appropriate.

5.1. Controller design. From (58), we obtain the time-delay step d , and the polynomials $A(z)$ and $B(z)$ as follows: $d = 1$, $A(z) = 1 - 1.753z^{-1} + 0.9015z^{-2}$, and $B(z) = 0.0763 + 0.0717z^{-1}$. In this example, we assume that the servomotor (57), (58) is required to track a sinusoidal reference signal $r(k)$ with a single period of

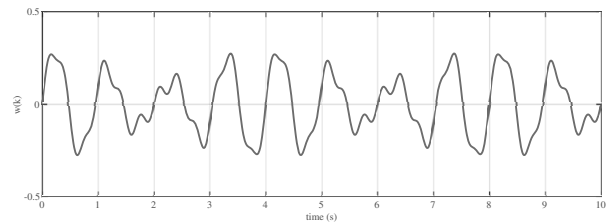
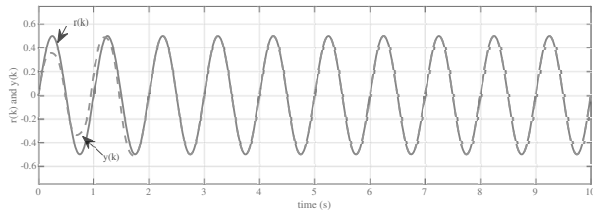
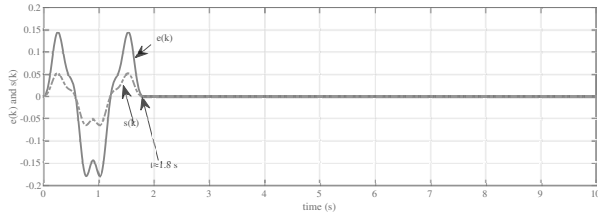

Fig. 2. Exogenous disturbance $w(k)$ with multiple periods.



(a)



(b)

Fig. 3. Tracking performance of the control law $u(k)$ in (63): the reference $r(k)$ and the tracking output $y(k)$ (a), the tracking error $e(k)$ and the sliding function $s(k)$ (b).

1 s and an amplitude 0.5, and to eliminate the effect of the multiple-period disturbance signal $w(k)$ given by

$$w(k) = 0.1 \sin(2\pi k/0.8) + 0.2 \sin(2\pi k) + 0.05 \sin(6\pi k), \quad (59)$$

as illustrated in Fig. 2. Thus, the fundamental periods of both $r(k)$ and $w(k)$ are $T_1 = 0.8$ s and $T_2 = 1$ s, which result in $N_1 = 160$ and $N_2 = 200$, respectively.

In order for the tracking error $e(k)$ to be significantly attenuated, $C(z)$ is required to be stable and set to be

$$C(z) = 1 - 0.8z^{-1} + 0.16z^{-2}. \quad (60)$$

Moreover, the parameters q , ϵ , and δ are chosen to be 198, 16, and 0.1, respectively. Then, the polynomial $E(z)$ and the transfer function $M^{-1}(z)$ are respectively determined as

$$E(z) = z^{-160} + z^{-200} - z^{-360}, \quad (61)$$

$$M^{-1}(z) = \frac{13.106(1 - 1.753z^{-1} + 0.9015z^{-2})}{1 + 0.139z^{-1} - 0.592z^{-2} + 0.150z^{-3}}. \quad (62)$$

The desirable controller is therefore

$$u(k) = \mathcal{Z}^{-1} [E(z)u(z)] + \mathcal{Z}^{-1} \left[\frac{zE(z)}{M(z)} s(z) \right] - \mathcal{Z}^{-1} \left[M^{-1}(z) \{ 0.01s(z) - 0.08s_f(z) \} \right]. \quad (63)$$

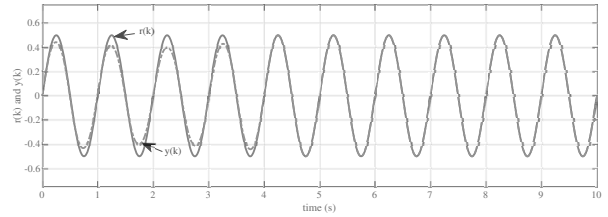

(a)

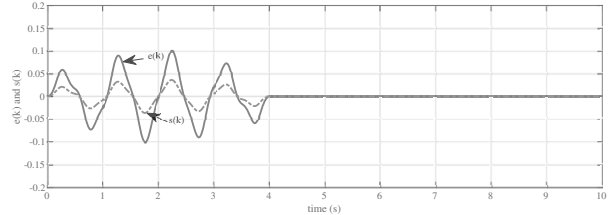

(b)

Fig. 4. Tracking performance with the control law $u(k)$ in (64): the reference $r(k)$ and the tracking output $y(k)$ (a), the tracking error $e(k)$ and the sliding function $s(k)$ (b).

5.2. Simulation results. The performance of the resulting closed-loop system in tracking $r(k)$ and rejecting $w(k)$ is shown in Fig. 3. It is noticeable in Fig. 3(a) that there is a discrepancy between the tracking output $y(k)$ and the reference $r(k)$ during the transient period. This is reasonable because the transient period is a learning cycle for the RC part, while the VSC part alone handles both the tracking and rejection tasks. Here, the learning function $M^{-1}(z)$ perfectly compensates the system dynamics, which allows one-cycle convergence. This is clearly shown in Fig. 3(b), where the tracking error $e(k)$ and the sliding function $s(k)$ converge to zero after one cycle. In this case, one cycle is defined as the total period $T_1 + T_2$, which is equal to 1.8 s.

The merit of the MP-VSRC method is shown further through comparison in terms of the transient response and robustness against parametric uncertainties. First, the transient performance of the controller $u(k)$ in (63) was compared with that of the repetitive controller synthesized using the minimum-variance VSRC method (Mingxuan et al., 2005), which yields

$$u(k) = u(k - N_0) - \mathcal{Z}^{-1} \left[\frac{F(z)}{G(z)} (1 - z^{-N_0}) e(z) \right] - \mathcal{Z}^{-1} \left[G^{-1}(z) \{ -0.01s(z) + 0.08s_f(z) \} \right] - \mathcal{Z}^{-1} \left[G^{-1}(z) z^{-N_0+d} s(z) \right], \quad (64)$$

where $F(z)$ and $G(z)$ in (64) are polynomials given by $F(z) = 0.953 - 0.7415z^{-1}$ and $G(z) = 0.076 + 0.072z^{-1}$.

The controller $u(k)$ in (64) has a single delay N_0 and requires three input signals. The delay period T_0 of

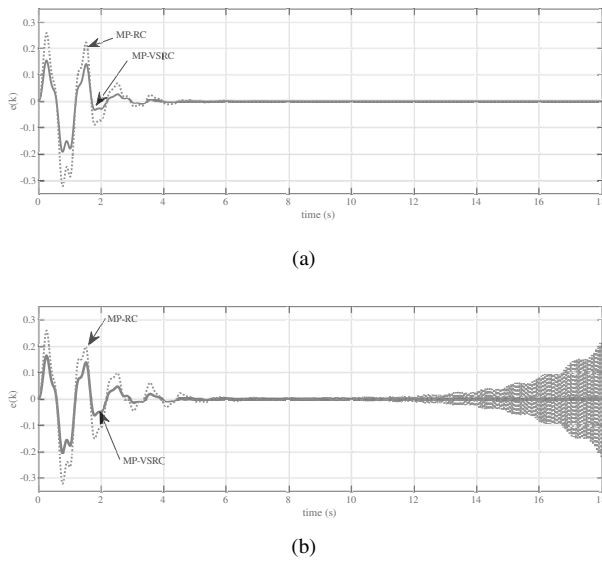

Fig. 5. Tracking errors $e(k)$: Case 1 (a), Case 2 (b).

this controller is 4 s, which serves as the basis period of T_1 and T_2 and yields $N_0 = 800$. It is obvious that the delay period T_0 is larger than that of the controller in (63). This consequently affects the learning period, the transient response, and the tracking performance of the closed-loop system with the controller $u(k)$ in (64) as shown in Fig. 4. The peak values of its transient response are larger than those shown in Fig. 3(a). Moreover, longer convergence time is also depicted in Fig. 4(b) as compared to that presented in Fig. 3(b). In this case, Fig. 4(b) clearly shows that both the tracking error $e(k)$ and the sliding function $s(k)$ converge after 4 s.

Another comparison was also carried out with respect to the performance and robustness of the ordinary multiple-period RC (MP-RC) method (Kurniawan *et al.*, 2017), which yields

$$u(k) = \mathcal{Z}^{-1} [E(z)u(z)] + \mathcal{Z}^{-1} \left[z \frac{A(z)}{B(z)} E(z)e(z) \right], \quad (65)$$

where $E(z)$ is equal to that in (61).

Here, we consider two cases where the system (57), (58) is subject to parametric uncertainties due to variations in the coefficients of the polynomials $A(z)$ and $B(z)$. That is,

- Case 1 (2.5% variation): $b_0 = 0.0744$, $b_1 = 0.0699$, $a_0 = -1.7092$, $a_1 = 0.879$.
- Case 2 (5% variation): $b_0 = 0.0725$, $b_1 = 0.068$, $a_0 = -1.6653$, $a_1 = 0.8564$.

When the system parameters deviate from their nominal values, there will be a considerable mismatch between the nominal system dynamics and the learning

functions ($M^{-1}(z)$ and $z^d A(z)/B(z)$ for the MP-VSRC and the MP-RC method, respectively). Such a mismatch renders perfect compensation no longer possible and may also lead to slow convergence and instability. This phenomenon is depicted in Fig. 5(a), where the tracking error $e(k)$ affected by the parametric uncertainties converges slower than that of the nominal case shown in Fig. 3(b). Also, as shown in Fig. 5(a), the closed-loop systems yielded by both the MP-VSRC and MP-RC methods remain stable despite the parametric variations considered in Case 1. When more parametric uncertainties are present as in Case 2, the MP-VSRC method is still able to maintain the closed-loop stability, but the corresponding tracking error $e(k)$ becomes slower to converge. This is in contrast to the MP-RC method, which can no longer preserve the closed-loop stability in Case 2. Therefore, as compared with the MP-RC method, the MP-VSRC one is relatively more robust against the parametric uncertainties, as shown in Fig. 5(b).

6. Conclusion

This paper has proposed a new method to synthesize the discrete-time multiple-period variable-structure repetitive controller for a stable and minimum-phase linear system perturbed by multiple-period exogenous signals. The control objective is to simultaneously track the reference signal and to reject the disturbance signal composed of multiple fundamental periods. The proposed control method is aimed at achieving a fast transient response and robustness against parametric uncertainties. Simulation results show that the MP-VSRC method is capable of attaining the control objective and the robustness requirement with relatively small transient errors and fast convergence of tracking errors.

References

- Bartoszewicz, A. and Lesniewski, P. (2016). New switching and nonswitching type reaching laws for SMC of discrete time systems, *IEEE Transactions on Control Systems Technology* **24**(2): 670–677.
- Chen, S., Lai, Y.M., Tan, S.C. and Tse, C.K. (2009). Fast response low harmonic distortion control scheme for voltage source inverters, *IET Power Electronics* **2**(5): 575–584.
- Chen, X. and Tomizuka, M. (2014). New repetitive control with improved steady-state performance and accelerated transient, *IEEE Transactions on Control Systems Technology* **22**(2): 664–675.
- Flores, J.V., Da Silva, J.M.G., Pereira, L.F.A. and Sbarbaro, D.G. (2012). Repetitive control design for MIMO systems with saturating actuators, *IEEE Transactions on Automatic Control* **57**(1): 192–198.

- Francis, B. and Wonham, W. (1975). The internal model principle for linear multivariable regulators, *Applied Mathematics and Optimization* **2**(2): 170–194.
- Gao, W., Wang, Y. and Homaifa, A. (1995). Discrete-time variable structure control systems, *IEEE Transactions on Industrial Electronics* **42**(2): 117–122.
- Grino, R. and Costa-Castello, R. (2005). Digital repetitive plug-in controller for odd-harmonic periodic references and disturbances, *Automatica* **41**(1): 153–157.
- Hillerstrom, G. and Walgama, K. (1996). Repetitive control theory and applications—A survey, *IFAC Proceedings Volumes* **29**(1): 1446–1451.
- Hornik, T. and Zhong, Q.-C. (2011). A current-control strategy for voltage-source inverters in microgrids based on h_∞ and repetitive control, *IEEE Transactions on Power Electronics* **26**(3): 943–952.
- Kurniawan, E., Afandi, M.I. and Suryadi, S. (2017). Repetitive control system for tracking and rejection of multiple periodic signals, *Proceedings of the 2017 International Conference on Robotics, Automation and Sciences, Melaka, Malaysia*, pp. 1–5.
- Kurniawan, E., Cao, Z. and Man, Z. (2014). Design of robust repetitive control with time-varying sampling periods, *IEEE Transactions on Industrial Electronics* **61**(6): 2834–2841.
- Kurniawan, E., Cao, Z., Mitrevska, M. and Man, Z. (2016a). Design of decentralized multi-input multi-output repetitive control systems, *International Journal of Automation and Computing Science* **13**(6): 615–623.
- Kurniawan, E., Wardoyo, R. and Gojali, E.A. (2016b). Tracking and robust performance of discrete-time model-based controller, *Proceedings of the 2016 International Conference on Computer, Control, Informatics and Its Applications, Jakarta, Indonesia*, pp. 28–32.
- Li, C.X., Gu, G.Y., Yang, M.J. and Zhu, L.M. (2017). High-speed tracking of a nanopositioning stage using modified repetitive control, *IEEE Transactions on Automation Science and Engineering* **14**(3): 1467–1477.
- Longman, R.W. (2010). On the theory and design of linear repetitive control systems, *European Journal of Control* **16**(5): 447–496.
- Lorenzini, C., Flores, J.V., Pereira, L.F.A. and Pereira, L.A. (2018). Resonant-repetitive controller with phase correction applied to uninterruptible power supplies, *Control Engineering Practice* **77**: 118–126.
- Lu, Y.S., Wu, B.X. and Lien, S.F. (2012). An improved sliding-mode repetitive learning control scheme using wavelet transform, *Asian Journal of Control* **14**(4): 991–1001.
- Ma, H., Li, Y. and Xiong, Z. (2019). Discrete-time sliding-mode control with enhanced power reaching law, *IEEE Transactions on Industrial Electronics* **66**(6): 4629–4638.
- Mingxuan, S., Youyi, W. and Wang, D. (2005). Variable-structure repetitive control: A discrete-time strategy, *IEEE Transactions on Industrial Electronics* **52**(2): 610–616.
- Mitrevska, M., Cao, Z., Zheng, J., Kurniawan, E. and Man, Z. (2018). Design of a robust discrete-time phase lead repetitive control in frequency domain for a linear actuator with multiple phase uncertainties, *International Journal of Control, Automation and Systems* **16**(6): 2609–2620.
- Muramatsu, H. and Katsura, S. (2018). An adaptive periodic-disturbance observer for periodic-disturbance suppression, *IEEE Transactions on Industrial Informatics* **14**(10): 4446–4456.
- Owens, D.H., Li, L.M. and Banks, S.P. (2004). Multi-periodic repetitive control system: A Lyapunov stability analysis for MIMO systems, *International Journal of Control* **77**(5): 504–515.
- Pérez-Arancibia, N.O., Tsao, T.C. and Gibson, J.S. (2010). A new method for synthesizing multiple-period adaptive-repetitive controllers and its application to the control of hard disk drives, *Automatica* **46**(7): 1186–1195.
- Rashed, M., Klumpner, C. and Asher, G. (2013). Repetitive and resonant control for a single-phase grid-connected hybrid cascaded multilevel converter, *IEEE Transactions on Power Electronics* **28**(5): 2224–2234.
- Sakthivel, R., Selvaraj, P. and Kaviarasan, B. (2020). Modified repetitive control design for nonlinear systems with time delay based on T–S fuzzy model, *IEEE Transactions on Systems, Man, and Cybernetics: Systems* **50**(2): 646–655.
- Sun, Y., Qiang, H., Mei, X. and Teng, Y. (2018). Modified repetitive learning control with unidirectional control input for uncertain nonlinear systems, *Neural Computing and Applications* **30**: 2003–2012.
- Tomei, P. and Verrelli, C.M. (2015). Linear repetitive learning controls for nonlinear systems by Padé approximants, *International Journal of Adaptive Control and Signal Processing* **29**(6): 783–804.
- Wang, Y., Wang, R., Xie, X. and Zhang, H. (2018). Observer-based h_∞ fuzzy control for modified repetitive control systems, *Neurocomputing* **286**: 141–149.
- Zhang, J., Shi, P., Xia, Y. and Yang, H. (2019). Discrete-time sliding mode control with disturbance rejection, *IEEE Transactions on Industrial Electronics* **66**(10): 7967–7975.
- Zhou, L., Cheng, L., She, J. and Zhang, Z. (2019). Generalized extended state observer-based repetitive control for systems with mismatched disturbances, *International Journal of Robust and Nonlinear Control* **29**(11): 3777–3792.
- Zhou, L., She, J., Li, C. and Pan, C. (2016). Robust aperiodic-disturbance rejection in an uncertain modified repetitive-control system, *International Journal of Applied Mathematics and Computer Science* **26**(2): 285–295, DOI: 10.1515/amcs-2016-0020.
- Zhou, L., She, J., Zhang, X.M., Cao, Z. and Zhang, Z. (2020). Performance enhancement of repetitive-control systems and application to tracking control of chuck-workpiece systems, *IEEE Transactions on Industrial Electronics* **67**(5): 4056–4065.



Edi Kurniawan received his BEng degree from Gadjah Mada University, Yogyakarta, Indonesia, in 2003, and his MEng degree from the University of Adelaide, Australia, in 2009, both in electronics and electrical engineering. He received his PhD degree in control systems from the Swinburne University of Technology, Hawthorn, Australia, in 2013. He is currently a senior researcher at the Research Center for Physics, Indonesian Institute of Sciences, Tangerang Selatan. His research interests include learning control, drone control, and image processing.



Hendra G. Harno received a BEng degree (2001) in aeronautical engineering from the Bandung Institute of Technology, Indonesia, and an MSc degree (2005) in applied mathematics from the University of Twente, the Netherlands. He received a PhD degree (2011) in electrical engineering from the University of New South Wales, Australia. Since 2018, he has been a senior researcher at the Department of Aerospace and Software Engineering, Gyeongsang National University, Republic of Korea. His research interests include nonlinear and robust control, reachability analysis, optimization, and control applications in flight control and electro-mechanical systems.



Sensus Wijonarko received his BEng (1985) and Ir (Ingenieur) (1986) degrees from Gadjah Mada University, Yogyakarta, Indonesia, in electronics and electrical engineering, and his MSc degree from the UMIST (University of Manchester Institute of Science and Technology) and the Victoria University of Manchester (the two universities are now reunited as the University of Manchester) in 1998 in instrument design and applications. He received his PhD degree in environmental engineering from Jakarta State University, Indonesia, in 2009. He is currently a senior researcher at the Research Center for Physics, Indonesian Institute of Sciences, Tangerang Selatan. His research interests include hydrometeorological instrumentation and optoelectronics.



Bambang Widiyatmoko received his BSc degree from the Physics Department, Gadjah Mada University, Yogyakarta, Indonesia, in 1987. He received his MEng and DrEng degrees in applied electronics from the Tokyo Institute of Technology, Japan, in 1995 and 2000, respectively. He is currently a senior researcher at the Research Center for Physics, Indonesian Institute of Sciences, Tangerang Selatan. His research interests include instrumentation, laser and optoelectronics.



Dwi Bayuwati received a BSc degree from the Bandung Institute of Technology (ITB), Indonesia, in 1984, majoring in solid state physics, and an MEngSc degree from the University of New South Wales, Australia, in 1991, majoring in optical communication. She is currently a senior researcher at the Research Center for Physics, Indonesian Institute of Sciences, Serpong. Her research interests include optical components, fiber optic sensors and optoelectronics.



Purwowibowo Purwowibowo received his MEng in mechanical engineering in 2001 and his PhD in electrical engineering in 2008 from the University of Indonesia. From 1986 to 2018, he was a researcher and worked in the managerial position at the Research Center for Calibration, Instrumentation and Metrology, Indonesian Institute of Sciences. In 2019, he joined the Research Center for Physics there as a senior researcher. His research focuses on the application of micro-controller in instrumentation, particularly on programming and intelligent system-on-chip. His research interests also include mechatronics, data acquisition and genetic algorithms.



Tatik Maftukhah received a BSc degree from Sebelas Maret University, Indonesia, in mathematics in 1993 and an MEng degree in instrumentation and control from the Bandung Institute of Technology, Indonesia, in 2002. She received a PhD degree in computer science from the University of Indonesia in 2010. She is currently a senior researcher at the Research Center for Physics, Indonesian Institute of Sciences, Tangerang Selatan. Her research interests are related to instrumentation technologies.

Appendix

Proof of the properties (17)–(19)

We begin with proving $P1$ in (17) as follows. Every period composing the signals $r(k)$, $w(k)$, and $v(k)$ is an element of $\{T_i\}$ for $i = 1, 2, \dots, h + j$. Now, suppose the periodic reference signal $r(k)$ has a period T_1 . Then

$$\begin{aligned} I_M(z)r(z) &= r(z) \prod_{i=1}^{h+j} (1 - z^{-N_i}) \\ &= (r(z) - r(z)z^{-N_1}) (1 - z^{-N_2}) \dots \\ &\quad (1 - z^{-N_{h+j}}). \end{aligned} \quad (A1)$$

Taking the inverse \mathcal{Z} -transform of (A1), we obtain

$$\begin{aligned}
 & \mathcal{Z}^{-1} [I_M(z)r(z)] \\
 &= [r(k) - r(k - TN_1)] \\
 & \quad * \mathcal{Z}^{-1} [(1 - z^{-N_2}) \dots (1 - z^{-N_{h+j}})] \\
 &= [r(k) - r(k - T_1)] \\
 & \quad * \mathcal{Z}^{-1} [(1 - z^{-N_2}) \dots (1 - z^{-N_{h+j}})] \\
 &= 0 * \mathcal{Z}^{-1} [(1 - z^{-N_2}) \dots (1 - z^{-N_{h+j}})] = 0. \quad (\text{A2})
 \end{aligned}$$

This completes the proof for $P1$. Note that $*$ denotes the convolution operator. It then follows that $P2$ and $P3$ in (18) and (19) can be proved in the same fashion as above.

Received: 22 August 2019

Revised: 22 January 2020

Accepted: 2 March 2020