

## Jak nie porównywać wyników badań bioelektromagnetycznych

### HOW TO NOT COMPARE RESULTS IN BIOELECTROMAGNETIC STUDIES

Tomasz Długosz<sup>1</sup>

**Streszczenie:** Artykuł poświęcony jest problemom związanym z porównywaniem wyników badań bioelektromagnetycznych. Można zauważyć, że badania poświęcone wpływom pola elektromagnetycznego, zwłaszcza na obiekty biologiczne, dają niejednoznaczne wyniki, które ciężko porównać między różnymi ośrodkami naukowymi. Wiele błędów wynika z technicznych aspektów tego typu eksperymentów. W pracy przedstawiono wybrane z nich. W badaniach nie wykorzystywano obiektów biologicznych, a jedynie ich numeryczne modele.

**Abstract:** The paper is devoted to the problem of difficulty in results comparison of bioelectromagnetic experiments. It may be noticed that many studies which are devoted to biological effects of electromagnetic field exposure on biological objects can not be compared to each other. There may be many reasons responsible for that state. Certainly one of them are different sources of uncertainty resulting from the technical aspects of this type of research. One such source is influence of exposure system on tested object.

**Słowa kluczowe:** badania bioelektromagnetyczne, metody numeryczne, pole elektromagnetyczne, dokładność badań, układy ekspozycyjne

**Keywords:** bioelectromagnetic studies, electromagnetic field, accuracy of experiments, exposure systems, numerical methods

### Introduction

Increasing usage of electronic equipment and wireless telecommunication systems in almost all aspects of our lives has caused interest of society about electromagnetic field (EMF). Whole environment is intentionally or unintentionally exposed to EMFs. This exposure creates a risk which is current subject of studies in bioelectromagnetics experiments. Especially important issues are biomedical studies exploring the effects of EMFs on human [1]-[7].

One of the most important problem in bioelectromagnetics studies is accuracy one. Bioelectromagnetic research is one of the least accurate and difficult to perform. In many cases the tests are performed when the EMF exposure is significantly different from the one to which objects are exposed to in real life. In order to improve the accuracy it is necessary to increase the comparability of results obtained in different labs. Estimates made by the author show that due to interaction between the tested objects and the exposure system and among objects themselves, errors may exceed even 100% [8][9]. These phenomena are the reason for significant differences in the results of research done in different research centres.

The aim of this paper is to focus attention of experimenters on one phenomenon that is not taken into account in the majority of experiments and may lead to complete falsification results of experiments.

### Object under test inside exposure system

Transverse Electro-Magnetic (TEM) line (Fig. 1) is one of the most popular exposure system that is very often used in electromagnetic compatibility tests or in bioelectromagnetics experiments [9][10]. It may be used for antenna's calibration, electromagnetic compatibility investigations and biomedical studies.

TEM cells have many advantages, like the wide frequency range from DC to hundreds megahertz, good isolation from external environment, frequency independent field intensity, relatively small costs. But there are also some limitations: influence of line on object, mutual interactions between the cell and object, problems with larger objects testing at high frequencies, non-ideal EMF distribution, resonances and the presence of higher modes.

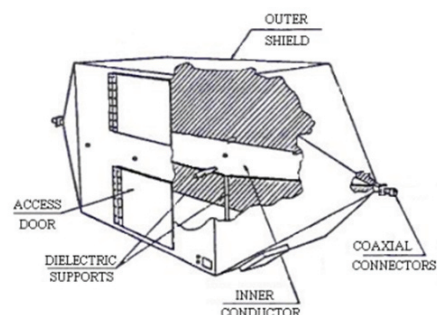

a)

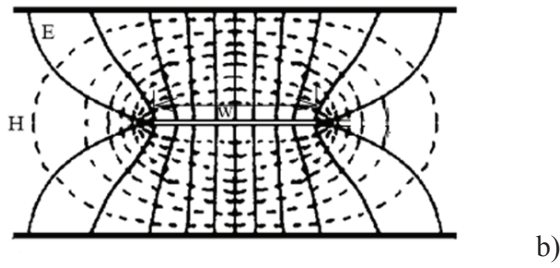

Fig. 1. TEM line as exposure system: a) construction, b) a cross section of open-ended line

Placing any object with conductivity different than zero in the EMF causes certain losses. If the values of the electric field intensity and conduction current density are known, then the power loss that is absorbed by the objects is described by the formula

$$P_{abs} = \int_V EJ dV \quad (1)$$

where:

$P_{abs}$  – absorbed power,

$E$  – electric field density vector,

$J$  – current density vector,

$V$  – volume of the object.

Substituting into (1) as  $J$

$$J = \sigma E \quad (2)$$

where:

$\sigma$  - conductivity of tested object

and making simple transformations, we get the power absorbed by an object placed in the EMF, given by

$$P_{abs} = \sigma \int_V E dV \quad (3)$$

Formula (3) is true if the tested object is homogeneous. Otherwise, a formula that takes into account the quasi-homogenous volumes  $V_N$  in all  $N$  areas of different conductivity is used

$$P_{abs} = \sigma_1 \int_{V_1} |E_1|^2 dV_1 + \sigma_2 \int_{V_2} |E_2|^2 dV_2 + \dots + \sigma_N \int_{V_N} |E_N|^2 dV_N \quad (4)$$

Calculating absorbed power allows to see how exposure system influences on tested object [9][11].

## Materials and methods

It is well known that the primary tool for quantitative research is hands-on experimentation and measurements. Unfortunately, the tests are not always possible due to high complexity of the studied objects, lack of appropriate sensors or their inaccuracy. This is especially important in the measurement of EMF. It is worth mentioning that any physical quantity measured (i.e.: frequency) are performed with 10<sup>100</sup>% accuracy, whereas the error in creating a standard EMF equals 5%-10%. That influences the test tools' accuracy whose error can't exceed the one of creating EMF. Further appears the question of ethics of such tests. Experiments examining EMF's influence on human body are acceptable with person's consent, but still controversial. The same applies to the use of animals for this type of research. Above arguments show that bioelectromagnetic testing is a challenge, and is often impossible to perform. This is where use of mathematical models and computer programs based on numeric methods comes in handy. These tools give us some insight on the expected results. Similar results from different numerical methods can be considered as exemplary and reliable

The most important feature and the biggest advantage of computer simulations using numerical methods is their ability to predict the behavior of the actual object based on its mathematical model. It is much easier and faster to perform computer simulations, rather than perform the measurements in real life conditions. Computer simulations are also extremely useful when the experiments are too dangerous to perform, i.e.: when the researched EMF can cause health issues or death of tested objects. Major drawbacks of computer simulations are restraints of computing resources and long duration of the calculations.

All presented in this paper results were obtained by Finite Element Method (FEM) and Finite Difference Time Domain method (FDTD) [12][13].

In the above simulations, real TEM line (Fig. 2a) was replaced by two conductive surfaces (Fig. 2b). Six models (I-VI) of different sizes of TEM line were used. They varied one dimension – distance (d) between plates (Fig. 3).

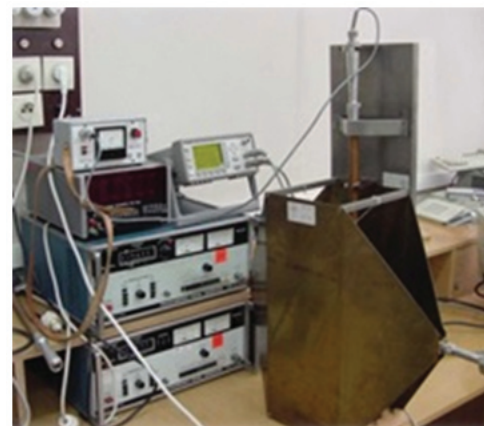

a)

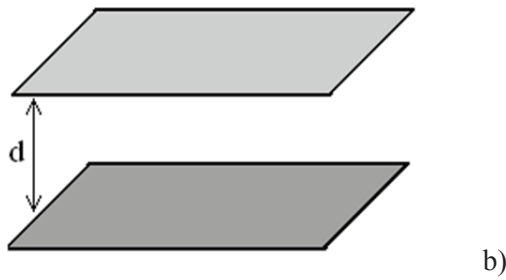

Fig. 2. TEM line: a) real exposure system b) simplified model

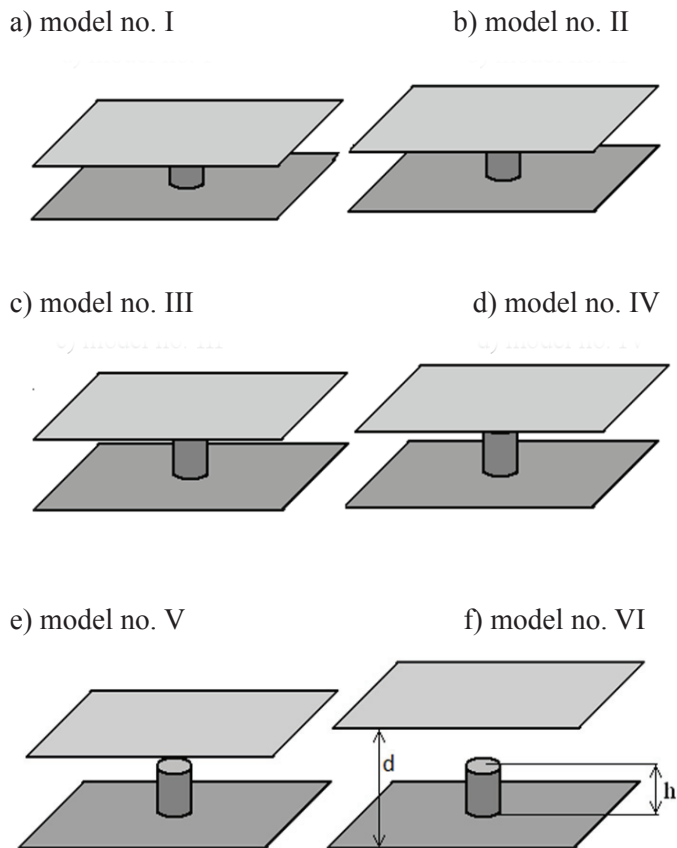

Fig. 3. TEM cell with tested object in function of distance between plates: a)  $d/h=1,0$ , b)  $d/h=1,2$ , c)  $d/h=1,4$ , d)  $d/h=1,6$ , e)  $d/h=1,8$ , f)  $d/h=2,0$

In each case electric field inside  $E$  was the same  $1 \text{ V/m}$ . Inside those exposure systems an tested object was placed. It was simplified cylindrical heterogeneous model of a human. Its electrical parameters equal  $\epsilon = 80$ ,  $\sigma = 0.84 \text{ S/m}$ .

## Results

Results of calculations are shown in Fig. 4. It may be noticed that the size of the exposure system has a significant impact on the quantity of absorbed energy. The same tested object placed in the same EMF's conditions absorbed different portion of energy in each of exposure system.

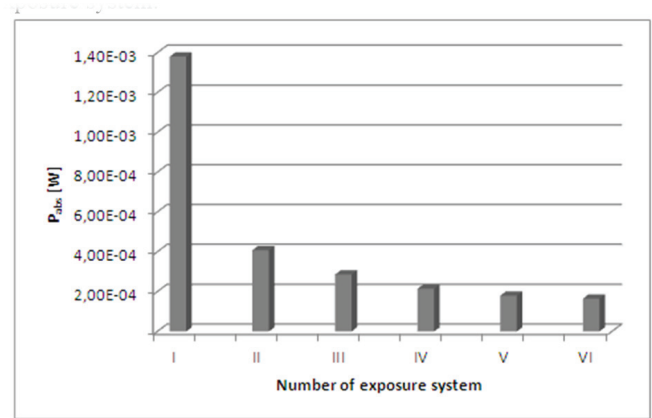

Fig. 4. Power absorbed by the same object placed in the same EMF within exposure system of different sizes

The results of changes in the power absorption as a function of the exposure and system's size are shown in Fig. 5. It is worth mentioning that when the plates of TEM line are close to the object the power absorbed is 30 times higher compared to the conditions of free space. Increase in the  $d/h$  ratio causes the absorbed power to decrease and approach asymptotically the value of absorbed power in free space, where the presence of metal plates is negligible. This condition is met for  $d/h \approx 2$ .

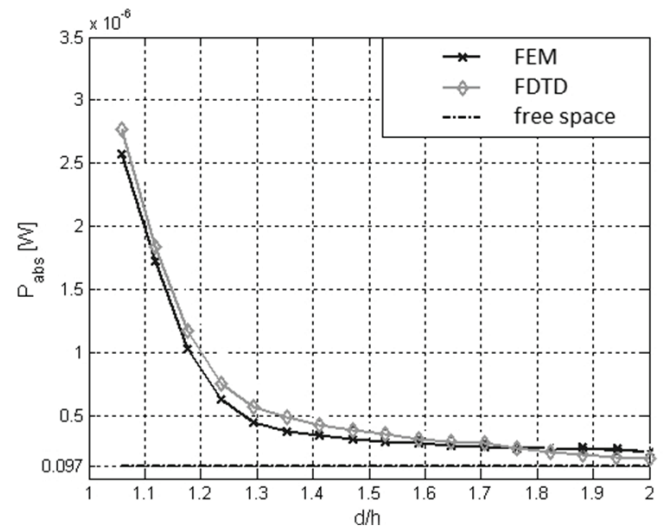

Fig. 5. The results of calculations of absorbed power by the cylindrical model of a human placed perpendicular to the plates of the walls

The estimations are the most primitive ones, however, they show a role of the conducting plates presence upon the absorption. Apart from the presence of couplings with the exposure system (plates) the same effect exists between objects (if more than one). Effect increases with frequency and complexity of tested object. The phenomenon loses its importance for  $d \approx 2h$ .

Presented results show clearly that not only EMF parameters should be the same when we want to compare results. Also dimensions of exposure system play important role. When different sizes exposure systems are used than significant errors are made (Fig. 6).

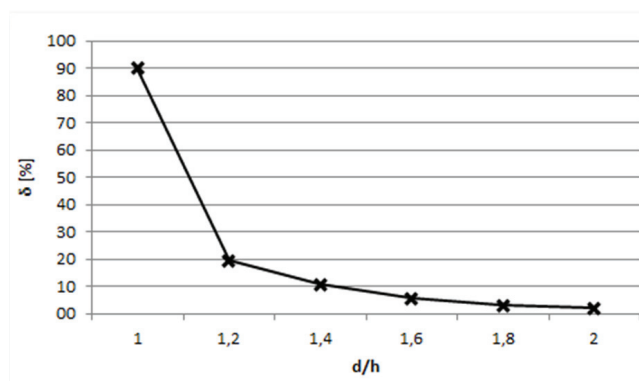

Fig. 6. Accuracy estimations of bioelectromagnetic experiment versus size of exposure system

## Conclusion

A lot of studies is currently devoted to biological effects as a result of EMF exposure but very often they are irreproducible and contradictory. One of the reasons may be not taking into account uncertainty of such experiments. There are a lot of sources of errors in that kind studies. One of them is influence of exposure system on tested object what was presented in this paper.

It is important, to all of us, to start cooperation between biologists, physicians and engineers, because sources of errors in such experimnts are twofold: technical [8] and biological [14].

## REFERENCES

- [1] Ibey, B. L., Roth, C.C., Ledwig, P. B., Payne J.A., Amato A.L., Dalzell D.R., Bernhard J.A., Doroski M.W., Mylacraine K.S., Seaman R.L., Nelson G.S., Woods C.W., "Cellular effects of acute exposure to high peak power microwave systems: Morphology and toxicology", *Bioelectromagnetics*, Vol. 37, Issue 3, 2016, pp. 141-151.
- [2] Calvente, I., Pérez-Lobato, R., Núñez, M.I, Ramos R., Guxens, M., Villalba, J., Olea, N., Fernandez, M.F., "Does exposure to environmental radiofrequency electromagnetic fields cause cognitive and behavioral effects in 10-year-old boys?", *Bioelectromagnetics*, Vol. 37, Issue 1, 2016, pp. 25-36.
- [3] Wuschech, H., Hehn, U., Mikus, E., Funk, R. H. "Effects of PEMF on patients with osteoarthritis: results of a prospective, placebo-controlled, double-blind study", *Bioelectromagnetics*, Vol. 36, Issue 8, 2015, pp. 576-585.
- [4] Varsier, N., Plets, D., Corre, Y., Vermeeren, G., Joseph, W., Aerts, S., Martens, L., Wiart, J., "A novel methods to assess human population exposure induced by a wireless cellular network", *Bioelectromagnetics*, Vol. 36, Issue 6, 2015, pp. 451-463.
- [5] Markov, M. S., "Electromagnetic Fields in Biology and Medicine", *CRC Press*, 2015.
- [6] Scientific Committee on Emerging Newly Identified Health Risks, "Opinion on Potential Helath Effetcs of

Exposure to Electromagnetic Fields", *Bioelectromagnetics*, Vol. 36, Issue 6, 2015, pp. 480-484.

[7] Boriraksantikul, N., Bhattacharyya K. D., Whiteside, P.J.D., O'Brien, C., Kirawanich, P., Viator, J.A., Islam, N.E., "Case Study of High Blood Glucose Concentration Effects of 850 MHz Electromagnetic Fields Using Gtem Cell", *Progress In Electromagnetics Research B*, Vol. 50, 2012, pp. 55-44.

[8] Dlugosz, T., "Uncertainty Analysis of selected Sources of Errors in Bioelectromagnetic Investigations", *Bio-Medical Materials and Engineering 1*, 2014, pp. 609-617.

[9] Dlugosz, T., Trzaska, H., Mutual interactions in bioelectromagnetics, *The Environmentalist 4*, 2007, pp. 403-409.

[10] Crawford, M., L., "Generation of Standard EM Field Using TEM Transmission Cell", *IEEE Transactions on Electromagnetic Compatibility*, Vol. EMC-16, Issue 4, 1974, pp. 189-195.

[11] Dlugosz, T., Trzaska, H., "Proximity Effects in the Near-field EMF Metrology", *IEEE Transaction on Instrumentation and Measurement*, Vol. 57, Issue 11, 2008, pp. 626-630.

[12] Huebner, K.,H., Thornton, E., A., "The Finite Element Method for Engineers", *John Wiley and Sons*, 1982.

[13] Taflove, A., "Computational Electrodynamics: The Finite-Difference Time-Domain Method", *Artech House Antennas and Propagation Library*, 1996.

[14] Buchachenko, A., "Why Magnetic and Electromagnetic Effects in Biology Are Irreproducible and Contradictory?", *Bioelectromagnetics*, Vol. 37, Issue 1, 2016, pp. 1-13.