

*Robert Cichowicz, Artur Waclaw Stelegowski*

**Lodz University of Technology, Department of Environmental Engineering and Building Construction  
Installations, Faculty of Architecture, Civil and Environmental Engineering**

al. Politechniki 6, 90-924 Lodz, Poland, robert.cichowicz@p.lodz.pl, arturstelegowski@gmail.com

## **NUMERICAL ANALYSIS OF THE SELECTED AIR PARAMETERS IN THE INDUSTRIAL BOILER PLANT**

### **Abstract**

In every boiler plant, including industrial boiler plants of thermal capacity above 2 MW, substantial heat gains are generated during the work of combustion units. As a result, the indoor air temperature raises in the room, which affects thermal comfort of workers operating such technological installations. Therefore, heat removal requires an effective mechanical ventilation system. A numerical analysis of the selected air parameters in a room equipped with combustion devices was undertaken using computational fluid dynamic (CFD) simulations in the DesignBuilder software. This was done for a combustion plant in the "Installation of Thermal Treatment of Sewage Sludge" building, located in the "Group Sewage Treatment Plant" complex of Lodz, Poland. The numerical analysis was based on experimental measurements and the results concerning the personnel work area were compared to the guidelines of the ISO international standard 7730:2005.

### **Key words**

thermal comfort; air parameters; CFD analysis

### **Introduction**

The operation of combustion devices causes the emission of contaminants such as solid particles, gases, steam and heat [1-2]. The basic issue for industrial ventilation is the removal or decrease of contaminant concentration resulting from industrial processes [1, 4] to provide proper working conditions for the staff operating the industrial plant. Mechanical ventilation can also remove sensible heat gains derived from devices to ensure appropriate air parameters (such as temperature and velocity) in the staff work area [5]. The operation of such installation is based on a system equipped with air supply and air exhaust elements, which are used in general zoning and local ventilation [6, 7].

Additionally, there is a need to correctly calculate the ventilation airflow, which should result from the knowledge of technological processes used in the combustion plant [1, 5, 8]. Table 1 shows the airflow distribution approaches classified into four main ventilation system strategies: piston, stratification, zoning and mixing [9]. For example, the stratification strategy is intended to remove heat gains and air contaminants by supporting the convection and discharge of warmer, polluted air through the supply of low-momentum colder outdoor air. And the mixing strategy assumes providing a uniform distribution of heat and contaminants throughout the ventilated space.

Table 1. Ideal room air conditioning strategies

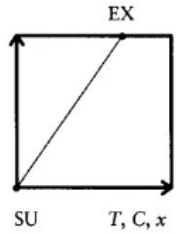
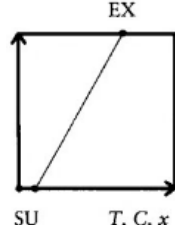
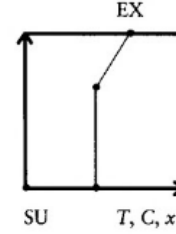
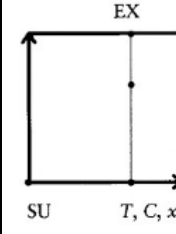
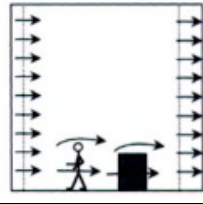
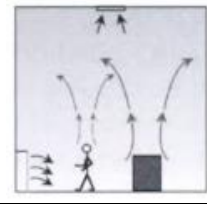
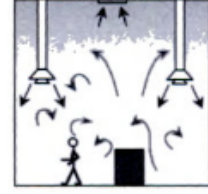
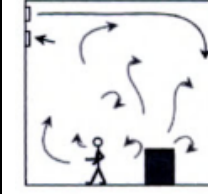
Strategy	Piston	Stratification	Zoning	Mixing
Description				
Heat, humidity and contaminant distribution*				
Application example in a room				
* SU – supply, EX – exhaust, x-axis: T – temperature, C – concentration of contaminants, x – humidity, y-axis: room height				

Source: [9]

The evaluation of regularity of technical and technological solutions for decreasing/removing the contaminant concentration, connected with the operation of combustion units, is possible using the analysis of air parameters in the work area of staff handling such devices. These parameters include air temperature and velocity, as well as humidity, impact of surfaces radiant temperature and the asymmetry of temperature distribution in the room, and are significant environmental factors affecting a sense of thermal comfort [10].

However, air parameters (temperature, humidity and velocity) must be connected with individual factors [10], such as the type of work [11], clothing [12-13] and physiological adaptation to working in hot environments (acclimatization) [14]. Indoor microclimate can be assessed through users' thermal sensation and therefore the PMV (Predicted Mean Vote), as well as PPD (Predicted Percentage of Dissatisfied) ranges, specified in the ISO international standard 7730:2005 [11] can be the indicators of local comfort in industrial buildings.

A calculated value of PMV is compared with 7-step scale of thermal sensation ranging from -3 (cold) do +3 (hot). The PPD index is a function of PMV value, and allows for the estimation of the percentage of population negatively evaluating the thermal environment. Using these indicators is restricted to some conditions such as when ambient temperature does not exceed + 30°C, when mean radiant temperature in the range of + 10 °C to + 40 °C, and when air velocity lower than 1.0 m/s. What is more, its usage can be flawed depending on ethnic and geographical differences [11, 15 - 16].

To assess the predicted thermal sensation in conditions of high air velocity in the room (e.g. with industrial ventilation system), one can use the corrected effective temperature index (CET), which specifies the thermal comfort sensation depending on air temperature, velocity and humidity [17]. The corrected effective temperature can be read from Yaglou graph [18], basing on the indication of dry bulb and wet bulb temperature, and air velocity at a specific point. Another approach to determine the required air parameters in the work area is the Wet Bulb Globe Temperature index (WGBT), defined in the ISO international standard 7243:1989 [14], which specifies threshold limit values for thermal load influencing humans during an eight hour working time in a hot environment. The criteria of thermal load differ depending on solar radiation, metabolic rate (from resting to very hard work) and acclimatization.

Thermal comfort conditions can be assessed using experimental measurements of air parameters at specific points of a room as well as conducting a theoretical analysis of the distribution of air temperature and velocity. Since it can be computationally onerous to analyze air parameters in the stage of designing or verification of technical solutions, the use of computer-aided numerical methods is appropriate [19 - 22].

One of these methods is known as CFD (Computational Fluid Dynamics) analysis and is used in both open-source and commercial software, such as OpenFOAM [23], ANSYS Fluent [24], PyroSim [25], and DesignBuilder [26]. This kind of software can provide a simulation of distribution of air velocity and temperature [27 - 28], as well as aid in optimizing technical solutions [29-30]. The result of CFD analysis, after being compared with experimental measurements, can be useful for assessing the effectiveness of removal or decreasing the concentration of contaminants in the air [31], and evaluating the extent the conditions of thermal comfort at a specific point in a room [27]. However, there is a lack of design criteria of thermal comfort for industrial rooms. Department stores are the closest to the metabolic rate of workers of a boiler plant as they conduct light industrial activity [11, 14]. Therefore, table 2 shows recommended values of indoor air temperature and velocity for light activity of workers in department stores, adopted from the standard ISO 7730:2005 [11].

Table 2. Design criteria for light activity

Comfort category	Metabolic rate	Temperature (summer)	Maximum air velocity (summer)
A	93 W/m <sup>2</sup>	+ 23.0 ± 1.0 °C	0.16 m/s
B		+ 23.0 ± 2.0 °C	0.20 m/s
C		+ 23.0 ± 3.0 °C	0.23 m/s

Source: [11]

The analysis of air parameters in the room was undertaken using geometrical model and numerical calculations conducted in DesignBuilder software. The evaluation of technical solutions for thermal comfort maintenance was conducted based on air temperature and velocity distribution in the room of industrial boiler plant in the “Installation of Thermal Treatment of Sewage Sludge” building, located in the “Group Sewage Treatment Plant” complex in Lodz, Poland.

#### Method description

The “Installation of Thermal Treatment of Sewage Sludge” building is located in the “Group Sewage Treatment Plant” complex of Lodz, and consists of one room of industrial boiler plant which was a simulation domain. The room analyzed is not intended for the constant presence of people. It has a cubic capacity of 12,136 m<sup>3</sup>. There is a mechanical ventilation system in the room designed to exhaust airflow at 180,000 m<sup>3</sup>/h, which provides approximately a 14.8 rate of air change per hour. The air exhaust is driven by 12 roof fans, located over the main heat sources. Each fan has a nominal air flow of 15,000 m<sup>3</sup>/h and a static pressure of 120 Pa. The air is supplied through 13 air intakes, located at the height of 2.49 m above the ground floor level. The dimensions are 2,000 mm x 1,000 mm (5 pieces) and 1,000 mm x 1,000 mm (8 pieces), with movable blinds connected to actuators coupled with roof exhaust fans. In the room, there are 2 technological process lines with a maximum total thermal capacity of 8.14 MW. Each line is equipped with a fluidized-bed incinerator (furnace) with a 4.07 MW maximum total thermal capacity, flue gas recuperator, steam heat recovery boiler, multicyclone, industrial bag filter and flue-gas stack (chimney) for removing the gaseous contaminants. Since those devices generate a significant amount of heat in the room, therefore there is no need for using a heating system in the building. In this analysis, the operation of only one technological line was assumed.

The first step of carrying out numerical calculations was to make a geometrical model of the building (fig. 1), and of the room and combustion devices (fig. 2), as well as setting up boundary conditions of outdoor air temperature, devices external surface temperature and air flow rate. The geometrical model includes all main elements affecting the temperature and velocity distributions, namely all partitions with windows, air intakes and air exhaust holes for roof fans, as well as larger equipment emitting heat. For the sake of simplifying the calculations, the model does not contain the steel structure of work platforms, mechanical equipment and lower diameter pipes. The room analyzed was divided into nearly 745,000 cells by general mesh spacing of 0.60 m, and local spacing of 0.10 m near the devices. The calculations were made using  $k - \epsilon$  turbulence model and upwind discretisation scheme [32]. The maximum dependent variable residual for the calculations was  $10^{-3}$ , and the number of iterations was over 4,000.

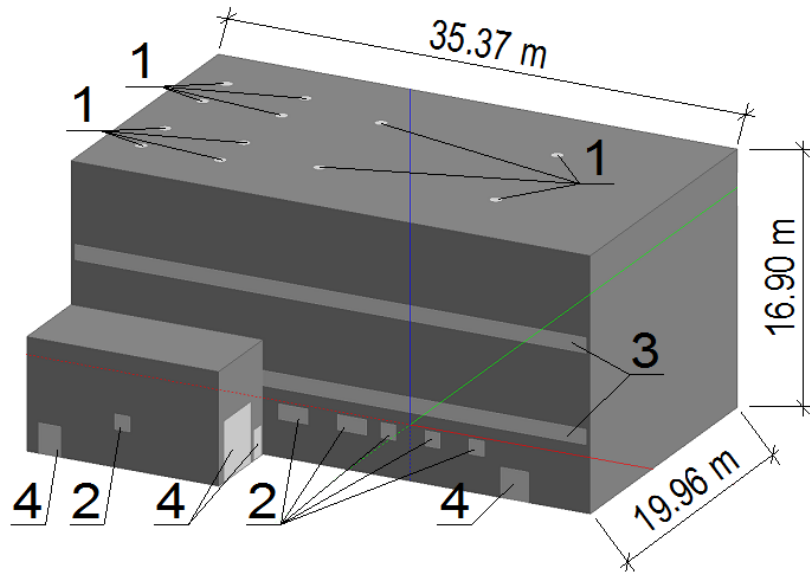

Fig. 1. Building geometrical model, where: 1 – exhaust roof fan, 2 – air intake, 3 – window, 4 - door  
 Source: Author's

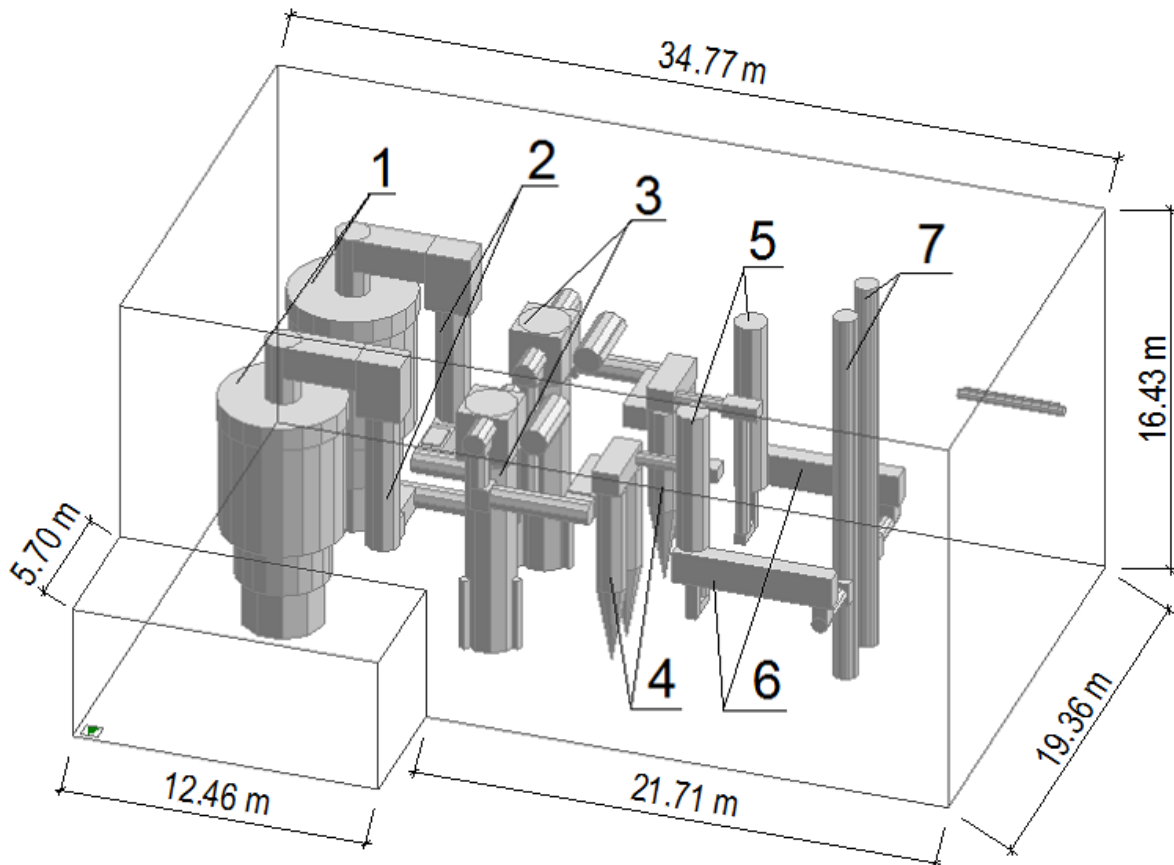

Fig. 2. Room geometrical model, where: 1 – furnace, 2 recuperator, 3 – boiler, 4 – multicyclone, 5 – steam cooling device, 6 – bag filter, 7 – chimney  
 Source: Author's

The boundary conditions (table 3) were set up basing on experimental measurements of device's external surface temperature, an external temperature sensor and data concerning installation of mechanical ventilation of the room. The temperature measurements of the external surface of the devices were carried out using a radiation pyrometer for each device on 1.50 m height above each subsequent working platform. The accuracy of the pyrometer was  $\pm 1.5$  K and default emissivity coefficient was 0.95. The results of the

measurements were averaged and calculated into an actual temperature using different values of emissivity coefficient of the materials examined  $\epsilon$ . The emissivity coefficient of a surface of the devices was assumed to be 0.88 for oxidized steel and 0.28 for galvanized steel [33]. The outdoor air temperature of + 25.0 °C was obtained from building automation system using an outdoor air temperature sensor located on the external wall of the building. The accuracy of the outdoor air temperature sensor was 0.22 K. The airflow for each fan and the total airflow for the room was obtained using design data that accounted for the number of operating roof fans. Each fan has a nominal air flow of 15,000 m<sup>3</sup>/h. From the total number of twelve fans, only nine were working, while two were out of order and one was removed. In the location of removed fan, the gravitational airflow was opened. The gravitational airflow of 2,340 m<sup>3</sup>/h was calculated using measuring results from an air velocity meter with 5% accuracy. Therefore the total ventilation airflow was 137,340 m<sup>3</sup>/h.

Table 3. Boundary conditions for numerical calculations

Boundary condition type	Value
Outdoor air temperature	+ 25.0 °C
Airflow through each fan	15,000 m <sup>3</sup> /h
Gravitational airflow through hole	2,340 m <sup>3</sup> /h
Total ventilation of ventilation system	137,340 m <sup>3</sup> /h
Temperature of external surface of the furnace*	+ 55.0-117.6 °C
Temperature of external surface of the recuperator*	+ 57.2-105.5 °C
Temperature of external surface of the other devices*	+ 37.0-61.9 °C
Temperature of external walls	+ 25.0 °C
Temperature of ground floor	+ 20.0 °C
* The devices were divided into parts of different measured temperatures of external surface, wherein the raise of the temperature occurs along with increase of height	

Source: Author's

The room analyzed has 8 levels of work area with the following floor heights and work platforms: ± 0.00 m, + 2.75 m, + 4.00 m, + 5.30 m, + 7.05 m, + 7.90 m, + 9.30 m and + 11.60 m. Because most work is done standing, the temperature and velocity of air was calculated on the height of head of the worker, which is 1.70 m above the floor level. In this article, the air parameters were analyzed on a sample of two heights (+ 1.70 m and + 11.00 m) from work areas and places where equipment maintenance takes place.

The outdoor air temperature was obtained using indication of temperature sensor located on the building wall. An impact of solar radiation and wind on indoor air conditions was omitted due to crucial influence of ventilation system and heat generated by combustion plant. The temperature of walls was assumed as 25.0°C, and the temperature of ground floor as 20.0°C. The temperature of supply air was set to 25.0°C. The validity of the simulation was assured using experimental measurements of air temperature in five points of the room on different heights from + 1.10 m to + 12.70 m. The measurements of air temperature were made using LSI LASTEM BSU102 psychrometer probe [34] with ± 0.19 K accuracy.

## Results

The verification of the simulation, comparing measured and CFD calculated air temperature in the room analyzed, showed an average comparison error of 6.4 % with CFD results overestimation at the lower parts of the rooms, and underestimation at the upper levels. The results of the numerical analysis were presented using the distribution of the air temperature and velocity. On the level of + 1.70 m, corresponding to height of head of employee, there was a rise in the ambient temperature from + 24.0°C near a non-operational process line + 25.2°C at a distance of 1.0 m from the furnace and other devices generating heat (fig. 3). A slight ambient

temperature increase is associated with the lower temperature of the devices in their lower parts. The analysis of the air temperature distribution shows that at the level of +1.70 m, thermal comfort requirements are fulfilled in approximately 90% of the area according to comfort category C during summer, which is specified in the ISO 7730:2005 standard [11]. A radiant asymmetry is not a concern in this case. An impact of hot surfaces of the devices on the thermal comfort can be assumed to be similar to an impact of a hot wall surface, which does not exceed 10% PPD [11]. This situation concerns the radiant asymmetry lower than 35°C. The ISO 7730:2005 standard [11] does not provide information on the impact of higher radiant asymmetry values on the thermal comfort.

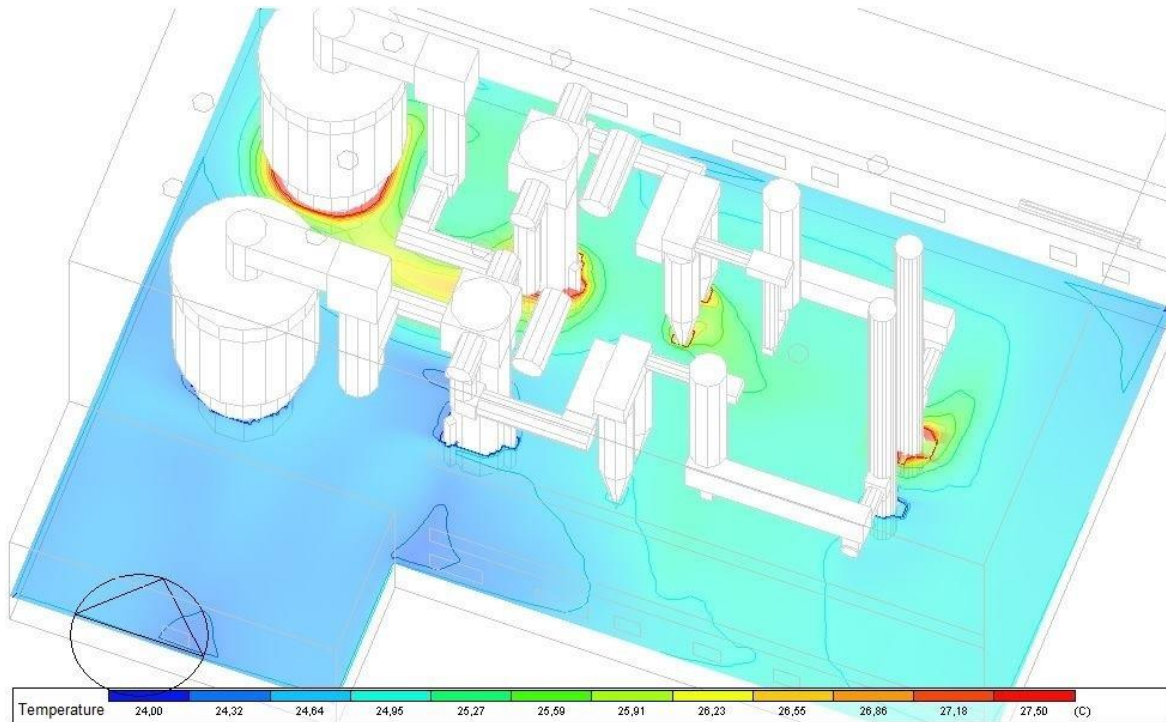

Fig. 3. Air temperature distribution on the level of + 1.70 m

Source: Author's

The analysis of the distribution of air velocity at the level of + 1.70 m shows significant changes of its value, from 0.00 m/s in the corners of the rooms, to 0.64 m/s in the vicinity of the operating process line, and above 1.00 m/s near the boiler and multicyclone (fig. 4). Those high values were associated with the location of air intakes at the level of +2.49 m, so the influence of the supply stream on the air conditions is noticeable in the analyzed area, where dominated speeds above 0.50 m/s predominated. The velocity comfort requirements during the summer were not fulfilled, as specified in the ISO 7730:2005 standard [11], because the air velocity should not exceed 0.23 m/s (table 2) in the work area.



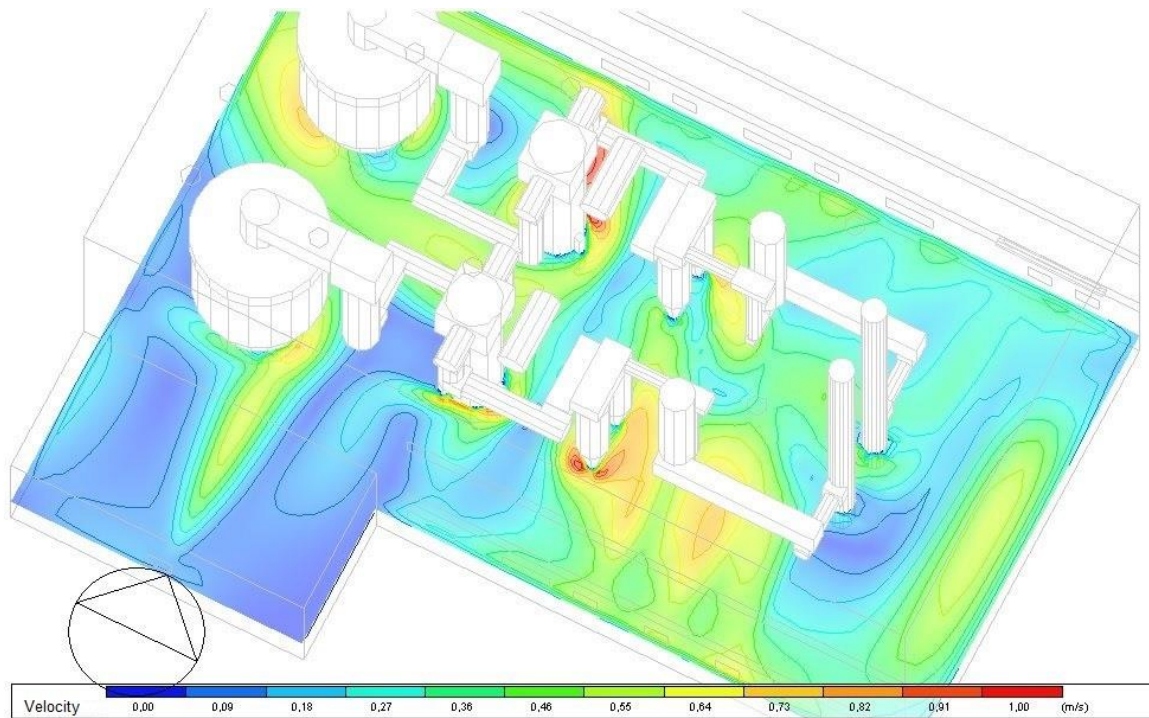

Fig. 4. Air velocity distribution on the level of + 1.70 m  
Source: Author's

At the level of + 11.00 m, which is the height of head of an employee while maintaining the devices on the 7th level of the work platform, it was a significant temperature rise, especially near the furnace, boiler and multicyclone (fig. 5). The temperature in the case analyzed varied from + 26.0 °C to + 32.0 °C at a distance of 1.0 m from the furnace to + 35.0 °C at a distance of 0.5 m from its rear section. The increase of air temperature near the heat sources is caused by the operation of mechanical ventilation lifting the heated air along the entire height of the devices. The major area has a temperature around +27.1 °C, which does not fulfill the thermal comfort requirements during summer, as specified in the standard of ISO 7730:2005 [11], because the air temperature should not exceed 26°C (table 2) in the work area.

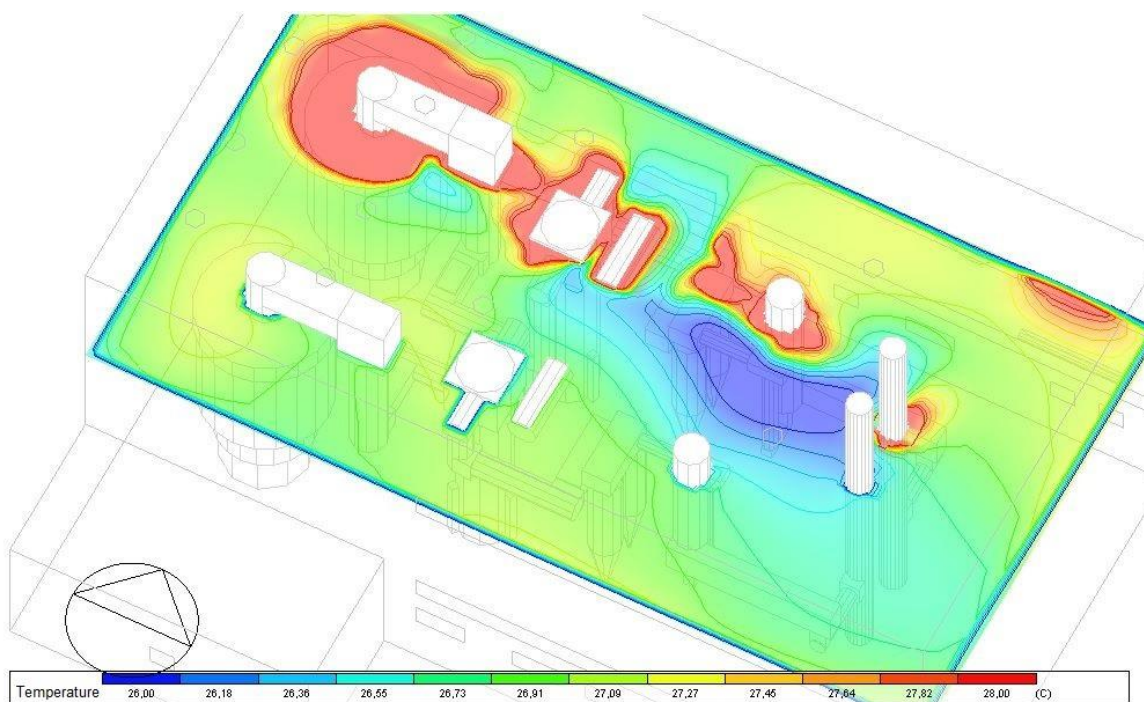

Fig. 5. Air temperature distribution on level of + 11.00 m  
Source: Author's

The analysis of air velocity distribution at the level of + 11.00 m showed lower variations than at the level of + 1.70 m. While on the lower level the air velocity is above 0.30 m/s in approximately 60% of the area, on upper level this value is exceeded only near the furnace, boiler and steam cooling devices. However, both levels showed similarly low air velocities (approximately 0.00 m/s) in the building corners and increased to 1.00 m/s near the operating technological line, where the velocity is in the range of 0.15-0.20 m/s (fig. 6), which fulfills category B requirements for velocity comfort during summer according to the ISO 7730:2005 standard [11].

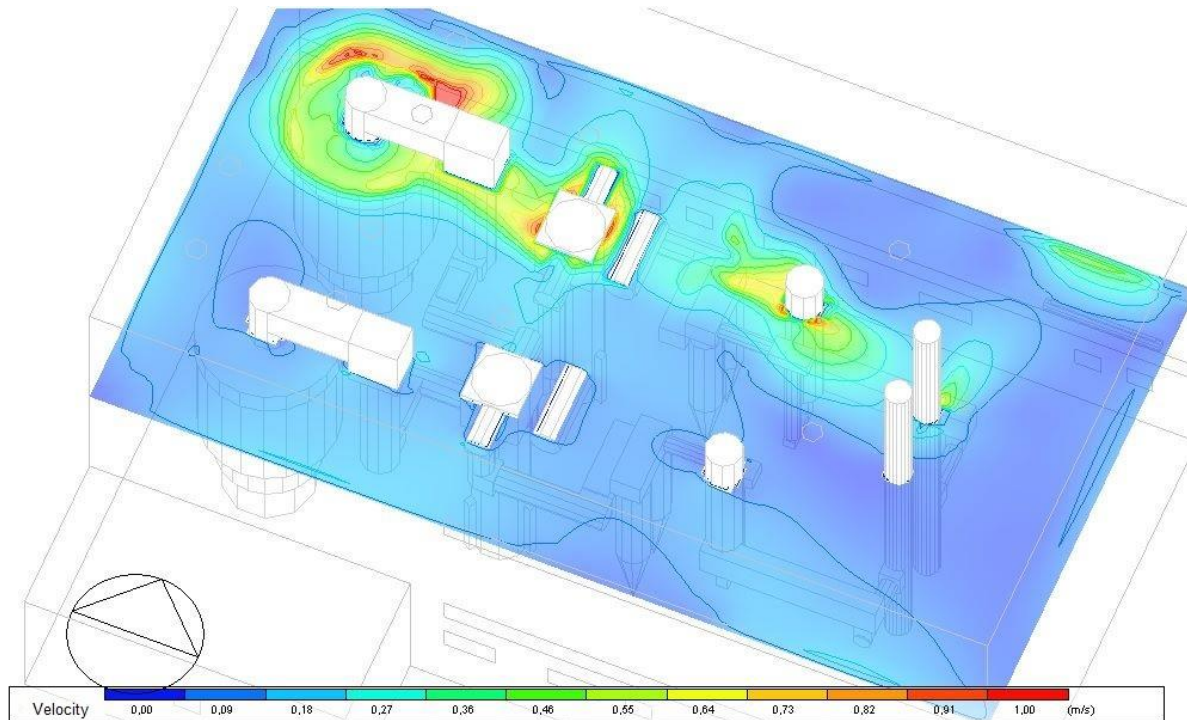

Fig. 6. Air velocity distribution on the level of + 11.00 m

Source: Author's

From the analysis carried out, it follows that the air temperature varied from + 23.5 °C near the non-operational process line to + 35.0 °C near the furnace, and the air velocities varied up to 1.0 m/s. The numerical analysis showed that at the + 1.70 m level, the comfort requirements for temperature were fulfilled in approximately 90% of the area. However, recommended air velocities were exceeded in approximately 80% of the area. A reverse phenomenon was noticed at +11.00 m, where the air velocity requirements were fulfilled in contrast to temperature requirements. Additionally, in the middle of the boilers (approximately 2.5 m distance) the air temperature at + 1.70 m was to + 25.3 °C with a velocity of 0.56 m/s, while at + 11.00 m it reached to + 27.0 °C with a velocity of 0.19 m/s. There was a threefold decrease of velocity, and a 0.57% increase of absolute temperature in this specific cross-section. Although the temperature rise seems small, it is sufficient to exceed the recommended values for light activity, indicating significant differences in the thermal comfort of people operating and maintaining combustion devices. It also shows the effectiveness of the removal of heat gains generated during the operation of combustion plant equipment, which was indicated by high air velocity (approximately 1.0 m/s) near the heat sources associated with process of hot air convection and by rapid drop in temperature. One meter away from those devices, the air temperature decreased to + 32 °C, down from + 117.6 °C at the external surface of the furnace.

In the room analyzed, the temperature rises along with height which indicates implementation of stratification strategy [9, 35] by ventilation system. However, the air is supplied on the bottom of the room at a high speed, which is characteristic for mixing strategy [9, 36] that assumes providing a uniform distribution of heat and contaminants throughout the ventilated space. The optimum solution of the industrial ventilation operation is to reach the lowest possible ratio of temperature in working zone to the temperature of air flowing from the room [9, 37], which was partly reached in the room analyzed. The comfort requirements in terms of temperature criterion are not fulfilled because the work platforms are located at a high level.



## Conclusions

The numerical analysis of air parameters in a room equipped with combustion devices indicates that thermal comfort requirements for workers conducting light activity from a standing position are not fulfilled, according to the ISO 7730:2005 [11] standard.

It was also found that the recommended air velocity was exceeded at +1.70 m, and the recommended air temperature at +11.00 m, which can cause negative thermal sensations of room's microclimate. The analysis of the air temperature and velocity indicated that the operation of mechanical ventilation, supported by convection streams of air heated from combustion devices, allows a significant removal of heat gains associated with thermal emission during the operation of combustion plant equipment. However, this solution does not meet the requirements of thermal comfort of workers in most working areas, especially when the outdoor air temperature is high and there are heat-generating devices in proximity. What is more, it is necessary to take under consideration that analysis was undertaken with condition of only one working technological line and in the case of operation of both process lines, the heat gains would increase. As a result, there would be an increase of ambient temperature and a worsening of thermal comfort conditions.

Meeting the workers' thermal comfort requirements needs an effective solution for heat gain removal and lower air supply velocities. Since the rating of local microclimate decreases with the rise of air temperature and velocity, the thermal comfort sensation goes down as one approaches combustion devices. Improvement of thermal comfort in the room analyzed can be achieved increasing thermal insulation of combustion devices and performing local exhaust ventilation extracting the hot air directly above them. This will prevent spreading the heat into the room. Applying local ventilation cooperating with general ventilation system facilitates better thermal conditions in a work zone, resulting from the reduction of heat gains and contaminants while simultaneously supplying fresh air [1]. Hermetization of the heat processes will probably effect in drop of the ventilation airflow, causing the reduction of velocities of the supply air, and consequently of the air velocities in the lower parts of the room. Decrease of the supply air velocities can also be obtained enlarging dimensions of the air intakes.

Providing thermal comfort in rooms not equipped with air-conditioning system become very problematic when outdoor air conditions cause a heat discomfort [15]. In the case analyzed, when workers are conducting light industry activity, the thermal requirements in the room will not be met for the air supply temperature over 26°C (table 2). Therefore, there is a need for operation of an air-conditioning system during the summer to maintain a thermal comfort in the industrial rooms.

The effectiveness of industrial ventilation is determined by the proper distribution of air and the knowledge about the amount of generated contaminants, heat and location of their sources [8]. The CFD analysis methods facilitate the optimization of technical solutions at the stage of industrial ventilation system design, as well as a verification of effectiveness of its operation [38].

## References

- [1] A. Charkowska, Wymagania ogólne i podstawowe zasady projektowania wentylacji dla obiektów przemysłowych (General requirements and basic rules of ventilation system design in industrial buildings), Special supplement IB – Ventilation and air-conditioning, Inżynier Budownictwa (Civil Engineer) 10 (2013) 62-64.
- [2] R. Cichowicz, G. Wielgosiński, A. Targaszewska, Analysis of CO<sub>2</sub> concentration distribution inside and outside small boiler plants, ECOL CHEM ENG S. 23 (1) (2016) 49-60, DOI: 10.1515/eces-2016-0003.
- [3] R. Cichowicz, G. Wielgosiński, Effect of meteorological conditions and building location on CO<sub>2</sub> concentration in the university campus, ECOL CHEM ENG S. 22 (4) (2015) 513-525, DOI: 10.1515/eces-2015-0030.
- [4] J. Szymańska, Podstawy wentylacji przemysłowej (Basics of industrial ventilation), Magazyn Przemysłowy (Industrial Magazine) 2016.

- [5] D. Węgrzyn, Powietrze dla przemysłu (Air for industry), *Magazyn Instalatora (Plumber Magazine)* 12 (2012) 12-14.
- [6] R. Rota, Industrial Ventilation, Ref. Mod. in Chem., Mol. Sc. and Chem. Eng. (2015), DOI: 10.1016/B978-0-12-409547-2.11223-5.
- [7] A. Mabbett, Industrial ventilation and air pollution control, *Metal Finishing* 105 (10) (2007) 678-698, DOI: 10.1016/S0026-0576(07)80385-0.
- [8] D. Węgrzyn, Wentylacja przemysłowa (Industrial Ventilation), *Magazyn Instalatora (Plumber Magazine)* 4 (2012) 16-17.
- [9] B. Biegert, J. Railio, Terminology, in: H. Goodfellow, E. Tahti (Eds.), *Industrial Ventilation. Design Guidebook*, Academic Press, 2001, pp. 9-14.
- [10] I. Sudoł-Szopińska, A. Chojnacka, Określanie warunków komfortu termicznego w pomieszczeniach za pomocą wskaźników PMV i PPD (Determining thermal comfort conditions in rooms with the PMV and PPD indices), *Bezpieczeństwo Pracy (Occupational Safety)* 5 (2007) 19-23.
- [11] ISO 7730:2005 Ergonomics of the thermal environment - Analytical determination and interpretation of thermal comfort using calculation of the PMV and PPD indices and local thermal comfort criteria.
- [12] G. Havenith, Heat balance when wearing protective clothing, *ANN OCCUP HYG* 43 (5) (1999) 289-296, DOI: 10.1016/S0003-4878(99)00051-4.
- [13] T. Fukazawa, G. Havenith, Differences in comfort perception in relation to local and whole body skin wittedness, *Eur. J. Appl. Physiol.* 106 (1) (2009) 15-24, DOI: 10.1007/s00421-009-0983-z.
- [14] ISO 7243:1989 Hot environments – Estimation of the heat stress on working man, based on the WGBT-index (wet bulb globe temperature).
- [15] N. M. Pinto, A. A. P. Xavier, K. Hatakeyama, Thermal comfort in industrial environment: conditions and parameters, *Procedia Manufacturing* 3 (2015) 4999 – 5006, DOI:10.1016/j.promfg.2015.07.662.
- [16] L. Lan, Z. Lian, Y.Liu, Investigation of gender difference in thermal comfort for Chinese people, *Eur. J. Appl. Physiol.* 102 (4) (2008) 471-480, DOI: 10.1007/s00421-007-0609-2.
- [17] D. Skrzyniowska, Parameters of indoor air in residential and non-residential buildings. *Thermal Comfort, Technical Transactions. Environmental Engineering* 4 (2012) 15-35.
- [18] A. Auliciems, S. V. Szokolay, Thermal comfort, PLEA in association with Dept. of Architecture, University of Queensland, 2007.
- [19] J. B. Joshi, Computational Fluid Dynamics for Designing Process Equipment: Expectations, Current Status and Path Forward, *Ind. Eng. Chem. Res.* 42 (6) (2003) 115-1128, DOI: 10.1021/ie0206608.
- [20] S. Yang, X. Li, C. Yang, B. Ma, Z. Mao, Computational Fluid Dynamics Simulation and Experimental Measurement of Gas and Solid Holdup Distribution in a Gas-Liquid-Solid Stirred Reactor, *Ind. Eng. Chem. Res.* 55 (12) (2016) 3276-3286, DOI: 10.1021/acs.iecr.5b03163.
- [21] K. S. Nikas, N. Nikolopoulos, A. Nikolopoulos, Numerical study of a naturally cross-ventilated building, *Energy and Buildings* 42 (4) (2010) 422-434, DOI: 10.1016/j.enbuild.2009.10.010.
- [22] Y. Ji, M.J. Cook, V. Hanby, CFD modelling of natural displacement ventilation in an enclosure connected to an atrium, *Building and Environment*, 42 (3) (2007) 1158-1172, DOI: 10.1016/j.buildenv.2005.11.002.
- [23] <http://www.openfoam.com>

- [24] <http://www.ansys.com/Products/Fluids/ANSYS-Fluent>
- [25] <http://www.thunderheadeng.com/pyrosim>
- [26] <https://www.designbuilder.co.uk>
- [27] A. Bohojło, M. Kołodziejczyk, Computational analysis of local thermal comfort factors in a habitable room, *Acta mechanica et automatic 3* (1) (2010) 14-23.
- [28] R. Cichowicz, A. Lewandowska, The analysis of selected parameters of thermal comfort in the classrooms using CFD techniques, *WSN 73* (1) (2017) 72-79.
- [29] M. Manickam, M. P. Schwarz, J. Perry, CFD modeling of waste heat recovery boiler, *Applied Mathematical Modelling 22* (10) (1998) 823-840, DOI: 10.1016/S0307-904X(98)10020-3.
- [30] H. Chen, Z. Liang, Damper opening optimization and performance of a co-firing boiler in a 300 MWe plant, *Applied Thermal Engineering 123* (2017), DOI: 10.1016/j.applthermaleng.2017.05.085.
- [31] R. Rota, L. Canossa, G. Nano, Ventilation design of industrial premises through CFD modeling, *CAN J CHEM ENG 79* (1) (2001), DOI: 10.1002/cjce.5450790112.
- [32] Technical CFD Documentation. DesignBuilder Software, <http://www.designbuilder.co.uk/downloads/CFDTechnical.pdf>
- [33] T. Hobler, Heat transfer and heat exchangers (Ruch ciepła i wymienniki), Państwowe Wydawnictwo Techniczne (National Technical Publishing), Warsaw, 1959
- [34] Microclimatic probes. User's manual, LSI LASTEM, [http://www.lsi-lastem.it/WebDocument/INSTUM\\_00499\\_it-en.pdf](http://www.lsi-lastem.it/WebDocument/INSTUM_00499_it-en.pdf)
- [35] Y. J. P. Lin, J. Y. Wu, A study on density stratification by mechanical extraction displacement ventilation, *INT J HEAT MASS TRAN 110* (2017) 447-459, DOI: 10.1016/j.ijheatmasstransfer.2017.03.053.
- [36] A. C. Caputo, P. M. Pelagagge, Upgrading mixed ventilation systems in industrial conditioning, *Applied Thermal Engineering 29* (14-15) (2009) 3204-3211, DOI: 10.1016/j.applthermaleng.2009.04.025.
- [37] S. Mierzwiński, Wentylacja Przemysłowa. Cz. I (Industrial Ventilation. Vol. I), Silesian University of Technology, Gliwice, 1979
- [38] B. Biegert, J. Railio, Industrial Air Technology - Description, in: Goodfellow H., Tahti E. (Eds.), *Industrial Ventilation. Design Guidebook*, Academic Press, 2001, pp. 1-7