

# AN EFFICIENCY NO ADAPTIVE BACKSTEPPING SPEED CONTROLLER BASED DIRECT TORQUE CONTROL

Submitted: 19<sup>th</sup> October 2016; accepted: 1<sup>st</sup> March 2017

*Abdelkader Ghezouani, Brahim Gasbaoui, Jamel Ghouili, Asma Amal Benayed*

DOI: 10.14313/JAMRIS\_1-2017/8

## Abstract:

*The most problem of direct torque control are high torque ripple and Settling time to overcome this problem an efficiency Backstepping speed controller are proposed. This paper makes a comparison of the effectiveness of three PI speed controller based direct torque control, the first one is the classical PI speed controller (CL-PISC), the second are no Adaptive Backstepping controller (NA-BACKSC), and the third type are adaptive fuzzy PI controller (AF-PISC). The parameters of adaptive fuzzy PI are dynamically adjusted with the assistance of fuzzy logic controller. The non-Adaptive Backstepping controller is designed based on the Lyapunov stability theorem. The direct torque control is very adapted for electric propulsion systems; we apply this new strategy for an 15 Kw induction motor. The proposed PI controllers are simulated in MATLAB SIMULINK environment. The simulation results confirmed that the NA-BACKSC, present robust and the best dynamic behavior on direct torque control compared to AF-PISC and CL-PISC.*

**Keywords:** backstepping, induction motor, DTC, PI controller, fuzzy controller

## 1. Introduction

Last twenty years the Induction motor is one of the most widely used actuator for industrial applications because of its reliability, ruggedness and relatively low cost. The control of induction motor system is challenging, since the dynamical system is multivariable, coupled, and highly nonlinear. Among the most appropriate commands to the electric propulsion system is the direct torque control.

Direct torque control (DTC) is a closed-loop control technique for induction machine, which implementation is based on hysteresis comparators. In this method, control variables are torque and stator flux of induction machine. This technique was initially proposed in [1, 2]. The main advantages of DTC are robust and fast torque response, no requirements for PWM pulse generation and current regulators, as well as good steady-state and dynamic performances. In this work the design of Backstepping to control a winding system is proposed in order to improve the performances of the control system, which are coupled mechanically, and synthesis of the robust control and application to synchronize and to maintain a constant

mechanical tension between the controllers of the system. The advantage of Backstepping control is its robustness and ability to handle the non-linear behavior of the system. The model of the winding system, and in particular the model of the mechanical coupling, are developed and presented in Section (2). Section (3) shows the direct field oriented control (FOC) of induction motor Section (4) shows the development of Backstepping technique control design. The Speed Control of Each induction machine by Backstepping controllers design is given in section (5). Simulation results using MATLAB SIMULINK of different studied cases is defined in Section (6). Finally, the conclusions are drawn in Section (7). In this work, a No Adaptive Backstepping controller was analysed and applied to the control of direct torque control of the asynchronous machine. Simulation tests showing a remarkable behavior of Non-Adaptive Backstepping controller in regulation and prosecution, a disturbance rejection significantly better than other regulators, very good performance and robustness.

## 2. Direct Torque Control Strategy

The basic DTC strategy is developed in 1986 by Takahashi [3]. It is based on the determination of instantaneous space vectors in each sampling period regarding desired flux and torque references. The block diagram of the original DTC strategy is shown in Figure 1. The reference speed is compared to the measured one. The obtained error is applied to the speed regulator PI whose output provides the reference torque. The estimated stator flux and torque are compared to the corresponding references. The errors are applied to the stator flux and torque hysteresis regulators, respectively. The outputs of the stator flux and torque regulators and the phase of the stator flux are applied to the space vector selection table block which generates the convenient combinations of the states (ON or OFF) of the inverter power switches. There are eight switching combinations, two of which correspond to zero voltage space vectors which are (000) and (111). The stator flux is controlled by a tow-level hysteresis regulator, where the logical function takes “+1” to increase and “-1” to decrease it. The electromagnetic torque is controlled by its hysteresis regulator, where the logical function gives not only the states “+1” and “-1” (increase/decrease), but also “0” to hold [4].

The estimation value of flux and its phase angle is calculated in expression 2, 3, 4 and 5, respectively.

$$\phi_{s\alpha} = \int_0^t (V_s - R_s i_{s\alpha}) dt \quad (2)$$

$$\phi_{s\beta} = \int_0^t (V_s - R_s i_{s\beta}) dt \quad (3)$$

$$\phi_s = \sqrt{\phi_{s\alpha}^2 + \phi_{s\beta}^2} \quad (4)$$

$$\theta_s = \text{artg} \left( \frac{\phi_{s\beta}}{\phi_{s\alpha}} \right) \quad (5)$$

Where:  $\phi_{s\alpha}$ ,  $\phi_{s\beta}$  are the  $\alpha$  and  $\beta$  axes stator Flux,  $\phi_s$  is the stator Flux,  $\theta_s$  is the phase angle.

And the torque is controlled by three-level hysteresis. Its estimation value is calculated in expression (7).

$$J \frac{d\Omega}{dt} = C_{em} + C_r + B\Omega \quad (6)$$

$$C_{em} = \frac{3}{2} p (\phi_{s\alpha} i_{s\beta} - \phi_{s\beta} i_{s\alpha}) \quad (7)$$

Where:  $C_{em}$  is the electromagnetic Torque,  $C_r$  is a Load Torque,  $\Omega$  is the phase rotor speed,  $J$ ,  $p$  and  $B$  are the inertia, number of pairs of pole and fractional coefficient.

### 3. Controller Design

#### 3.1. Adaptive Fuzzy PI Controller

Fuzzy controllers have been widely applied to industrial process. Especially, fuzzy controllers are effective techniques when either the mathematical

model of the system is nonlinear or not the mathematical model exists. In this paper, the fuzzy control system adjusts the parameter of the PI control by the fuzzy rule. Dependent on the state of the system, the adaptive PI realized is no more a linear regulator according to this principle. In most of these studies, the Fuzzy controller used to drive the PI is defined by the control by the fuzzy rule.

Dependent on the state of the system, the adaptive PI realized is no more a linear regulator according to this principle. In most of these studies, the Fuzzy controller used to drive the PI is defined by the authors from a series of experiments [7]–[8]. The expression of the PI is given in the Equation (8):

$$y(t) = K_p e(t) + \frac{1}{T_i} \int_0^t e(t) dt \quad (8)$$

$$e(t) = \Omega^*(t) - \Omega(t) \quad (9)$$

Where:  $y(t)$  is the output of the control,  $e(t)$  is the input of the control, reference  $\Omega^*(t)$  is the reference speed,  $K_p$  and  $T_i$  are the parameter of the scale and of the integrator. The correspondent discrete equation is:

$$y(k) = K_p e(k) + \frac{1}{T_i} \sum_{j=1}^k e(j) T \quad (10)$$

Where:  $y(k)$  is the output on the time of  $k$  the sampling,  $e(k)$  is the error on the time of  $k$  sampling,  $T$  is the cycle of the sampling, and

$$\Delta e(k) = e(k) - e(k-1) y(k). \quad (11)$$

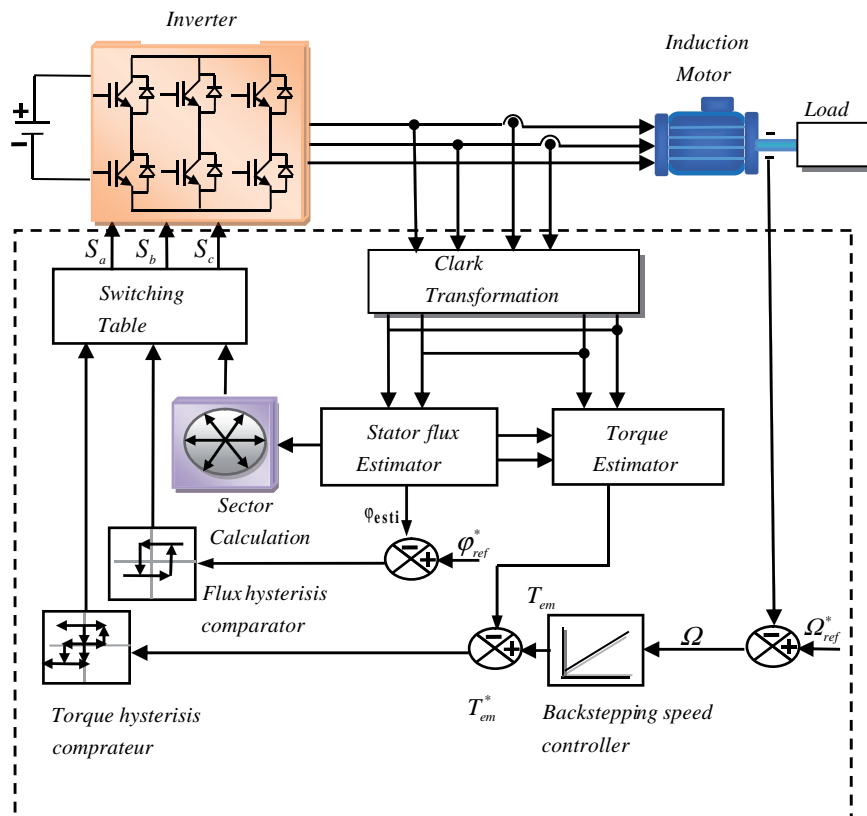

Fig. 1. Basic Direct Torque Control Scheme for AC Motor Drives

Simple transformations applied to equation (11) lead to:

$$y(t) = K_p e(t) + K_i \sum_{j=1}^k e(j) \quad (12)$$

### 3.2. Online Tuning

The online tuning equation for  $K_p$  and  $K_{pi}$  are show above:

$$K_p = \left[ (K_{pmax} - K_{pmin}) K'_p + K_{pmin} \right] \quad (13)$$

$$K_i = \left[ (K_{imax} - K_{imin}) K'_i + K_{imin} \right] \quad (14)$$

The frame of the fuzzy adaptive PI controller is illustrated in Figure 2.

The linguistic variables are defines as {N, ZE, P, B, M, S} meaning negative, zero error, positive, big, medium and small (tuning rules given in Table 1 and Table 2), and the membership function is illustrated in Figure 3 for gain  $K_p$  and Figure 5 for gain  $K_i$ .

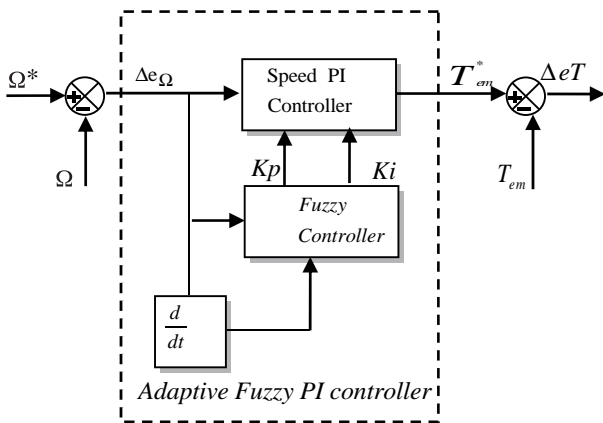

Fig. 2. PI gains online tuning by fuzzy logic controller

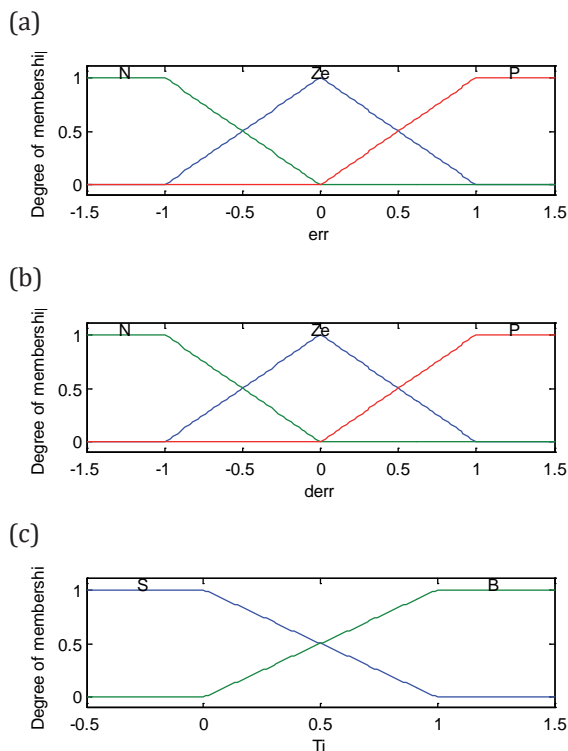

Fig. 3. Membership function for (a): error  $e(k)$ , (b) error derivative  $\Delta e(k)$ , (c) output  $K_p$

Table 1. Fuzzy tuning rules of  $K_p$

	$e(\Omega)$			
		N	ZE	P
$\Delta e(\Omega)$	N	B	S	B
	ZE	B	B	B
	P	B	S	B

Table 2. Fuzzy tuning rules of  $K_i$

	$e(\Omega)$			
		N	ZE	P
$\Delta e(\Omega)$	N	B	S	B
	ZE	B	M	B
	P	B	S	B

Using the settings given in Table (1 and 2) the fuzzy controllers were obtained and are given in Figure 4 and 6.

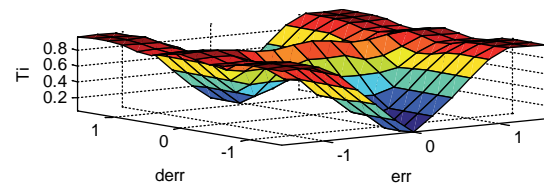

Fig. 4. View plot surface of fuzzy controller for  $K_p$

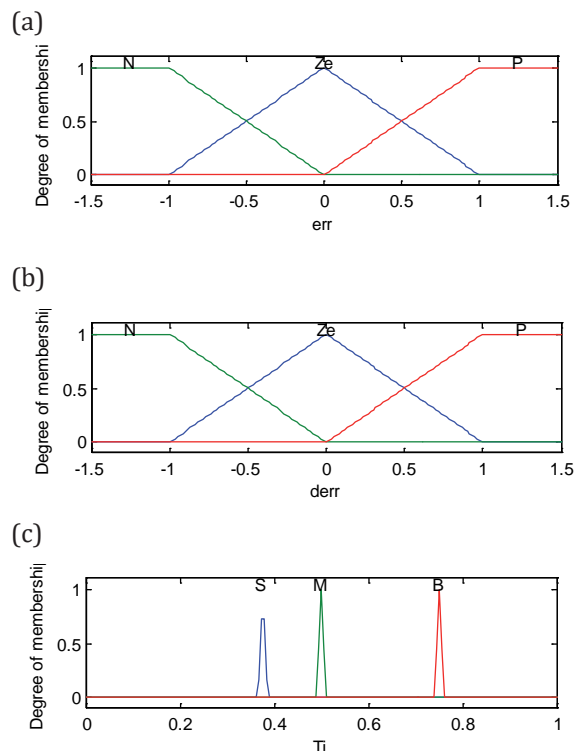

Fig. 5. Membership function, (a) error  $e(k)$ , (b) error derivative  $\Delta e(k)$ , (c) output  $K_i$

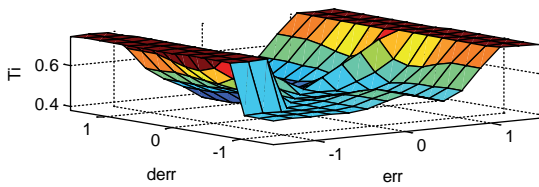

Fig. 6. View plot surface of fuzzy controller for  $K_i$

### 3.2. Backstepping Speed Controller

From equation (15), it is not difficult to drive:

$$\frac{d\Omega(t)}{dt} = \frac{1}{J}[C_{em}(t) + C_r(t) + B\Omega(t)] \quad (15)$$

where:

$$\frac{d\Omega(t)}{dt} = aC_{em}(t) + bC_r(t) + c\Omega(t) \quad (16)$$

Are constant parameters which are related to the motor parameters. The first step of the Backstepping control is defined log error of the state variable by the following calculation. The speed error:

$$e(t) = \Omega_{ref}(t) - \Omega(t) \quad (17)$$

Then the derivative of speed track error can be represented as:

$$\dot{e}(t) = \dot{\Omega}_{ref}(t) - \dot{\Omega}(t) \quad (18)$$

with:

$$\dot{\Omega}(t) = aC_{em}(t) + bC_r(t) + c\Omega(t) \quad (19)$$

Then:

$$\dot{e}(t) = \dot{\Omega}_{ref}(t) - aC_{em}(t) - bC_r(t) - c\Omega(t) \quad (20)$$

Subsequently we define the Lyapunov function of the form:

$$V(t) = \frac{1}{2}e^2(t) \quad (21)$$

Its derivative gives:

$$\dot{V}(t) = e(t)\dot{e}(t) = e(t)[\dot{\Omega}_{ref}(t) - aC_{em}(t) - bC_r(t) - c\Omega(t)] \quad (22)$$

In order to guarantee  $\dot{V} \leq 0$  we select the following control input:

$$C_{em}^*(t) = \frac{1}{a}(\dot{\Omega}_{ref}(t) - c\Omega(t) + Ke(t)) + C_r; K > 0 \quad (23)$$

By substng (22) into (23), we can obtain:

$$\dot{V}(t) = -Ke^2(t) \quad (24)$$

From equation (24), we can conclude that the system is stable. By integrating equation (24), we can obtain:

$$\int_0^\infty \dot{V}(\tau)d\tau = V(\infty) - V(0) < 0 \quad (25)$$

From equation (23) the integrating of parameter of the equation (24) is less than infinite.

Then,  $e(t) \in L_\infty \cap L_2$  and  $\dot{e}(t)$  is bounded. According to Barbalet Lemma [5-6], we can conclude

$$\lim_{t \rightarrow \infty} e(t) = 0 \quad (26)$$

The block diagram of the proposed non Adaptive Backstepping control system is shown in Figure 7.

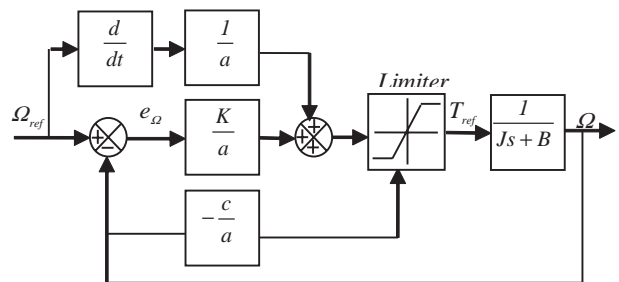

Fig. 7. The No adaptive Backstepping speed Controller

## 4. Simulation Results

The control scheme described in Figure 1 was tested by simulations and to evaluate the performance of the proposed structure, we have implemented on the Matlab / Simulink environment. To examine the performance and robustness of our controller we undergo our system to several test servers. The simulation results of the efficiency Non Adaptive Backstopping speed controller based DTC will be compared with adaptive Fuzzy PI speed controller and conventional PI speed control schema. The parameters of the induction motor used in the simulation are shown in Appendix.

### 4.1. Constant Speed Application

The simulation conditions are given as follows: the speed is 100 rd/s and the reference flux is 0.98 Wb; the initial load torque is 0 N m. According to the Figure 8., shown below, there is an excellent response time in setting time by NA-BACKSC (the speed reaches the reference value after  $t = 0.21$  s for the Backstepping controller and  $t = 0.35$  s for the other two types of controllers) which reduces the time of the transitional system, and improve the saving energy. You can also see a significant overshoot ( $D = 2.5\%$ ) for the CL-PISC. By against the Steady-state error converges to zero.

Figure 9. and Figure 10. shows the variation of electromagnetic torque and current, respectively.

### 4.2 Load Torque Application

To test the robustness of induction motor based DTC using three types of regulators, is to introduce a nominal load torque 35 Nm between  $t = 1$  s and 1.5 s.

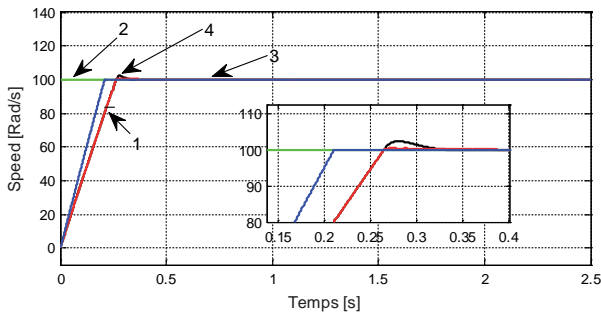

**Fig. 8. Speed response (rad/s). (1) AF-PISC, (2) Reference (3) CL-PISC, (4) NA-BACKSC**

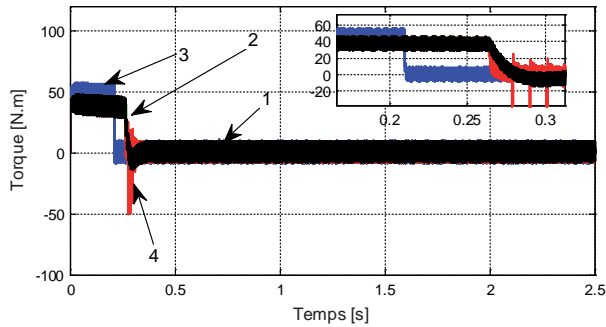

**Fig. 9. Electromagnetic torque response. (1) CL-PISC, (2) Reference, (3) NA-BACKSC, (4) AF-PISC**

According to Figure 11 the speed response stabilizes at the desired reference value and the same for the perturbation effect when applying the load torque it appears that a small decrease in speed (2.5 rad/s for a CL-PISC and 0.05 rad/s for NA-BACKSC).

The time necessary to eliminate the disturbance effect is faster with AF-PISC compared to the CL-PISC.

It is very interesting to show that NA-BACKSC are insensitive to this variation of the load torque. Figure 11, the stator current increased proportionally to that applied load torque. Figure 12, furthermore, the electromagnetic torque acts very quickly to follow the load torque and has introduced a remarkable reduction of harmonics in the case of CL-PISC and AF-PISC. Figure 13, and the introduction of perturbations is immediately rejected by the control system.

### 4.3 Inverse Rotation Speed

Figure 13 illustrates clearly the robustness of the proposed PI controller more particularly for speed of response a reverse of speed responses of the reference there of to 100 rad/s – 100 rad/s. The torque climbs to nearly 10 N m, when the motor starts and stabilizes rapidly when the motor reaches the reference value. Figure 15 and 16 shows the variation of current. It can be concluded that the proposed non adaptive Backstepping controllers are robust. The stator current present slight ripple for reversing the direction of rotation of the speed.

Figure 17 Shows that the flux of the DTC controller offers the fast transient responses that mean the trajectory of stator flux established more quickly than that of the Conventional Direct Torque Control. Figure 18 shown the stator flux trajectory for the different speed controller.

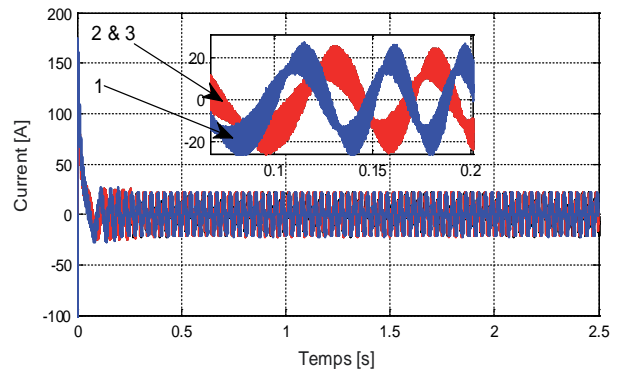

**Fig. 10. Current response. (1) NA-BACKSC, (2) CL-PISC, (3) AF-PISC**

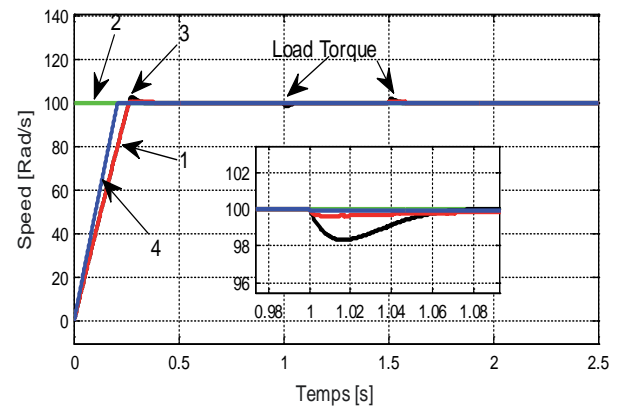

**Fig. 11. Speed response. (1) AF-PISC, (2) Reference, (3) CL-PISC, (4) NA-BACKSC**

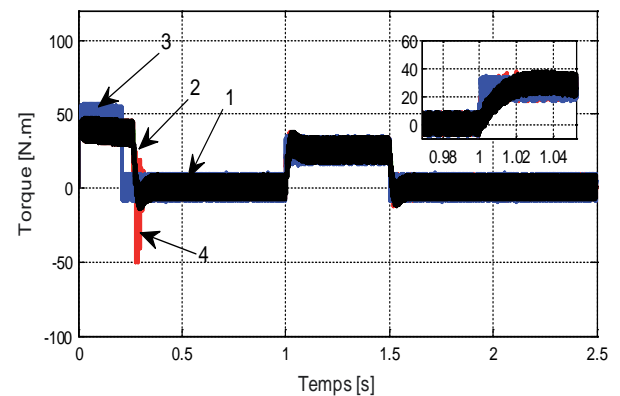

**Fig. 12. Electromagnetic torque response. (1) CL-PISC, (2) Reference, (3) AF-PISC, (4) NA-BACKSC**

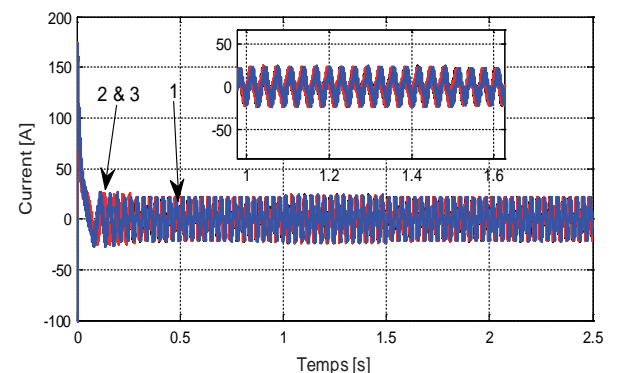

**Fig. 13. Current response. (1) NA-BACKSC, (2) CL-PISC, (3) AF-PISC**



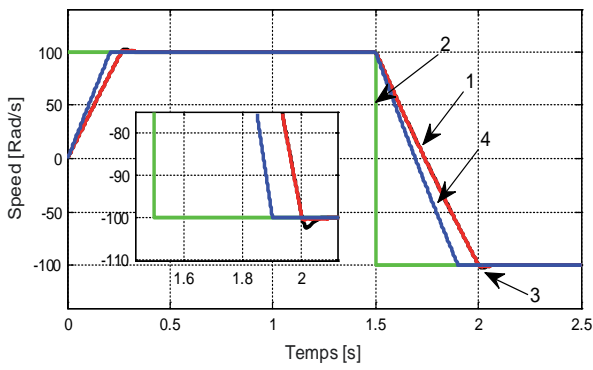

Fig. 15. Speed reponse. (1) AF-PISC, (2) Reference, (3) CL-PISC, (4) NA-BACKSC

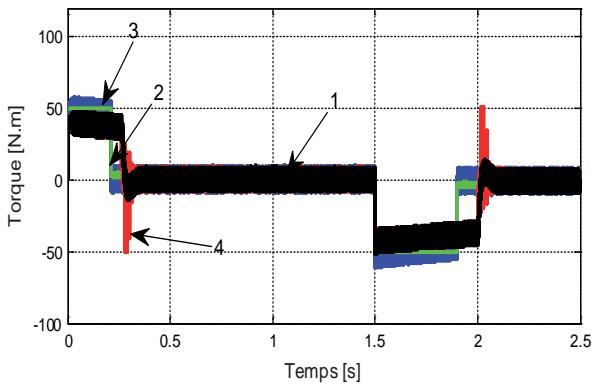

Fig. 16. Electromagnetic torque response. (1) CL-PISC, (2) Reference, (3) NA-BACKSC, (4) AF-PISC

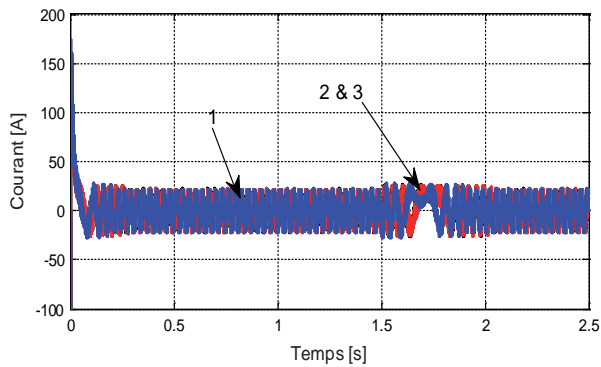

Fig. 17. Current response. (1) NA-BACKSC, (2) L-PISC, (3) AF-PISC

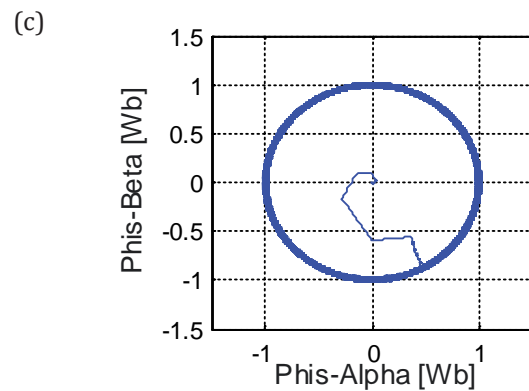
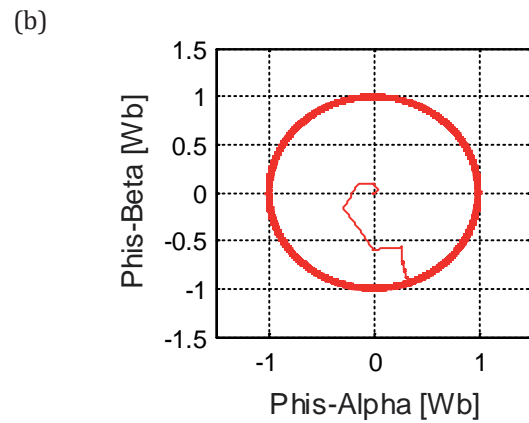
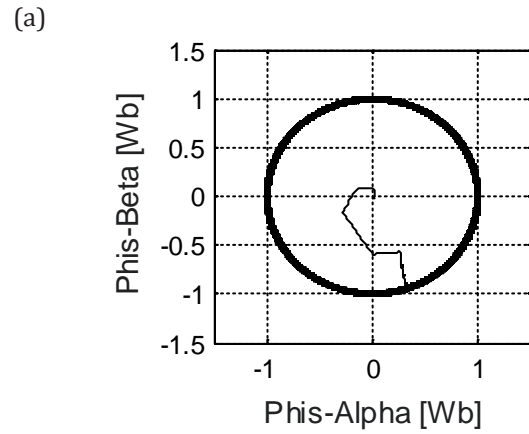

Fig. 18 The stator flux circle. (a) CL-PISC, (b) NA-BACKSC, (c) AF-PISC

Table 4. Comparison of simulation results

Performance Index	Controller Design		
	Classical PI Controller	Fuzzy PI adaptive Controller	No Adaptive Backstopping Controller
Rise time	0.264	0.263	0.209
Peak of Electromagnetic Torque [N.m]	47	47	57
Current amplitude [A]	122	122	172
Disturbance rejection Time [s]	0.22	0.5	No effect disruption
The time reverse speed [s]	0.5	0.5	0.4
Overshot [rad/s]	2.5	0.5	0
Design	Simple	Difficult	Simple

#### 4.4. Comparative study

Table 4 shows a comparison studies between the results obtained by direct torque control (DTC) shemas using classical PI controller, adaptive fuzzy PI controller and no adaptive backstepping PI speed controller. It is clearly that the no adaptive controller Backstepping offers better performances in both of the overshoot control and the tracking error and eliminate torque peaks. However, the adaptive Fuzzy PI controller remains average compared to non adaptatif Backstepping controller.

#### 5. Conclusion

The research outlined in this paper has demonstrated the feasibility of an effechny backstepping controller using direct torque control. The results obtained by simulation show that this structure permits the realization of the robust control based on Fuzzy inference system, with good dynamic and static performances for induction motor control. The proposed no adaptive Backstepping speed controller model improve the speed and torque reponses and gives a good rising time and no overshoot. From the foregoing results it's clear that the No adaptative Backstepping speed controller is effective for further instructions and disturbance rejection of the induction machine.

#### Appendix

##### Induction Motor Parameters

Parameter name	Symbol	Value	Unit
Rotor Inductance	$L_r$	0.0651	H
Stator Inductance	$L_s$	0.0651	H
Mutual Inductance	$L_m$	0.0641	⊗
Stator Resistance	$R_s$	0.2147	$\Omega$
Rotor Resistance	$R_r$	0.2205	$\Omega$
Number of Pole Pairs	$p$	2	
Motor-Load inertia	$J$	0.102	$\text{kg} \cdot \text{m}^2$
Rated Power	$P_N$	15	KW
Rated Voltage	$U$	380	Volt
Nominal Frequency	$f_N$	50	Hertz
Viscous Friction coefficient	$B$	0.009541	$\text{N} \cdot \text{ms}$

#### Acknowledgements

This work was supported by Laboratory of Smart Grids & Renewable Energies (S.G.RE). Faculty of technology, Department of Electrical Engineering, Bechar University, Algeria.

#### AUTHORS

**Abdelkader Ghezouani, Brahim Gasbaoui\*** and **Asma Amal Benayed** – Faculty of Sciences and Technology, Department of Electrical Engineering Bechar University B.P 417 BECHAR (08000), Algeria.  
E-mail: gasbaoui\_2009@yahoo.com.

**Gamel Ghouli** – Department of Electrical Engineering, Moncton University (Canada).

\*Corresponding author

#### REFERENCES

- [1] Baader U., Depenbrock M., Gierse G., "Direct Self Control (DSC) of Inverter Fed Induction Machine. A Basis for Speed Control without Speed Measurement", *IEEE Transaction on Industry Applications*, vol. 28, no. 3, May/June 1992, 581–588.
- [2] Kukrer O., "Discrete-time Current Control of Voltage-fed Three-phase PWM Inverter", *IEEE Transaction on Power Electronics*, vol. 11, no. 2, March 1996, 260–269.
- [3] Takahashi I., Noguchi T., "A New Quick-response and High Efficiency Control Strategy of an Induction Motor", *IEEE Transaction on Industrial Applications*, vol. IA-22, No. 5, Sept. 1986, 820–827.
- [4] Vasudevan M., Arumugam R., Paramasivam S., "High-performance Adaptive Intelligent Direct Torque Control Schemes for Induction Motor Drives", *Serbian Journal of Electrical Engineering*, vol. 2, No. 1, May 2005, 93–116.
- [5] Kristic M., Kanellakopoulos I., Kokotovic P. V., *Nonlinear and Adaptive Control Design*, New York: John Wiley and Sons Inc. 1995.
- [6] Tao, G., " *Adaptive Control Design and Analysis*", (New Jersey: Wiley-Interscience, 2003.
- [7] Gupta. A., Khambadkone. A. M., "A space vector pwm scheme for multilevel inverters based on two-level space vector pwm," *IEEE Transaction on Industrial Electronics*, vol. 53, October 2006.
- [8] Sun D., He Y., "Space vector modulated based constant switching frequency direct torque control for permanent magnet synchronous motor". In: *Proceedings of the CSEE*, vol. 25, no. 12, 2005, 112–116.