

35 mm ammunition's trajectory model identification based on firing tables

L. BARANOWSKI^{1*}, B. GADOMSKI², P. MAJEWSKI², and J. SZYMONIK²

¹Faculty of Mechatronics and Aerospace, Military University of Technology, ul. gen. Witolda Urbanowicza 2, 00-908 Warsaw, Poland

²PIT-RADWAR S.A., ul. Poligonowa 30, 04-051 Warsaw, Poland

Abstract. The article presents a procedure designed for identification of projectile's trajectory model through aerodynamic coefficients estimation. The identification process is based on firing tables artificially prepared (firing tables prepared using mathematical flight model for the projectile instead of trajectories recorded on field tests) with the use of modified point-mass and rigid body trajectory models. All the necessary data, including physical parameters of the projectile and its aerodynamic characteristics are provided. The detailed results of estimation of chosen aerodynamic coefficients are presented in both visual and tabular form. The main purpose of this paper is to establish the minimum number of trajectories (as characterized in firing tables), and the permissible error of initial parameters being passed to the mathematical model that would allow the correct identification of projectile's trajectory model.

Key words: identification, exterior ballistics, equations of projectile motion, curve fitting, drag coefficient.

1. Introduction

Modern fire control systems require the knowledge of precise but fast models of projectiles' motion. NATO standardization documents advise to use the modified point-mass trajectory model. The basic problem in developing such models is the ability to determine the coefficients of aerodynamic forces and moments that appear in the model. There are many methods for those coefficients estimation but the most accurate are indirect methods based on the measurement of the projectile flight parameters [1–9]. In [5] cubic splines with deficiency number 2 (cubic splines with continuous first derivatives [10]) are used in order to parametrize the drag coefficient curve. The quasi-Newton-Raphson method is then employed to solve multi-variable parametric minimization problem. In their research authors used the 3-DoF point-mass ballistic model. In [6] a high-order iterative learning identification method is proposed for extracting projectile's drag coefficient curve from radar measured velocity. Again the 3-DoF point-mass model is used in this paper. A different approach is presented in [2] which employs numerical solutions to the projectile's equations of motion. Linse and Stengel [1] propose to combine computational neural network models with an estimation-before-modeling paradigm for on-line training information. The method is used on simulated flight data of a twin-jet transport aircraft. A popular approach to the aerodynamic characteristics identification with the use of wind tunnel is presented in [9]. Author compares the free-flight data and wind tunnel results for the basic finner reference projectile. A different procedure of the system unknown

parameters estimation is proposed in [11, 12]. Authors use in both papers the D-optimality criterion which seeks to maximize the determinant information matrix (or equivalently minimize the determinant of the information matrix inverse).

Another approach to the identification process includes the analysis of firing tables containing quantities that describe a set of trajectories such as: quadrant elevation, range of the projectile, time of flight of the projectile, drift of the projectile (projectile motion in the horizontal plane), terminal velocity of the projectile (ground impact velocity), terminal altitude of the projectile (which does not appear in ground firing tables, only in anti-aircraft firing tables), prepared for a specific type of ammunition during field tests [13]. This paper focuses on the firing tables analysis method of projectile's trajectory model identification based on aerodynamic coefficients (used in the model) estimation. To be more precise, the mathematical model is identified by estimation of parameters of approximating functions (section 2.3) that describe aerodynamic coefficients in subsonic and supersonic regimes (this is meant further in the paper by the wording "aerodynamic coefficients estimation" unless stated otherwise) in terms of Mach number. In general, there are two types of firing tables: basic firing tables (prepared for standard atmospheric conditions [14]) and correction firing tables (contain the corrections for time of projectile's flight and quadrant elevation dependent on the deviations from standard atmospheric conditions). It is possible to describe the motion of projectile by one of three mathematical models that differ from each other mainly in the level of complexity, i.e., the point-mass trajectory model [15], the modified point-mass trajectory model [16, 17] and rigid body trajectory model (6DoF) [18, 19]. The latter is the model with 6 degrees of freedom that consists of 12 differential equations. It includes 13 different coefficients of aerodynamic forces and moments. The modified point-mass trajectory model has 4 degrees of freedom – three coordinates

*e-mail: leszek.baranowski@wat.edu.pl

Manuscript submitted 2017-09-30, revised 2018-01-10 and 2018-02-14, initially accepted for publication 2018-03-08, published in October 2018.

of the centre of mass and rotational speed. This model contains 6 coefficients of the forces and moments that affect the trajectory of the projectile in the highest degree. The model identification process is much less complicated due to decreased number of coefficients. In this article two of them are considered: the modified point-mass trajectory model (MPMTM) in its explicit form presented in [16] (implicit form of this model can be found in [17]) and rigid body trajectory model. The comparison of explicit and implicit form of the modified point mass trajectory model is presented in [20]. Both models require ammunition parameters and aerodynamic coefficients in order to produce the trajectory of projectile. In many cases we have firing tables on our disposal but we do not have a projectile motion model which is crucial in modern fire control systems. This paper focuses on analyzing the possibility of the MPMTM identification. The identification process will be described for target practice-tracer (TP-T) 35 mm, spin-stabilized ammunition (Fig. 1).

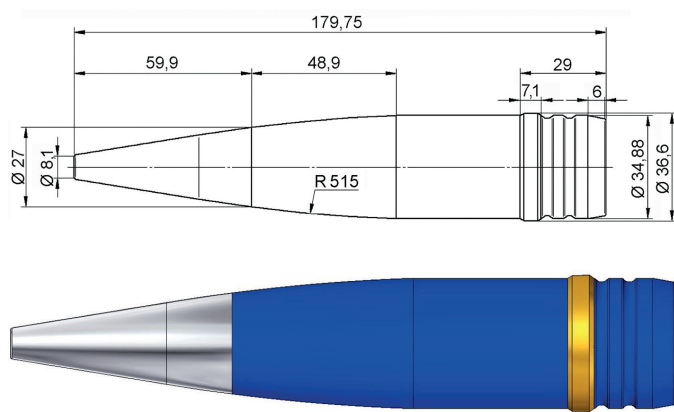

Fig. 1. Target-Practice Tracer 35 mm ammunition dimensions and 3D model

The goals of this paper are as follows:

- check whether the designed identification procedure is correct;
- find the minimal number of trajectories described by firing tables needed for correct identification of the mathematical model describing projectile's motion;
- establish the level of error of initial guess of aerodynamic coefficients values (in an iterative process), which will still enable the correct identification.

The process of model identification needs to be performed for each type of ammunition only once, i.e., if there are no changes in physical parameters (nominal) of the projectile.

2. Aerodynamic coefficients estimation procedure

This section will provide the procedure used for the aerodynamic coefficients estimation for TP-T ammunition. It is important to mention that firing tables for the particular type of

ammunition are prepared using trajectories recorded during field tests. Using data gathered for several projectile paths (projectiles shot with different quadrant elevation), mathematical flight model and identification methods it is possible to estimate aerodynamic coefficients that appear in the model. The next step is to produce, using the identified mathematical model, firing tables containing parameters that characterize the remaining (not recorded during field tests) trajectories.

However, one should keep in mind that field tests are expensive and the procedure of identification should be tested in all possible ways using computer simulations. In order to verify and validate the process of aerodynamic coefficients estimation, firing tables will be generated using two models of projectile trajectory: the explicit form of the modified point-mass trajectory model (MPMTM), and the rigid body trajectory model (6DoF). In the implicit form of the MPMTM the yaw of repose is determined using an iterative method, which makes the calculations more time consuming. The mathematical model contains the following equations [17]:

- dynamic differential motion equation of a projectile centre of mass

$$m\dot{\mathbf{u}} = \mathbf{DF} + \mathbf{LF} + \mathbf{MF} + \mathbf{DF} + m\mathbf{g}, \quad (1)$$

- dynamic equation of rotation around a projectile axis of a symmetry

$$\frac{d\mathbf{p}}{dt} = \frac{\pi\rho d^4 v C_{spin}}{8I_x} \mathbf{p}, \quad (2)$$

- equation of the yaw of repose vector

$$\alpha_e = \frac{8I_x p (\mathbf{v} \times \dot{\mathbf{u}})}{\pi\rho d^3 (C_{M_\alpha} + C_{M_{\alpha^3}} \alpha_e^2) v^4}, \quad (3)$$

where: \mathbf{DF} , \mathbf{LF} , \mathbf{MF} , \mathbf{g} are the drag, lift, Magnus force and gravitational acceleration vectors respectively. Forces acting on the projectile (including the planes in which they act) are described in details in [21]. Coriolis force is neglected, the gravity force is constant along the projectile's trajectory. The remaining letter symbols used in equations: d – projectile diameter (calibre), p – rotational speed, m – mass of the projectile, ρ – density of air, v – velocity of the projectile with respect to the air: $v = u - w$, u – velocity of the projectile with respect to the ground – fixed reference system, w – velocity of the wind, I_x – moment of inertia along the axis of the projectile, C_{spin} – spin damping coefficient, C_{M_α} – overturning moment coefficient, $C_{M_{\alpha^3}}$ – cubic overturning moment coefficient. It is worth mentioning that $C_{M_{\alpha^3}} = 0$ is assumed during the simulations (as a result of linear dependency of C_M on α). In such form, the vector α_e depends on $\dot{\mathbf{u}}$, which results in a differential equation being defined by an implicit function. The derived explicit form of the MPMTM is described by the following equations:

$$\dot{\mathbf{x}} = \mathbf{v} + \mathbf{w}, \quad (4)$$

where \mathbf{x} is the three-dimensional position vector,

$$\dot{p} = \frac{\rho v^2}{2I_x} S d C_{spin} \cdot \hat{p}, \quad S = \frac{\pi d^2}{4}, \quad (5)$$

$$\dot{v} = \frac{\rho v^2}{2m} S \left(C_{D0} + \hat{C}_{D\alpha^2} \left(\frac{2mg}{\rho v^2 S} \right)^2 \right) \frac{\hat{I}_x \hat{p}^2 \cos^2(\gamma_a)}{(1 - \hat{I}_x \hat{p}^2 \hat{C}_{mag-f})^2 + (\hat{I}_x \hat{p}^2 \hat{C}_{L\alpha})^2} - g \sin(\gamma_a) \quad (6)$$

and¹

$$\begin{bmatrix} \dot{\gamma}_a \\ \dot{\chi}_a \cos(\gamma_a) \end{bmatrix} = -\frac{g}{v} \frac{\cos(\gamma_a)}{(1 - \hat{I}_x \hat{p}^2 \hat{C}_{mag-f})^2 + (\hat{I}_x \hat{p}^2 \hat{C}_{L\alpha})^2} \begin{bmatrix} 1 - \hat{I}_x \hat{p}^2 \hat{C}_{mag-f} \\ \hat{I}_x \hat{p}^2 \hat{C}_{L\alpha} \end{bmatrix}. \quad (7)$$

Dimensionless coefficients used in equations:

$$\hat{I}_x = \frac{I_x}{md^2}, \quad \hat{p} = \frac{pd}{v}. \quad (8)$$

The above equations describe the case where the wind is homogeneous within the interval of integration, i.e. $\dot{\mathbf{w}} = 0$. The dimensionless coefficients were given as:

$$\hat{C}_{D\alpha^2} = \frac{C_{D\alpha^2}}{(C_{M\alpha})^2}, \quad \hat{C}_{L\alpha} = \frac{C_{L\alpha}}{C_{M\alpha}}, \quad \hat{C}_{mag-f} = \frac{C_{mag-f}}{C_{M\alpha}}. \quad (9)$$

Letter symbols used in the above equations: C_{D0} – aerodynamic drag force coefficient, $C_{D\alpha^2}$ – yaw drag coefficient, $C_{L\alpha}$ – lift force coefficient. Let us recall that from [20] it follows that the explicit and implicit forms of the MPMTM are equivalent. The estimation of the dimensionless coefficients described by (9) is described next.

In our simulations we will not use firing tables produced during field shootings. Such approach ensures that we know the aerodynamic coefficients to be estimated beforehand, and therefore we can assess whether the outcome of the model identification procedure is correct. Both models require ammunition parameters and aerodynamic coefficients, which will be provided. Only ground firing tables will be generated. The reader can easily produce such firing tables using aerodynamic coefficients that can be found in the paper [22], interpolation techniques (as described in chapter 2.3) and one of the mathematical models. Figure 2 presents the flowchart that describes the model identification process which will be described in the following subsections.

2.1. Firing tables and physical parameters of the projectile. In order to generate firing tables for TP–T ammunition we used aerodynamic coefficients produced by PRODAS

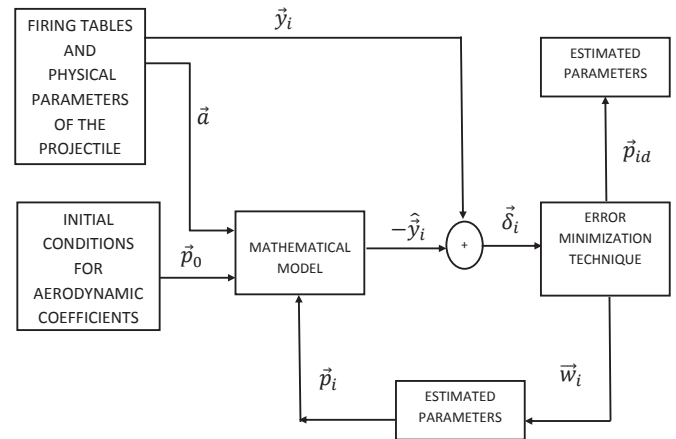

Fig. 2. Aerodynamic coefficients estimation procedure; \vec{y}_i – vector containing trajectory description from the firing tables (i.e. range, terminal velocity, vertex height, drift), \vec{y}_i – vector containing trajectory description calculated according to the mathematical model, \vec{a} – physical parameters of the projectile and characteristic quantities from firing tables (initial velocity, elevation angle, mass, diameter, axial moment of inertia), \vec{w}_i – vector containing coefficients, \vec{p}_0 – vector of the initial coefficients of the approximating functions, \vec{p}_i – vector of the approximating functions coefficients to be estimated, \vec{p}_{id} – vector of the estimated approximating functions coefficients

(Projectile Rocket Ordnance Design and Analysis System)² software. Data used in simulations is prepared with the use of both MPMTM and 6DoF. A firing table contains the following information about the projectile trajectory: range, quadrant elevation, time of flight, abscissa of the trajectory vertex, ordinate of the trajectory vertex, terminal velocity of the projectile and drift. Ground firing tables were generated for the elevation angle range of 50 to 710 mils³, the latter being the angle of maximum range. Authors use mils instead of degrees or radians as such convention is mostly used in artillery (which is the main field of the authors). During the preparation of firing tables it is crucial to remember that, in order to estimate aerodynamic coefficients in the broader range of Mach number, one needs to ‘shoot’ with elevation angles which would allow to measure projectile velocities in a much wider range. The ammunition physical parameters are presented in Table 1.

Table 1
Physical parameters for TP–T ammunition

Ammunition type	TP–T
Mass (projectile with fuse) [kg]	0.55
Initial velocity [m/s]	1180
Axial moment of inertia [kg·m ²]	0.977354e-4
Transversal moment of inertia [kg·m ²]	0.846886e-3
Diameter [m]	0.035

¹ γ_a is the elevation angle of \mathbf{v} measured from the horizontal direction, i.e. the air-path inclination angle and χ_a is the azimuth angle of \mathbf{v} , i.e. the air-path azimuth angle.

² www.prodas.com

³ 6400 mil = 2π rad

The initial angular velocity of the spinning motion was calculated using:

$$p = \frac{2\pi v}{27.57d}, \quad (10)$$

where the number 27.57 reflects the length of the revolution of the rifling in caliber units.

2.2. Error minimization technique. The MPMTM model is used for both the aerodynamic coefficients estimation and the firing tables generation, whereas 6DoF motion model is used only for firing tables generation. As it was mentioned, the rigid body's trajectory model contains a large number of aerodynamic coefficients which have a little impact on the simulated trajectory. Therefore it makes the process of model identification almost impossible to conduct.

Using firing tables generated as described in 2.1 the goal is to find the minimum number of trajectories required for correct identification of the projectile's trajectory model (for the specified initial errors of the identification process). The model identification procedure is an iterative process that runs as follows (relations between aerodynamic coefficients and the quantities used for model identification process can be found in [21]):

- estimation of the zero-yaw drag coefficient C_{D_0} based on the range and terminal velocity fitting;
- estimation of the lift force coefficient \hat{C}_{L_α} based on the projectile's drift;
- estimation of the Magnus force coefficient \hat{C}_{mag-f} based on the projectile's vertex height;
- estimation of the quadratic drag coefficient $\hat{C}_{D_{\alpha^2}}$ based on the range and terminal velocity.

To find a sensible local minimum in the multi-dimensional parameter space one needs to start to optimize only the most potent, i.e. highest order, forces and work ones way down. This way, the algorithm is gradually 'hinted' toward the area of interest in the parameter space. The consecutive algorithm's steps are as follows:

1. Estimate C_{D_0} by fitting the range and terminal velocity.
2. Estimate \hat{C}_{L_α} by fitting the projectile's drift.
3. Estimate \hat{C}_{mag-f} by fitting the vertex height.
4. Estimate $\hat{C}_{D_{\alpha^2}}$ by fitting the range and terminal velocity.
5. Check the level of relative error change δ_{Err} (relative error defined by (12)). If δ_{Err} is greater than the established value go to the step 1. Otherwise end the identification algorithm.

At this point we will provide the description of model errors for identification process. The critical problem is to properly define the relative error for the above quantities. As a physically correct assumption we adopted the distance traveled by the bullet as a relative measure. In order to obtain the distance, we need to add the differential equation

$$\dot{s} = v, \quad (11)$$

where v – velocity of the projectile and s – traveled distance (length of the flight path) with the initial condition $s(0) = 0$ meters. Therefore, the relative errors for the projectile's range,

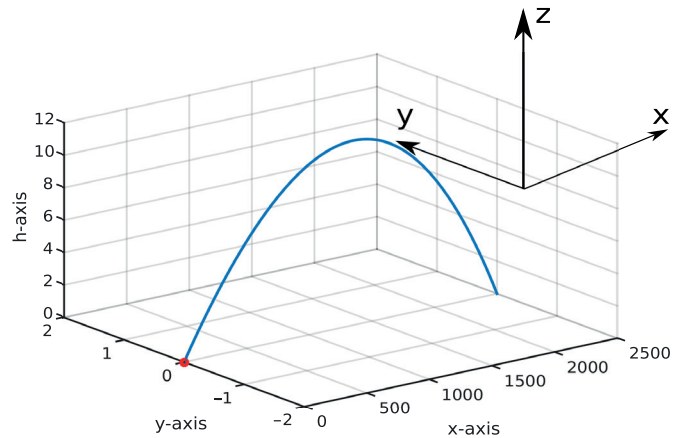

Fig. 3. Coordinate system used in calculations

drift, terminal height and terminal velocity respectively are as follows:

$$\delta_x = \frac{x - x_m}{s(T)}, \quad \delta_y = \frac{y - y_m}{s(T)}, \quad (12a)$$

$$\delta_h = \frac{h - h_m}{s(T)}, \quad \delta_v = \frac{(v - v_m)T}{2s(T)}, \quad (12b)$$

where δ_x – relative range error, x – range given by firing tables (coordinate system with trajectory example is presented in figure), $s(T)$ – distance which the projectile traveled during the time of flight given in firing tables, δ_y – relative drift error, y – drift correction given by firing tables (angle value in radian converted to meters), δ_h – relative error of the projectile terminal altitude, h – terminal altitude given by firing tables, δ_v – relative error of the projectile terminal velocity, v – terminal velocity given by firing tables, x_m, y_m, h_m, v_m – range, drift, vertex height (terminal height for anti-aircraft firing tables), terminal velocity obtained using mathematical model of the projectile flight. The stopping condition for the integration of equations of motion was dependent on the time of flight that was taken from firing tables. The main part of the identification process (Fig. 2) is the method for error minimization. The established criterion was to minimize the mean squared errors from the entire range of firing tables. For the minimization procedure we used MATLAB function *lsqnonlin* (trust-region-reflective algorithm [23, 24] which is used by default), which enables solving non-linear least-squares curve fitting problems.

2.3. Initial model parameters – aerodynamic coefficients interpolation. As it was mentioned before, our simulation tests are based on the values of aerodynamic coefficients for TP-T ammunition obtained from PRODAS software. Values of coefficients are included in the paper [22]. The identification process, as it was pointed out in section 2.2, will be conducted for drag, lift, and Magnus force coefficients. The first two coefficients will be interpolated using polynomials in certain variables r, s , which further on we shall call aerodynamic coefficient approximating functions of the form introduced in [25, 26]:

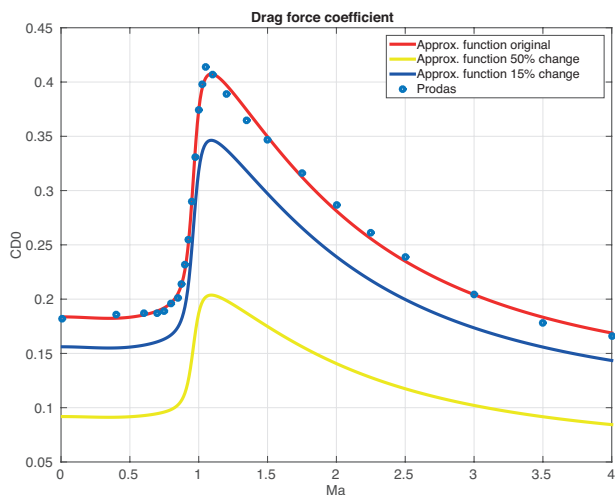

Fig. 4. Drag force coefficient (C_{D_0}) as a function of Mach number (Ma): values from PRODAS software and approximating functions

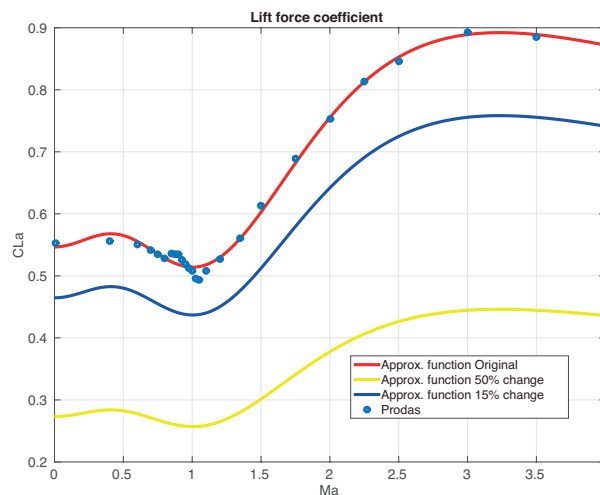

Fig. 5. Lift force coefficient (\hat{C}_{L_a}) as a function of Mach number (Ma): values from PRODAS software and approximating functions

$$C(\text{Ma}) = (1 + s)A(r) + (1 - s)B(r), \quad (13)$$

where:

$$A(r) = a_0 + a_1r + a_2r^2, \quad B(r) = b_0 + b_1r + b_2r^2, \quad (14)$$

$$r = \frac{(\text{Ma}^2 - K)}{(\text{Ma}^2 + K)}, \quad (15)$$

$$s = \frac{(\text{Ma}^2 - K)/(\text{Ma}^2 + K)}{\sqrt{(1 - L^2)r^2 + L^2}},$$

where $C(\text{Ma})$ is an aerodynamic coefficient dependent on the Mach number and $a_0, a_1, a_2, b_0, b_1, b_2, K, L$ are parameters to be fit. The approximating functions allow to model aerodynamic coefficients in both subsonic and supersonic regimes. Quadratic drag force coefficient (\hat{C}_{D_a}) and Magnus (\hat{C}_{mag-f}) force coefficient are assumed to be constant values. Such simplification of the model to be identified does not have significant impact on the identification procedure. In the paper, due to space limitations only identification results for the C_{D_0} and \hat{C}_{L_a} will be shown. Figure 4 shows values of the coefficient (as a function of Mach number) produced by PRODAS software and their approximating functions. PRODAS software uses physical parameters of the projectile in order to produce aerodynamic

coefficients even for projectiles that are not in its database. According to the documentation the percentage error for some coefficients are: 3% – 5% for axial force; 6% – 10% for normal force; 33% for Magnus force. For the simulation tests authors used aerodynamic coefficients that differed from original ones by 15% and 50% – functions approximating these coefficients are shown in Figs. 4 and 5. The approximating functions of the original aerodynamic coefficient values are only used during the phase of firing tables generation. The other functions are used as initial parameters for the identification process – obviously there is no point of conducting the identification procedure with correct initial values of the parameters to be estimated. Details on using all forms of approximating functions are given in the next section. According to PRODAS documentation the level of error for initial aerodynamic coefficients values is assumed to be higher (than it is predicted by the PRODAS software documentation) for the forces with the greatest impact – drag and lift forces.

One should remember, that when using coefficients from [22], the lift, Magnus and quadratic drag force coefficient is in the form suitable for the MPMTM model in its implicit form. For aerodynamic drag and lift force coefficients interpolation we used the MATLAB function *lsqcurvefit* to fit the approximating function (13). Table 2 contains values of the estimated approxi-

Table 2

Coefficients of approximating functions of the aerodynamic drag and lift force coefficients; DFC0, DFC15, DFC50 – approximating functions for original data and for values changed by 15% and 50% respectively for drag force coefficient; LFC0, LFC15, LFC50 – approximating functions for original data and for values changed by 15% and 50% respectively for lift force coefficient

	a_0	a_1	a_2	b_0	b_1	b_2	K	L
DFC0	0.219726	-0.068226	-0.0941	0.097469	0.017261	0.011623	0.929411	-0.064276
DFC50	0.109864	-0.034116	-0.047070	0.048734	0.008629	0.005810	0.929413	-0.064279
DFC15	0.186769	-0.057999	-0.080018	0.082848	0.014669	0.009878	0.929413	-0.064279
LFC0	33.066817	-348.791715	316.035554	-32.473851	283.739894	316.487091	2.153751	1.000840
LFC50	34.651945	-352.218964	317.722399	-34.355475	283.457267	317.949416	2.153499	1.000418
LFC15	34.170478	-350.928496	317.022103	-33.666464	283.508562	317.407370	2.153673	1.000712

imating functions coefficients for both original and altered aerodynamic coefficients values. The reader should keep in mind that Table 2 contains the coefficients of the approximating functions and not the values of aerodynamic coefficients themselves. In order to obtain the coefficients from the table, one should use the already mentioned MATLAB function *lsqcurvefit* and approximating function (13). While generating firing tables with the use of 6DoF model authors interpolated the values of all other aerodynamic coefficients using gridded data piecewise cubic Hermite interpolation (MATLAB *griddedInterpolant* class).

3. Results of identification process for TP–T 35 mm ammunition

In our simulations we focused on establishing the minimum number of trajectories characterized as in firing tables, and the maximum level of error of initial parameters being passed to the mathematical model that would allow its correct identification. The analysis of the identification process is based on the firing tables generated by both MPMTM and 6DoF model (the former is also used during parameters estimation). The procedure that we have followed during simulations is described in subsection 2.2.

3.1. Identification based on the firing tables generated with the modified point–mass trajectory model. In the first phase of our analysis we focused on verifying our algorithm for model identification. Therefore, we used MPMTM model for both identification and firing tables generation. After conducting a set of computer simulations we established the level of error of initial values of approximating functions' coefficients (section 2.3) on 50% (Figs. 4 and 5). The minimum number of trajectories characterized in firing tables is 7 (trajectories were chosen from the range 50–650 mils with the interval of 100 mils) when using MPMTM model. Figures 6 and 7 show

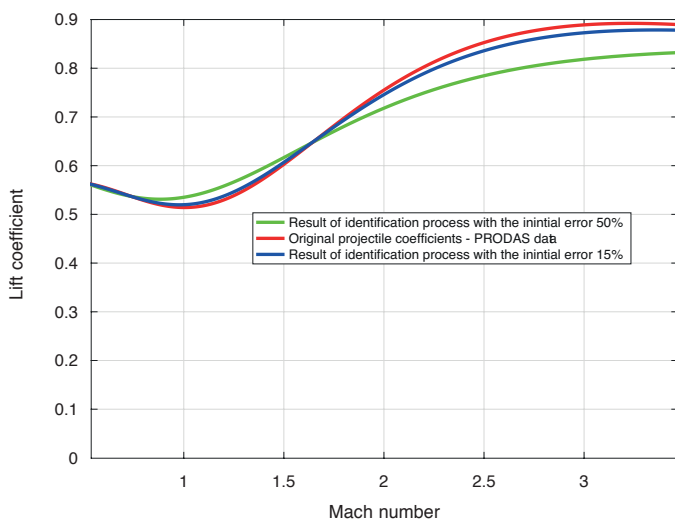

Fig. 6. Lift force coefficient: values from PRODAS software and approximating functions – result of the identification process for different starting values

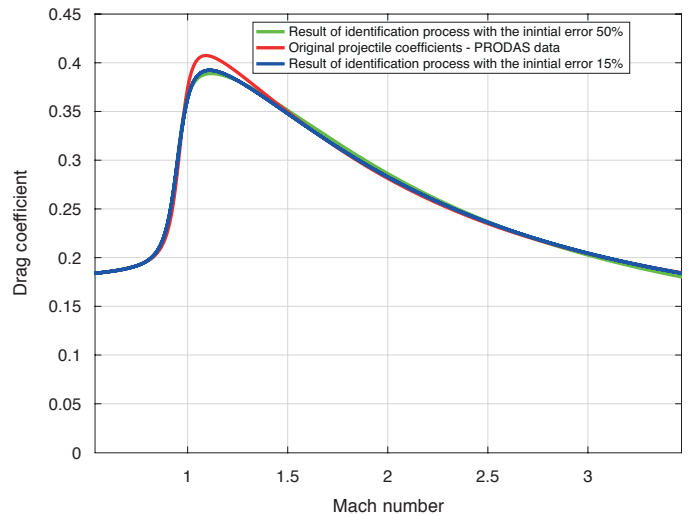

Fig. 7. Drag force coefficient: values from PRODAS software and approximating functions – result of the identification process for different starting values

the results of drag and lift force coefficients compared to the original data generated by PRODAS. The identification procedure was stopped when all of the relative errors (refers to the quantities from firing tables) reached the level below 0.01% – as it can be seen on Fig. 8. Therefore, considering our anal-

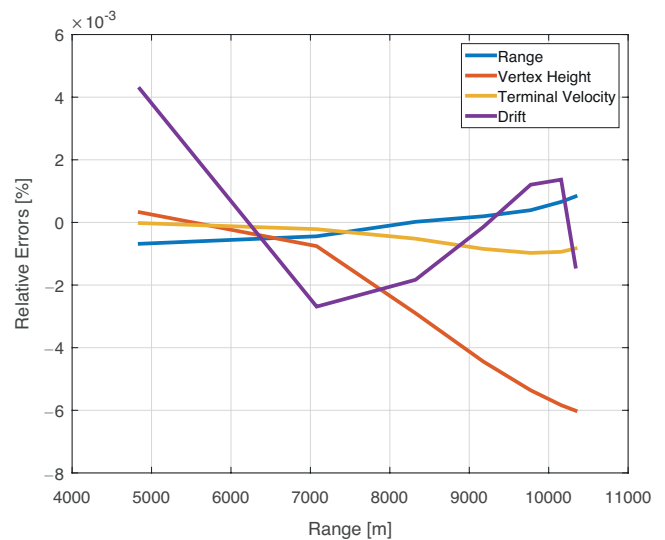

Fig. 8. Relative errors (as defined by (12)) for range, vertex height, terminal velocity and drift – the result of identification process for 35 mm TP–T ammunition

ysis' results, we can claim that the identification process is valid – we managed to estimate aerodynamic coefficients with the acceptable tolerance. Figure 9 shows the absolute errors obtained for the estimated aerodynamic coefficients. The most significant error is associated with the terminal height – however it is crucial to notice that error value is still lower than 80 cm

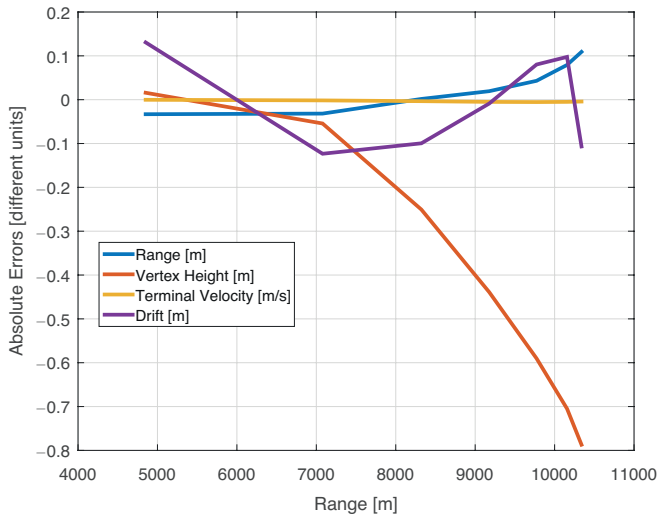

Fig. 9. Absolute errors for range, vertex height, terminal velocity and drift – the result of identification process for 35 mm TP–T ammunition. Units for each quantity is given in the legend

for the longest trajectory (range over 10 km). The maximum error values for the drift and range are around 10 cm each and the terminal velocity error is below 0.6 cm/s.

3.2. Identification based on the firing tables generated with the 6DoF model. In the following simulation tests we established the level of error of initial parameters to be equal to 15% (50% error made the identification process impossible to conduct) and the minimum number of trajectories (9 trajectories chosen from the range of 50–450 mils with the interval of 50 mils) based on firing tables generated with the use of 6DoF (MPMTM still used in the identification process). These values guarantee that the identification procedure will give us satisfying outcomes – relative errors level below 0.06% (Fig. 12). Figures 10 and 11 show the results of the model identification process for lift and drag force coefficients. It can be seen that despite the relatively small differences between estimated and original coefficients, minimum relative errors are higher when

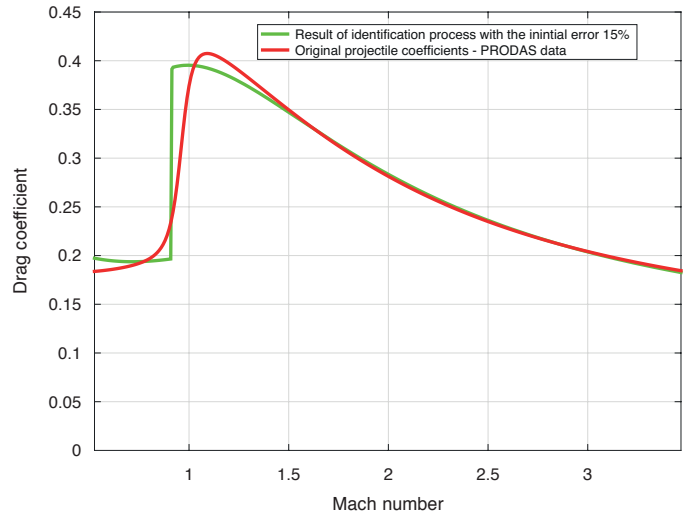

Fig. 11. Drag force coefficient: values from PRODAS software and approximating functions

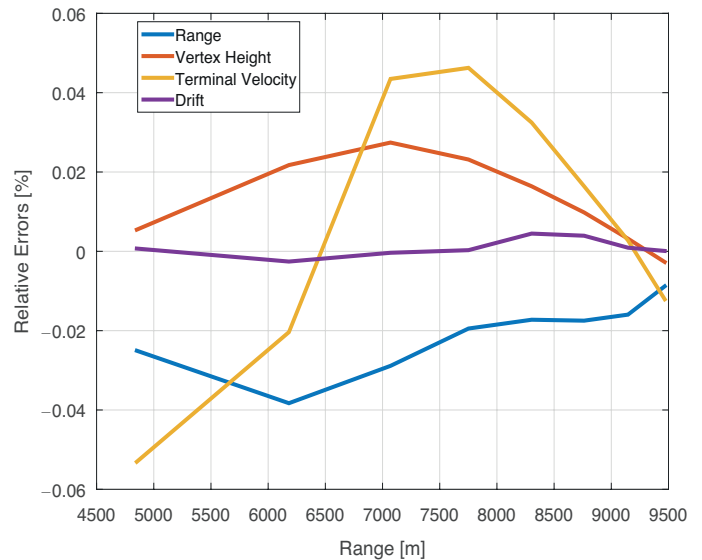

Fig. 12. Relative errors (as defined by (12)) for range, vertex height, terminal velocity and drift – the result of identification process for 35 mm TP–T ammunition

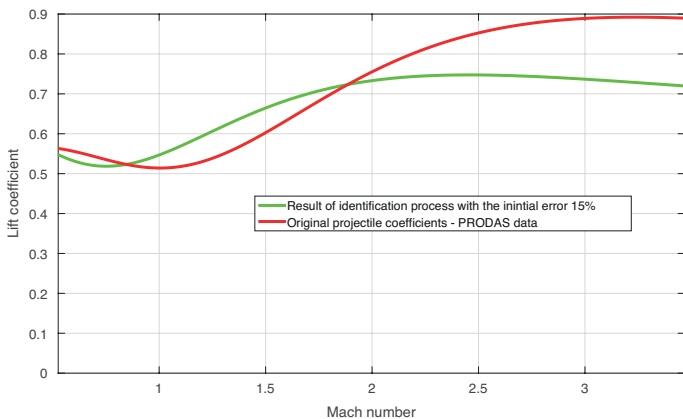

Fig. 10. Lift force coefficient: values from PRODAS software and approximating functions

using firing tables generated with the use of 6DoF than with the modified point–mass model. One should keep in mind that the equations of motion of the projectile treated as a rigid body take into account higher number of physical processes that can affect the bullet during the flight. It is therefore natural that the results are slightly worse when using in the identification process the MPMTM – model where we focus only on four (out of 11) aerodynamic coefficients that are used in 6DoF. Figure 13 shows the absolute errors obtained for the identified model. The highest error values are associated with the terminal altitude and range of the projectile – errors are within the absolute value of 2.5 meters. The terminal velocity error is within the absolute value of approximately 0.5 m/s.

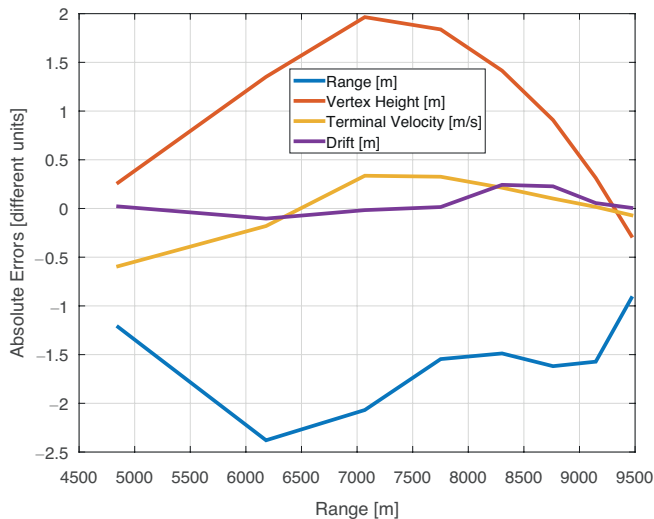

Fig. 13. Absolute errors for range, vertex height, terminal velocity and drift – the result of identification process for 35 mm TP-T ammunition. Units for each quantity is given in the legend

4. Conclusions

During our simulations we studied the possibility of parametric identification of the modified point-mass trajectory model (recommended by NATO standardization documents) in its explicit form for the purposes of Fire Control Systems. The firing tables generated with the modified point-mass model and 6DoF model were used in the identification process. In both cases the outcome of the identification process was correct. It was found that when using the data obtained from 6DoF model, the initial values of aerodynamic coefficients have to be more precisely determined (determined with lower value of initial error). We also established the minimum number of trajectories described by firing tables needed for correct identification. Such analysis is vital for the accurate planning of field tests with the use of artillery. Computer simulations give better insight into the issues related to determining the number of different elevation angles for artillery shooting.

Acknowledgements. This paper was created as part of the development project No. O ROB 0046 03 001 that is financed by the Polish National Center for Research and Development in the period between 2012 and 2016.

REFERENCES

[1] D.J. Linse and R.F. Stengel, "Identification of Aerodynamic coefficients Using Computational Neural Networks", *Journal of Guidance, Control, and Dynamics* 16 (6), 1018–1025 (1993).
 [2] G.T. Chapman and D.B. Kirk, "A method for extracting aerodynamic coefficients from free flight data", *AIAA Journal* 8 (4), 753–758 (1970).
 [3] L.C. Anderson and J.H. Vincent, "Application of system identification to aircraft flight test data", *Proceedings of the 24th IEEE Conference on Decision and Control*, 1929–1931 (1985).

[4] R.F. Lieske and A.M. Mackenzie, Determination of aerodynamic drag from radar data, Aberdeen Proving Ground Technical Report 22010, (1972).
 [5] Y. Chen, C. Wen, H. Dou, and M. Sun, "Iterative learning identification of aerodynamic drag curve from tracking radar measurements", *Control Eng. Practice* 5 (11), 1543–1553 (1997).
 [6] Y. Chen, C. Wen, J. Xu, and M. Sun, "Drag coefficient curve identification of projectiles from flight tests via optimal dynamic fitting", *Control Eng. Practice* 5 (5), 627–636 (1997).
 [7] Y. Chen, C. Wen, Z. Gong, and M. Sun, "High-Order Iterative Identification of Projectile's Aerodynamic Drag Coefficient Curve from Radar Measured Velocity Data", *IEEE Transactions on Control Systems Technology* 6 (4), 563–570 (1998).
 [8] G.G. Dutta, A. Singhal, A. Kushari, and A.K. Ghosh, "Estimation of Drag Coefficient from Radar-tracked Flight Data of a Cargo Shell", *Defence Science Journal* 58 (3), 377–389 (2008).
 [9] A. Dupuis: Aeroballistic range and wind tunnel tests of the Basic Finner reference projectile from subsonic to high supersonic velocities, Technical report, Defence Research Establishment, Valcartier, Quebec, 2002.
 [10] J.L. Walsh, J.H. Ahlberg, and E.N. Nilson, *The Theory of Splines and Their Applications: Mathematics in Science and Engineering*, Vol. 38, Academic Press, New York/London, 1967.
 [11] Z. Koruba and I. Krzysztofik, "An algorithm for selecting optimal controls to determine the estimators of the coefficients of a mathematical model for the dynamics of a self-propelled anti-aircraft missile system", *Proceedings of the Institution of Mechanical Engineers, Part K: Journal of Multi-body Dynamics* 227 (1), 12–16 (2013).
 [12] P. Lichota, "Inclusion of the D-Optimality in multisine maneuver design for aircraft parameters estimation", *J. Theor. Appl. Mech.* 54 (1), 87–98 (2016).
 [13] L. Baranowski and M.A. Kojdecki, "Inverse problem of external ballistics and algorithm for determining parameters of artillery projectile motion models", *Biuletyn Wojskowej Akademii Technicznej*, 56 (4), 167–186 (2007) (in Polish).
 [14] U.S. Standard Atmosphere, United States Air Force, Washington, D.C., October 1976.
 [15] K. Motyl, M. Magier, J. Borkowski, and B. Zygmunt, "Theoretical and experimental research of anti-tank kinetic penetrator ballistics", *Bull. Pol. Ac.: Tech.* 65 (3), 399–404 (2017).
 [16] L. Baranowski, B. Gadomski, P. Majewski, and J. Szymonik, "Explicit "ballistic M-model": a refinement of the implicit "modified point mass trajectory model", *Bull. Pol. Ac.: Tech.* 64 (1), 81–89 (2016).
 [17] L. Baranowski, "Feasibility analysis of the modified point mass trajectory model for the need of ground artillery fire control systems", *J. Theor. Appl. Mech.* 51 (3), 511–522 (2013).
 [18] STANAG 4355, *The Modified Point Mass and Five Degrees of Freedom Trajectory Models*, Edition 3, 2009.
 [19] L. Baranowski, "Effect of the mathematical model and integration step on the accuracy of the results of computation of artillery projectile flight parameters", *Bull. Pol. Ac.: Tech.* 61 (2), 475–484 (2013).
 [20] L. Baranowski, B. Gadomski, P. Majewski, and J. Szymonik, "Comparison of explicit and implicit forms of the modified point mass trajectory model", *J. Theor. Appl. Mech.* 54 (4), 1183–1195 (2016).
 [21] R.L. McCoy: *Modern Exterior Ballistics. The Launch and Flight Dynamics of Symmetric Projectiles*, Schiffer Publishing, 2004.

- [22] L. Baranowski and W. Furmanek, "The problem of validation of the trajectory model of 35mm caliber projectile tp-t in the normal condition", *Problemy Techniki Uzbrojenia* 42 (125), 35–44 (2013) (in Polish).
- [23] T.F. Coleman and Y. Li, "An Interior, Trust Region Approach for Nonlinear Minimization Subject to Bounds", *SIAM Journal on Optimization* 6, 418–445 (1996).
- [24] T.F. Coleman and Y. Li, "On the Convergence of Reflective Newton Methods for Large-Scale Non-linear Minimization Subject to Bounds", *Mathematical Programming* 67 (2), 189–224 (1994).
- [25] R.L. Pope, The analysis of trajectory and solar aspect angle records of shell flights. Theory and computer programs, Department of Defence, Defence Science and Technology Organization, Technical Report WSRL-0039-TR, Weapons Systems Research Laboratory, Adelaide, South Australia, 1978.
- [26] D. Shanks and T.S. Walton, A New General Formula for Representing the Drag on a Missile Over the Entire Range of Mach Number, NAVORD (Naval Ordnance Lab) Report 3634, Maryland, USA, May, 1957.