

LIMIT ANALYSIS OF GEOMETRICALLY HARDENING COMPOSITE STEEL-CONCRETE SYSTEMS

Piotr ALAWDIN¹, Krystyna URBAŃSKA

University of Zielona Gora, Institute of Building Engineering, Poland

Abstract

The paper considers some results of creating load-carrying composite systems that have uprated strength, rigidity and safety, and therefore are called geometrically (self-) hardening systems. The optimization mathematic models of structures as discrete mechanical systems withstanding dead load, monotonic or low cyclic static and kinematic actions are proposed. To find limit parameters of these actions the extreme energetic principle is suggested what result in the bilevel mathematic programming problem statement. The limit parameters of load actions are found on the first level of optimization. On the second level the power of the constant load with equilibrium preloading is maximized and/or system cost is minimized. The examples of using the proposed methods are presented and geometrically hardening composite steel-concrete system are taken into account.

Keywords: limit analysis, composite steel-concrete structures, geometrically hardening system, bilevel optimization

1. INTRODUCTION

The problem of preventing failures of load-carrying systems, including building constructions and bridges, is closely connected with the analysis of construction failure that can be of sudden or gradual nature. The paper considers issues of creating load-carrying systems whose failure occurs gradually under one-path monotonic or repeatedly variable quasistatic loadings, which enables to prevent a catastrophic failure. Due to geometry and topology of certain classes such

¹ Corresponding author: University of Zielona Gora, Institute of Building Engineering, Szafrana st 1, 65-516 Zielona Gora, Poland, e-mail: p.aliawdin@ib.uz.zgora.pl, tel.+48683282322

systems have uprated strength, rigidity and safety, and therefore are called geometrically hardening systems (GHS) [1-3].

The essential influence of geometrically nonlinear effects on the load carrying capacity is well known. This influence, being the result of structure configuration variation due to loading, may be both positive and negative (for example, in shakedown problems [4]). The investigations of one of the authors [5] on creating a new type of structures having uprated load carrying capacity, rigidity and reliability have lately appeared. The indicated structural features are found as a result of taking into account geometrical nonlinearity. This class includes suspension and wire systems with elements mainly in tension, but also combined systems with extended compressed elements, systems with special reinforcing and beams or plates with restricted longitudinal displacements.

The great sensitivity of carrying capacity and adaptation to the structure geometry and topology parameters was found in [6]. The analogous influence of prestressing was proved as a result of experiment by [7] for the elastic strut-framed column.

In this paper the problem of the external actions on the structure having uprated reliability is formulated on the first level optimization. On the second level optimization the other parameters are sought for the next quality of systems.

In such approach the definition "limit analysis" includes the serviceability limit state, namely the conditions constraining excessive deformations. So, the design engineer may now simultaneously consider two possible conditions of failure [1, 8-10].

The mathematical models and methods of limit analysis for the structures are stated in this paper. Load-carrying capacity of systems with regard to inelastic deformations and large displacements are considered. Material deforming diagrams can be non-monotonic and non-smooth [11-14]. The character of structures failure is identified by the solution of arising optimization problems. The non-uniqueness of problem solutions is investigated as well.

As formal attributes (class criteria) of geometrically hardening systems are adopted the conditions of plastic yielding stability of structures. With some extra conditions these criteria may be also applied to elastic systems, which have not arrived at the state of limit equilibrium.

Here is given a set of criteria for plastic yielding stability of structures, including for non-smooth and non-convex problems of optimization.

A similar problem of stabilization of unstable post-buckling behavior of elastic thin-walled cylindrical shells was discussed, for example, in [32]. The effect of stabilization of such structures is obtained not by changing its geometry (as usually), but by additional independent axial tension.

As shown in this study, constant load and preloading of structures took a positive effect on the behaviour of the systems GHS. Thus we have second level optimization of limit analysis problem, which deal with the dead load and cost of structure.

For practical implementation of such systems in the design of building structures and bridges we must have a current software package that implements a reliable analysis of the geometrically and physically nonlinearity of the systems. Here we used the numerical FEA system ABAQUS [15] and analytical/symbolic system Wolfram Mathematica [16].

2. PROBLEM STATEMENT

2.1. Governing conditions

The rod structures are modelled as discrete mechanical systems, having finite degree of freedom. They carry loads and kinematic actions (including temperatures, support settlements, distortions or dislocations), prestressing and dead forces. The loads and actions may be monotonically increasing or quasi-static cyclic, any dynamic effects are not considered. The material is ideal elastic-plastic, hardening or softening, here the deformation diagrams take the form of piecewise continuous and non-smooth functions.

Notations:

$u, F \in R^n$	- vectors of generalized displacements and external forces (loads) of discrete system of structure (n - number of degree of its freedom);
$q, e, p, d, S \in R^m$	- vectors of full, elastic and plastic generalized strains as well as vectors of given distortions and internal forces (m - dimension of internal forces and strain vectors; the total number of braces);
$\lambda, \varphi, \psi, \xi, K \in R^y$	- vectors of generalized plastic multipliers, functions of yielding and plastic constants for [1:y] yielding regimes (y - number of yielding regimes);
$F_j \in R^n$	- vectors of generalized independent j -th loadings, $j \in J$ (J - set of independent actions);
$T_j \in R^n$	- vectors of weight multipliers (fixed displacements), corresponding to j -th loadings $F_j, j \in J$;
$d_j, f_j \in R^m$	- the same vectors of j -th distortions and their weight multipliers;
Ω_F, Ω_d	- domains (sets) of forces F and distortions d ; indices e, r and p relate to elastic, residual and initial (prestressed) state parameters;
x	- vector of the system geometry; V - vector of the elements stiffness;
ρ	- vector of the parameters of the cost system elements.

2.2. Analysis of GHS systems

Let us consider the structure under the constant (dead) load F_c and variable (live) load F_v ,

$$F = F_c + F_v. \quad (2.1)$$

where live loads F_v belong to the domain Ω_F ,

$$F_v \in \Omega_F(F_j, j \in J), \quad (2.2)$$

like as distortions d of structures are varying within the domain Ω_d ,

$$d \in \Omega_d(d_j, j \in J), \quad (2.3)$$

the sets Ω_F and Ω_d are specified by characteristics of actions cycles; they may have the form of polyhedral with tops, linear depending on vectors of loadings F_j and distortions $d_j, j \in J$, [1].

The system state parameters of strain q are divided into elastic and plastic (residual) components, the latter are regarded as constant in time t in the state of adaptation, as well as given distortions,

$$q = e(t) + p + d. \quad (2.4)$$

The conditions of system state include the geometric and equilibrium equations

$$\gamma(u) = e + p + d, \quad (2.5)$$

$$A_n(u)S = F_c + F_v, \quad (2.6)$$

nonlinear physical relationship for large deformations

$$e = \xi(S), \quad (2.7)$$

as well as conditions of yielding in the form of inequality

$$\varphi(\cdot) \leq 0, \quad (2.8)$$

which are described in [1]. We consider an optional diagram for deforming and plastic yielding of materials having $|L|$ zones of hardening, softening or ideal plasticity; L – a set of l -th zones, $l \in L$ [6, 11].

In case of the associated law of yielding, the generalized plastic deformations are as follows

$$p = \sum_{l \in L} N_l \lambda_l \quad (2.9)$$

besides the complementary slackness conditions are fulfilled

$$\varphi_l^T \lambda_l = 0, \quad \lambda \geq 0, \quad l \in L. \quad (2.10)$$

$$(2.11)$$

If generalized elastic strains are connected with the internal forces by Hooke law, we have

$$e = DS, \quad (2.12)$$

where D – m -order block diagonal matrix of elasticity.

The criterion of yield state stability of plastic mechanism is

$$\begin{aligned} \Psi(u, \lambda) = & 2^{-1} \lambda^T B \lambda - \lambda^T C_N (\gamma(u) - d) - u^T F + \\ & + 2^{-1} \gamma(u)^T C \gamma(u) - \gamma(u)^T C d \rightarrow \min \end{aligned} \quad (2.13)$$

for some (smooth and convex) function Ψ , where

$$B = H + N^T C N \quad (2.14)$$

for

$$\lambda \geq 0. \quad (2.15)$$

In the compact form the problem will be as follow

$$\Psi(u, \lambda) \rightarrow \min, \quad \lambda \geq 0. \quad (2.16)$$

In the case of non-smooth dependences $S = \chi^-(e)$ (for the systems with unilateral of unsafe ties etc.) and also for the non-associated law of yielding, the formulation of problem will be

$$\Psi(u, \lambda, S, e) \rightarrow \min_{u, \lambda \geq 0}, \quad (2.17)$$

$$\Psi(u, \lambda, S, e) = \Psi_\xi(\lambda) - \lambda^T (\varphi_p(S) - K) + S^T \gamma(u) - u^T F, \quad (2.18)$$

$$\gamma_0(u, S) := -(\partial \Psi \partial S) + \gamma(u) - e - d = 0, \quad (2.19)$$

$$\chi_0(S, e) := S - \chi^- \epsilon = 0, \quad \lambda \geq 0, \quad (2.20)$$

where

$$\Psi_\xi(\lambda) = \int_0^1 \xi(\beta)^T \delta \beta. \quad (2.21)$$

$$\Psi_{\xi}(\lambda) = \int_0^1 \xi(\beta)^T \delta\beta. \quad (2.21)$$

The Eq. (2.13), (2.17) is obtained generally by algorithmic procedure. It is the criterion for a class of effective GHS structures proposed.

When geometrically nonlinear effects are taken into account, it is necessary to restrict displacements and/or plastic strains of the system

$$u^- \leq u \leq u^+, \quad (2.22)$$

$$p^- = \sum_{l \in L} N_l \lambda_l \leq p^+, \quad (2.23)$$

where $u^-, u^+ \in R^n$; $p^-, p^+ \in R^m$ – vectors of low and upper limits of corresponding values in the conditions of rigidity Eq. (2.22), (2.23).

3. PROBLEMS OF FINDING OPTIMUM LIMITS OF REPEATEDLY VARIABLE LOADS (FIRST LEVEL)

The problem of bilevel optimization is written as follows.

On the first level, at the system adaptation limit state the power of actions (independent loadings F_j , for the changing loads F_v , and distortions $d_j, j \in J$) in a cycle must be maximized.

$$\sum_{j \in J} (T_{F_j}^T F_j + T_{d_j}^T d_j) \rightarrow \max, \quad (3.1)$$

$$q = \gamma(u), \quad (3.2)$$

$$A_n(u)S = F_c + F_v, \quad (3.3)$$

$$q = e + p + d, \quad (3.4)$$

$$e = \kappa^{-1}(S) := \zeta(S), \quad (3.5)$$

$$p = \partial\psi \cdot \lambda, \quad (3.6)$$

$$\varphi(S, \lambda, K) := \varphi_p(S) - \xi(\lambda) - K \leq 0, \quad (3.7)$$

$$\lambda \geq 0, \quad (3.8)$$

$$\varphi^T \lambda = 0, \quad (3.9)$$

$$F_v \in \Omega_F(F_j, j \in J), \quad (3.10)$$

$$d \in \Omega_d(d_j, j \in J), \quad (3.11)$$

$$u^- \leq u \leq u^+, \quad (3.12)$$

$$p^- \leq \partial\psi \cdot \lambda \leq p^+, \quad (3.13)$$

$$\det M_k(S) \geq \varepsilon_s, \quad k \in K_a. \quad (3.14)$$

The inequalities (3.14) correspond to the earlier conditions (2.17).

Then, to determine the parameters of the limit actions on the structure, having uprated bearing capacity, we propose the following energetic principle:

Of all the statically admissible residual forces, plastic multipliers and corresponding plastic strains, satisfying the conditions of general stability and rigidity of the system, the actual ones are for which the power of the actions in a cycle is maximum.

Energetic principle for the large displacements analysis (3.1)-(3.14) is a problem of nonlinear mathematical programming. For the second order limit analysis the problem is simplified; we have only linear and bilinear conditions and functions with the exception of one quadratic inequality. For solving of this problem we use methods [17]. We can notice that the solution of shakedown problem on condition of stability (2.17) may not exist. Then this problem must be solved without these conditions, but it is necessary to consider the obtained residual forces as the prestressing forces, which are to be created in the structure before its loading [1].

The monotonically increasing loading is a particular case of a cyclic one for $|J|=1$; restriction (2.17) is not necessary now. If geometrical effects only of the second order are taking into account, the problem becomes the bilinear programming problem [5].

Problems of synthesis for such systems are formulated analogous with the problems of analysis. The report [2] presents some examples of analysis and synthesis of effective carrying structures as space strut-framed systems with queen posts inclined to center of strut, arch or suspended two- or multiflanges systems, foundations with special reinforcing. Some of these systems were

recognized as inventions and were realized in civil engineering [1]. It is shown here that, besides geometry and topology, prestressing greatly influences on optimal design of the system.

As noted in [1], “singular” (instantly-movable or instantly-rigid) constructions [18], whose prestressing state is stable, are always relative to geometrically hardening systems, regardless of the direction of loads acting on them. The similar conclusion would hold true both for “tensegrity systems” [19-20] and for their combination with geometrically “neutral” or all the more strengthening elements.

The book [1] proposes also some analytical and heuristic methods for creating geometrically hardening systems. These methods have been employed to analyze existing constructions, their rational strengthening, as well as to design new geometrically hardening systems.

4. PROBLEMS OF FINDING MINIMAL COST AND/OR OPTIMUM LIMITS OF PRELOADING (SECOND LEVEL)

Numerical analysis as following in this study shown, that constant load and preloading took a positive effect on the behaviour of the systems GHS. Thus we can provide the second level optimization of limit analysis problem, which deal with the dead load and/or cost of structure.

Constant (dead) load on the structure is always present, but sometimes it adds another additional preloading providing stabilization of the system. In any case, it is recommended to take such constant load with preloading, which is the “equilibrium” for the basic mechanism of the failure of the system. The term “equilibrium” load is known in the theory of geometrically changed suspension and cable-stayed structures [18]; it's a load that does not cause the kinematic displacements of such systems. For arbitrary constructions the “equilibrium” load does not cause the system's kinematic displacements in the state of limit equilibrium.

Finally, on the second level we minimize system cost C and/or maximize the power of the constant load with equilibrium preloading F_c ,

$$C(x, V, \rho) \rightarrow \min , \quad (4.1)$$

$$T_c^T F_c \rightarrow \max . \quad (4.2)$$

Since preloading increases the mass and cost of systems, we can provide a task to minimize it, at the same time using its positive influence. Such a problem is a

generalization of a statement of the optimization problem of bearing capacity of arbitrary rigid-plastic systems for one-path loading [9].

Note, that criteria (4.1) and (4.2) here are taken into account simultaneously, with weight multipliers, but it is possible to consider this criteria one by one. The solving of the vector (or multiobjective, multicriteria) optimization problem was analyzed in many works, e.g. [21-22]. The theory of bilevel optimization at present is intensively developing [23-27, 31].

5. NUMERICAL ANALYSIS OF COMPOSITE GHS SYSTEM

5.1. Analysis of strut-framed beam

Calculations were carried out for the rod system, worked in plastic state. All calculations have been made by used physically and geometrically nonlinear analysis. The numerical solution of problem was found by the finite element method (FEM), using program ABAQUS/Standard [15] include nonlinear analysis (NLgeom). Firstly were analysed the strut-framed beam simply supported at ends. Composite beam was assembly with steel I-beam (PN-300) with height 30 cm and length $l = 12$ m and concrete plate with cross section $c \times h_2 = 1,0 \times 0,1$ m. (Fig.1d). Steel beam was connected with bars of steel truss and were loaded by concentrated forces F at the two nodes of beam, see Fig. 1a. Height of the rod system was $h=2$ m. Four variants of the grid model were taken into analysis, for $b = 2$ and 3m (Fig. 1a) and also $b = 4$ and 5m (Fig. 1b, c), for the following load cases:

- (1) without preloading: node 3 was loaded only by the varied force up to $F_3 = 600$ kN while $F_5 = 0$ kN,
- (2) with additional “equilibrium” preloading at node 5 with constant value $F_5 = 200$ kN and with the same varied force F_3 .

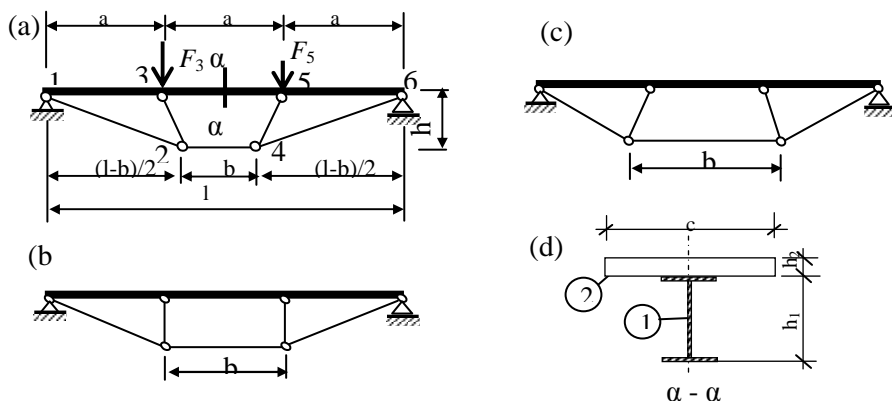

Fig. 1. Scheme with loading of the rod system: (a) $b < l/3$; (b) $b = l/3$; (c) $b > l/3$

The material parameters for plate, beam and truss were taken as follows. For material of plate the modulus of elasticity $E_c = 30$ GPa; Poisson's coefficient $\nu = 0,2$; yield stress $\sigma_0^c = 10$ MPa. For beam elements $E_s = 210$ GPa; Poisson's coefficient $\nu = 0,33$; yield stress $\sigma_0^s = 235$ MPa and for bars 1-2, 2-4 and 4-6 was taken stiffness equal $EA_1 = 210$ MN and for the rest of bars: 2-3 and 4-5 was taken stiffness $EA_2 = 21\ 000$ MN.

The numerical calculations were made for the following material models: ideal elastic-plastic for composite beam, and ideal elastic truss elements.

In the FEM analysis the concrete plate was modeled using Shell elements (S4R), the steel beam was modelled using tree-dimensional beam element with two nodes (B31), for the bars was used tree-dimensional truss element with two nodes (T3D2).

Full contact of the bottom layer of plate and top of the beam was carried out in Abaqus as a continuous contact of type „tie”. Coupling of steel beam with bars of steel truss was modeled like MPC Constraint.

The aim of numerical calculations was to estimate limit load capacity of system for different truss cases (Fig.1a, b, c) without ($F_5 = 0$ kN) and with preloading ($F_5 = 200$ kN) and observation of behavior the rod system over limit load equilibrium. The results of numerical calculations are shown in Figures 2, 3.

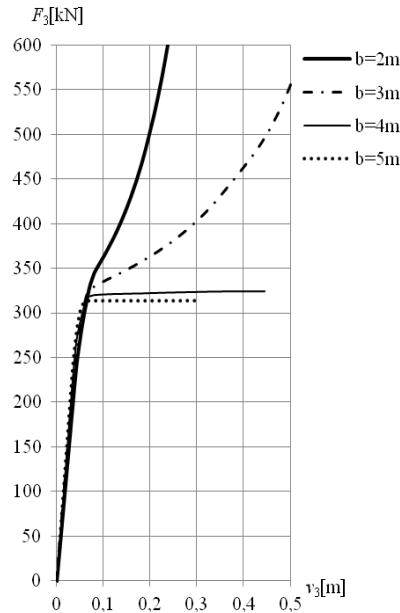

Fig. 2. Load F_3 versus displacement v_3 diagram for system without preloading ($F_5=0$)

The limit load capacity F^0 for case without dead load and preloading of node 5 ($F_5=0$) was estimated for every truss cases on the level 320 kN, see Fig. 2.

Geometrically hardening effect (go up branch of a curve $F_3.v_3$ on Fig. 2) was observed only for truss with skew posts ($b = 2$ and 3 m).

When the limit load capacity was obtained in the cases for $b = 4$ and 5 m we can observe formation larges displacements and then failure of construction.

Figure 3 presents the relationship between load F_3 and the vertical displacement v_3 for system with loading of node 3 by the force $F_3 = 600$ kN and loading of node 5 by the force $F_5 = 200$ kN.

In this case limit load capacity was estimated on the level 400 kN. For example, for truss with $b < 1/3$ increase of load capacity (geometrically hardening effect) was about 20%, see Fig. 3.

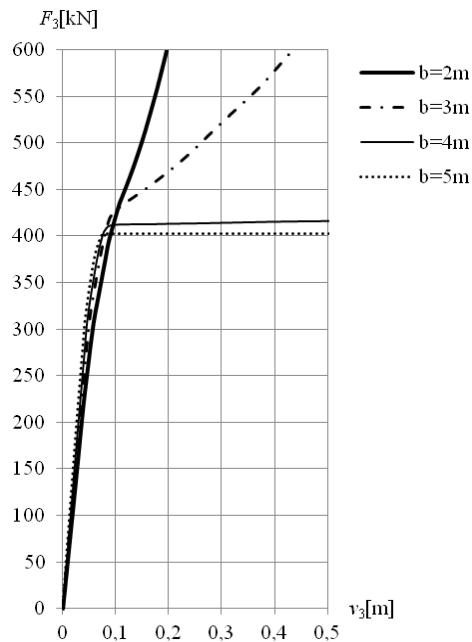

Fig. 3. Load F_3 versus displacement v_3 diagram for system ($F_5>0$)

When the load F_3 increases in the construction of this type the first plastic hinge was made on the left of node 3, then the second plastic hinge arises on the right of node 5, and system is changing in kinematic mechanism, see Fig. 4.

The dependence of displacement v_3 versus load F_3 for $b = 2$ m was made for two cases of loading, see Fig. 4. The diagrams show the points (1) and (2) where

plastic hinges were created. For the system without preloading the points (1) and (2) corresponded with the forces $F_3 = 260$ kN and 320 kN.

However, for the system with dead load and preloading of node 5, the first plastic hinge (1) was appeared for $F_3 = 309$ kN, and the second plastic hinge (2) for $F_3 = 420$ kN. The lines on the diagrams F_3-v_3 over plastic hinge (2) go up and approach a limit, see Fig. 4. Thus, the dead load and additional preloading in node number 5 caused the increase of load capacity and can be expressed as

$$(F^{**} - F^*) / F^0, \quad (4.3)$$

where F^0 is limit load capacity when $F_5 = 0$, F^{**} and F^* are loads in node number 3 in the system with and without preloading for the same displacement v_3 . In this example $F^0 = 320$ kN and for $v_3 = 15$ cm, $F^{**} - F^* = 91$ kN.

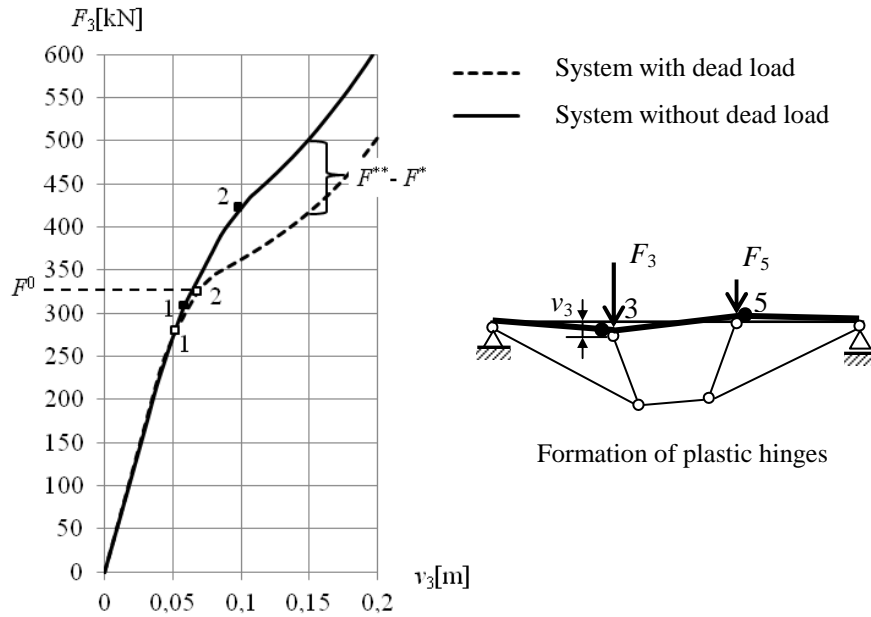

Fig. 4. Load F_3 versus displacement v_3 diagram for $b = 2$ m

Preloading of construction caused the increase of load capacity about 28%. It is an advantage of such geometrically hardening systems.

This specific quality was confirmed by analytical calculations [1]. The results of calculations using system Wolfram Mathematica are shown in Figure 5. For the rod system, showed on Fig. 5, every bars of truss had a stiffness $EA \rightarrow \infty$.

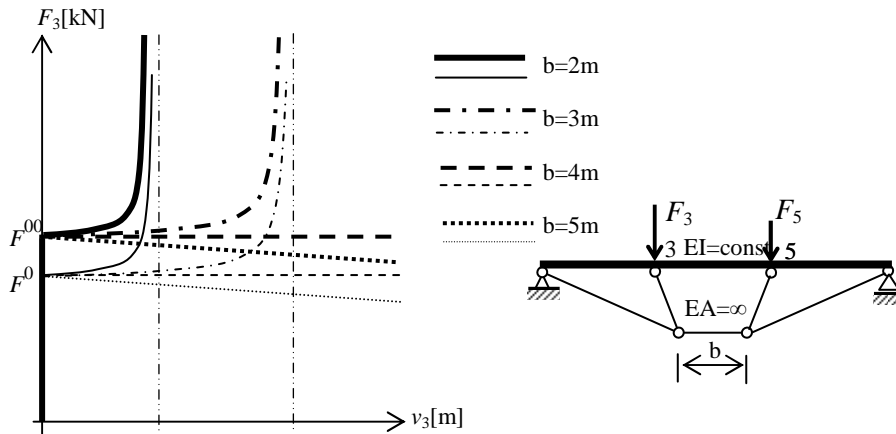

Fig. 5. Load F_3 versus displacement v_3 diagram for systems with dead load ($F_5 > 0$) – more thickness lines and without dead load ($F_5 = 0$) – thin lines

The obtained numerical and analytical results show that geometrically hardening effect and taking into account dead load and preloading (constant or variable) is important for the design of this type structures.

5.2. Analysis of viaduct system

Another example of this type object can be the viaduct WD-22 (Fig. 6) in grade-separated interchange „Pyrzyce” on express road S3 [28].

Load-bearing structure of this viaduct is a system composes with reinforced concrete beam reinforced by steel arch, steel braces and concrete construction [29, 30].



Fig. 6. View of viaduct WD-22 [29]

The numerical calculations of similar system were found by the finite element method (FEM), using program ABAQUS/Standard [15] with geometrically and physically nonlinear analysis.

Fig. 7 shows the simplified scheme with loading of viaduct WD-22. Span of arch beam was $L = 54$ m and high $H = 11$ m. Beam was supported at ends and loaded by forces $F_1 = 600$ kN and $F_2 = 100$ kN at the nodes 1, 2.

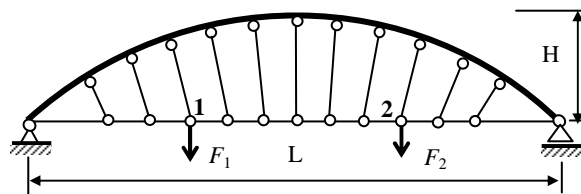

Fig. 7. Simplified scheme and loading of the viaduct WD-22

Figure 8 presents the relationship between variable load F_1 and the vertical displacement v_1 of 1st node with the constant force F_2 on the viaduct.

In the construction on this type the dead load and additional preloading always caused increase of load capacity. In this example the increase of load capacity was on the level 15%.

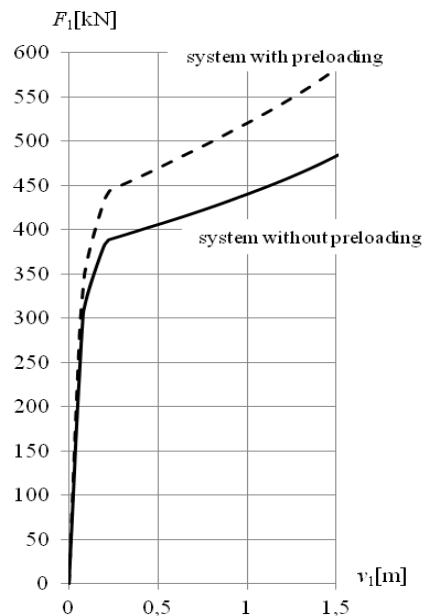

Fig. 8. Load F_1 versus displacement v_1 diagram for the viaduct

It should be noted that for the systems with composite beams, in which the bending stiffness varies with different moment signs (depending on the direction of deformation and the presence of a normal tensile force), the effect of GHS rigidity will be relatively different than that for the constructions made from homogeneous materials [3]. However the increase of load capacity as a result of structure geometry change remains just like this.

6. CONCLUSION

The paper considers issues of certain classes systems which have updated strength, rigidity and safety, and therefore they are called geometrically (self-) hardening systems (GHS). The failure of such systems occurs gradually under one-path or repeatedly variable quasistatic loadings.

The mathematical models and methods of limit analysis for the GHS composite structures are also stated in this paper. Load-carrying capacity and shakedown of systems with regard to inelastic deformations and large displacements are considered.

As criteria of geometrically hardening systems are adopted the conditions of plastic yielding stability of structures. Yet with some extra conditions these criteria may be also applied to elastic systems, which have not arrived at the state of limit equilibrium. Here is given a set of known and new criteria for plastic yielding stability of structures.

The numerical calculations of GHS systems in this paper show that taking into account the equilibrium constant load with preloading cause the increase of load capacity up to 15-30%. Additional or existing load (constant or variable) causes geometrically hardening effect in these systems.

The optimization problem is formulated as a bilevel mathematic programming one. To find limit parameters of load actions the extreme energetic principle is suggested on the first level. On the second level of optimization the system cost is minimized and/or power of the constant equilibrium load with preloading is maximized.

Examples of using the proposed methods are given, and analysis of geometrically hardening composite system is made.

REFERENCES

1. Aliawdin, P. W.: *Limit analysis of structures under variable loads*, Minsk, Technoprint 2005. (in Russian).
2. Aliawdin, P., Silicka, E.: *Limit analysis and failure of load-carrying systems*, Selected papers of the 9th International Conference on Modern

- Building Materials, Structures and Techniques, 16–18 May 2007, Vilnius, Lithuania III (2007) 881-886.
3. Alawdin P., Urbańska K.: *Limit analysis of geometrically hardening rod systems using bilevel programming*, in: 11th International Scientific Conference on Modern Building Materials, Structures and Techniques, Vilnius, Lithuania 2013, 89-98.
 4. Maier, G.: *A shakedown matrix theory allowing for workhardening and second-order geometric effects*, in: Foundations in plasticity, 1, Ed. A. Sawczuk, Noordhoff, 1973, 417-433.
 5. Alyavdin, P.W.: *A new class of effective carrying structures: Analysis and synthesis*, Architecture and Civil Engineering of Belarus, 5-6, (1994) 6-10 (in Russian).
 6. Alyavdin, P.: *Optimization problem for a new class of effective carrying structures*, Proc. of the Second World Congress of Structural and Multidisciplinary Optimization (WCSMO-2), 26-30 May 1997 Zakopane, Poland, 2, 905-910.
 7. Voyevodin, A.A.: *Prestressed systems of structures elements*. Strojizdat 1989. (in Russian).
 8. König, J.A.: *Shakedown of elastic-plastic structures*. PWN, Elsevier 1987.
 9. Čyras, A., Borkowski, A., Karkauskas, R.: *Theory and methods of optimization of rigid-plastic systems*. Technika, Vilnius 2004.
 10. Atkočiūnas, J.J.: *Analysis of elastic-plastic systems at repeated loadings* Publishing house of a science and encyclopedias 1994. (in Russian).
 11. Alyavdin, P., Simbirkin, V.: *Analysis of RC elements under monotonic and cyclic loadings taking into account nonsmooth stress-strain diagrams*, Proc. of International Conference on Nonsmooth/nonconvex mechanics with applications in engineering, Thessaloniki, Greece, 2002, 401-408.
 12. Gao David Yang, Ogden Ray W.: Stavroulakis Georgios, E., *Nonsmooth/Nonconvex mechanics: Modeling, analysis and numerical methods / Nonconvex optimization and its applications*, 50, Kluwer Academic Publishers, 2001.
 13. Gawecki, A., Kruger, P.: *Slackened systems under variable loads*, in: Inelastic Behaviour of Structures under Variable Loads, Z. Mróz et al. (Eds.). Kluwer Academic Publishers 1995, 399-417.
 14. Telega, J.J.: *On shakedown theorems in the presence of Signorini conditions and frictions*, in: Inelastic Behaviour of Structures under Variable Loads, Z. Mróz et al. (Eds.). Kluwer Academic Publishers 1995, 183-202.
 15. ABAQUS User's Manual. 2010. Version 6.10, Hibbitt, Karlson and Sorensen, Jnc.

16. Cap, F.E.: *Mathematical methods in physics and engineering with MATHEMATICA*. A CRC Press Company, 2003.
17. Dem'yanov, V.F., Stavroulakis, G.E., Polyakova, L.N., Panagiotopoulos, P.D.: *Quasidifferentiability and Nonsmooth Modelling in Mechanics*, Engineering and Economics / Nonconvex Optimization and Its Applications, 10, Kluwer Academic Publishers, 1996.
18. Kuznetsov, E.N.: *Underconstrained Structural Systems*. Mechanical Engineering Series, XIII, Springer Verlag 1991.
19. Motro, R.: *Tensegrity: Structural Systems for the Future*. Kogan Page, Limited 2003.
20. Murakami, H.: *Static and dynamic analysis of tensegrity structures. Part 1. Nonlinear equations motion. Part 2. Quasi-static analysis*, International Journal of Solids and Structures, 38 (20), 2001, 3599–3613; 3615–3629.
21. Gorokhovik, V.V.: *Convex an nonsmooth problems of vector optimization*, Navuka i Tekhnika 1990. (in Russian).
22. Eichfelder, G.: *Adaptive scalarization methods in multiobjective optimization*, Springer 2008.
23. Dempe, S.: *Foundations of bilevel programming*, Kluwer Academic Publishers, 2002.
24. Demyanov, V., Facchinei, F.: *Two-level optimization problems and penalty functions*, Russian Math. (Izv. VUZ) 47(12) 2003, 46-58. (in Russian).
25. Shimizu, K., Ishizuka, Yo., Bard, J.F.: *Nondifferentiable and two-level mathematical programming*, Kluwer Academic Publishers 1997.
26. Strekalovsky, A.S., Orlov, A.V., Malyshev, A.V.: *Numerical solution of a class of bilevel programming problems*, Siberian J. Num. Math. / Sib. Branch of Russ. Acad. of Sci. 13(2) (2010), 201–212 (in Russian).
27. Malyshev, A.V., Strekalovsky, A.S.: *About interconnection of some prolems of bilevel and nonlinear optimization*, Russian Math. (Izv. VUZ) 4, 2011, 99-103. (in Russian).
28. Sołowczuk, A. (Ed.): *Express road S3 on the itinerary Szczecin-Gorzów Wlkp.*, Publishing house Comgraph Anna Jadczyk, Szczecin 2010. (in Polish).
29. Sołowczuk, A., Matecki, K.: *Selected road structures over the S3 express road*, Engineering and Construction, 5 (2011), 284-287 (in Polish).
30. Project documentation of structures over the S3 express road on the itinerary Szczecin-Gorzów Wlkp., 2011. Contract engineer office DHV, Poland, Sp. z.o.o. (in Polish).
31. Optimization with Multivalued Mappings: Theory, Applications and Algorithms / Optimization and Its Applications, 2, XII, Dempe S., Kalashnikov V. (Eds.), Springer 2006, p. 276.

32. Kruzelecki, J., Trybuła, D.: *Optimal axial tension and internal pressure stabilizing post-buckling path for cylindrical shells under torsion*, Journal of theoretical and applied mechanics, Warsaw, 48, 3 (2010), 645-658.

STANY GRANICZNE GEOMETRYCZNIE WZMACNIAJĄCYCH SIĘ KONSTRUKCJI ZESPOLONYCH

Streszczenie

W pracy przedstawiono sposoby projektowania konstrukcji, które ze względu na swoją geometrię oraz topologię posiadają podwyższoną nośność, sztywność i bezpieczeństwo. Systemy takie nazwano geometrycznie (samo-) wzmacniającymi się. Zaproponowano optymalizacyjne modele matematyczne konstrukcji jako dyskretne systemy mechaniczne będące pod obciążeniem stałym, zmiennym monotonicznym lub niskocyklowym, statycznym lub kinematycznym.

Dla znalezienia granicznych parametrów obciążeń wprowadzona została ekstremalna zasada energetyczna, przedstawiona jako problem dwupoziomowego programowania matematycznego. Graniczne parametry obciążeń szukane są na pierwszym poziomie optymalizacji. Na drugim poziomie minimalizowany jest koszt systemu i/lub maksymalizowana jest moc stałego równoważącego obciążenia z dociążeniem.

Ponadto w pracy przeanalizowano numerycznie i analitycznie zachowanie konstrukcji geometrycznie wzmacniających się na przykładzie konstrukcji zespolonych stalowo-betonowych. Pierwszy przykład dotyczy konstrukcji belkowo-prętowej z podciągami, belkę stanowi stalowy dwuteownik połączony z płytą betonową. Analizowano cztery przypadki skratowania podciągu wykonanego z prętów stalowych o przekroju kołowym i znacznej sztywności słupów. Pokazano znaczący wpływ orientacji słupów podciągu na nośność konstrukcji. Drugi przykład numeryczny wykonano dla uproszczonego modelu wiaduktu WD-22 znajdującego się na węźle „Pyrzyce” na drodze ekspresowej S3.

Dla obu przykładów realizowano dwa przypadki obciążania konstrukcji, bez uwzględnienia i z uwzględnieniem stałego równoważącego obciążenia z dociążeniem. Obliczenia numeryczne wykonano w środowisku systemu Abaqus/Standard stosując analizę geometrycznie nieliniową (NLgeom). W obliczeniach przyjęto następujące modele materiałowe: dla belki żelbetowej - idealnie sprężysto-plastyczny natomiast dla prętów stalowych podciągu - sprężysty. Celem analizy była obserwacja zachowania się konstrukcji po osiągnięciu obciążenia granicznego dla różnych przypadków skratowania oraz oszacowanie nośności granicznej dla konstrukcji bez stałego obciążenia oraz ze stałym obciążeniem i dociążeniem. Na podstawie przeprowadzonych obliczeń numerycznych i analitycznych stwierdzono, że w różnych konstrukcjach o pewnych wymiarach skratowania obserwuje się wzmocnienie geometryczne po osiągnięciu przez system nośności granicznej. Uwzględnienie obciążenia stałego równoważącego oraz

dodatkowego dociążenia powoduje wzrost nośności granicznej konstrukcji geometrycznie wzmacniających się o około 20 %.

Słowa kluczowe: obciążenia graniczne, konstrukcje zespolone, geometrycznie (samo-) wzmacniające się systemy , optymalizacja

Editor received the manuscript: 8.10.2014

