

Technical Note

Analysis of the Usefulness of Measurement on a Board at Ground Level for Assessing the Noise Level from a Wind Turbine

Tadeusz WSZOŁEK*, Paweł PAWLIK, Dominik MLECZKO, Jagna CHRONOWSKA

*AGH University of Science and Technology
Faculty of Mechanical Engineering and Robotics
Department of Mechanics and Vibroacoustics
Al. Mickiewicza 30, 30-059 Kraków, Poland*

*Corresponding Author e-mail: twszolek@agh.edu.pl

(received February 20, 2019; accepted October 28, 2019)

The specific working conditions of the wind turbine in strong wind cause a number of problems in the measurement of noise indicators used in its short and long-term assessment. The wind is a natural working environment of the turbine, but it also affects the measurement system, moreover, it can be a secondary source of other sounds that interfere with the measurement. One of the effective methods of eliminating the direct impact of wind on the measurement system is placing the microphone on the measurement board at ground level. However, the obtained result can not be directly compared with the admissible values, as it has to be converted to a result at a height of 4 m. The results of previous studies show that this relation depends, inter alia, on the speed and direction of the wind. The paper contains the results of measurements on the measurement board, according to EN 61400-11:2013, and at a height of 4 m above ground made simultaneously in three points around the 2 MW turbine at various instantaneous speeds and changing wind directions. Analysis of the impact of measuring point location on the measurement result of noise indicators and the occurrence of additional features affecting the relationship between the values measured on the board and at the height of 4 m, and especially the tonality, amplitude modulation and content of low frequency content, was made.

Keywords: wind turbine noise; amplitude modulation; acoustical measurements; environmental acoustics.

1. Introduction

The specific working conditions of the wind turbine in strong wind cause a lot of problems in the measurement of noise indicators used in its short and long-term assessment. Wind is a natural working environment of the turbine, but it affects its acoustic (and electric) power, sound propagation conditions and the measurement system, moreover it can be a secondary source of other sounds (turbulence, leaf noise, etc.) affecting the measurement result (KENDRICK *et al*, 2016). An effective method of eliminating the wind impact on the measurement system is placing the microphone on the measurement board at ground level (WSZOŁEK, KŁACZYŃSKI, 2014). However, there remains the problem of the relationship between the value of the noise indicator measured in such conditions to the value measured at a height of 4 m above

ground level in accordance with the requirements of the reference methodology in Poland.

The sound level used for noise assessment should be determined under free field conditions. If reflective surfaces other than the ground are present nearby, this should be included in the calculation. For a microphone located near a reflecting surface, where the reflected sound has the same energy as the direct sound, 3 dB correction is applied. In the case of a microphone placed directly on the measuring board, when the reflected sound is in phase with the direct sound, a 6 dB correction (exactly 5.7 dB) is applied. In the case of a 13 mm microphone, when the sound comes from many directions, this relationship is valid in the band below 4 kHz (ISO 1996-2: 2017). A similar situation occurs in the case of a microphone on a measuring board, as per EN 61400-11:2013. However, the value of this correction may differ significantly in real

conditions, so it was considered that this relationship should be verified experimentally.

Measurements according to this methodology should not be carried out with wind speed greater than 5 m/s. This applies to the wind speed measured at a height of 4 m above the ground level (a measuring microphone is also placed at this height). However, the wind speed at the hub height can be much higher, but not as much so that the turbine, with such wind in stable wind profile, works with nominal power, usually achieved at wind speed of 12–15 m/s, especially in case of older generation turbines (KŁACZYŃSKI, WSZOLEK, 2014). Modern turbines are designed so that the sound power characteristics reach saturation at rated speed and a further increase in wind speed results in only a slight increase in the sound power. This is achieved by limiting the rotor tip speed. This has practical significance, because the wind speed at a height of 4 m above ground level corresponding to the nominal speed at the hub height, in stable atmosphere conditions, usually does not exceed 4–6 m/s, on the other hand there is no need to make measurements at higher wind speeds (because the power no longer increases). It is worth adding that the wind speed profile can be substantially different at daytime and at night. However, this is more important in modelling, and less in noise measurements from wind turbines (WSZOLEK *et al.*, 2014a).

Another problem besides estimating the instantaneous turbine sound power is amplitude modulations and impulsiveness (thumping) (EGEDAL *et al.*, 2017; LARGE *et al.*, 2017). Thumping is more strongly felt in the stronger wind, further away from the turbines, especially late in the evening and at night, when the wind speed increases strongly with the altitude, much more than would be expected from the wind logarithmic profiles (VAN DEN BERG, 2004) recommended in the standard (EN 61400-11:2013). In turn, the problem of amplitude modulation is particularly complicated with a larger number of turbines, when “single modulations” overlap creating a resultant modulation in a given place (point of observation). The strongest modulations are observed in the side wind directions (MCCABE, 2011). The frequency of modulation is related to the rotational speed – the frequency blade passing next to the tower and is usually about 1 Hz (PAULRAJ, VÄLISUO, 2017; PLEBAN, RADOSZ, 2015). There are also modulations in bands with much higher frequencies.

In connection with the above conditions, several measurement problems arise: the choice of the time interval in which measurements are made for specific turbine operation parameters; eliminating the wind influence on the measurement result – in scope of propagation and impact on the measurement system or in the generation of secondary sounds (tree noise, etc.) and the characteristic features of the acoustic signal

affecting the acoustic nuisance of the turbine (GOLEC *et al.*, 2006).

2. Description of the research object.

Research conditions

The subject of the research was the Gamesa G87 wind turbine which is part of Galicja/Hnatkowice – Orzechowce wind farm, about 7 km north of Przemyśl. The farm was launched in 2009 and is composed of 6 turbines type Gamesa G87 with a total capacity of 12.24 MW and is part of the company PGE Energia Odnawialna S.A. Each turbine is mounted on a tower with a height of 78 m. The nominal power is 2 MW and the rotor diameter is 87 m. It is equipped with 3 rotor blades made of carbon fiber. The maximum speed of the generator is 19 RPM, at which the tip speed of the blades is 87 m/s (approx. 313 km/h). The Gamesa G87 is fitted with a spur/planetary gearbox. The gearbox has 3 stages. At a wind speed of 4 m/s, the turbine starts its work. The cut-out wind speed is 25 m/s (GAMESA G87, n.d.).

The general location and farm plan are shown in Fig. 1.

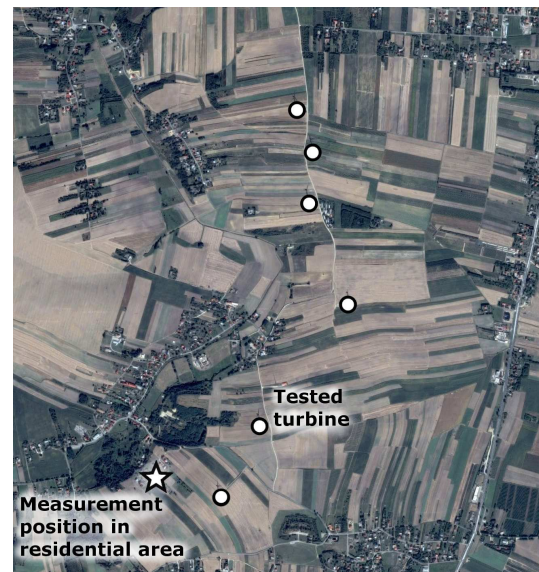

Fig. 1. Situational plan for the Galicja/Hnatkowice – Orzechowce wind farm (circle – turbine positions, star – measurement position in residential area), source: maps.google.pl.

There are two groups of indicators used in Poland to assess noise in the environment: (1) L_{DEN} and L_N used in long-term policy of environmental protection against noise and (2) L_{AeqD} and L_{AeqN} used to determine and control the conditions of using the environment in relation to one day (KORBIEL *et al.*, 2017). The methods for determining these indicators are included in the Regulation of the Minister of Environment (Journal of Laws, 2008). However, they refer to

typical sources of industrial noise, with the limitation, inter alia, in the wind speed range ($v_{\max} = 5 \text{ m/s}$), at which measurements can be made (WSZOLEK *et al.*, 2014b). To measure the noise at a height of 4 m above ground level it is necessary to use a wind screen or convert the measured value on the ground to the desired height. Examples of wind screens with spherical constructions located at a higher height are shown, inter alia, in (TASHIBANA *et al.*, 2013). However, such covers also provide sound attenuation. That is why the method of measurement on a plate with single half wind-screen (shown in Fig. 2) (without secondary wind screen) was adopted in the work, while the measurement at a height of 4 m was made with the use of a classic wind screen (HANSEN *et al.*, 2013).

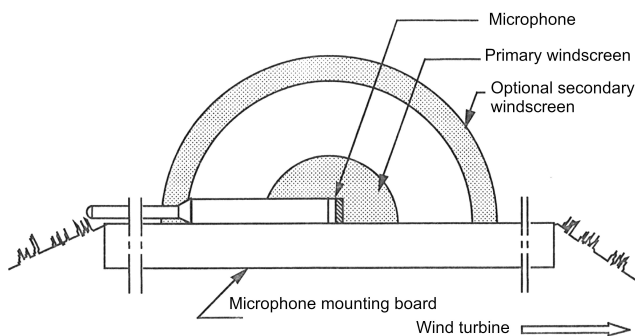

Fig. 2. Secondary wind screen, according to (EN 61400-11:2013).

The measuring points were located at a distance R_0 from the turbine equal the hub height plus half of the rotor diameter, in this case 121.5 m. The location of these points (1, 2, 3), in accordance with the recommendations of (EN 61400-11:2013), is illustrated in Fig. 3. The measurement was carried out simultaneously in six microphone positions (three points for two positions in each point – on the board and at a height of 4 m). The position of the microphone at a given

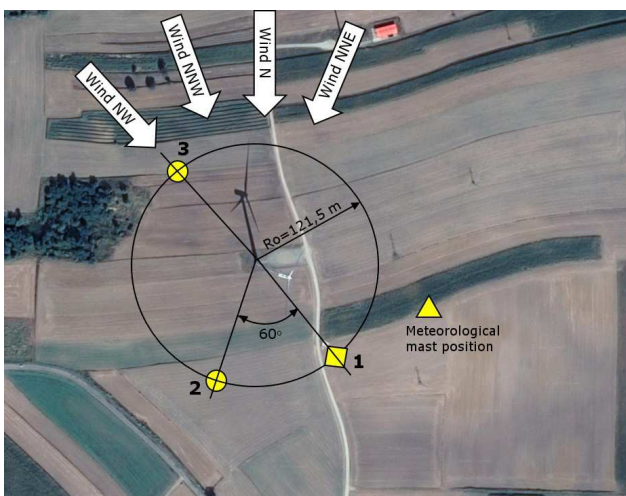

Fig. 3. Acoustic measurement positions near the Gamesa G87 turbine in Orzechowce, source: maps.google.pl.

point is shown in Fig. 3. The measurement of wind speed and direction and other weather parameters was carried out at a height of 10 m, Fig. 4a.



Fig. 4. Location of acoustic measurement positions near the Gamesa G87 turbine in Orzechowce: a) point 1, b) point 2, c) point 3.

In addition, the turbine rotational speed was controlled, which was constant during the entire measuring session and was equal about 15 rpm, which is 79% of the maximum turbine speed.

3. Acoustic measurements

3.1. Acoustic instruments and measurements procedures

The sound pressure time plots were recorded in points 1 and 2 using a recorder built in the LabVIEW environment using NI 9234 measuring cards with $1/2''$ 46AE, $1/4''$ 40PH microphones. In point 3, the sound pressure levels were recorded directly with the SVAN 958 analyzer on two channels simultane-

ously, while in point 4, at the residential building with the SVAN 959 analyzer. In points 3 and 4, measurements were made with $1/2''$ G.R.A.S. 40 AZ.

The results in the SVAN analyzers were recorded every 5 min. Independently, the continuous time plot was recorded in loggers with a time step of 0.5 s. All was recorded in $1/3$ octave bands in the frequency range of microphones and with A, C, Z correction filters. The total measurement time was more than 2 hours. However, for the comparison of results at various points, five-minute sections were chosen in which there were no major disturbances preventing such comparison. During the measurements, the wind speed and direction changed quite dynamically (a storm was approaching), as indicated in Fig. 4. Along with the change of wind direction, the turbine position was automatically changed in relation to the measurement points. However, due to the aforementioned dynamics of changes, the position of the measuring points was not corrected so that it was constant in relation to the current wind direction and the related turbine orientation. However, neither the change of wind direction nor its speed were so fast as to prevent a few minutes of measurement in stable conditions, as illustrated by the plot of wind speed and direction at a height of 10 m in Fig. 5. As can be seen in Fig. 5, and in the further results, despite the changing parameters, the wind speed at the height of the measurement (10 m) the more even less at a lower height was not high enough to be a secondary noise source. In addition, the lack of trees and other vegetation in the immediate surroundings meant that the background noise level was very low.

Nevertheless in practice, it is not possible to measure the background noise, but only to estimate it when the turbine is off or in a remote place where the turbine is no longer audible. Both methods have their pros and cons and bring uncertainty. In the present case it was not possible to turn off the turbines, also measurement in a remote place was in practice impossible due

to the large range of audibility of all turbines. Similar problems associated with the assessment of background noise can be found in the literature (LARGE *et al.*, 2017; PAULRAJ, VÄLISUO, 2017). In this situation, the option was consciously chosen, in which both measurements (on the board and at a height of 4 m) were left loaded with a similar background. Secondary noise from the wind appeared just before the storm, but these results were not taken into account.

3.2. Measurement results

In general, the measurement results can be divided into two categories. One is spectral analysis of recorded time plots in $1/3$ octave bandwidths and selected FFT spectrum results, mainly to show tonal components of noise generated by turbines at different wind speeds and directions, in particular quantitative and qualitative differences between measurement at ground level and at 4 m above the ground. The second category are time plots of sound pressure levels in frequency bands with higher levels and increased spread of results, indicating the possibility of modulation.

The combination of $1/3$ octave spectra on the plate and at a height of 4 m above ground level in point 1, with a wind speed of 1.7 m/s and NW direction, is shown in Fig. 5. Results dispersion was presented using the standard deviation of levels with the time constant “fast”. These results apply to the case when measurements positions are strictly in line with the requirements set by the standard (EN 61400-11:2013) in relation to the wind direction and the orientation of the turbine. As can be observed, both the levels and their dispersions in the bands with center frequencies of 63 Hz and 80 Hz are clearly greater.

At the wind speed of 1.7 m/s there are no significant differences between the results on the measurement board and at a height of 4 m above ground, neither in the 63 and 80 Hz bands nor in the other bands.

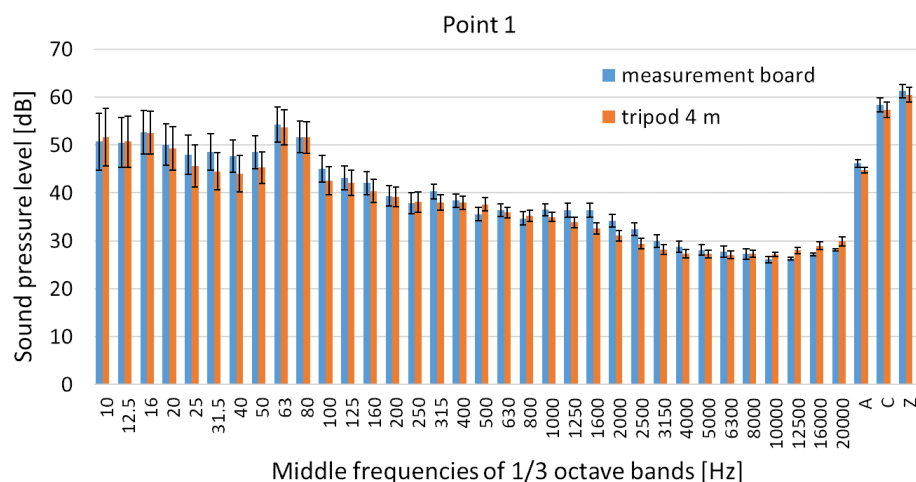

Fig. 5. The results of measurement in point 1 – wind speed 1.7 m/s, direction NW.

More significant differences can be observed in the sound pressure level time plot, filtered using a band-pass filter with cut-off frequencies of 50 Hz and 80 Hz (Fig. 6).

Fairly similar trends as at wind speed of 1.7 m/s and NW direction, are also observed at a speed of 3.8 m/s and NNW direction (Fig. 7).

The spectrum graph shows increased levels in the 63 and 80 Hz bands and slight differences between the measurements on the board and at a height of 4 m. However, there are noticeably higher levels at a height of 4 m in the bands below 50 Hz, which indicates the already noticeable effect of wind on the measurement result.

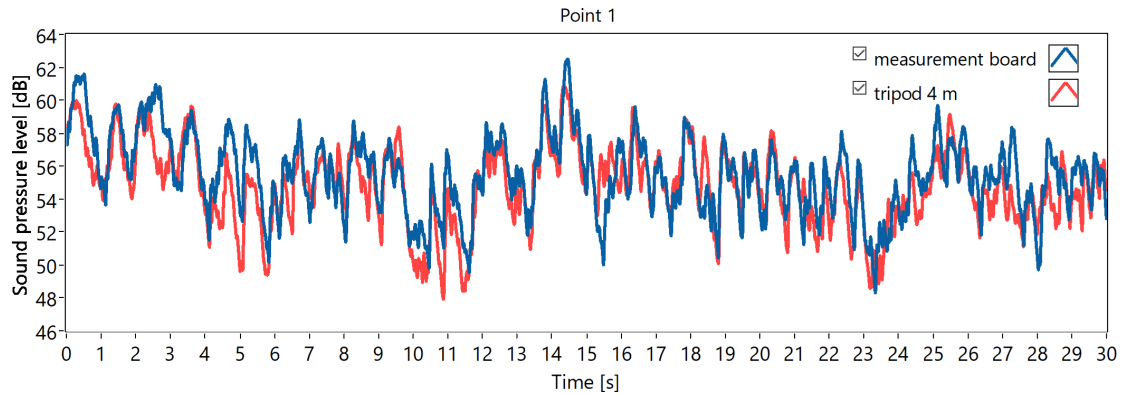

Fig. 6. Time plot of the sound pressure level filtered in the band from 50 Hz to 80 Hz – wind speed 1.7 m/s, direction NW. Measurement point 1.

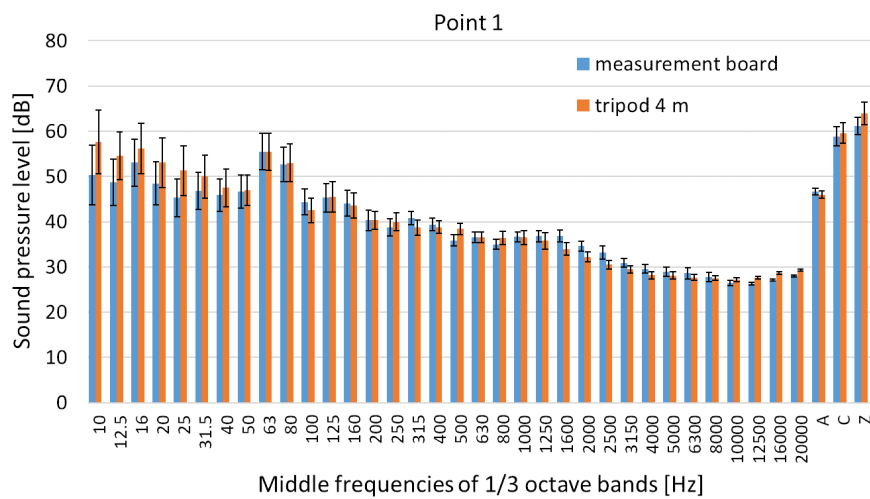

Fig. 7. The results of measurement in point 1 – wind speed 3.8 m/s, direction NNW.

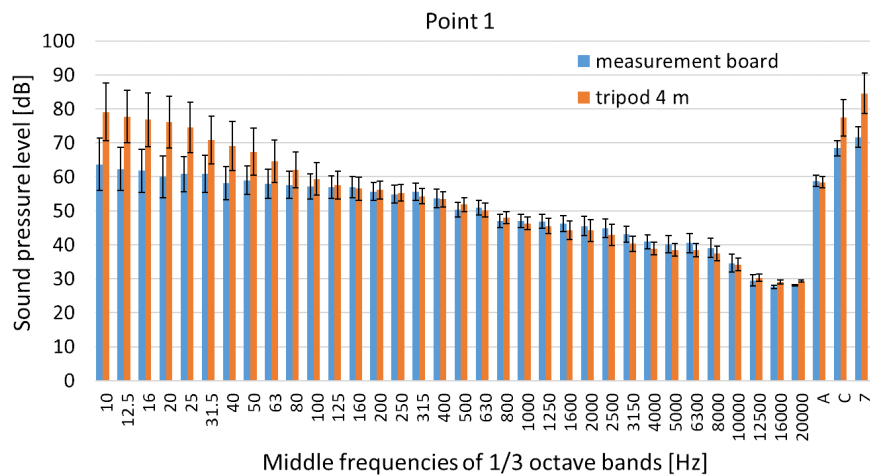

Fig. 8. The results of measurement in point 1 – wind speed 5.4 m/s, direction NNE.

The results recorded at a wind speed of 5.4 m/s and the NNE direction show a very pronounced wind effect on the results at a height of 4 m in the bands below 315 Hz. Significant differences can also be observed in the course of the sound pressure level filtered in the 50–80 Hz band (Fig. 9), although this is not visible in the spectra, as it is probably masked by gusts of wind.

Comparison of spectra in the 1/3 octave bands at points 1, 2, and 3 measured on the board (wind speed 3.8 m/s and NNW direction) is shown in Fig. 10. As can be seen, the well visible tonal component in the 63 and 80 Hz bands, at points 1 and 2, is practically imperceptible at point 3 (from the windward side of the turbine).

Figure 11 shows the frequency-amplitude spectrum realized for a signal with a length of 10 s, which gives a spectral resolution to $df = 0.1$ Hz. In the FFT spectrum one can observe a tonal component for the 66–72 Hz frequency band, which was also visible in 1/3 octave spectra. There are also components for frequencies 206, 245, 300, 399.9, 492 Hz.

Figure 12 shows time plot of the sound pressure level filtered in the band from 290 Hz to 310 Hz. Significant changes in the amplitude of the sound level within 30 s of signal are clearly visible both for the signal measured on the board and for the signal measured on 4 m above the ground.

Analyzing the FFT spectrum for the same wind speed, but from a different time interval (Fig. 13) results show the differences in the occurrence of frequency components. There is no component with the frequency 245 Hz, which was clearly visible in Fig. 11 in the case of measurement on 4 m above ground level.

The measuring point in the residential area was set at a distance of about 410 m in the north-west direction from the nearest located turbine, about 690 m from the turbine tested in this work. The results of the sound pressure level spectrum measurements in the 1/3 octave bands carried out on May 1, 2018, and July 23/24, 2018 (on the day when the tests were carried out at points 1, 2, 3) are shown in Figs 14 and 15.

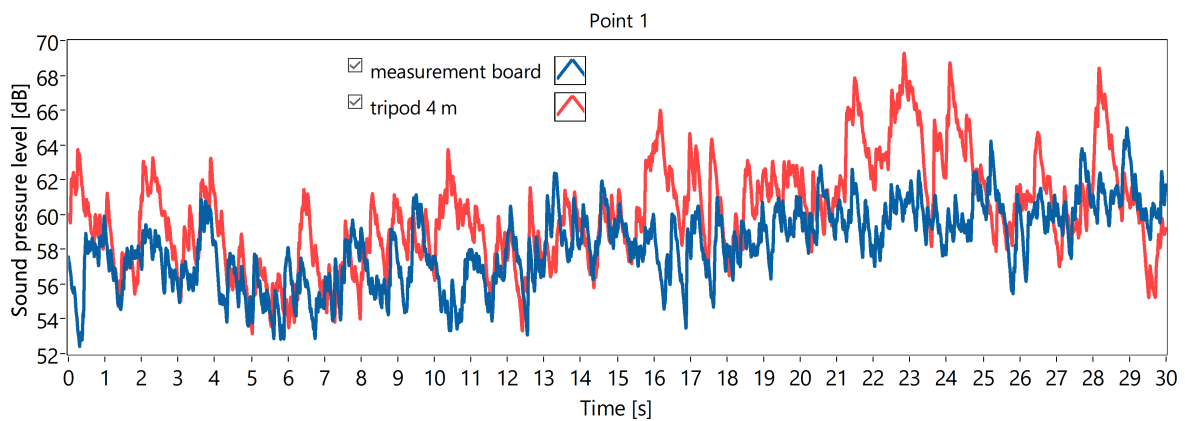

Fig. 9. Time plot of the sound pressure level filtered in the band from 50 Hz to 80 Hz – wind speed 5.4 m/s, direction NNE. Measurement point 1.

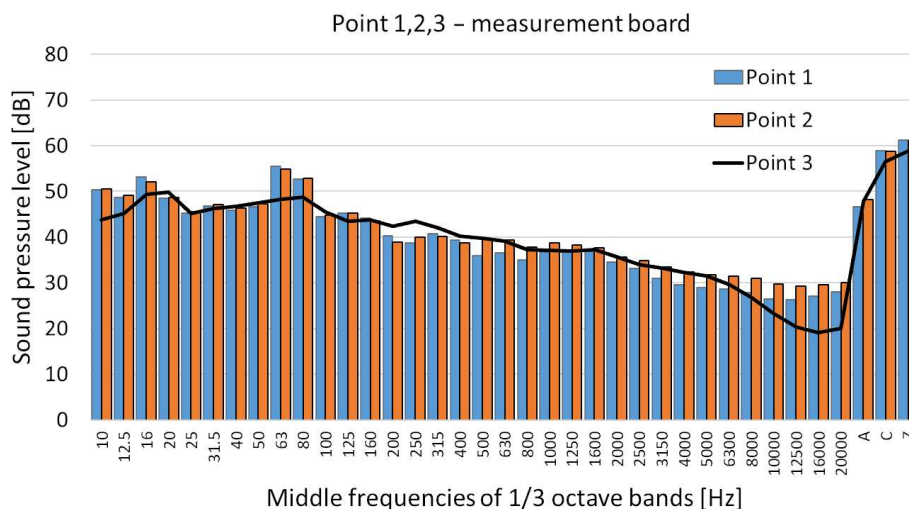

Fig. 10. Comparison of results measured on the board at points 1, 2 and 3 – wind speed 3.8 m/s, direction NNE.

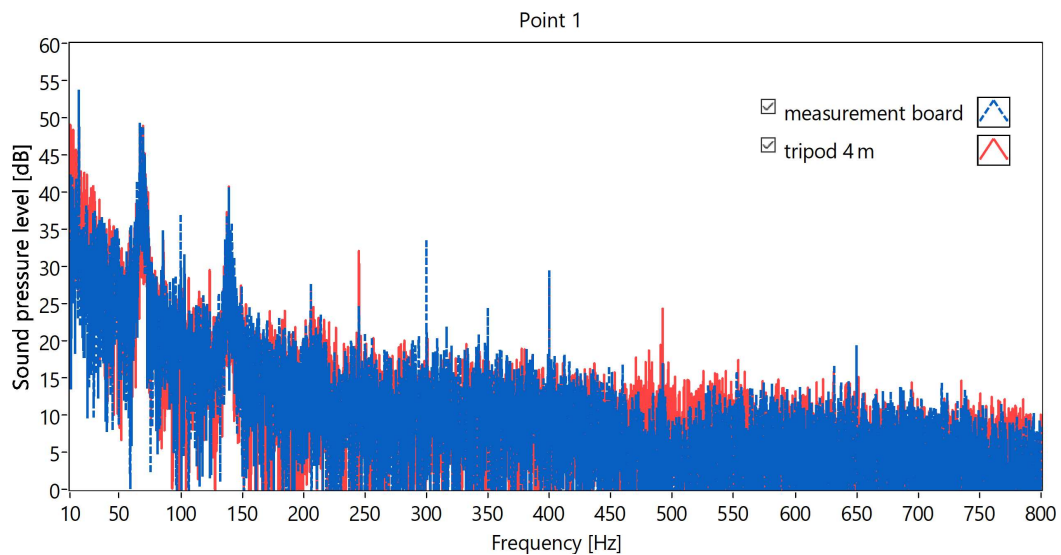

Fig. 11. Amplitude frequency spectrum of the acoustic signal measured in point 1 – wind speed 3.8 m/s, direction NNW.

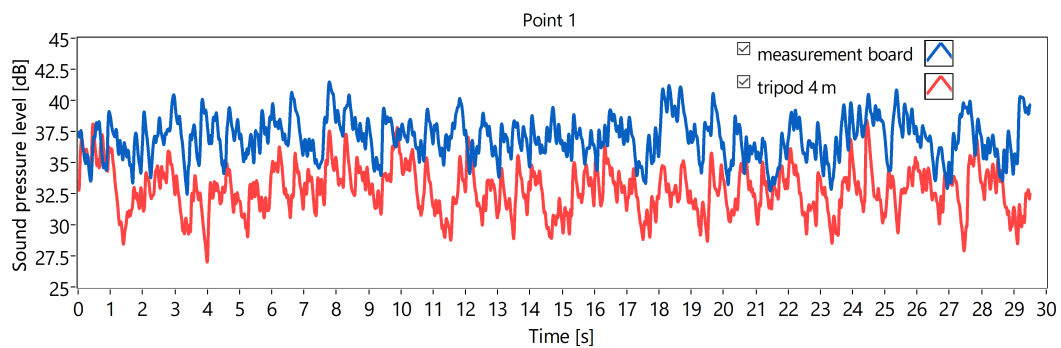

Fig. 12. Time plot of the sound pressure level filtered in the band from 290 Hz to 310 Hz – wind speed wind 3.8 m/s NNW.

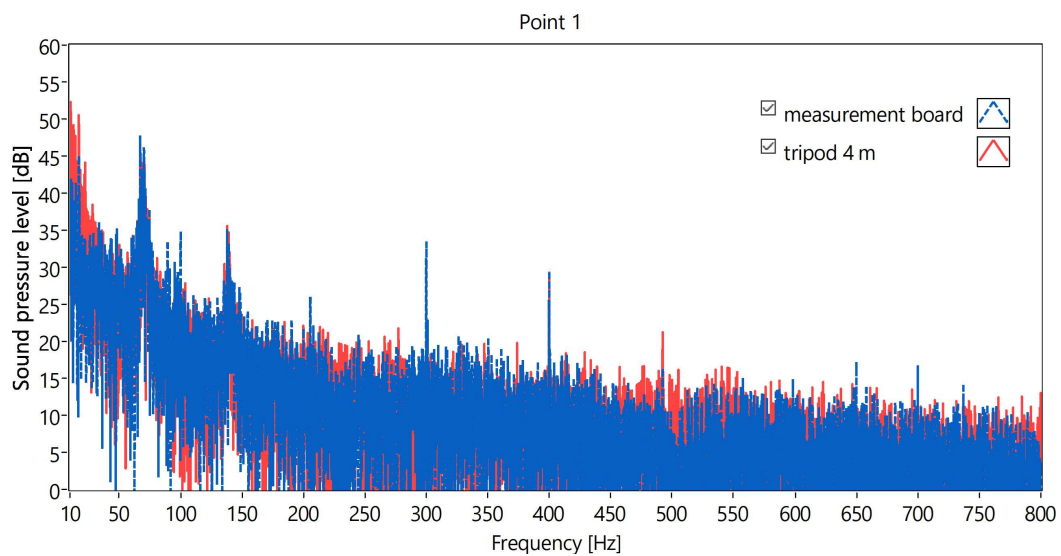

Fig. 13. Amplitude frequency spectrum of the acoustic signal measured in point 1 – wind speed 3.8 m/s, direction NNW.

As can be seen in Fig. 14 there are no characteristic features of the spectrum visible near the turbine, especially the “blurred” 70 Hz component, although the 50 Hz component is clearly visible and the increased

levels in the 1000–1250 Hz bands. The measurement results from May 1 are characterized by other qualities – increased energy in the 160–500 Hz bands, almost completely invisible in the results of 23 July.

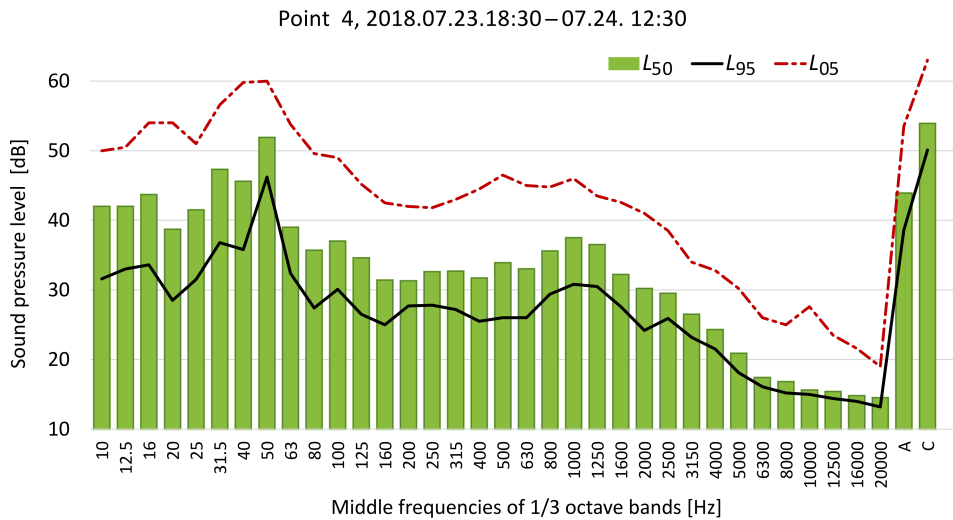

Fig. 14. Statistical spectrum L_{50} , L_{05} and L_{95} in 1/3 octave bands at measurement point in residential area 4 (July 23/24, 2018).

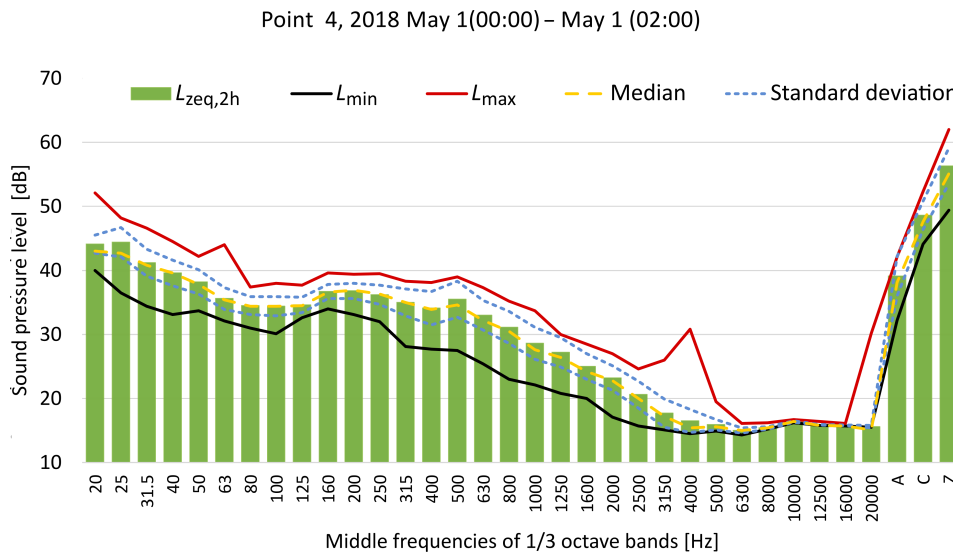

Fig. 15. Statistical spectrum L_{50} , L_{05} and L_{95} in 1/3 octave bands at measurement point in residential area 4 (May 1, 2018).

4. Analysis and evaluation of measurement results on the board and at a height of 4 m above ground level

This section focuses on the comparison of measurement results carried out on the board and on a tripod at a height of 4 m above ground level. A comparison of the weighted levels A, C and Z in points 1 and 2 on the measurement board and at 4 m above the ground, at different wind speeds and directions, are presented in Tables 1, 2, 3, and 4. Due to large random disturbances at measuring point 3, the results made at this point in the following lists are not included. Considering the modulation frequency of noise from the turbine being slightly below 1 Hz (at 15 RPM it will be 0.45 Hz), results dispersion was presented using the standard deviation of levels with the time constant “fast”.

Tables 3 and 4 present the values of sound levels determined for different wind directions for an average wind speed of 2.7 m/s.

On the basis of the collective results shown in Tables 1–4 it is difficult to indicate any relation between the levels measured on the plate and on a tripod at a height of 4 m above the ground level. Although some tendencies are in line with expectations, namely an increase in disturbances in the low frequency range with the wind at higher speeds – Table 1. The difference in $L_{Ceq, 60s}$ level measured on the board in relation to the height of 4 m varies from 1 dB at a wind speed of 1.8 m/s to –9 dB at a wind speed of 5.4 m/s, while the difference in $L_{Aeq, 60s}$ levels is practically constant and is about 1 dB to 0.4 dB. However, in point 2, these differences have different trends.

Table 1. Sound level values for measurements on the board and on a 4 m tripod for different wind speeds, wind direction NNE – measuring point 1.

Parameter	Sound level values for different wind speeds [dB]			
	Wind speed 1.8 m/s	Wind speed 2.4 m/s	Wind speed 3.7 m/s	Wind speed 5.4 m/s
$L_{Aeq, 60s}$ – board	47.2	52.7	53.9	58.8
$\sigma (L_{AF})$ – board	0.9	3.2	2.8	1.6
$L_{Aeq, 60s}$ – tripod	46.2	51.8	53.5	58.4
$\sigma (L_{AF})$ – tripod	0.8	3.2	2.7	1.7
Difference $L_{Aeq, 60s}$ – board – tripod	1.0	0.9	0.4	0.4
$L_{Ceq, 60s}$ – board	57.8	68.3	66.2	68.4
$\sigma (L_{CF})$ – board	1.6	4.6	3.2	2.3
$L_{Ceq, 60s}$ – tripod	56.7	67.0	68.1	77.4
$\sigma (L_{CF})$ – tripod	1.7	4.5	3.0	5.4
Difference $L_{Ceq, 60s}$ – board – tripod	1.1	1.3	-1.9	-9.0
$L_{Zeq, 60s}$ – board	60.5	69.5	67.9	71.8
$\sigma (L_{ZF})$ – board	1.4	4.5	3.2	3.0
$L_{Zeq, 60s}$ – tripod	60.1	69.7	74.0	84.6
$\sigma (L_{ZF})$ – tripod	1.9	4.9	3.4	6.0
Difference $L_{Zeq, 60s}$ – board – tripod	0.4	-0.2	-6.1	-12.8

Table 2. Sound level values for measurements on the board and on a 4 m tripod for different wind speeds, wind direction NNE – measuring point 2.

Parameter	Sound level values for different wind speeds [dB]			
	Wind speed 1.8 m/s	Wind speed 2.4 m/s	Wind speed 3.7 m/s	Wind speed 5.4 m/s
$L_{Aeq, 60s}$ – board	46.4	51.1	53.4	58.6
$\sigma (L_{AF})$ – board	0.8	2.9	2.8	1.6
$L_{Aeq, 60s}$ – tripod	44.8	50.8	52.6	57.2
$\sigma (L_{AF})$ – tripod	0.6	3.3	2.9	1.4
Difference $L_{Aeq, 60s}$ – board – tripod	1.6	0.3	0.8	1.4
$L_{Ceq, 60s}$ – board	57.4	66.8	66.4	68.6
$\sigma (L_{CF})$ – board	1.7	4.5	3.3	2.4
$L_{Ceq, 60s}$ – tripod	60.0	65.4	66.2	73.6
$\sigma (L_{CF})$ – tripod	2.7	4.3	3.3	4.6
Difference $L_{Ceq, 60s}$ – board – tripod	-2.6	1.4	0.2	-5.0
$L_{Zeq, 60s}$ – board	61.8	68.5	68.5	72.6
$\sigma (L_{ZF})$ – board	2.8	4.4	3.5	3.4
$L_{Zeq, 60s}$ – tripod	67.9	69.6	71.3	79.5
$\sigma (L_{ZF})$ – tripod	3.8	4.6	3.6	5.2
Difference $L_{Zeq, 60s}$ – board – tripod	-6.1	-1.1	-2.8	-6.9

Changing the direction of wind at an average speed of approx. 2.7 m/s (Tables 3 and 4) from NW through NNW, N and NNE did not significantly change the differences between the results of measurements made on the board and at a height of 4 m. The differences in A- and C-weighted sound pressure levels in point 2 were higher and slightly more scattered (from 1.6 dBA to

-1.0 dBA and from 1.4 dBC to -2.6 dBC in point 2 and from 1 dBA to -0.1 dBA and from 1.3 dBC to 0.4 dBC in point 1).

In general, larger spreads of results can be expected at higher wind speeds. Although this tendency is visible in the majority of analyzed cases, in point 1 there were deviations from these expectations.

Table 3. Sound level values for measurements on the board and on a 4 m tripod for different wind directions, average wind speed of 2.7 m/s – measuring point 1.

Parameter	Sound level values for different wind directions [dB]			
	Wind direction NW	Wind direction NNW	Wind direction N	Wind direction NNE
$L_{Aeq, 60s}$ – board	46.7	46.4	47.2	52.8
$\sigma(L_{AF})$ – board	0.8	0.8	0.9	3.2
$L_{Aeq, 60s}$ – tripod	45.7	46.5	46.2	51.8
$\sigma(L_{AF})$ – tripod	0.8	1.2	0.8	3.2
Difference $L_{Aeq, 60s}$ – board – tripod	1.0	-0.1	1.0	1.0
$L_{Ceq, 60s}$ – board	59.8	58	57.8	68.3
$\sigma(L_{CF})$ – board	2.1	1.6	1.6	4.6
$L_{Ceq, 60s}$ – tripod	59.1	57.6	56.7	67
$\sigma(L_{CF})$ – tripod	2.3	1.6	1.7	4.5
Difference $L_{Ceq, 60s}$ – board – tripod	0.7	0.4	1.1	1.3
$L_{Zeq, 60s}$ – board	61.7	60.9	60.5	69.6
$\sigma(L_{ZF})$ – board	1.8	1.5	1.4	4.5
$L_{Zeq, 60s}$ – tripod	61.4	61.2	60.2	69.7
$\sigma(L_{ZF})$ – tripod	2.0	1.8	1.9	4.9
Difference $L_{Zeq, 60s}$ – board – tripod	0.3	-0.3	0.3	-0.1

Table 4. Sound level values for measurements on the board and on a 4 m tripod for different wind directions, average wind speed of 2.7 m/s – measuring point 2.

Parameter	Sound level values for different wind speeds [dB]			
	Wind direction NW	Wind direction NNW	Wind direction N	Wind direction NNE
$L_{Aeq, 60s}$ – board	47.8	46.5	46.4	51.2
$\sigma(L_{AF})$ – board	0.8	0.9	0.8	2.9
$L_{Aeq, 60s}$ – tripod	46.5	47.5	44.8	50.8
$\sigma(L_{AF})$ – tripod	1.0	2.2	0.6	3.3
Difference $L_{Aeq, 60s}$ – board – tripod	1.3	-1.0	1.6	0.4
$L_{Ceq, 60s}$ – board	59.3	57.6	57.4	66.8
$\sigma(L_{CF})$ – board	2.1	1.4	1.7	4.5
$L_{Ceq, 60s}$ – tripod	58	56.2	60.0	65.5
$\sigma(L_{CF})$ – tripod	1.9	1.4	2.7	4.3
Difference $L_{Ceq, 60s}$ – board – tripod	1.3	1.4	-2.6	1.3
$L_{Zeq, 60s}$ – board	61.2	60.6	61.8	68.6
$\sigma(L_{ZF})$ – board	1.8	1.4	2.8	4.4
$L_{Zeq, 60s}$ – tripod	62.1	60.3	67.9	69.6
$\sigma(L_{ZF})$ – tripod	2.1	2.1	3.8	4.6
Difference $L_{Zeq, 60s}$ – board – tripod	-0.9	0.3	-6.1	-1

5. Conclusions

The aim of the research conducted at the wind farm in Orzechowce was to analyze the suitability of the measurements made on the board to assess noise at a height of 4 m above ground. To make this assessment possible it seems necessary to find relatively constant relationships between the results at both heights. Un-

fortunately, the results obtained in the surroundings of the tested turbine do not show any useful dependencies. It is possible to find characteristic features in registered results, such as greater susceptibility to wind interference at the measuring point at a height of 4 m above ground, even at acceptable wind speeds (below 5 m/s), but quantitative relations between the results at both heights do not show any trend.

The quality comparison of results looks a little better. The spectra at both heights are very similar and similar tonal features of the spectra can be noticed, that is the occurrence of a tonal component of about 70 Hz. Especially the high similarity of results occurs at low wind speeds below 4 m/s. But in this case, the methodologies allow measurement at a height of 4 m with an ordinary windscreen and there is no need to measure on the measurement board.

Based on the results obtained as part of this work, as well as previous studies, it seems impossible to estimate with satisfactory accuracy the results at a height of 4 m, using measurements at ground level. However, such measurements can be helpful in identifying disturbances from wind gusts.

In the case of low wind speeds, below 5 m/s (at a height of 10 m), the results measured at a height of 4 m, can be used directly to assess the noise. At higher wind speeds, although the results measured on the board show much less sensitivity to disturbances, the quantitative relations between the results at 4 m show too much randomness to be used to estimate noise indicators useful in its quantitative assessment in the environment.

Certainly long-term research results carried out simultaneously in all three points in the surroundings of the turbine, as well as in the residential area, would allow a more accurate examination of these relations, especially in connection with weather data at the hub height and the turbine's electricity output. In order for the results to be more reliable, the tests should be conducted over a longer period of time in a continuous monitoring system in order to exclude various random disturbing phenomena. This, however, is associated with high costs.

Acknowledgments

The project was financed by the Polish Ministry of Science and Higher Education (project No. 16.16.130.942).

References

- EGEDAL R., SØNDERGAARD L.S., HANSEN M.B. (2017), Wind turbine noise at neighbor dwellings, comparing calculations and measurements, [In:] *INTER-NOISE and NOISE-CON Congress and Conference Proceedings*, **255**(2): 5034–5045.
- EN 61400-11:2013, *Wind turbines. Part 11: Acoustic noise measurement techniques* (IEC 61400-11:2012).
- Gamesa G87-2MW (n.d.), <https://en.wind-turbine-models.com/turbines/548-gamesa-g87> (retrieved February 12, 2019).
- GOLEC M., GOLEC Z., CEMPEL C. (2006), Noise of wind power turbine VESTAS V80 in a farm operation, *Diagnostyka* 1 (37)/2006.
- HANSEN K., ZAJAMSEK B., HANSEN C. (2013), Evaluation of secondary windshield designs for outdoor measurement of low frequency noise infrasound, *5th International Conference on Wind Turbine Noise*, Denver, August 28–30, 2013 (CD).
- ISO 1996-2:2017, *Acoustics – Description, measurement and assessment of environmental noise – Part 2: Determination of sound pressure levels*.
- Journal of Laws (2008), Regulation of the Minister of Environment of 4 November 2008 on requirements in scope of carrying out measurements of emissions and measurements of water intake, *Journal of Laws* 2008, No. 206, item 1291.
- KENDRICK P., VON HÜNERBEIN S., COX T.J. (2016), The effect of microphone wind noise on the amplitude modulation of wind turbine noise and its mitigation, *The Journal of the Acoustical Society of America*, **140**(1): EL79–EL83, doi: 10.1121/1.4955010.
- KŁACZYŃSKI M., WSZOLEK T. (2014), Acoustic study of repower MM92 wind turbines during exploitation, *Archives of Acoustics*, **39**(1): 3–10.
- KORBIEL T. et al. (2017), Recognition of the 24-hour noise exposure of a human, *Archives of Acoustics*, **42**(4): 601–607, doi: 10.1515/aoa-2017-0064.
- LARGE S., STIGWOOD D., STIGWOOD M. (2017), Cotton Farm Wind Farm long term community noise monitoring 4 years on: testing compliance and AM control methods, [In:] *INTER-NOISE and NOISE-CON Congress and Conference Proceedings*, **255**(3): 4844–4854.
- MCCABE J.N. (2011), Detection and qualification on amplitude modulation in wind turbine noise, *Fourth International Meeting on Wind Turbine Noise*.
- PAULRAJ T., VÄLISUO P. (2017), Effect of wind speed and wind direction on amplitude modulation of wind turbine noise, *Inter Noise 2017*, August 27–30, 2017, Honk Kong (CD).
- PLEBAN D., RADOSZ J. (2015), Noise emitted by a wind turbine during operation [in Polish], *Rynek Energii*, **2015**(3): 109–114.
- TASHIBANA H., YANO H., FUKUSHIMA A. (2013), Assessment of wind turbine noise in immission areas, *5th International Conference on Wind Turbine Noise*, Denver, August 28–30, 2013 (CD).
- VAN DEN BERG G.P. (2004), Effects of the wind profile at night on the wind turbine sound, *Journal of Sound and Vibration*, **277**(4–5): 955–970, doi: 10.1016/j.jsv.2003.09.050.
- WSZOLEK T., KŁACZYŃSKI M. (2014), Problems in measurements of noise indicators for Wind Turbine in Poland, *Forum Acusticum*, Krakow, Poland.
- WSZOLEK T., KŁACZYŃSKI M., MLECZKO D. (2014a), Effect of acoustic model input parameters to the range of wind turbine noise, *Proceedings of Forum Acusticum*.
- WSZOLEK T., KŁACZYŃSKI M., MLECZKO D., OZGA A. (2014b), On certain problems concerning environmental impact assessment of wind turbines in scope of acoustic effects, *Acta Physica Polonica A*, **125**(4A): A-38–A-44, doi: 10.12693/APhysPolA.125.A-38.