

INITIATION OF ROTATING DETONATION IN EXPERIMENTAL COMBUSTION CHAMBER – PRACTICAL REALIZATION

Michał Kawalec, Witold Perkowski, Andrzej Irzycki
Krzysztof Snopkiewicz, Wiesław Wróblewski, Adam Bilar, Borys Łukasik

Institute of Aviation
Krakowska Av. 110/114, 02-256 Warszawa
tel.: +48 22 8460011 w 618, fax: +48 8465774
e-mail: michal.kawalec@ilot.edu.pl

Abstract

Since 2009 in the Institute of Aviation, Warsaw a project that aim is to develop combustion chamber with rotating detonation for turbine engine has been carried out. Desired fuel is aviation kerosene (Jet-A) detonated in air. One of the most important problems to be solved was the initiation of rotating detonation in combustible mixture, which requires the fulfilment of several conditions:

- 1) good mixing of combustible mixture components,
- 2) properly fast flow of combustible mixture in the cylinder-shaped channel,
- 3) the appropriate height of the flow channel, associated with detonation cell size for the combustible mixture,
- 4) use of a source of detonation initiation with an appropriate energy and power for a given combustible mixture.

There were considered and tested, in practice several different types of initiators:

- a) spark electric discharge in air,
- b) plasma electric discharge (the so-called "exploding wire"),
- c) micro-explosive charges,
- d) blank ammunition,
- e) gas initiator (with detonation of acetylene-oxygen stoichiometric mixture induced by spark electric discharge).

The paper summarizes the theoretical energy parameters of several types of initiators, and the results of their comparative research on the test bench. In the course of these researches, the pressures of the shock wave generated by the initiators and recorded by a fast pressure sensor located at a distance from the initiator were compared.

Keywords: engines, shock wave, shock tube, pressure measurements

1. Introduction

Taking into account the energy of the initiator (which should be as large as possible), as well as practical considerations associated with initiator service, for the purpose of comparative tests the 3 initiator was chose: a high pressure acetylene-oxygen, with membrane; a low pressure oxygen-acetylene, without membrane; and pyrotechnic (which uses blank ammunition). All three initiators operate on the same principle: generate a shock wave. Comparative tests consisted in measuring the parameters of the generated shock wave (pressure, velocity) at a certain, fixed distance from the initiator. In order to conduct such tests a special test stand was constructed.

2. Object of comparison tests

2.1. High Pressure Initiator (HPI)

The initiator design scheme is shown in Fig. 1. The principle of operation is as follows: the initiator chamber, closed with a plastic membrane (Fig. 1 – a thick red line), after pumping air out with a vacuum pump is filled to a predetermined pressure with a previously prepared mixture of the stoichiometric oxygen-acetylene. The initiator was started up by detonation of the mixture inside the initiator chamber using spark plug discharge (in the initiator cylinder head). Generated

in this way, the shock wave breaks the membrane and flies out of the "barrel" of the initiator. The energy of the initiator depends on the pressure of mixture in the chamber. Every single shot of the initiator requires installing a new membrane. –

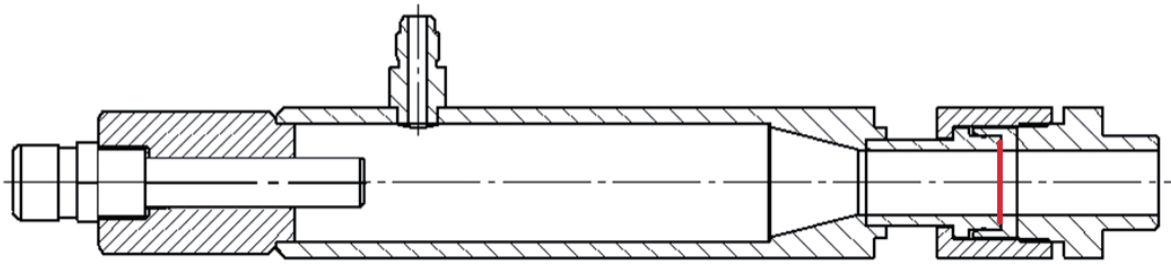

Fig. 1. High Pressure Initiator

2.2. Low Pressure Initiator (LPI)

The initiator design scheme is shown in Fig. 2. The operation of the initiator is as follows: the chamber, which was initially filled with air (before the first shot) or a mixture of air and combustion products of acetylene-oxygen mixture (with subsequent shots), is filled with a stoichiometric mixture of acetylene-oxygen. Using a slight overpressure, a portion of the mixture, corresponding to the volume of the chamber, is pumped into the chamber. Starting the initiator consists in the mixture detonation using spark discharge (spark plug in the cylinder head of the initiator). Generated shock wave flies out from an initiator "barrel". Then, the gases (combustion products) fly out from the initiator, generating outside the initiator another shock wave. The initiator is more practical to use than the initiator equipped with a membrane HPI, since there is no need to replace the membrane before each shot.

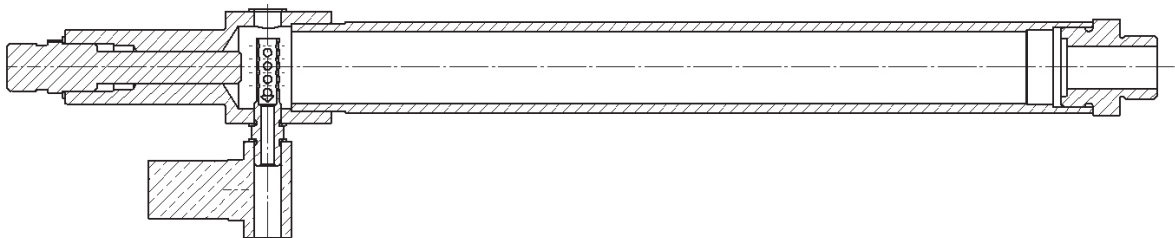

Fig. 2. Low Pressure Initiator

Basic parameters of the LPI:

- Chamber volume – 180 cm³,
- Diameter of the pipe ("barrel" outlet diameter) 16 mm,
- Calorific value of the compressed mixture: 2.8 kJ respectively for absolute pressure of the mixture of at 1 bar.

2.3. Blank Ammunition Initiator (BAI)

The blank ammunition initiator of design scheme is shown in Fig. 3. This type of initiator uses the 0.22" blank, ammunition. Principle of operation of the initiator follows the pattern: blank ammunition is placed in the chamber and bolted through the head that contains two electrodes that have contact with the primer. The electrodes are connected by controlled contactor, with a current source (12V car battery). The initiator starts when the circuit is closed with the contactor, which causes primer explosion (after about 200 ms), which in turn initiates the (explosive) combustion of

powder charge contained in the cartridge. As a result, formed hot gases expand rapidly in the short initiator barrel, generating in ambient air, a spherical shock wave.

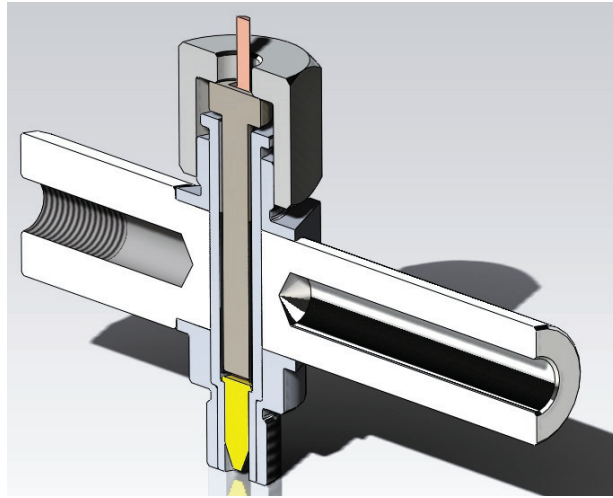

Fig. 3. Blank Ammunition Initiator

Basic parameters of the BAI:

- diameter of the pipe ("barrel" outlet diameter) 5.6 mm,
- the estimated energy of the explosive charge – 0.48 kJ (for a weighed amount of powder 0.15 g and its assumed and typical composition).

3. The test stand and measuring system

The test stand has a form of a tube with dimensions of 35 mm and a length of 1060 mm, in which pressure sensors (socket K1 and K2) are located. Sensors slots are located successively 400 mm and 990 mm from the initiator barrel outlet.

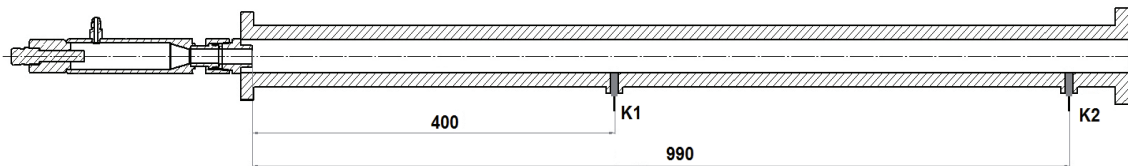

Fig. 4. The test stand scheme with measuring sensors (K1, K2) mounted

Tab. 1. Characteristics of the measuring system

Lp	Parameter	Sensor	Amplifier	Data acquisitioncard DAQ
K1	Pressure	Quartz piezoelectric KISTLER 603B (range0-200bar)	Kistler 5018A1000	NI-USB 6366 (fast f=2MHz)
K2	Pressure	Quartz piezoelectric KISTLER 603B (range0-200bar)	Kistler 5018A1000	NI-USB 6366 (fast f=2MHz)

4. Experiments and results

Tests of initiators were carried out at the test stand. A series of tests for the blank ammunition initiator and for the two initiators with the acetylene-oxygen mixture (HPI and LPI) were

performed. It is assumed that the initiator efficiency is a magnitude of the pressure increase in the generated shock wave compared to the energy of the initiator.

Jumps of pressure in the shock wave were recorded at two distances from the initiator. This made it possible to estimate the average speed of the generated shock wave. Recorded pressure peaks magnitude in the shock wave were confronted with theoretical, that result from the velocity of shock wave. This made it possible to develop idealized course of pressure, free from noise that is generated in the real measuring system. These noises are the vibration and tension in sensors holders induced by shock waves. That is so called effect of “sensor ringing” [1] that causes nonphysical sensor indications.

Figure 5-9 show pressure course records by K1 and K2 sensors (Fig. 4) with idealized course of pressure drew on them. Idealized pressure courses were created in the way that the line of averaged pressure drop behind the shock wave (parabolic) was extended to the intersection with the vertical line of pressure jump in the shock wave. In such a way, predictable value of maximum pressure in the shock wave was received. It is shown in Tab. 2.

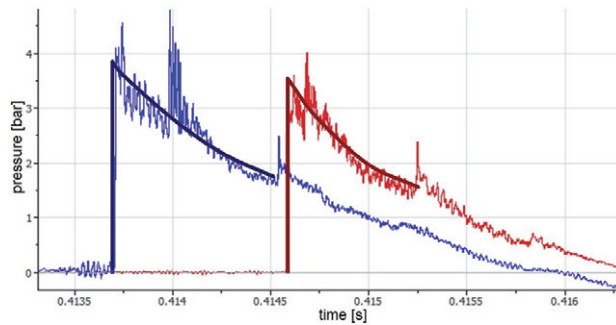

Fig. 5. Low Pressure Initiator (test no. 20)

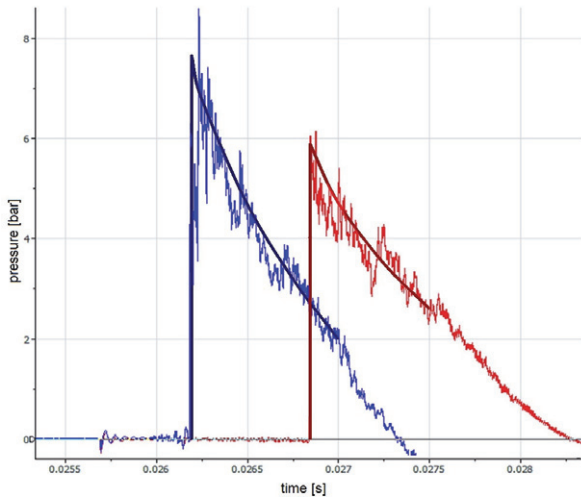

Fig. 6. High Pressure Initiator – pressure 3 bar (test no. 30a)

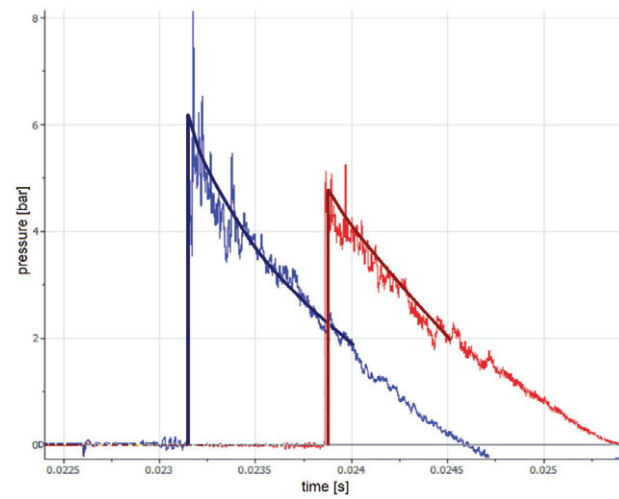

Fig. 7. High Pressure Initiator – pressure 2 bar (test no. 31a)

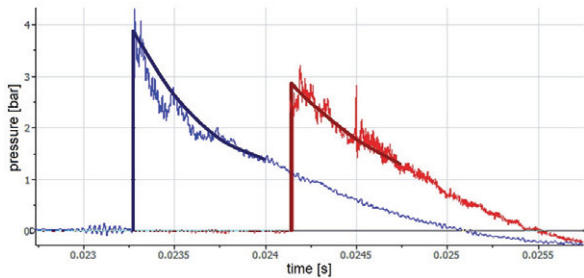

Fig. 8. Pressure Initiator – pressure 1 bar (test no. 32)

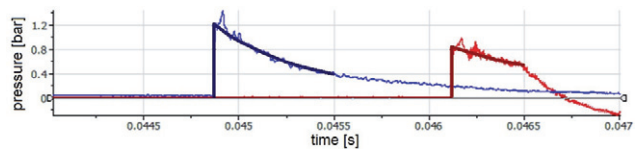

Fig. 9. Blank Ammunition Initiator (test no. 40b)

Using the formula for the dependence of the shock wave and pressure behind it [5]:

$$\frac{p_2}{p_1} = 1 + \frac{2k}{k+1}(M_s^2 - 1), \quad (1)$$

assuming that the speed of sound: $a = \sqrt{kRT} = \sqrt{1.4 \cdot 287 \cdot 293} = 343 \text{ m/s}$.

The following parameters were obtained in tests [Tab. 2]

Tab. 2. Parameters obtained i tests

		Distance between transducers = 0.59 m						
Test no.	Initiator type	Time between pressure peaks [ms]	Shock wawe average Velocity [m/s]	Shock wawe Mach number Ms	Calculated pressure peak [bar]	Measured pressure peak K1 [bar]	Measured pressure peak K2 [bar]	Mean of pressure peaks [bar]
20	LPI	85.2	692.5	2.02	4.590	4.7	4.4	4.55
20a	LPI	90.1	654.8	1.91	4.086	4.6	3.55	4.075
30	HPI-3 bar	64.5	914.7	2.67	8.133	8.5	6.9	8.1
30a	HPI-3 bar	66.1	892.6	2.60	7.736	8.6	6.85	7.725
31	HPI-2 bar	71.2	828.7	2.42	6.644	7.1	5.8	6.45
31a	HPI-2 bar	70.7	834.5	2.43	6.741	7.2	5.8	6.5
32	HPI-1 bar	87.4	673.5	1.96	4.354	4.85	3.85	4.35
32b	HPI-1 bar	87.4	675.1	1.97	4.353	4.7	3.7	4.2
40	BAI	121	487.6	1.42	2.191	2.05	1.87	1.96
40a	BAI	123	479.7	1.40	2.115	2.1	1.604	1.852
40b	BAI	125	472	1.38	2.043	2.23	1.85	2.04

HPI initiator is completely filled with a well-defined quantity of a mixture of acetylene-oxygen – very flammable and prone to detonation [2]. It can be assumed that combustion in the initiator is practically complete. For these reasons, we assumed that it is our “ideal” initiator and is a reference point for other initiators. Fig. 10. shows a comparison of the effectiveness of the tested initiators. The continuous line mark the extrapolated curve of initiator efficiency for our “ideal” initiator (HPI).

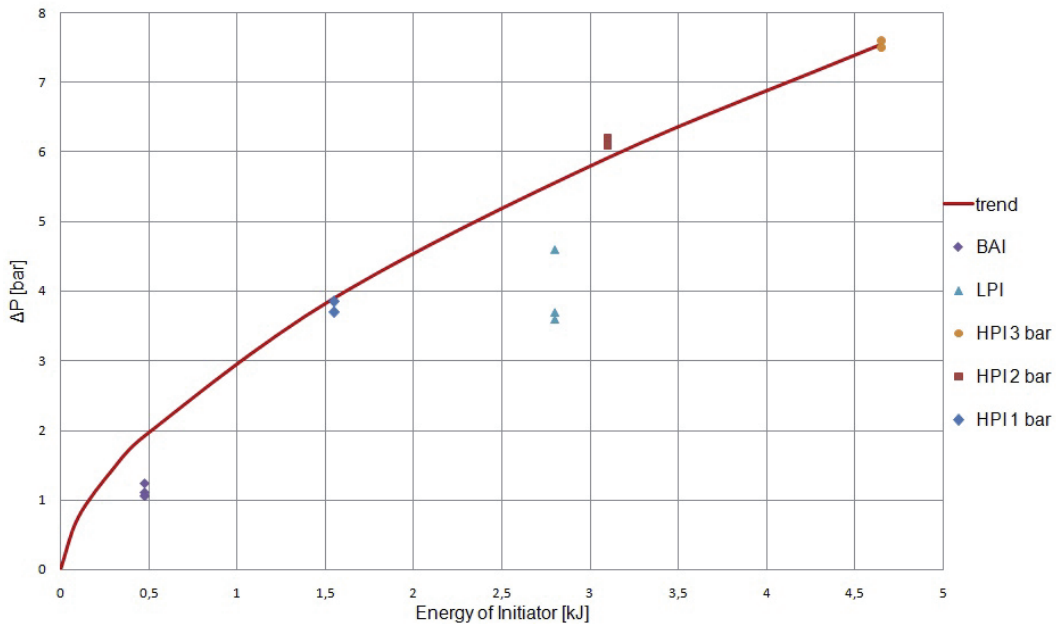

Fig. 6. Comparison of the effectiveness of tested initiators. ΔP is a difference between pressure before and behind Shock wave

Pressure in the shock wave caused by the initiator BAI is approximately two times lower than predicted for comparative HPI initiator of the same energy. This is probably due to the fact that the entire load was not burned, as well as some of the energy was absorbed in the deformation of the hull. Pressure in the shock wave generated by the initiator of the LPI is on average about 30% less than expected for the initiator HPI with the same energy. The reason is probably that the chamber of initiator is filled with the not homogenous, stoichiometric mixture – Part of the combustible mixture comes out of the chamber and the chamber of the initiator is filled with a mixture of acetylene, air and oxygen. For the same reason, LPI initiator is much less repeatable than HPI.

5. Summary and conclusions

1. During the measurements "sensors ringing effect" occurred. It was associated with the vibration of the sensors holders that was generated by the shock wave. The problem of these noises was solved by introducing approximate averages of recorded pressure course. This made it possible to obtain satisfactory compatibility between the "peaks" of pressure and the measured speed of the shock wave.
2. The most effective initiator was found to be the HPI initiator (acetylene-oxygen with membrane). The LPI initiator efficiency was about 30% less and the BAI initiator about 50% less.
3. The Comparative tests of initiators were carried out by "shooting" in the tube, which had the same set of sensors in the all tests. Every shot caused a planar or a quasi-planar shock wave transition that was recorded by the sensors [3]. In these tests the sensors arrangement was crucial. They cannot be too close to the initiator because the shock wave must have a "run-up" to be fully formed [4]. In case of the initiator with the membrane there was also a need to deal with two shock waves (not to mention about possibly reflected waves) – after the first wave, which tears the membrane, follows the second one, generated by the expanding gases, which at some point catches up the first wave.

References

- [1] Curchack, H. D., Davis, H. J., *Shock Tube Techniques and Instrumentation*, Harry Diamond Laboratories, Report TR-1429, March 1969.
- [2] Revsin, A. F., *Mechanism of acetylene-chlorine mixture explosion initiated by small additions of oxygen*, International Journal of Chemical Kinetics, Vol. 15, Is. 1, pp. 1-4, January 1983.
- [3] Jagadeesh, G., *Fascinating World of Shock Waves*, Resonance, August 2008.
- [4] Bauer, F., *Pvdf shock compression sensors in shock waves*, Institut Franco-Allemand de Recherches de Saint-Louis, (ISL), 68301 Saint-Louis France physics McGraw-Hill, *Dictionary of Aviation*, McGraw-Hill Companies, Inc.
- [5] Bukowski, J., *Mechanika Płynów*, Państwowe Wydawnictwo Naukowe, Warszawa 1959.