

REVERSE IIR FILTER AS A TOOL FOR CYLINDER INDICATING CHANNEL PATENCY IMPACT CORRECTION ON MEASURED CYLINDER PRESSURE WAVEFORM

Marek Łutowicz

Naval Academy in Gdynia, Department Mechanical-Electrical Engineering

Śmidowicza Street 69, 81-103 Gdynia, Poland

tel.: +48 58 626 26 17

e-mail: marek@unitest.pl

Abstract

Indicating of large marine and industrial diesel engines is made with using indicating channels in cylinder head with valves. The impact of these channels on the value of the parameters obtained from indicating is significant. However, indicating is commonly used for comparative tests assuming that this error is the same on all cylinders of the same engine in identical conditions. As a result of operation especially in cylinders with irregular combustion process the coke occurs in the channel limits its patency. It causes changes in the image of indicated pressure. In such a situation defined parameters are subject of considerable random error. In the earlier studies on the engine Sulzer type 6AL20/24 cylinder channel failure was simulated and channel choking symptom was observed as apparent TDC shift relative to a reference mark connected with the shaft. As part of ongoing studies attempt to reconstruct distorted pressure curve by choked indicating channel was made. It is assumed that the channel with the valve is only connection between throttling element in the form of a channel with the much greater volume of the valve. Such a structure was modeled as IIR filter. For this type of filter, there is an unequivocal inverse transformation, which, at least in theory gives possibility to reconstruct the distorted pressure waveform. The reconstruction was carried out by selection of the filter coefficients so as to eliminate the shift of TDC. In practice it turned out that the reconstruction is not perfect. All obtained pressure waveforms are slightly noisy and distorted in the first phase of expansion. Despite this, there was a significant reduction in errors of some parameters determined from the reconstructed pressure waveform.

Keywords: marine diesel engine, indicated, indicated channel, diagnostics

1. Introduction

One of the basic methods of controlling the correct operation of the internal combustion engine is to evaluate the quality of the combustion process. This evaluation is carried out, inter alia, based on the analysis of pressure in the engine cylinder. During studies in the Institute of Ship Construction and Maintenance of the Polish Naval Academy indicating tests on all engines of the Polish Navy were carried out. Also indicating tests on motor-compressors for gas compressor stations were done. Including the indication tests on total amount of 136 cylinders it was found that five of indicator valves were completely occluded due to obstruction of channels by soot deposits. It is alleged that in the case of the other channels, despite not total channels obstruction observed their partial choking and atresia may have occurred. Perhaps these failures could affect the reliability of the measurements taken. Channel fouling phenomenon has become troublesome when installation for continuous monitoring for motor-compressors type GMVH have been built and operated on one of the gas compressor plant. In operation of the monitoring system channels polluted after some time, causing throttling [5]. An example of the effect caused by the progressive choking of the channel is shown in Fig. 1.

During operation of that system it was found that channel choking:

- occurs more frequently than any other defect,
- measurements made in accordance with the methodology does not provide reliable information about the state of the machine,
- introduces unnecessary anxiety,
- symptom is indicator diagram offset relative to TDC.

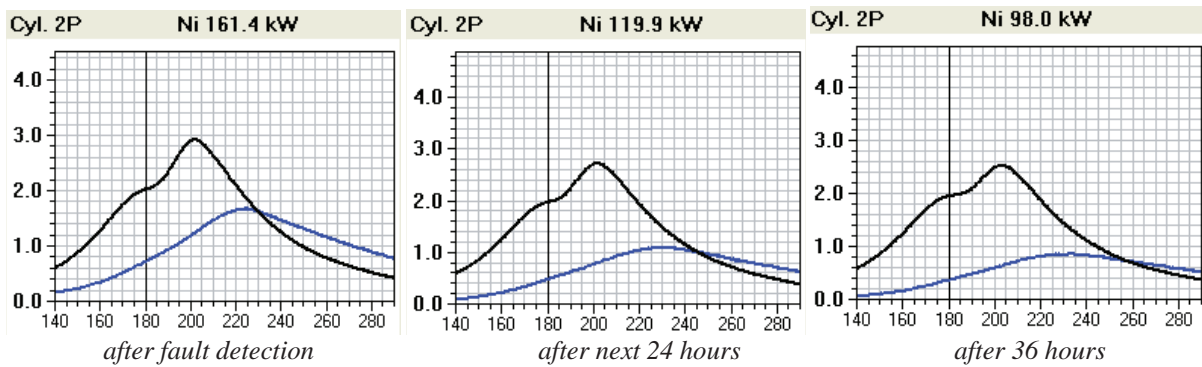

Fig. 1. Image of cylinder pressure deformed graph on the cylinder with carbon deposits in the indicating channel on the background of the average pressure graph of remaining cylinders

The fact of indicator diagram shift is used for signalling channel fouling. However, until the intervention of the service system should continue to fulfil its role and support operational decision making. For this purpose the ability to reconstruct the signal distorted by a partially obstructed channel is recommended.

2. The measuring stand

Due to the universal nature of the phenomenon and the desire to use these algorithms in the diagnosis of marine engines, tests were carried out on a laboratory engine Sulzer type 6AL20/24 in the laboratory of the Institute of Ships Construction and Maintenance. Engine on the test bead was equipped with indicating valve channels, as shown in Fig. 2.

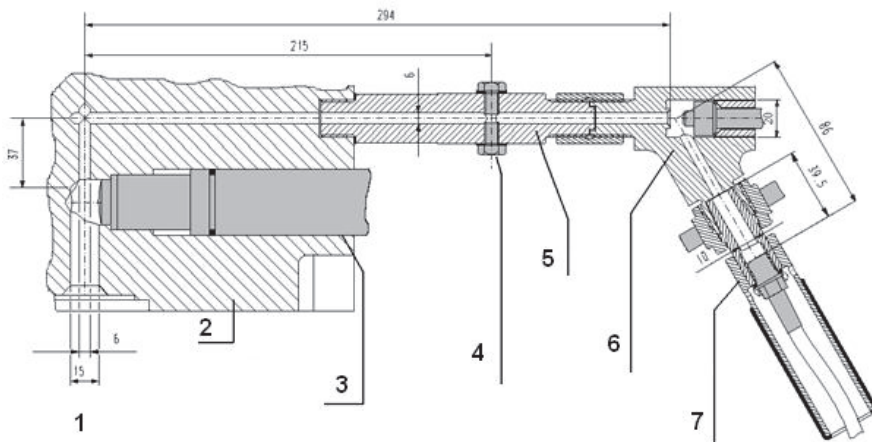

Fig. 2. The SULZER diesel engine type 6AL20/24 indicating channel (1- combustion chamber, 2-cylinder head, 3-starting valve channel, 4- screws added to chocking/throttling gas stream during the experiment tests, 5-union piece, 6- indicating valve, 7- Thompson adapter with pressure sensor)

An indicator channel of Sulzer engine type 6AL20/24 in the proximal segment has diameter of 15mm passing hereinafter in 6 mm diameter with 331 mm in length. At the end of the channel a space (volume) is located in which the valve head moves plus the canal connecting the space with a conical sensors slot. During operation, if conditions for the formation of carbon deposits occur, open channel diameter decreases.

3. Tests on the laboratory stand

In order to simulate the channel fouling due to carbonization in the coupling between the engine block and valve threaded hole was made perpendicular to the axis of the channel in which

the bolts throttled gases stream was screwed into. In this study a screw-bolts screwing into was limited to such position that after the valve opening the gas flow to take place and the accompanying sound effect not disappeared. That brought to that maximum gas flow suppression, which did not give any symptoms yet possible to organoleptic statement.

Measurements were performed using electronic analyser MA2009 manufactured in the Polish Naval Academy in Gdynia equipped with a sensor KISTLER 7613. Measurements of the throttling impact were performed with a fixed combination of adjusting screws. During the measurements only the engine load has been changed. Reference measurements without throttling have been performed just before setting the throttle, next artificial throttling was introduced and the measurement was repeated without changing other conditions of measurement.

Pressure waveforms obtained during the measurements were synchronized by reference mark. As a reference mark envelope vibration signal from injector was used [1]. Because it is an engine with a constant fuel injection start angle, and the measurements were performed only on one cylinder at constant load conditions that marker has enabled overlapping pressure runs with and without throttling. An example of the effect of such imposition is shown in Fig. 3.

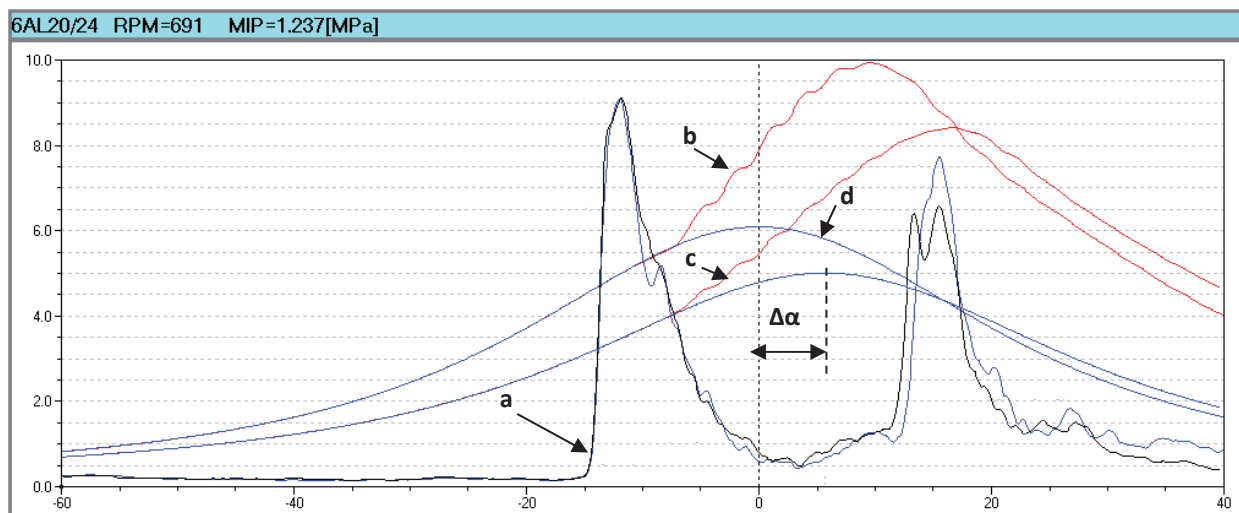

Fig. 3. An example of an indicator diagram with channel choking on a graph without choking and the TDC set by reference mark: a- the vibration pulse from the opening of the injector, b- pressure course without throttling, c- pressure course with throttling, d- extrapolations of compression curves, $\Delta\alpha$ - TDC shift induced by throttling

To carry out the reconstruction of pressure waveform distorted through a channel a model of the channel should be create. Due to the bending's, changes in diameter, the spaces around the front of the head of the sensor and temperature changes, accurate modeling of the channel is difficult. In the preliminary discussion, the channel model is taken as a volume connected to the cylinder via a throttle element. It is a typical inertial module of the I-st order possible to describe as the simplest low-pass filter.

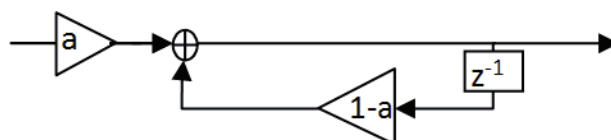

Fig. 4. The IIR filter structure - the simplest channel model

This model is an oversimplification, but the main advantage is that it has only one coefficient. By changing this coefficient the throttling effect is chosen so as to achieve similar to the real throttle. Example of using the model is shown in Fig. 5.

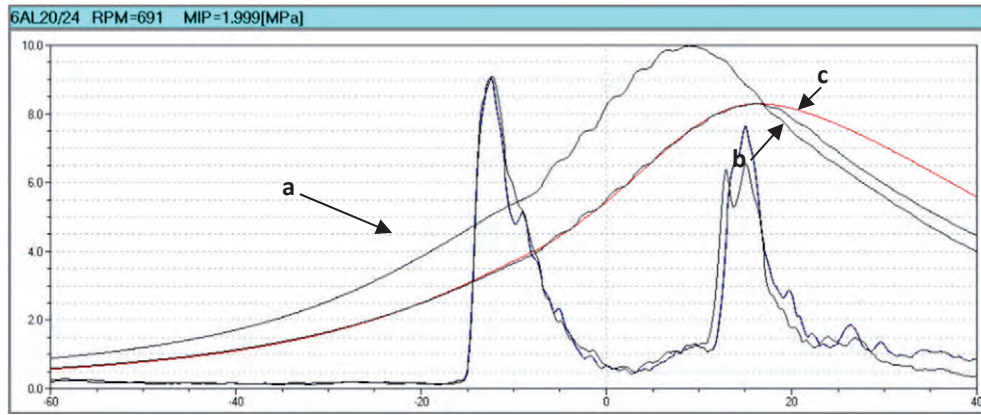

Fig. 5. Test of the IIR filter as a model of indicating channel choking: *a* – pressure course measured without throttling, *b* - pressure course measured with throttling of the channel, *c* - the course *a* after the filter with coefficient $a = 0.0078$

It was found that the course without throttling (*a*) is deformed to form (*c*), so that in the part of compression and combustion pressure course until the maximum pressure coincides with the measured pressure course with throttling of the channel (*b*). Later in the course the model curve does not coincide with the measured. This model is not taking into account the phenomena of resonance and because of this deviates from perfection. However, this model due to only one coefficient, good reflects of compression curve and ease reversal was used to reconstruct the pressure waveform obtained from the choked channel. Pressure course obtained from a simple model reversal at the same coefficient $a = 0.0078$ is shown in Fig. 6.

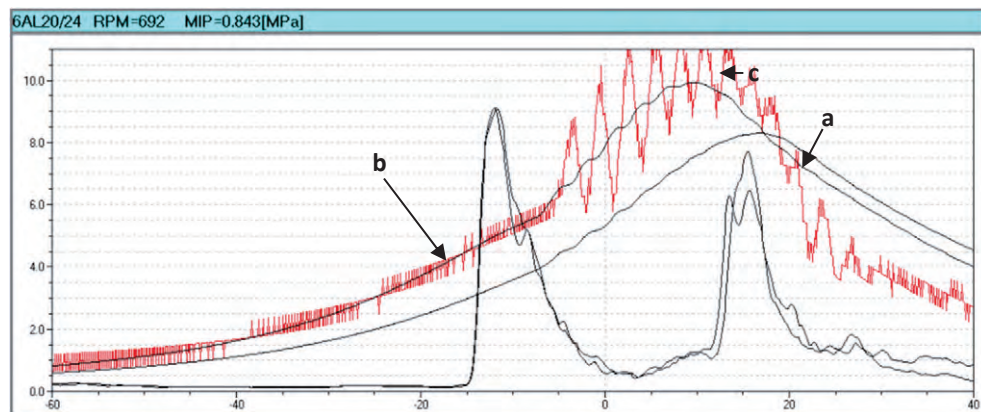

Fig. 6. An example of the pressure curve reconstruction: *a* – pressure curve measured without throttling, *b* - pressure curve measured with throttling of the channel, *c* - *b* pressure curve after reconstruction

This curve is noisy and discontinuous. This is due to the emphasis on the noise and discretization errors that the 12-bit converter started controlling the shape of the reconstructed waveform. To correct an error of discretization the table with the results of measurements of Integer type was transformed into a Real type and subjected to filtering. As the filter a movable approximation has been used [6]. Results of another reconstruction of the course which has undergone filtration are shown in Fig. 7.

The resulting compression process curve is quite smooth. Compression pressure and TDC can be determined from it by extrapolation [5]. By changing the filter coefficient one should lead to a condition such that the TDC determination error in comparison with the TDC designated by the reference mark $\Delta\alpha$ reached value 0. Then in the compression process model and reconstructed courses are similar. However in the course of combustion reconstructed curve have waves with frequency equal resonance frequency of the indicating channel. Due these waves to read the maximum pressure P_{\max} and $\alpha_{P_{\max}}$ is impossible. After the reconstruction of the course the

frequency of these oscillations was found and deleted by using the band-stop filter. The effect of waveform reconstruction with filtering of these waves is shown in Fig. 8.

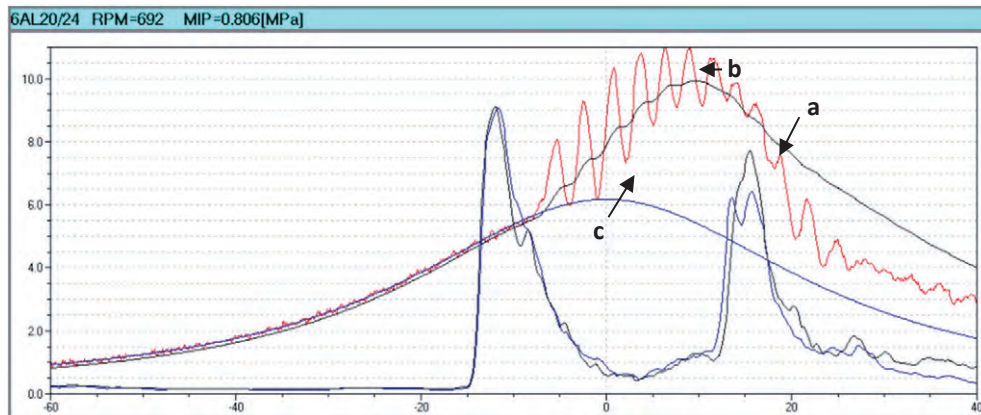

Fig. 7. Result of reconstruction of the course which has undergone filtration: a - pressure curve measured without throttling, b - the pressure curve after the reconstruction of the choked course, c - extrapolation of the compression process from the reconstructed course

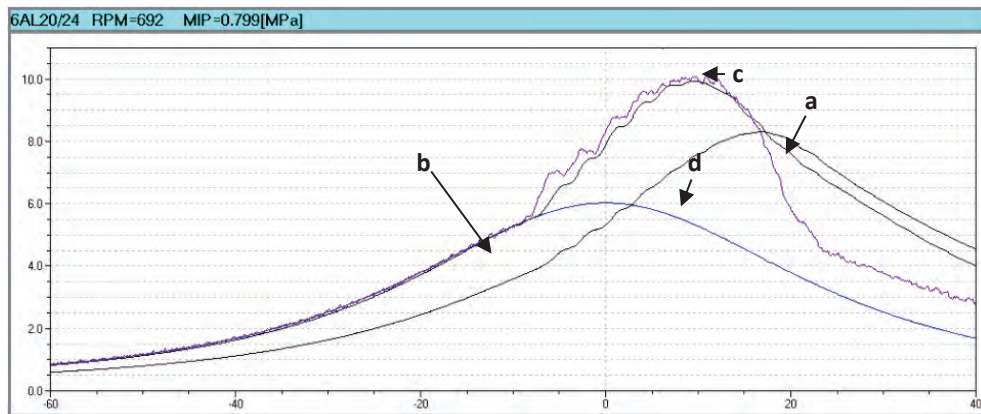

Fig. 8. The end result of the reconstruction: a – pressure curve measured without throttling, b - the pressure course of the throttled channel, c - the pressure course after the reconstruction from the course b, d - extrapolation of the compression process from the reconstructed course c

A similar effect of a reconstruction of the course was achieved at engine speed of 500 rpm. With such a reconstructed waveform set of basic parameters was read out from the indicator diagrams. These are presented in Tab. 1.

Tab. 1. Summary of parameter's values read out from a patent channel, throttled and throttled after reconstruction

RPM	Type of measurement	P_{comp}		P_{max}		α_{Pmax}		MIP	
		[MPa]	δ [%]	[MPa]	δ [%]	[deg]	Δ [deg]	[MPa]	δ [%]
692	patent channel	6.09		9.94		9.6		1.236	
	throttled channel	3.96	-35	8.31	-16.4	16.2	6.6	1.661	34.4
	reconstruction	6.03	-0.98	10.02	2.6	9.2	-0.4	0.799	-35.4
507	patent channel	3.43		6.78		7.8		0.713	
	throttled channel	2.52	-27	5.72	-15,6	14.1	6.3	0.949	33.1
	reconstruction	3.43	0	6.61	-2.5	8.1	0.3	0.567	-20.5

4. Verification on the real object

Acting in accordance with the approved indicating methodology of Sulzer engine type 6AL25/30 which is use as a main drive on one of the ships of the Polish Navy reduced compression pressure, earlier fuel injection and earlier spontaneous combustion in the cylinder 6 were found. Pressure waveform and envelope of vibration in bar graph of obtained parameters are presented in Fig. 9.

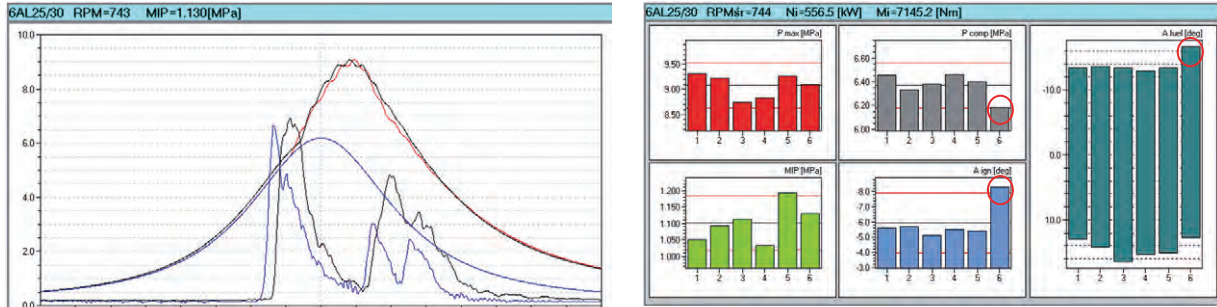

Fig. 9. The tests results from one of the Polish Navy ships equipped with Sulzer engine type 6AL25/30

These results suggest that the compression pressure reached a critical state, and the engine should be taken out of service [3]. Erected however, the question whether actually appeared at the same time two failures, such as:

1. reduced compression pressure of 4.2%,
2. early angle onset of injection and self-ignition of approximately 3.5 ° CA.

It should be noted that the temperature of the suspect cylinder coincides with the average temperature of the remaining cylinders and angles of starts pumping by the fuel injection pump was set at the service stand. This led to believe that the measurement results are falsified by an indicator clogged channel. Since the beginning of the fuel injection of five cylinders are similar, and the pump was tuned, it can be assumed that in the cylinder 6 fuel injection occurs also at the right time, and the pressure course was throttled and shifted by the cylinder pressure duct obstruction. A filter coefficient was selected so as to obtain TDC shift, at which the fuel injection starts were equal with the average angle value. The result of this correction is shown in the bar graph in Fig. 10.

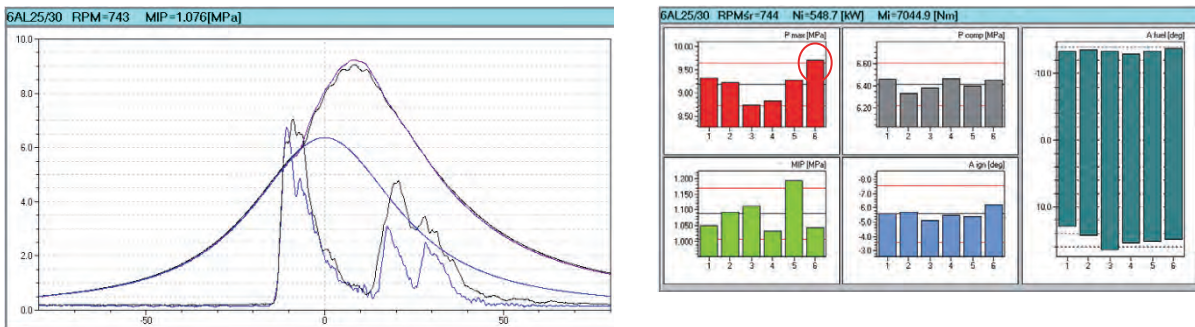

Fig. 10. The result of parameters adjustment with the assumption that throttling occur in the indicating channel cylinder no. 6

As a result of the calculation it was found that the compression pressure has increased and reached a value close to the average of the remaining cylinders. However, there was maximum pressure increase above the permissible limit. This is due to adjustments of the separate cylinder fuel doses to achieve equality between the measured pressures. Error involved by clogged channel resulted in a greater amount of fuel dose regulated by a repair team and, consequently, a maximum

pressure increase above the permissible limit. From a formal point of view, such action was correct. Through this analysis, it was decided that, in spite of the measured low compression pressure value will not have to replace the rings and engine overhaul limited only to clean the indicating channel and reduce the amount of fuel in the cylinder No. 6. Luckily this is an example of how the failure of growth throttling in the indicating channel may lead to misinterpretation of the measurement results and, consequently, to make incorrect maintenance decisions. Unfortunately, none of the indicators currently available does not allow to assess the patency of the cylinder pressure channel, but about the effectiveness of diagnosis in this case decided only the intuition and experience.

Conclusions

A simple IIR filter as a cylinder indicating pressure channel model does not account resonance phenomena. Therefore, the reconstructed waveform is distorted.

These deformations are particularly evident in the area of expansion stroke. Reconstructed course is not suitable for the MIP and heat release calculations.

In the area from the start of compression to the maximum pressure the reconstruction is satisfactory. It allows determine compression pressure, maximum combustion pressure and maximum pressure angle.

The results achieved with the simple model are so promising that it can be expected that the topic is worth further work.

References

- [1] Lus, T., *Tuning method for high-speed Marine diesel engine MB820 type*, Journal of KONES Powertrain and Transport, Vol. 17, No. 2, Warszawa 2010.
- [2] Wimmer, A., Glaser, J., *Indykowanie silnika. Engine indication*, AVL List GmbH Przedstawicielstwo w Polsce, Warszawa 2004.
- [3] Kluj, S., *Diagnostyka urządzeń okrętowych. Diagnosis of marine equipment*, Gdynia: Studium Doskonalenia Kadr S.C. Wyższej Szkoły Morskiej w Gdyni, 1992.
- [4] Cuper, D. Łutowicz, M., *Influence of indicator valve channel untightens and loss of patency on the parameters values image obtained from indicator diagram*, Journal of KONES Powertrain and Transport, Vol. 18, No. 4, Warszawa 2011.
- [5] Łutowicz, M., *Evaluation of the Condition of Cylinder Systems of the Engine Based on a Compression Process Analysis*, Polish Journal of Environmental Studies, Vol. 18, No. 2A, Olsztyn 2009.
- [6] Polanowski, S., *The processing of indicator diagrams with the use of the moving approximating objects*, Combustion Engines, No. 1, 2005.

