

**Tomasz NOWAK, Jerzy JASIEŃKO, Ewa KOTWICA, Sławomir KRZOSEK**

## **STRENGTH ENHANCEMENT OF TIMBER BEAMS USING STEEL PLATES – REVIEW AND EXPERIMENTAL TESTS**

*This paper reviews selected historical and modern methods of strengthening timber structures using steel plates. The results of experimental testing are also presented, emphasizing that the differences in the results obtained were a result of the application of different strengthening methods, test specimens, etc. The need to develop design guidelines related to reinforcement methods is also emphasized. Appropriate reinforcement depends on the application, arrangement and ratio of the reinforcement. The increase in the load-bearing capacity of the beams reinforced by bonded or glued-in plates in comparison to the unreinforced elements was found to be similar to the models reinforced with fibre reinforced polymer (FRP). The increase in stiffness was, however, higher than in the case of the FRP reinforcement. Due to the influence of temperature and humidity on the strength and deformation of the bonding if glued-in or bonded plates are used, additional strengthening of the connection using a mechanical connector is recommended. These connectors also protect against rapid destruction in the case of fire.*

**Keywords:** timber structures, strengthening, repair, steel plates, epoxy

### **Introduction**

Wood is the oldest building material used by man. In early times, timber structures were deeply rooted in human culture to be partially replaced later by stone, then by steel and concrete. Yet wood continues to be widely used as a building material. Numerous examples demonstrate that, in many cases, timber structures are better or safer to use – for example, when fire resistance is important. It is also significant that wood is a natural and renewable material and that the production of timber constructions consumes less energy than in the case of other building materials.

The mechanical properties of different wood species have been tested to indicate which constitute the best construction material [Krzosek et al. 2008].

---

Tomasz NOWAK<sup>✉</sup> ([tomasz.nowak@pwr.edu.pl](mailto:tomasz.nowak@pwr.edu.pl)), Jerzy JASIEŃKO ([jerzy.jasienko@pwr.edu.pl](mailto:jerzy.jasienko@pwr.edu.pl)), Wrocław University of Technology, Wrocław, Poland; Ewa KOTWICA ([ewainga@members.pl](mailto:ewainga@members.pl)), Bud-Logistik, Mierzyn, Poland; Sławomir KRZOSEK ([slawomir\\_krzosek@sggw.pl](mailto:slawomir_krzosek@sggw.pl)) Warsaw University of Life Sciences – SGGW, Warsaw, Poland

Natural wood strength depends not only on anisotropic structure but also on the application, duration and conditions of loading, as well as on the wood type.

In some situations, a strengthening of the wood structure is essential. The need for strengthening is related to the natural properties and structure of the wood and the need to reinforce weaker areas with another material [Nowak et al. 2010].

The repair of timber structures usually involves the use of mechanical connectors, such as nails, screws, etc. The development of engineering materials has significantly influenced building and conservation technologies. Heavy-duty epoxy resins produced at the end of the 1960s were introduced in structural reinforcement interventions.

The reinforcement of timber structures using steel plates (both mechanically connected and bonded) is carried out in the following situations:

1. for the restoration of historical buildings,
2. to improve existing structures, where a planned extension may result in increased loading in relation to the original structure,
3. for the restoration of elements damaged during structural failure,
4. for seismic strengthening in both newly designed and existing timber structures (for improvement or restoration),
5. for newly designed structures, where the strengthening of weak areas is needed (for example, shear reinforcement).

Section 2 of the paper presents selected reinforcement methods involving the installation of steel plates with mechanical connectors, whereas Section 3 deals with strengthening with the use of glued-in or bonded plates.

Since the 1970s, research in Poland has been strongly associated with the restoration of historical buildings. Starting in the 1980s, tests were carried out on glued-in and bonded plates [Jasieńko 2003].

## **Reinforcement with steel plates using mechanical connector techniques**

One of the oldest and simplest ways to reinforce damaged timber beams is to attach steel-plates (or steel profiles) to the sides. Hoath [2006] identified the Middle Ages as a time of historical precedent with respect to the strengthening of timber using steel elements. Plates were bolted or nailed onto the members. This method is commonly used to repair areas of support, for example, when the beam end is rotten. One example showing repair using a mortise and tenon connection between a primary beam and purlins that had been destroyed by insects, is the case of a roof structure built in 15<sup>th</sup> century [Hoath 2006]. Steel plates are connected to the top of the beam and placed on the sides of the purlins and additionally fastened by a mortise and tenon joint.

The 1960s marked the onset of investigations and tests concerning the use of steel and aluminum plates to reinforce timber elements. The goal of the tests

and associated research was to increase the strength and stiffness of wooden elements serving as reinforcement. The application of steel plates or steel profiles was one of the solutions tested, inter alia, by Stern and Kumar [1973], Coleman and Hurst [1974], and Hoyle [1975].

Hoyle [1975] tested elements discovered and patented by S.W. Lindal (steelam). The steelam beam was composed of lumber with toothed steel plates between the lumber pieces (fig. 1). One characteristic of steelam is that there are no visible fasteners on the sides or edges. Pressing is necessary to install the steel plates. The goal of the test was to confirm the method selected for a calculation of the stresses, fastener loads and deflection. Beams used in the test were made of seasoned western hemlock lumber, with maximum moisture content ranging from 17.5% (manufacture conditions) to 8.5% (test conditions). Drying was provided in an uncontrolled way, typical for indoor environments and using a force-dried method. The beams were 4.88 m (16ft) and 6.10 m (20 ft) in length with each one composed of two members and two A36 steel plates measuring 0.106 inches  $\times$  3.0 inches. The steel plates were situated in the top and bottom areas of the beams, along the entire length of the beam (except for the end-areas). The beams were tested cyclically (30 times), then some of them were tested to destruction. Examination after disassembling showed the partial buckling of the steel plates (as a result of spreading lamination) but failure was in the main due to lateral instability. No disconnection of the steelam beams was observed. The application of steel plates resulted in an increase in stiffness of 36% according to calculations, and of 34% according to the test. It can be concluded that the proposed method of calculation was correct and was verified by the test.

Steel plates were used by Coleman and Hurst [1974] as a local reinforcement in the form of:

- steel plates installed between timber members (fig. 2) which were used to resist shear stresses,
- sandwich beams with steel profiles on the top and the bottom of the beam (fig. 3) which were used to resist bending stresses.

The beams were produced from Southern Pine and connected together using nails or – glue-nail connections. The conclusions of the test provided by Coleman, when compared to unreinforced beams (for the moment and shear), were:

- that the ultimate strength of the beams connected using nails was 8-22% higher,
- that the ultimate strength of the glued and nailed beams was 22-37% higher.

In addition, a decrease in deflection (nailed beams – 30-35%, glued and nailed beams – 40%) was obtained through strengthening. Studies have shown the possibility of applying partial reinforcement to reduce both costs and labor input in order to achieve the desired result.

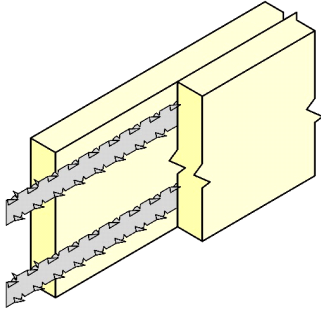

**Fig. 1. Steelam beam [Hoyle 1975]**

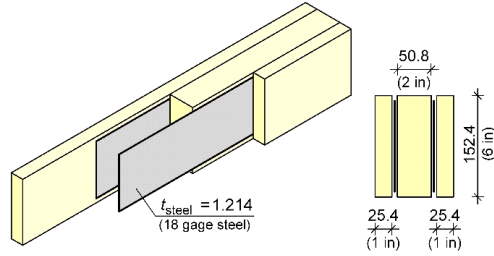

**Fig. 2. Steel location shear test [Coleman and Hurst 1974], (mm)**

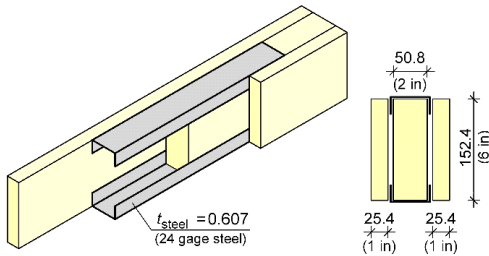
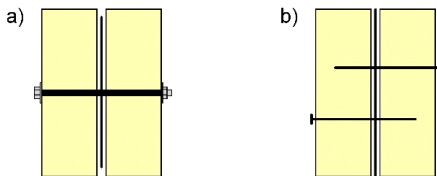

**Fig. 3. Steel location moment test [Coleman and Hurst 1974], (mm)**

Another well known method, used since the end of the 19th century, involves flitch beams with a sandwich configuration: timber-steel-timber (fig. 4a). In this type of beam, the timber takes the load in proportion to the EI values. The sandwich is connected together using mechanical fasteners. The earliest beams were connected using bolts and the height of the

steel plate was lower than the height of the timber members. Nailed connections were subsequently examined [Alam and Ansell 2012].

Tests on flitch beams have continued. Hairstans et al. [2004] presented the results of tests conducted on sandwiches made of timber or Kerto S Laminated Veneer Lumber (LVL) and 3 mm steel plates. Elements were connected using shot fired dowels with a diameter of 3.6 mm and a length of 60 mm. Unlike the traditional flitch beam (fig. 4a), dowels penetrated the second timber member to a depth of ca 12 mm (fig. 4b). Compared to typical flitch beams, where pre-drilling is necessary, the method described by Hairstans et al. [2004] is less time-consuming and therefore cheaper.



**Fig. 4. a – traditional flitch beam, b – shot fired dowel beam (Hairstans et al. 2004)**

The effects of varying nailing density upon the flexural properties of flitch beams were presented by Alam and Ansell [2012]. The results of both the tests and calculations showed a relationship between the density of the nails and flexural stiffness. An increased density of nailing

increases the flexural stiffness but, on the other hand, also causes a reduction in the flexural strength.

Wood is anisotropic which results in different mechanical properties depending on the direction of the grain. For example, the compressive strength perpendicular to the grain is a few times lower than the corresponding strength values parallel to the grain. Tests investigating the differences between wood enhanced by nail plates and unreinforced elements were carried out by Kevarnamäki [1992]. The tests were conducted using three different sorts of nail plates, installed near the end support and on the intermediate support of multi-span beams. 133 enhanced and 42 reference (unreinforced) specimens were tested. It was concluded that the plates placed in the direction of the force offered the best reinforcement capacity. The load carrying capacity of the support area of members 45 mm in width, strengthened in this way, increased by 96%. In the case of plates installed horizontally in the area of support, an increase of 60% in the load capacity was observed. Kevarnamäki also showed that an increase in the load capacity of reinforced elements depends on the width of the members and the type of reinforced material. Reference tests were performed on elements measuring 45 mm in width, elements 70 mm in width, on glulam elements 45 mm in width and on elements made of LVL with a width of 39 mm.

### **Strengthening with glued-in or bonded steel plates**

Epoxy adhesives injected into timber constructions are not only used for structural reinforcement, injections, consolidation or to restore geometric cross-sections [Avent 1986; Cruz and Custódio 2010; Custódio et al. 2011; Bertolini et al. 2013], but also to bond the connections between the reinforcing elements and the elements being reinforced [Arriaga et al. 2013; Cavalli et al. 2014; Yang et al. 2015].

One of the methods used to repair or reinforce timber structures involves the application of steel bars and plates [Leijten 1987; di Alamio et al. 2010; Jasieńko and Nowak 2014], steel cords [Borri and Corradi 2011], FRP bars and tapes [Nowak et al. 2013] or composite materials based on natural fibres [Raftery and Kelly 2015]. The reinforcement can be applied to outer surfaces or inserted inside elements: along the entire length, only in the weakened parts or at the ends [Jasieńko 2001, 2003]. Inserting the reinforcement inside the elements enables this method to be used in the restoration of old historical structures – for example, to repair and reinforce decorative ceilings. Placing the reinforcement inside the beam sections reduces the possibility of delamination of the bonding between the timber and the reinforcement [Metelli et al. 2016], as well as increasing fire resistance compared to an element without external reinforcement.

One of the oldest ways of reinforcing timber structures (using adhesives) involves bonding steel plates, aluminum sheets, as well as rods, placed inside the beam sections. This method was used by Silker [1962] in the early 1960s. Static bending tests were carried out on 15 beams of 2133.6 mm (84 in) in length and cross-sections, which is presented in figure 5. The beams were made of light-weight softwood lamelas: True fir, Eastern Spruce and Lodgepole Pine, glued together using resorcinol adhesive. The aluminum sheets used as reinforcement were 1.6 mm (1/16 in) thick, 127 mm (5 in) wide and 2133.6 mm (84 in) long, and were bonded into the wood with epoxy resins. The beams were tested horizontally (fig. 5 – beams A, B, C, D) and vertically (fig. 5 – beams E, F, G) laminated. Analysis of the composites showed an increase in stiffness in comparison to the beams without any reinforcement, as well as an increased loading capacity at the proportional limit. A reduction in the stiffness and strength variation among beams of the same size was also observed. The strength of the beam reinforced for tension and compression was determined by the shear strength of its section. Horizontally laminated beams with reinforcement were found to be in line with the theoretical stiffness. Vertically laminated beams did not demonstrate such a good correlation with the theoretical assumptions. The difficulty also involves inter alia finding ways of connecting two materials which have very different structures and mechanical properties.

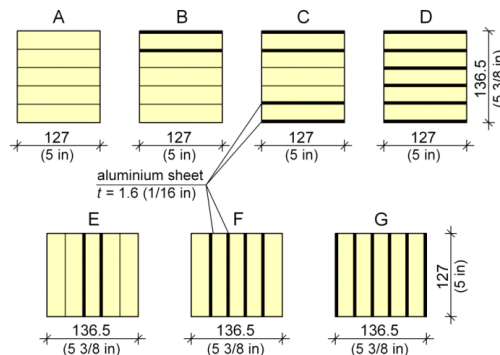

**Fig. 5. Sections of beams reinforced with aluminum [Silker 1962], (mm)**

The idea of reinforcing glued laminated timber beams appeared in 1960s and 1970s. Research was carried out by Borgin et al. [1968], who placed steel plates inside the beam section using epoxy adhesives. The reinforcement was placed only in the compressed part or symmetrically, on the top and the bottom (fig. 6). Beams reinforced only in the compressed zone were abruptly destroyed in the tension zone. Borgin concluded that it is necessary to use laminations with the highest mechanical properties in the bottom, outer zone of the laminated beam, as reinforcement. The research also showed a significant increase in shear strength in one-sided reinforced beams compared to beams with symmetrical

reinforcement. This reinforcing method, however, increases the strength and stiffness of the elements. Borgin recommended the symmetrical reinforcement of beams using steel with a low module of elasticity and a large elastic range.

Steel plates can be also used to pre-stress the wood sections. As the pre-stressing of beams using steel does not improve the stiffness, Peterson [1965] devised a method of strengthening glued laminated beams with a pre-stressed strip of high-strength steel applied to the bottom face of the beam (fig. 7). This way of installing the reinforcement was supposed to increase the stiffness of the beam. According to Ganowicz and Latusek [1978], the lack of visible influence of the strips' pre-stressing on beam stiffness was due to the fact that the stressing force was simply transferred to the end face of the beam, instead of to the whole length (as is the case with the tape). Tests were carried out on 6 reference (without reinforcement) and 6 prestressed beams. Figure 7 presents the section and the test stand scheme of the beams analyzed.

The pre-stressed beams compared to the reference beams showed an increase in stiffness of approximately 26% and an increase in strength of ca 76%. It was also noted that the coefficient of variation decreased in the pre-stressed beams.

The need to strengthen glue joints with mechanical connections to guarantee the transmission of the load from the steel plates to the timber beam in case of loss of adhesion (fire or delamination) was pointed out by Metelli et al. [2013]. The paper presents an example of the application of bonded steel plates to reinforce ceiling beams (made of larch) in a floor dating back to the 15th century in Palazzo Calini (Brescia, Italy).

Rheological deformation is an important issue in the process of calculating the deflection of beams reinforced with glued-in steel plates. Neglecting rheological influence can lead to an underestimation of the final deflection, and rheological deformations can have values similar to elastic deformations [Misztal and Socha 1996].

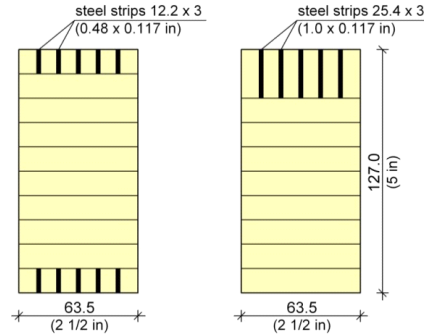

**Fig. 6. Sections of beams strengthened with steel tapes [Borgin et al. 1968], (mm)**

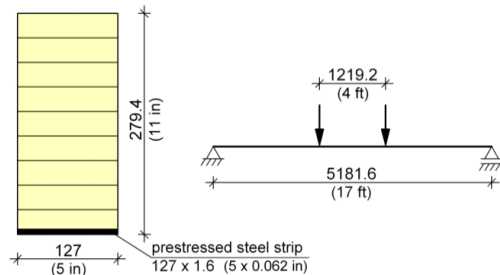

**Fig. 7. Section and test stand scheme of the analyzed beam [Peterson 1965], (mm)**

The influence of temperature, humidity and dynamic loading (10,000,000 load cycles) on the connection of perforated steel plates bonded to timber elements was tested by Bathon et al. [2014]. The conclusion of the test was that this innovative coupling system can also be used in timber structures under fatigue loading conditions.

It is worth noting that the methods mentioned above are also used to reinforce concrete structures. The issue of bonding external steel plates with epoxy compositions to repair and strengthen concrete beams was researched for example by Swamy et al. [1987].

### **Research concerning bending of timber beams strengthened with glued-in or bonded plates – materials and method**

Tests were carried out on timber beams measuring  $100 \times 200 \times 4000$  mm made of pine wood (*Pinus sylvestris* L.). The beams for research were made of new wood (NW) and old wood (OW). The old wood was estimated to be 80-100 years old.

The models were strengthened using steel plates with a thickness of 2, 3, and 4 mm. Before their application the plates were sandblasted and carefully degreased with acetone. The epoxy composition used in the test contained the following:

- Epidian 5 resin – 100 parts by weight,
- quartz flour – 230 parts by weight,
- dibutyl phthalate – 10 parts by weight,
- Z-1 amine hardener – 11 parts by weight,
- Aerosil (optional) – 2 parts by weight.

Aerosil is a substance which stabilises the adhesive composition (thixotropic) and is only used to apply reinforcement to the outer surfaces of the beams.

The modulus of elasticity values of the used materials were determined in a bending test for wood, in a tension test for steel and a compression test for epoxy adhesive:

- new wood (NW) – 10 500 MPa (Std. dev. 1510),
- old wood (OW) – 9 500 MPa (Std. dev. 990),
- steel plates – 210 000 MPa (Std. dev. 6700),
- epoxy adhesive – 9800 MPa (Std. dev. 470).

The 3900 mm span beams were tested in a four point bending test (fig. 8). Fork supports (laterally positioned) were used to prevent bending stability loss (lateral buckling). For the strength test, a 600 kN capacity hydraulic jack was used to apply loading pressure. The rate of the monotonic pressure applied was 3 kN/min.



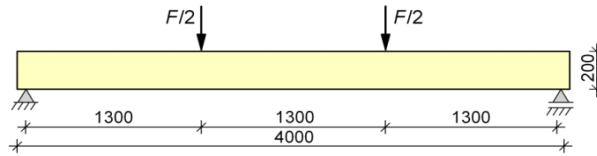
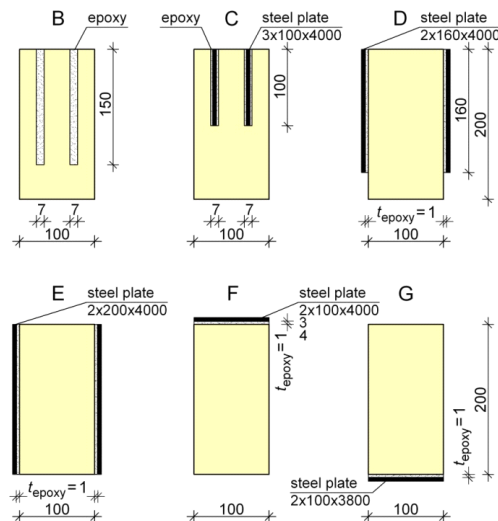

**Fig. 8. Loading configuration and dimensions of tested beams, (mm)**

The research was carried out on 23 models made of new wood (NW) and 23 models made of old wood (OW). Each group of models comprised 7 different types. –The beams were as follows:

- series A – reference (unreinforced) beams,
- series B – beams with epoxy adhesive introduced into the cross section,
- series C – beams with 2 steel plates inserted into the cross section;
- series D – beams with 2 steel plates with a height less than the full beam height, bonded to both side faces,
- series E – beams with 2 steel plates covering the full beam height, bonded to both side faces,
- series F – beams with 1 steel plate of differing thicknesses ( $t_{\text{plate}} = 2; 3; 4$  mm), bonded to the upper face,
- series G – beams with 1 steel plate bonded to the bottom face.

Figure 9 shows the cross sections of the tested specimens. Models B, C and F are useful in restoration work when it is possible to apply the reinforcement from the top. This method allowed the reinforcement of the construction without destroying the historical value and decorations (painted decorations, wood carvings, etc.) on the bottom and side faces.



**Fig. 9. Cross sections of tested beams, (mm)**

The proposed method of gluing-in plates from the top into the section (series C) reduces the possibility of delamination of the bond between the steel plates and the timber, and increases the element's fire resistance.

## Results and discussion

Tables 1 and 2 present the average values of the ultimate force (the  $F_u$  mean) for each individual series, as well as the proportional increase in strength ( $\Delta F$ ) in comparison to the reference beams from set A, based on equation (1). The beams from series F were named F-2, F-3 and F-4 according to the thickness of the plate used ( $t_{\text{plate}} = 2; 3; 4$  mm). Tables 1 and 2 also show the mean increase in stiffness ( $\Delta EI$ ) of the reinforced beams in comparison with the unreinforced reference beams for force ranging from 6 kN to 18 kN.

$$\Delta F_u = \frac{F_{u,mean,B-F} - F_{u,mean,A}}{F_{u,mean,A}} \cdot 100\% \quad (1)$$

**Table 1. Ultimate force, increase in load-bearing capacity and increase in stiffness of tested beams made of new wood (NW)**

Beam series	Number of specimens	Ultimate force $F_u$ (kN)			Increase in load-bearing capacity $\Delta F_u$ (%)	Increase in stiffness $\Delta EI$ (%)
		min value	max value	mean value		
A	3	33.8	35.0	35.0	–	–
B	3	39.6	50.7	44.1	26.0	-17
C	3	57.6	60.4	59.0	68.6	47
D	3	52.4	54.4	53.5	52.8	57
E	3	53.4	54.6	53.9	54.0	54
F-2	2	41.6	45.4	43.5	24.3	44
F-3	2	34.0	36.0	34.8	0.0	31
F-4	2	41.2	42.2	41.7	19.1	21
G	2	35.7	38.9	37.3	6.6	20

Figures 10 and 11 show the load-deflection plot for the beams from all the series. For a comparison, the area designated by the load-deflections plot of the reference (unreinforced) beams (series A) made of new wood (NW) and old wood (OW) are shown. The vertical lines on the graphs show the limit deflection for ceilings with the limit value of  $L/250$ . Additionally, the graphs show deflection in the value of  $L/167$ , which increased 50% for the old renovated buildings, in accordance with the Polish annex to Eurocode 5 [PN-EN 1995-1-1: 2010].

**Table 2. Ultimate force, increase in load-bearing capacity and increase in stiffness of tested beams made of old wood (OW)**

Beam series	Number of specimens	Ultimate force $F_u$ (kN)			Increase in load-bearing capacity $\Delta F_u$ (%)	Increase in stiffness $\Delta EI$ (%)
		min value	max value	mean value		
A	3	24.9	27.2	26.0	-	-
B	3	34.5	36.9	35.4	36.2	-14
C	3	51.0	53.1	52.1	100.5	51
D	3	48.5	50.7	49.7	91.2	77
E	3	48.7	50.6	49.7	91.3	62
F-2	2	34.2	36.1	35.2	35.2	68
F-3	2	35.0	36.4	35.7	37.3	55
F-4	2	40.4	42.1	41.3	58.7	31
G	2	36.1	37.3	36.7	41.2	10

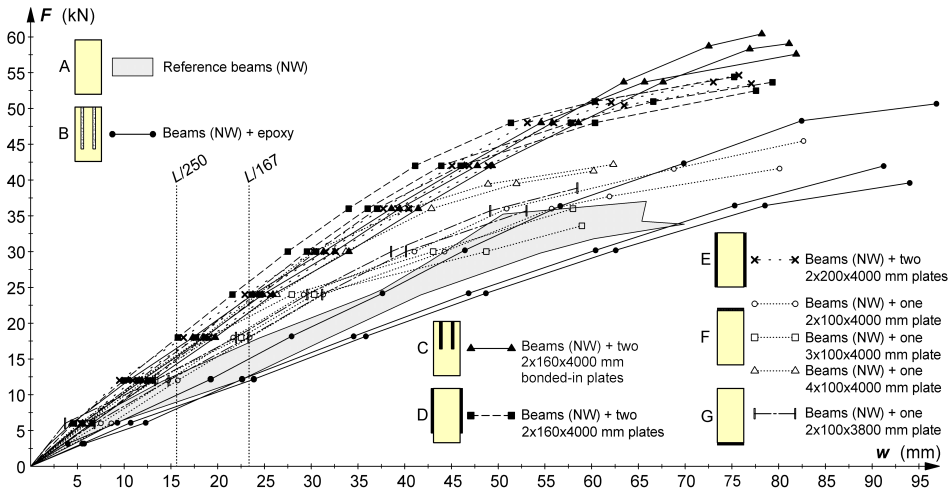
**Fig. 10. Load-deflection plot for specimens from new wood (NW)**

The tests results were more qualitative than quantitative in nature because of the small number of samples in each series (especially series F and G - 2 beams each).

The increase in the strength of the beams tested (up to 100% – tabs. 1 and 2) when compared to the reference beams – both made of new wood (NW) and old wood (OW) – was comparable to the models reinforced with FRP [Borri et al. 2005; Nowak et al. 2013]. The increase in stiffness was higher than in the beams reinforced with FRP. In the tests described here, the increase in strength in the beams reinforced with FRP was 10-77% (tabs. 1 and 2). However, there are other aspects other than the increase in stiffness and strength that determine the advantage of using FRP over steel, such as the weight and corrosion resistance, which is important for the quality of steel-wood bonding [Ishiyama et al. 2014]. Placing steel plates inside the wood section also provides corrosion resistance.

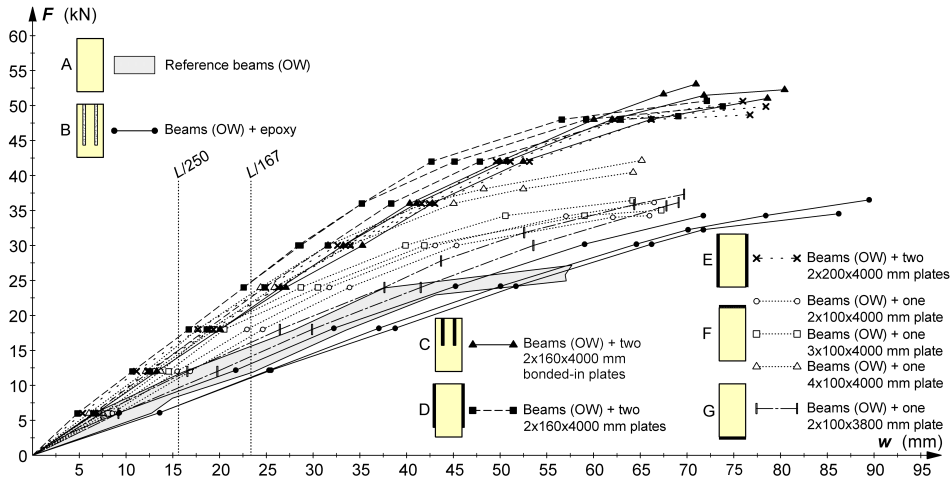

Fig. 11. Load-deflection plot for specimens from old wood (OW)

The technical simplicity and the test results suggest that the method of strengthening beams used with series C is likely to become common in the restoration of historical buildings. Failure of series C beams proceeded as follows: the first break occurred in the tension zone, followed by successive fractures in the compressed zone. No separation of the steel plates occurred. Due to the steel reinforcement, no rapid destruction was observed.

## Conclusions

The following general conclusions regarding timber member reinforcement using steel plates were formulated based on analysis of the available literature and on the basis of research and experimental testing:

1. Appropriate strengthening depends on the reinforcement ratio and the arrangement of the reinforcement (steel, FRP, etc.) [Raftery and Whelan 2014]. As Kliger et al. [2007] stated, reinforcement can be used to control the strength, stiffness and failure modes.
2. Glue joints assure the continuity of the cross section and a uniform interaction between the original elements and the reinforcing ones, which is practically impossible to achieve using mechanical connectors only.
3. The application of steel plates connected mechanically is less effective than those glued-in. Lower efficiency is caused by, inter alia, the weakening of a section by drilling holes for bolts. It should be mentioned here that using glued-in plates or bolts - the glue penetration in the eventual cracks can help maintain the structure of the beam but can also change the local stiffness of the member. Coleman and Hurst [1974] indicated that the stiffness of the nailed steel-reinforced beams was ca 50% higher than when using glued and nailed steel-reinforced beams,

which caused a doubling of the stiffness. Nonetheless, mechanically connected plates can be easier to install in building site conditions and regardless of weather conditions.

4. The increase in the load-bearing capacity of the beams reinforced with bonded or glued-in plates in comparison to the unreinforced elements was comparable to the models reinforced with FRP. The stiffness increase was, however, higher than in the case of FRP reinforcement [Alam et al. 2009].
5. FRP reinforcement is more expensive than steel and the load-bearing capacity utilization of this reinforcement does not usually exceed 20% [Jankowski et al. 2010], whereas with steel plates it is up to 80% [Jasieńko 2003]. It is also worth clarifying that steel plates need to undergo the difficult process of sandblasting in order to achieve the necessary adhesion to wood.
6. Due to the influence of temperature and humidity on the strength and deformation of the bonding if glued-in or bonded plates are used, additional strengthening of the connection by mechanical connector is recommended. These connectors also protect against rapid destruction in the case of fire.
7. It is extremely important to take into account the properties of the wood and materials used for reinforcement, inter alia, differences in the linear thermal expansion in wood and steel. These differences may cause checks in the timber members. External steel plates are not recommended for use in the area of skylights or other places, where plates can be exposed to strong sunlight.
8. Research on the behaviour of timber elements must take into account not only technical issues, but also the historical and artistic value of the object. Decisions to replace old structures with new ones are made too often and too easily. Such interventions are against the principles of historical building conservation. Changes in the loading of the structure, including the foundations, must be taken into consideration in all such cases prior to deciding to replace old elements. The impact resulting from the replacement of historical elements with new ones can cause cracks in the walls, an uneven settlement of the foundations, etc.
9. In conclusion, it is worth noting that work on reinforcement calculations is on-going, with the potential goal of adding essential design recommendations to the revised version of Standard Eurocode 5, as clear rules on reinforcement design are crucial.

## References

- Alam P., Ansell M.** [2012]: The effects of varying nailing density upon the flexural properties of flitch beams. *Journal of Civil Engineering Research* 2 [1]: 7-13
- Alam P., Ansell M.P., Smedley D.** [2009]: Mechanical repair of timber beams fractured in flexure using bonded-in reinforcements. *Composites Part B: Engineering* 40 [2]: 95-106
- Arriaga F., Iñiguez-Gonzalez G., Esteban M., Fernandez-Cabo J.** [2013]: Simplified model for strength assessment of timber beams joined by bonded plates. *Journal of Materials in Civil Engineering* 25 [8]: 980-990
- Avent R.R.** [1986]: Design criteria for epoxy repair of timber structures. *Journal of Structural Engineering* 112 [2]: 222-240
- Bathon L., Bletz-Mühldorfer O., Schmidt J., Diehl F.** [2014]: Fatigue design of adhesive connections using perforated steel plates. *Proceedings of the World Conference on Timber Engineering 2014, WCTE 2014, Quebec City, 10-14 August 2014, paper no. 163*
- Bertolini M.S., Macedo L.B., Almeida D.H., Icimoto F.H., Lahr F.A.R.** [2013]: Restoration of structural timber elements using epoxy resin: analysis of mechanical properties. *Advanced Materials Research* 778: 582-587
- Borgin K.B., Loedolff G.F., Saunders G.R.** [1968]: Laminated wood beams reinforced with steel strips. *Journal of Structural Division* 94 [7]: 1681-1705
- Borri A., Corradi M.** [2011]: Strengthening of timber beams with high strength steel cords. *Composites Part B: Engineering* 42 [6]: 1480-1491
- Borri A., Corradi M., Grazini A.** [2005]: A method for flexural reinforcement of old wooden beams with CFRP materials. *Composites Part B: Engineering* 36 [2]: 143-153
- Cavalli A., Malavolti M., Morosini A., Salvini A., Togni M.** [2014]: Mechanical performance of full scale steel-timber epoxy joints after exposure to extreme environmental conditions. *International Journal of Adhesion and Adhesives* 54: 86-92
- Coleman G.E., Hust T.H.** [1974]: Timber structures reinforced with light gage steel. *Forest Products Journal* 24 [7]: 45-53
- Cruz H., Custódio J.** [2010]: Adhesives for on-site rehabilitation of timber structures. *Journal of Adhesion Science and Technology* 24 [8-10]: 1473-1499
- Custódio J., Broughton J., Cruz H.** [2011]: Rehabilitation of timber structures - Preparation and environmental service condition effects on the bulk performance of epoxy adhesives. *Construction and Building Materials* 25 [8]: 3570-3582
- di Alaimo G., Failla A., Accurso F., Tesè F.** [2010]: The durability of composite wood-steel systems. *Proceedings of the 18th CIB World Building Congress, May 2010, Salford, United Kingdom: 198-209*
- Ganowicz R., Latusek D.** [1978]: Wstępne sprężanie konstrukcji drewnianych (The pre-stressing of timber structures). *Proceedings of the Symposium: Badania nad zastosowaniem drewna i materiałów drewnopochodnych we współczesnych konstrukcjach budowlanych (Research on the use of wood and wood products in modern building structures), June 1978, Szczecin: 281-291 [in Polish]*
- Hairstans R., Kermani A., Lawson A.** [2004]: Shot fired dowel & adhesively bonded flitch beams. *Proceedings of the COST E29 Symposium, 27-29 October 2004, Florence, Italy: 21-29*
- Hoath J.** [2006]: Repairing historic roof timbers. *Historic Churches* 13: 25-27
- Hoyle R.J.** [1975]: Steel – reinforced wood beam design. *Forest Products Journal* 25 [4]: 17-23
- Ishiyama H., Nakajima M., Mori T., Noda Y., Tsuchimoto T.** [2014]: Exposure test of surface-treated steel plates on preservative-treated woods. *Proceedings of the World*

- Conference on Timber Engineering 2014, WCTE 2014, Quebec City, 10-14 August 2014, paper no. 526
- Jankowski L.J., Jasięko J., Nowak T.P.** [2010]: Experimental assessment of CFRP reinforced wooden beams by 4-point bending tests and photoelastic coating technique. *Materials and Structures* 43 [1-2]: 141-150
- Jasięko J.** [2001]: Glue joints used for reinforcing the damaged ends of wooden beams. *Structural Engineering International* 11 [4]: 246-250
- Jasięko J.** [2003]: Połączenia klejowe i inżynierskie w naprawie, konserwacji i wzmacnianiu zabytkowych konstrukcji drewnianych (Glued and engineering joints in repair, conservation and reinforcement of historical timber structures). Dolnośląskie Wydawnictwo Edukacyjne, Wrocław [in Polish]
- Jasięko J., Nowak T.P.** [2014]: Solid timber beams strengthened with steel plates - experimental studies. *Construction and Building Materials* 63: 81-88
- Kevarinmäki A.** [1992]: Strength of Finnish softwoods in compression perpendicular to grain and reinforcement of support areas with nail plates. *Rakenteiden Mekaniikka* 25 [1]: 36-52
- Kliger R., Al-Emrani M., Johansson M., Crocetti R.** [2007]: Strengthening glulam beams with steel and composite plates. *Proceedings of the Asia-Pacific conference on FRP in structures*, Hong Kong, China, 12-14 December 2007: 291-296
- Krzosek S., Grześkiewicz M., Bacher M.** [2008]: Mechanical properties of Polish-grown *Pinus silvestris* L. structural sawn timber. *Proceedings of the COST E53 Conference 29-30 October 2008*, Delft, The Netherlands: 253-260
- Leijten A.J.M.** [1987]: Balkkop restauratie met ingelijmde staalplaten (Beam head restoration with glued steel plates). *Rapport 25-87-8/5-LV-6*, TU Delft, Netherlands [in Dutch]
- Metelli G., Giuriani E., Marchina E.** [2013]: The repair of timber beams with controlled-debonding steel plates. *Advanced Materials Research* 778: 587-595
- Metelli G., Preti M., Giuriani E.** [2016]: On the delamination phenomenon in the repair of timber beams with steel plates. *Construction and Building Materials* 102: 1018-1028
- Misztal S., Socha T.** [1996]: Odkształcenia pełzania zginanych elementów drewnianych wzmacnionych przyklejonymi wkładkami metalowymi (Creep deformations of bent timber members strengthened with bonded steel plates). *Proceedings of the International Scientific Symposium: Drewno i materiały drewnopochodne w konstrukcjach budowlanych (Wood and wood products in timber structures)*, Szczecin-Międzyzdroje, 5-6 September: 219-226 [in Polish]
- Nowak T.P., Jankowski L.J., Jasięko J.** [2010] Application of photoelastic coating technique in tests of solid wooden beams reinforced with CFRP strips. *Archives of Civil and Mechanical Engineering* 10 [2]: 53-66
- Nowak T.P., Jasięko J., Czepiżak D.** [2013]: Experimental tests and numerical analysis of historic bent timber elements reinforced with CFRP strips. *Construction and Building Materials* 40: 197-206
- Peterson J.** [1965]: Wood beams pre-stressed with bonded tension elements. *Journal of Structural Division* 91 [1]: 103-119
- Raftery G., Kelly F.** [2015]: Basalt FRP rods for reinforcement and repair of timber. *Composites Part B: Engineering* 70: 9-19
- Raftery G., Whelan C.** [2014]: Low-grade glued laminated timber beams reinforced using improved arrangements of bonded-in GFRP rods. *Construction and Building Materials* 52: 209-220
- Silker A.** [1962]: Reinforced wood laminated beams. *Forest Products Journal* 12 [1]: 91-96

- Stern E.G., Kumar V.K.** [1973]: Flitch beams. *Forest Products Journal* 23 [5]: 40-47
- Swamy R.N., Jones R., Bloxham J.W.** [1987]: Structural behaviour of reinforced concrete beams strengthened by epoxy bonded steel plates. *The Structural Engineer* 65 [2]: 59-68
- Yang X., Gong M., Chui Y.H.** [2015]: End reinforcement of wood member using short-cut carbon fibers. *European Journal of Wood and Wood Products* 73: 159-165

#### **List of standards**

- PN-EN 1995-1-1:2010.** Eurocode 5: Design of timber structures – Part 1-1: General – common rules and rules for buildings [in Polish]