

WEATHER ROUTING SYSTEM ARCHITECTURE USING ONBOARD DATA COLLECTION AND ROUTE OPTIMISATION

Joanna Szłapczyńska¹

Roberto Vettor²

Rafał Szłapczyński³

Mirosław Łącki¹

Marcin Życzkowski³

Miguel A. Hinostroza²

Fernando P. Santos²

Wojciech Tycholiz⁴

C. Guedes Soares²

¹ Gdynia Maritime University, Faculty of Navigation, Poland

² Centre for Marine Technology and Ocean Engineering (CENTEC), Instituto Superior Técnico, Universidade de Lisboa, Portugal

³ Gdańsk University of Technology, Faculty of Mechanical Engineering and Ship Technology, Poland

⁴ NavSim sp. z .o.o, Poland

* Corresponding author: j.szlapczynska@wn.umg.edu.pl (J. Szłapczyńska)

ABSTRACT

This paper describes the architecture of a weather routing system consisting of two key elements: onboard monitoring and route optimiser sub-systems. The former is responsible for collecting various onboard measurements, such as current ship position or ship motion variables. These data, when gathered and processed, are then used for fine-tuning a ship model. The model, together with weather forecasts, is utilised by a multi-objective route optimiser to estimate forecasted ship responses during the voyage. The route optimiser has been developed in a client-server architecture to reallocate all necessary high-tech resources to the server side and keep the client software as simple and light as possible. The system also includes a module responsible for optimising transmission costs, to reduce onboard transmission during the voyage. The entire solution has been deployed onboard the demonstrator ship 'Monte da Guia' and tested during its operations at sea.

Keywords: system architecture, weather routing, onboard data monitoring, route optimisation, data transmission optimisation

INTRODUCTION

The optimisation of planned shipping routes based on forecast ship responses to weather conditions is the aim of ship Weather Routing (WR). However, the goal functions may vary during the optimisation procedure. Historically, the first approach was to minimise voyage time by the isochrone method [1], where routes were determined manually. Computer implementations of this method were then developed [2]. However, the isochrone method had a single objective and struggled to deal with dynamic constraints. Other approaches

to WR include dynamic programming [3–5] such as waves, tidal currents, and wind are important factors for safe and economic ship navigation. In previous papers of Xia et al. (2006a, 2006b). Graph algorithms have also been applied, as described in [6] and [7] which is modified using a directional resolution of less than 27 degrees. The shortest path is recovered using a modified Dijkstra's algorithm. Safety restrictions for avoiding surfripping and parametric rolling according to the guidelines of the International Maritime Organization (IMO) (for motor-driven vessels) and in [8] and [9] (for sailing vessels). Lately, multi-objective approaches to WR have been tried, either

by the aggregation of the objectives to a single criterion (as in [10]) or by maintaining the most promising solutions (as in [11]). Dynamic programming and evolutionary algorithms have become more popular, allowing the return of a set of favourable solutions in the form of Pareto-optimal sets [12]–[14] reliable and economical ship operation. The more reliable the weather forecasts and the performance simulation of ships in a seaway become, the better they serve to identify the best possible route in terms of criteria like estimated time of arrival (ETA).

A major problem for contemporary WR is the stochastic behaviour of oceanic and atmospheric processes, making weather forecasts uncertain. Considering all of the above, both uncertainty handling and multi-objective optimisation were the priorities of the research started in [15], where the system’s outline was provided. Unlike the outline, this paper is focused on the architecture of the already designed and deployed system. It is quite common to find research papers describing the architecture of various systems supporting ship navigation, e.g. [16] and [17]. Unfortunately, the other state-of-the-art WR solutions are often parts of commercial systems and so even a rough description of their system architecture is not available in the public domain. This paper aims to fill this gap by providing the necessary system design and architecture description of a weather routing system created during the course of the ROUTING (MarTERA-1) project.

The rest of the paper is organised as follows. The system’s overview is given in the next section, followed by descriptions of the system’s main components. i.e. the onboard monitoring sub-system and client-server route optimiser. This is then followed by a description of the module responsible for optimisation of the onboard data transmission. Finally, the system’s deployment process is presented and the research conclusions are stated.

SYSTEM OVERVIEW

When designing the system, the authors assumed that the optimisation of weather route planning should be based on ship modelling, fine-tuned by data gathered onboard ship. Another important requirement was to design a distributed (onboard and shore) system, offering the best possible efficiency but also

prone to technical disturbances. To fulfil these requirements, a system was built, as presented in Fig. 1.

The system comprised two key elements: a monitoring sub-system and route optimisation sub-system. The former is responsible for collecting various onboard measurements, such as current ship position and ship motion variables. These data, when gathered and processed were then used to fine-tune the ship model. Since the demonstration ship ‘Monte da Guia’ features equipment for the reduction of fuel consumption, the ship meta-model was split into ‘shaft-on’ and ‘shaft-off’ sub-modules. The updated ship model was then utilised in route optimisation, to estimate forecast ship responses during the voyage. The optimisation system was designed in client-server architecture to separate user data collection and the results visualisation layer (WR Client) from the core optimisation procedures (WR Server), which are time and resource consuming. This two-tier system architecture allowed the processing of an unlimited number of route optimisation requests sent by different users (various instances of WR Client). The serialisation of upcoming parallel user requests was carried out according to the First In – First Out (FIFO) processing scheme on the server-side.

WR Server is additionally supported by a weather forecast collector server, providing constant access to up-to-date weather (wind, wave and sea current) forecasts for the research area (the Azores and Portuguese coast). The server gathers selected forecasts from various sources (NOAA and Copernicus), unifies file formats (converting to GRIB2, when necessary), trims the data to the area of interest and packs all the files into a single ZIP archive, available for upload via an HTTPS static link.

The following subsections elaborate on the architecture of the key sub-systems, namely the onboard monitoring and client-server (WR Client and WR Server) route optimiser.

ONBOARD MONITORING SUB-SYSTEM

The demonstration container ship ‘Monte da Guia’ was equipped with a system to monitor and record several parameters of interest. The system was installed in 2021 and has been recording data since then. Fig. 2a shows the GPS plots for an 11-day trip. The route starts in the port of Leixões in north

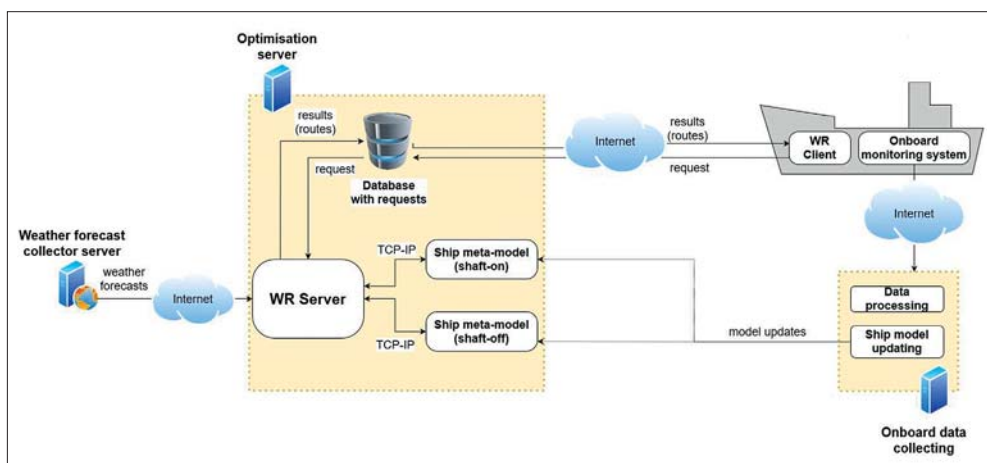

Fig. 1. ROUTING system overview

Portugal, crosses the Atlantic Ocean (to supply several islands in the Portuguese Azores archipelago (lags between islands may vary)), and heads back towards continental Portugal, stopping in Lisbon and then returning to Leixões.

The onboard layout of the sensors and equipment were as shown in Fig. 2b. A GPS antenna and a weather station were placed on the highest deck over the bridge (Fig. 2c). An Onboard Desktop Computer (ODC), an Inertial Measurement Unit (IMU) (Fig. 2c), data receivers for GPS and weather stations, and a Long Range (LoRa) with GSM gateway were installed on the bridge. The ultrasonic flowmeter and LoRa Terminal were installed in the machine room and the strain gauges were distributed along the ship's hull structure, in the proximity of the main deck. The dataset was recorded and integrated on the ODC and automatically sent ashore to a server, through a 4G communication network (when available). This system was an upgraded version of the one installed in [18].

IMU OCTANS was installed, and this is a fibre-optic survey-grade IMO-certified gyrocompass and Motion Reference Unit for marine applications (Fig. 2c). It provides true-heading, roll, pitch, yaw, heave, surge, sway, rates of turn and accelerations with a resolution of 0.01 degrees and can find True North. Its position relative to the ship's centre of gravity was recorded for online corrections.

The weather station (Fig. 2c) was a Vantage Pro2™ (VP2) wireless weather station from Davis Instruments© which consisted of the following: a rain collector; temperature, humidity, and barometric sensors; and an anemometer to read the relative wind speed and direction. Along with the ship speed, estimated from the GPS data and the heading measurements from the IMU, the data were used to estimate the absolute wind speed and direction relative to true north, respectively. A Weather Envoy (WE) data receiver was placed on the vessel's bridge, which sent the outside weather data to the ODC [19, 20] via a data logger. The VP2 was configured to record the averaged and not-averaged weather data in 1-minute intervals and to automatically download it to a text file on the ODC every 5 minutes [21].

A KATflow 100 ultrasonic flowmeter was based on two clamp-on sensors (Fig. 2d), with a datalogger for the measurement of liquids in fully enclosed pipes [22]. The sensors were installed on the outer surface of the fuel intake pipe of the propulsion engine in the machine room, to measure the fuel consumption in real-time. The data was sent from the datalogger to the ODC through a wireless LoRa terminal.

The F8L10T LoRa terminal (from Four-Faith©) connected to the flowmeter was a wireless data transmission device based on LoRa Spread Spectrum Communication Technology [23]. The terminal sent the data at intervals of 1 second, to the F8926-L LoRa and GSM gateway [24], connected via ethernet to the onboard desktop computer, which saved the data as .txt files.

Two SM-5A surface-mounted Vibrating Wire Strain Gauges (VWSG) (from SMARTEC©) were welded on structural reinforcements on the main deck close to midship (port and starboard) and two others near one third and three-thirds of the lengths of the ship (portside only), to monitor the global hull stresses and deformations (Fig. 2b). The VWSG were connected

to a four channel RT-VLOG datalogger from ROCTEST© by long cables which, and this, in turn, communicated with the ODC through a 50 m USB – UTP extender. The changes in the resonant frequency of the vibrating wires were proportional to the strain changes on the surface under study [25]. The datalogger worked in conjunction with the Logger Manager software [26 and 27].

The system provided a thorough quantitative insight into the ship's typical operating conditions and performance. The dataset was initially processed to validate and tune the ship model used, via route optimisation software. At a second stage, the measured data allowed the development of a grey-box model which was continuously updated in real-time, accounting for factors such as fouling and equipment ageing, to reduce model uncertainties and improve the overall quality of the predictions.



(a)

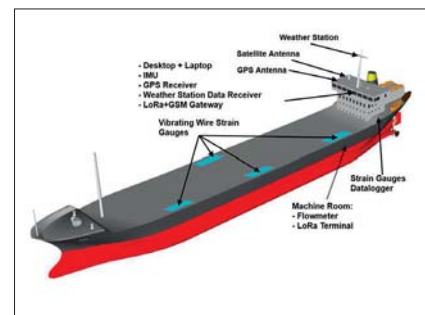

(b)



(c)



(d)

Fig. 2. (a) Example of 11-day itinerary of the ship, (b) Distribution of sensors onboard ship, (c) Monitoring system on the bridge, (d) Flowmeter clamp-on sensors in the machinery room

CLIENT-SERVER ROUTE OPTIMISER

The route optimiser system comprised two elements: Weather Routing (WR) Client and Server. WR Client is an end-user software, providing a Graphical User Interface (GUI) for the route optimiser (data input and resulting route presentation), whereas WR Server is a server-side application, providing business intelligence of weather routing (performing tasks of route optimisation, including multi-objective optimisation with constraints, loading weather forecast data, etc.). The data exchanged between WR Client and WR Server was stored in a database (DB) on the server side. The special plain-text data exchange interface allows for smoothly sharing route requests and route results between the client and the server. Additional weather forecasts required for server-side computations were obtained from the weather forecast collector server (<https://martera.navsim.pl/rawdata>).

A weather routing client-server data exchange protocol was implemented in both WR Client and WR Server software for efficient two-way communication. The communication between client and server was as follows (Fig. 3):

1. WR Client sends data as a new request to the server database (DB);
2. WR Server fetches data from the DB and updates the status of the request in DB;
3. WR Server fetches weather forecast data from local files and starts the computations;
4. Client checks the status of the request. The current request can be cancelled or the results can be obtained after waiting (by checking later on) for the computation's progress;
5. WR Server (when handling the request has finished) saves the results of the computations in DB;
6. WR Client (when the status of the current request is '100%') gets the results of the computations from DB;
7. Script periodically gets weather forecast data from the service (every 6 hours);
8. Script unpacks the archive and saves weather forecast grib2 files in the local repository.

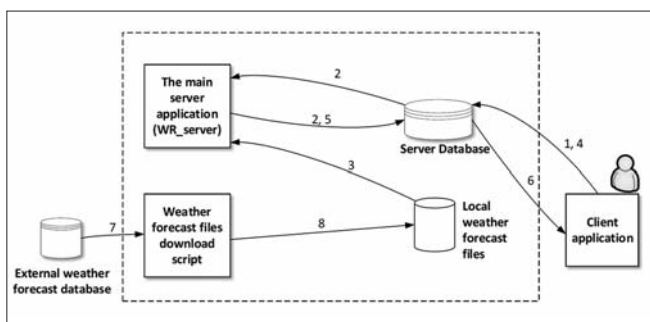

Fig. 3. WR client-server data exchange protocol

The WR Client connects to the WR Server multiple times per one route optimisation request: the first time to send a new request and then to refresh its status (progress). Such an asynchronous approach is necessary due to the time-consuming calculations, the uncertainty of the transmission quality and possible high transmission costs (in the case of a satellite onboard data transmission).

In the next subsections, a more detailed description of WR Client and WR Server applications are presented.

CLIENT-SIDE APPLICATION (WR CLIENT)

In general, WR Client is an ENC-class software, installed on a local PC located on the ship's bridge, and it is able to present to the user (the shipmaster or navigator) candidate ship routes, sea charts, and weather forecast parameters, etc. in a graphical way. This is why NaviWeather software (by NavSim) is utilised as the ENC-class container. A separate plug-in to NaviWeather was implemented (in C++, utilising the NaviAPI interface) to provide the functionality expected by the end ROUTING user. Fig. 4 shows the basic elements of the WR Client application (in a Use Case diagram).

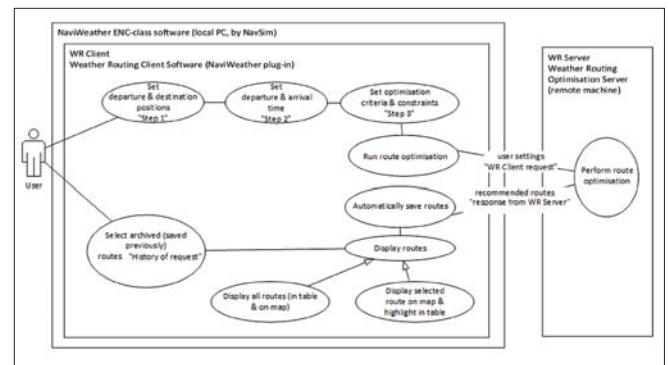

Fig. 4. WR Client - Use Case diagram

Setting up new route optimisation parameters can be done in three steps, in a set of configuration windows (Fig. 5). In the first step, the user selects the departure and destination positions. In the second step, the user sets the departure time, ship's draft (AP and FP), metacentric height (GMt) and option Shaft generator ON/OFF. In the third step, the user selects voyage objectives from the so-called checklist (passage time, total fuel consumption, risk index), the constraints (lateral accelerations, motion sickness incidence, rolling amplitude, slamming probability index, green water probability index, propeller emergence probability index, and excessive wave height) and advanced settings (setting the range of minimum and maximum values for the objectives and boundary thresholds for the constraints). After setting the route optimisation parameters, the user approves and sends a request by clicking the 'Finish' button. Before sending the request, the availability of the Internet connection is checked. If there is no connection, an error message will be displayed. Then the user waits for a response from the optimisation server (WR Server). The server responds to the WR Client with a set of candidate ship routes, depending on the weather forecast being considered. All the candidate routes are automatically saved on a local PC. The requested results are displayed in the form of a table and a navigation chart. In this table, users have access to information about the details of each candidate shipping route, including the objective values (passage time, fuel consumption and risk index) among others. The user can display the selected route on the map by clicking on the selected row from this table. The user always has access to previous inquiries through the "History of request" sub-menu.

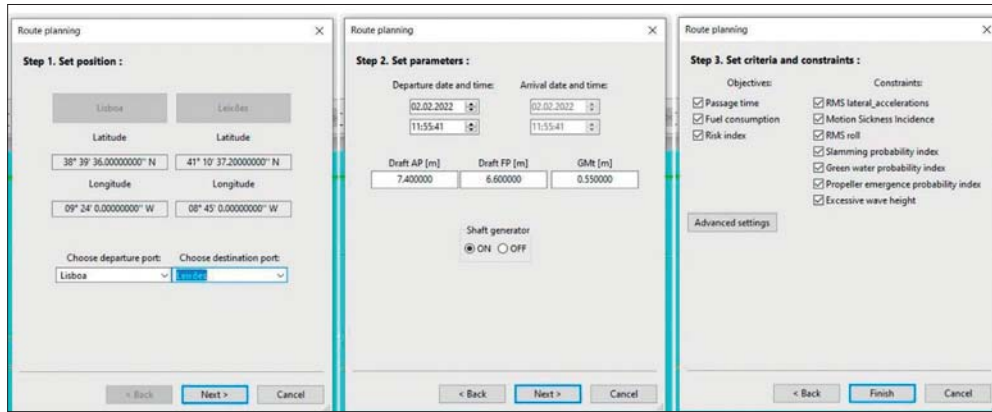

Fig. 5. WR Client - route optimisation wizard: step 1 – step 3

SERVER-SIDE APPLICATION (WR SERVER)

WR Server is a server-side console application that is responsible for handling route optimisation requests sent by WR Client via the client-server data exchange protocol. Evolutionary multi-objective optimisation (with constraints) is applied to solve the optimisation problem defined by the given request. The MultiObjective Evolutionary Algorithm based on Decomposition (MOEA/D) [28] was implemented as the core evolutionary optimiser and the w -dominance [29] method was additionally applied to limit the number of resulting routes. W -dominance allows the shaping of the policy of finding non-dominated routes (in the Pareto sense) by using w_{min} and w_{max} coefficient boundaries, defined for each optimisation objective by the user in the WR Client application.

WR Server continuously monitors the database and reacts as follows:

- if there is a new request: it handles it, sends the results back to the database and gets back to check for new requests;
- if there is no new request: it waits idly for a predefined (configurable) amount of time and then gets back to check for new requests.

It is crucial for WR Server to have the recent weather forecast for each request handled. Thus, a mechanism has been developed to automate downloading weather forecasts by a Windows PowerShell script. The script is run periodically (every 6 hours) using the Microsoft Windows Server 2016 task schedule. The most important element of this algorithm is a token that controls file processing. The token is used to avoid WR Server using forecasts that are just being downloaded or overwritten by the script.

OPTIMISATION OF ONBOARD DATA TRANSMISSION

The primary role of the vessel's hybrid communication module is to provide cost-effective and redundant data communication services for the exchange of weather data. To compare onboard transmission means, Table 1 presents the communication costs per 10 MB, using the prices as of December 2021, based on airtime contracts offered by local

internet providers. The values for Wi-Fi and GSM are based on internet subscription contracts for Poland, while satellite communication costs are based on global MSRPs airtime rates. The wi-fi connection is unmetered (unlimited bandwidth for a flat fee). GSM internet connection is metered but with a relatively high inclusive data packet of 5 GB. The satellite connection is metered at 200 KB intervals, with an inclusive 1.5 GB monthly allowance.

Tab. 1. Communication costs per 10 MB for Wi-Fi, GSM, and satellite communication modules

Communication module	Estimated coverage / range (in meters)	Cost of 10 MB
Wi-Fi (2.4 GHz)	100 m	< \$0.01
GSM (3G/4G LTE)	5000 m	< \$0.05
Satellite communication (Inmarsat I-4 Fleetbroadband)	global	~\$100.00

When designing the communication system, the objective was twofold. First, the aim was to minimise communication costs, setting the highest connection priority for the least expensive means (i.e. Wi-Fi) and the lowest priority for the most expensive (i.e. satellite communication). Besides assigning the lowest priority to the satellite communication node, we also used real-time network monitoring and strict firewall rules to pass through only whitelisted communications. The second aim was to minimise the recovery time needed to restore Client/Server online communication. Because Ethernet does not allow rings or loops in the network (as this would result in network flooding), the developed network infrastructure had to account for that particular setback to maintain the default data path.

The hybrid nature of the onboard communication module combines the three following communication sub-modules (Fig. 6):

- satellite broadband communication in the 1525-1661 MHz band (Inmarsat broadband services);
- global system for mobile communication (GSM) in the 700-4000 MHz band (3G/4G network);
- wireless network protocols at 2.4 GHz (Wi-Fi network).

All three communication sub-modules are connected to the central controller unit, which manages, switches and

prioritises each of the sub-modules. The central controlling unit firmware is based on embedded Linux. One of the core features developed for this project was the implementation of the WAN standby and fail-over mechanism to a secondary and tertiary network connection. Data exchange between the Client and the Server is based on TCP/IP, which accounts for the retransmission of lost packets and the correct sequencing of Ethernet frames.

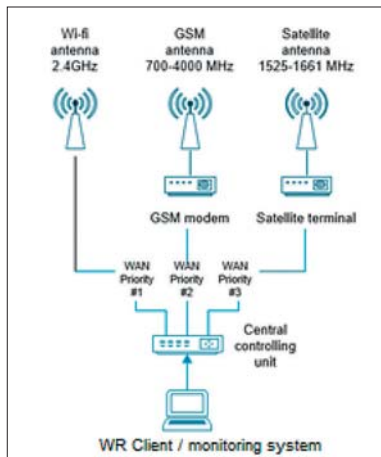

Fig. 6 Key elements of the hybrid communication system

Based on pre-determined priorities (1 = Wi-Fi; 2 = GSM, 3 = satellite communication; the lower number assigned, the higher the priority), the central controller unit performs cyclical fail-over tests to verify the Online/Offline status for each of the WAN interfaces. The fail-over detection is based on a health-check test using the ping method, which is initiated every 10 seconds for each of the WAN interfaces. To increase test reliability, WAN interfaces are tracked against three well-known IP addresses. The health-check ‘while loop’ breaks when one of the tracked IPs is offline (pingTestResults=False for a given IP address). Five consecutive health-check test breaks for a WAN results in a switch to a lower connection priority (e.g. from GSM to satellite communication), while one successful health-check is required to switch back to a higher priority (e.g. from satellite communication to GSM).

As the Client/Server communication in this application is less time-critical, the implemented solution is oriented at minimising data transmission costs. Therefore, in practice, the vessel’s hybrid communication system uses:

- Wi-Fi sub-module in harbour and harbour vicinity areas;
- GSM communication sub-module in coastal and approach waters;
- satellite sub-module when navigating open seas.

Such a functional and technical approach to the problem of data communication at sea enabled us to develop a relatively affordable ship-to-shore communication system, capable of providing weather data continuously, regardless of the vessel’s geographical position.

DEPLOYMENT OF THE SYSTEM ONBOARD A DEMONSTRATION SHIP

The system was installed onboard the demonstration ship ‘Monte da Guia’ in 2021. Deployment of the system was divided into stages driven by the technical aspects, ship accessibility in Portuguese ports and ongoing COVID-19 restrictions. At first, elements of the monitoring sub-system were installed and run element-by-element. In June 2021, when the onboard monitoring was almost fully operational, a module minimising data transmission costs was installed onboard, together with the client side of the route optimisation (WR Client). For the first few months, WR Client was working onboard ‘Monte da Guia’ in a limited offline mode, focusing on collecting user preferences and operational ship data, in order to tune the ship’s modelling on the server-side. After the ship model was updated with some necessary modifications to the server-side software (WR Server), the remote route optimisation procedure was available by the end of 2021. The system was then operational until the end of the presentation period (the end of February 2022), with short breaks caused by the external unavailability of onboard Internet (both GSM and Inmarsat). An example of the results obtained by the route optimiser for the demonstration ship model are presented in Fig. 7.

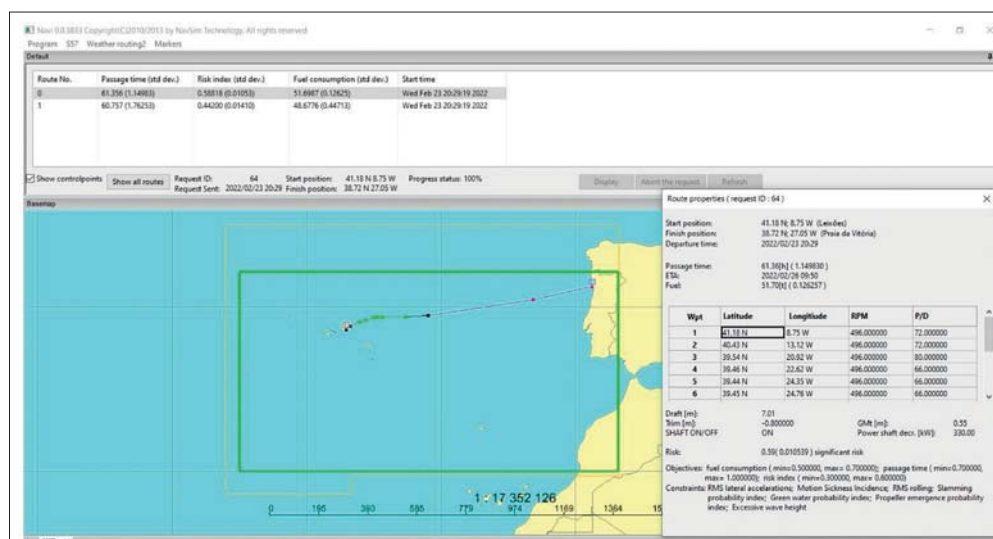

Fig. 7 Example results (displayed in WR Client) of route optimisation: Leixões – Praia da Vitória, departure 23th Feb 2022

CONCLUSIONS

The architecture of a computer-based system primarily describes its structure, intercommunication procedures, data sources and (possibly) storage strategies. It can heavily influence how the system would cope with typical, as well as unexpected, technological difficulties. Furthermore, it supports or limits the possible further development of the system.

As for the system being described here, its modular structure enables the possibility of development by improving or replacing selected modules. Client-server architecture in the route optimiser primarily reallocates all of the necessary high-tech resources (fast and robust processors, a significant amount of memory, large weather forecast files, etc.) needed for multi-objective optimisation on the server-side, leaving the onboard client with only simple software for collecting a request and displaying the optimisation results. Moreover, it allows for operational server-side updates and restarts without disturbing the system or the end-user.

In the current version of the system, the ship's model is updated via onboard collection and processing of data and semi-manual tuning of the meta-model. In future, this approach should be replaced by a fully automatic ship model update, utilising Artificial Neural Networks (ANN). The first attempts towards this goal have already been documented in [30] and [31].

ACKNOWLEDGEMENTS

This research was supported by The National Centre for Research and Development in Poland and by the Portuguese Foundation for Science and Technology (Fundação para a Ciência e Tecnologia - FCT) under grants from the ROUTING research project (MARTERA-1/ROUTING/3/2018) in the ERA-NET COFUND MarTERA-1 programme (2018-2021).

This work contributes to the Strategic Research Plan of the Centre for Marine Technology and Ocean Engineering (CENTEC), which is financed by the Portuguese Foundation for Science and Technology (Fundação para a Ciência e Tecnologia - FCT) under contract UIDB/UIDP/00134/2020.

REFERENCES

1. R. W. James, *Application of wave forecast to marine navigation*. US Naval Oceanograph, 1957.
2. H. Hagiwara and J. A. Spaans, "Practical Weather Routing of Sail-assisted Motor Vessels," *J. Navig.*, vol. 40, no. 01, pp. 96–119, Jan. 1987, doi: 10.1017/S0373463300000333.
3. C. Chen, S. Shiotani, and K. Sasa, "Numerical ship navigation based on weather and ocean simulation," *Ocean Eng.*, vol. 69, pp. 44–53, 2013, doi: 10.1016/j.oceaneng.2013.05.019.
4. W. Shao, P. Zhou, and S. K. Thong, "Development of a novel forward dynamic programming method for weather routing," *J. Mar. Sci. Technol.*, vol. 17, no. 2, pp. 239–251, 2012, doi: 10.1007/s00773-011-0152-z.
5. R. Zacccone, E. Ottaviani, M. Figari, and M. Altosole, "Ship voyage optimisation for safe and energy-efficient navigation: A dynamic programming approach," *Ocean Eng.*, vol. 153, pp. 215–224, 2018, doi: 10.1016/j.oceaneng.2018.01.100.
6. G. Mannarini, G. Coppini, P. Oddo, and N. Pinardi, "A Prototype of Ship Routing Decision Support System for an Operational Oceanographic Service," *TransNav, Int. J. Mar. Navig. Saf. Sea Transp.*, vol. 7, no. 1, pp. 53–59, 2013, doi: 10.12716/1001.07.01.06.
7. G. Mannarini, L. Carelli, J. Orović, C. P. Martinkus, and G. Coppini, "Towards least-CO2 ferry routes in the Adriatic sea," *J. Mar. Sci. Eng.*, vol. 9, no. 2, pp. 1–15, 2021, doi: 10.3390/jmse9020115.
8. M. Zyczkowski, P. Krata, and R. Szłapczyński, "Multi-objective weather routing of sailboats considering wave resistance," *Polish Marit. Res.*, vol. 25, no. 1, pp. 4–12, 2018, doi: 10.2478/pomr-2018-0001.
9. M. Zyczkowski and R. Szłapczyński, "Multi-Objective Weather Routing of Sailing Vessels," *Polish Marit. Res.*, vol. 24, no. 4, 2017, doi: 10.1515/pomr-2017-0130.
10. M.-C. Tsou, "Integration of a Geographic Information System and Evolutionary Computation for Automatic Routing in Coastal Navigation," *J. Navig.*, vol. 63, no. 02, pp. 323–341, 2010, doi: 10.1017/S0373463309990385.
11. L. Skoglund, J. Kuttenukeuler, and A. Rosén, "A new method for robust route optimisation in ensemble weather forecasts," 2012.
12. J. Hinnenthal and G. Clauss, "Robust Pareto-optimum routing of ships utilising deterministic and ensemble weather forecasts," *Ships Offshore Struct.*, vol. 5, no. 2, pp. 105–114, 2010, doi: 10.1080/17445300903210988.
13. J. Szłapczyńska, "Multi-objective Weather Routing with Customised Criteria and Constraints," *J. Navig.*, vol. 68, pp. 338–354, 2015, doi: 10.1017/S0373463314000691.
14. R. Vettor and C. Guedes Soares, "Development of a ship weather routing system," *Ocean Eng.*, vol. 123, no. January 2018, pp. 1–14, 2016, doi: 10.1016/j.oceaneng.2016.06.035.
15. R. Vettor, J. Szłapczyńska, R. Szłapczyński, W. Tycholiz, and C. Guedes Soares, "Towards Improving Optimised Ship Weather Routing," *Polish Marit. Res.*, vol. 27, no. 1, pp. 60–69, Mar. 2020, doi: 10.2478/pomr-2020-0007.
16. W. Kazimierski and N. Wawrzyniak, "Exchange of navigational information between VTS and RIS for inland

- shipping user needs,” *Commun. Comput. Inf. Sci.*, vol. 471, pp. 294–303, 2014, doi: 10.1007/978-3-662-45317-9_31.
17. Y. Zhang, A. Zhang, D. Zhang, Z. Kang, and Y. Liang, “Design and Development of Maritime Data Security Management Platform,” *Appl. Sci.*, vol. 12, no. 2, 2022, doi: 10.3390/app12020800.
 18. M. A. Hinostroza and C. Guedes Soares, “Parametric estimation of the directional wave spectrum from ship motions,” *Trans. R. Inst. Nav. Archit. Part A Int. J. Marit. Eng.*, vol. 158, no. December, pp. A121–A130, 2016, doi: 10.3940/rina.2016.a2.356.
 19. Davis, “Wireless Vantage Pro2 & Vantage Pro2 Plus Stations (6152,6153,6162,6163),” vol. 2. 2010, [Online]. Available: http://www.weathershop.com/Specs/6152-62-53-63_VP2Spec_C.pdf.
 20. Davis, “Integrated Sensor Suite.” [Online]. Available: https://cdn.shopify.com/s/files/1/0515/5992/3873/files/07395-333_IM-6322C-6334.pdf.
 21. Davis, “WEATHER LINK Software User’s Guide.” [Online]. Available: http://www.davis-tr.com/Downloads/WeatherLink_for_Windows_4.0_7862_Instruction_Manual.pdf.
 22. Katronic, “KATflow 100 Standard Clamp-On Ultrasonic Flow Transmitter,” 2018. http://www.em-solutions.co.uk/upload/product/pdf/1420207860katflow_100_cost_effective_clamp-on_flow_meter.pdf.
 23. Four-Faith, “Four-Faith. F8L10T – LoRa Terminal.” pp. 10–12, [Online]. Available: <https://en.four-faith.com/uploadfile/2018/0913/20180913113549104.pdf>.
 24. Four-Faith, “F8936-L Series Router User Manual.” <https://en.four-faith.com/uploadfile/2017/0309/20170309105843459.pdf>.
 25. RockTest, “Vibrating Wire Surface Strain Gauge (Model SM-5A), RockTest Instruction Manual,” 2005, [Online]. Available: <https://smartec.ch/wp-content/uploads/sites/2/2017/01/SM-5-Manual.pdf>.
 26. RockTest, “RT-VLOG - VW Datalogger,” [Online]. Available: <https://roctest.com/wp-content/uploads/2017/01/E50374-160815-RT-VLOG.pdf>.
 27. RockTest, “RT-VLOG, Instruction Manual.” 2009, [Online]. Available: https://roctest.com/wp-content/uploads/2017/01/RT-VLOG_E1374-180514-1.pdf.
 28. Q. Zhang and H. Li, “MOEA/D: A Multiobjective Evolutionary Algorithm Based on Decomposition,” *IEEE Trans. Evol. Comput.*, vol. 11, no. 6, pp. 712–731, Dec. 2007, doi: 10.1109/TEVC.2007.892759.
 29. R. Szlapczynski and J. Szlapczynska, “W-dominance: Tradeoff-inspired dominance relation for preference-based evolutionary multi-objective optimisation,” *Swarm Evol. Comput.*, vol. 63, no. March 2020, p. 100866, 2021, doi: 10.1016/j.swevo.2021.100866.
 30. P. Krata, A. Kniat, R. Vettor, H. Krata, and C. Guedes Soares, “The Development of a Combined Method to Quickly Assess Ship Speed and Fuel Consumption at Different Powertrain Load and Sea Conditions,” *TransNav, Int. J. Mar. Navig. Saf. Sea Transp.*, vol. 15, no. 2, pp. 437–444, 2021, doi: 10.12716/1001.15.02.23.
 31. L. Moreira, R. Vettor, and C. Guedes Soares, “Neural network approach for predicting ship speed and fuel consumption,” *J. Mar. Sci. Eng.*, vol. 9, no. 2, pp. 1–14, 2021, doi: 10.3390/jmse9020119.

CONTACT WITH THE AUTHORS

Joanna Szłapczyńska

e-mail: j.szlapczynska@wn.umg.edu.pl
Gdynia Maritime University,
Faculty of Navigation
POLAND

Roberto Vettor

e-mail: roberto.vettor@centec.tecnico.ulisboa.pt
Centre for Marine Technology
and Ocean Engineering (CENTEC),
Instituto Superior Técnico, Universidade de Lisboa
PORTUGAL

Rafał Szłapczyński

e-mail: rafal.szlapczynski@pg.edu.pl
Gdańsk University of Technology,
Faculty of Mechanical Engineering and Ship Technology
POLAND

Mirosław Łącki

e-mail: m.lacki@wn.umg.edu.pl
Gdynia Maritime University,
Faculty of Navigation
POLAND

Marcin Życzkowski

e-mail: marzyczk@pg.edu.pl
Gdańsk University of Technology,
Faculty of Mechanical Engineering and Ship Technology
POLAND

Miguel A. Hinostroza

e-mail: Miguel.Hinostroza@tecnico.ulisboa.pt
Centre for Marine Technology
and Ocean Engineering (CENTEC),
Instituto Superior Técnico, Universidade de Lisboa
PORTUGAL

Fernando P. Santos

e-mail: fernando.santos@centec.tecnico.ulisboa.pt
Centre for Marine Technology
and Ocean Engineering (CENTEC),
Instituto Superior Técnico, Universidade de Lisboa
PORTUGAL

Wojciech Tycholiz

e-mail: wojtek.tycholiz@navsim.pl
NavSim sp. z .o.o, Poland
POLAND

C. Guedes Soares

e-mail: c.guedes.soares@centec.tecnico.ulisboa.pt
Centre for Marine Technology
and Ocean Engineering (CENTEC),
Instituto Superior Técnico, Universidade de Lisboa
PORTUGAL