

**Original Study**
**Open Access**

B. Kirtimayee\*, Narendra Kumar Samadhiya

# Behavior of Vertically Confined Square Footing on Reinforced Sand under Centric Inclined Loading

<https://doi.org/10.2478/sgem-2022-0012>

received November 26, 2021; accepted May 20, 2022.

**Abstract:** This study presents the behavior of vertically confined square footing on geogrid- reinforced sand under centric inclined loading through a series of experimental tests. The load was applied at  $5^\circ$ ,  $10^\circ$  and  $20^\circ$  angles of inclination with the vertical. The tests were conducted on surface footing, footing with confiner and footing with confiner and horizontal reinforcement configurations subjected to inclined loading. Parametric variations like depth of the confiner ( $d=1B$ ,  $1.5B$ ,  $2B$ ), number of geogrid layers ( $N$ ; varies with variation in depth of confiner), and spacing between horizontal reinforcements ( $Y=0.25B$ ,  $0.5B$ ,  $0.75B$ ,  $1B$ ) have been investigated at the top surface dimension of confiner ( $D$ ) as  $1.0B$ ,  $1.5B$  and  $2.0B$  (where  $B$  is the width of the model footing). Results show that combined effect of confiner and horizontal reinforcement increases the ultimate bearing capacity of footing significantly compared to only confiner for all angle of inclinations. It can also be observed that load bearing capacities decrease with increase in angles of inclination and record the minimum improvement at  $20^\circ$  angle of inclination. Improvement in bearing capacities and reduction in settlement of footing analyzed in terms of bearing capacity ratio (BCR) and settlement reduction factor (SRF) are compared for all footing configurations. To summarize, the test results showed that confiner along with reinforcement can be considered as an economic ground improvement technique for shallow foundations to counter against heavily inclined loading.

**Keywords:** Centric inclined loading; load intensity; settlement; geogrid; sand; square footing.

## 1 Introduction

Bearing capacity and settlement are the two most essential foundation behavior considered in the field of geotechnical engineering. Shallow foundations such as isolated and square footings are widely used in transmitting loads from super structures to the supporting soil. In addition to vertical load, foundations are often subjected to moment and shear caused by forces such as earth pressure, wind, earthquake, water may be replaced by eccentric or inclined load resulting a reduction in load bearing capacity of footing. Earlier, a variety of methods were developed by the researchers to enhance the performance of geotechnical structures and soil characteristics. In some situations they are difficult to apply being prohibitively expensive and restricted by site conditions. Keeping economy in view, confinement technique is one of the suitably applicable methods that have been accepted to enhance the bearing capacity of footing and reduce settlement to permissible limit. In the past few years different materials such as geocell, un-plasticized polyvinyl chloride (Upvc) cylinder, semi flexible vertical reinforcement, mild steel casing, plastic hollow cylinder, timber box have been used as confiner and shown notable improvement in bearing capacity of footing ( Rajgopal et al. [25], Sawaaf and Nazer [30], Jha [18], Krishna et al. [21], Elsaied [13], Amarasinghe et al. [2]). Mandal and Manjunath [23] used geogrid and bamboo sticks as vertical reinforcement elements and studied their effect on the bearing capacity of a strip footing. Dehkordi and Karim [8] investigated the behavior of circular footing confined by rigid base and geocell reinforcement. Fattah et al. [14] studied the effect of bounded wall on rectangular footing resting on sandy soil. Effect of wraparound geo-synthetic reinforcement technique on ultimate bearing capacity of strip footing resting on soil bed was studied by Raja and Shukla [26]. Eid et al. [12] carried out both physical and numerical modeling on behavior of shallow foundation resting on laterally confined sand surrounded by sheet-pile walls to support excavation sides of sand underlain by a rock bed. Singh et al. [32] concluded through a series of laboratory model tests that soil confinement has a significant effect

\*Corresponding author: B. Kirtimayee, Department of civil Engineering, Indian Institute of Technology Roorkee (IITR), Roorkee-247667, India, E-mail: b.kirtimayee@ce.iitr.ac.in  
 Narendra Kumar Samadhiya, Department of Civil Engineering, Indian Institute of Technology Roorkee (IITR), Roorkee-247667, India

on the ultimate bearing capacity of square footing under eccentric-inclined loading.

On the other hand, an alternative method to improve the footing capacity is investigated by using skirts along each side of a foundation to provide a lateral confinement. Several researchers have highlighted the beneficial effect of these skirts by numerical and physical modeling (Bansby and Randolph [6], Yun and Bransby [35], Andersen et al. [3], Eid [11], Chen and Liu [7], Selmi et al. [31], Zeydi and Boushehrian [36], Al-Aghbari and Mohamedzein [1], Jiang et al. [19], Santhoshkumara and Ghosh [29], Barari et al. [4]). Saleh et al. [28] studied the behavior of skirted strip footing subjected to eccentric-inclined load considering various factor such as load inclination angles, skirt lengths and load eccentricities. Wakil [34] reported that the use of skirt increased the bearing capacity of footing up to 6.25% and also concluded that skirts are more beneficial in case of footing on loose sand than dense sand. Thakur and Dutta [33] used singly and doubly skirted shallow foundation on three different sand and reported noteworthy improvement in footing behavior. Ornek et al. [24] studied the effect of skirt shape on improvement of load-settlement characteristics of eccentrically loaded footing.

A study of the above literature reports that different materials have been used as confiners inserted alone under the footing subjected to mostly vertical loading. Effect of confiner under eccentric and inclined loading has not investigated extensively. It is seen that to date no study is performed to address the use of geogrid as vertical confinement with an extended parametric variation. In addition, it can also be observed that use of confiner along with reinforcement is very much limited. The work reported herein investigates the performance of vertically confined square footing resting on multi layered reinforced medium dense sand subjected to inclined loading. In the present study biaxial geogrid has been used both as a confiner and as a horizontal reinforcement under the square footing subjected to an extended variation of load inclination angle. Performance of confiner with and without reinforcements has been assessed. The purpose of this study is to analyze the effect of geogrid confiner and reinforcement by a thorough parametric variation for each application of the inclined load. The improvement in bearing capacity and reduction in settlement are quantified using two non-dimensional parameters called bearing capacity ratio (BCR) and settlement reduction factor (SRF), which are compared for all footing configurations.

## 2 Laboratory model test

### 2.1 Test Details

Geogrid reinforced vertically confined foundation system has been investigated in the present experimental study. Fig.1 shows the schematic diagram of the experimental set up used in the laboratory. The model foundation bed was prepared in an iron tank. The test tank was rectangular having internal dimensions of 1.0 m × 1.0 m × 0.8 m (L×B×H). To avoid lateral deformation, the tank walls were braced with iron section outside. The test tank was provided with a loading frame to facilitate load application through a manually operated hydraulic jack. A precalibrated proving ring of 30 kN capacity was used in between the hydraulic jack and footing to measure the magnitude of transferred load. A square footing of side B (20 cm) was used. The responses of the loading foundation were monitored at different loading stages by recording the footing settlement with the help of four dial gauges having an accuracy of 0.01 mm placed at the four corners of the footing. Average of four dial gauge readings was taken as the settlement of the footing. The parameters D, d, L, y and Y are the top surface dimension of the confiner, depth of the confiner, length of the geo-grid, depth of the top layer of reinforcement below the footing and spacing between the reinforcement layers respectively. Medium dense sand was used for carrying out the experimental work.

### 2.2 Materials used in the laboratory study

#### 2.2.1 Sand

The sand was collected locally from the Solanipuram river bed, Roorkee (India). It was properly sundried and made free of impurities. Tests like sieve analysis, relative density, specific gravity and direct shear, were conducted on the sand sample to obtain its physical and strength properties. Fig. 2 shows the particle size distribution curve for sand. It has been classified as SP as per the IS:1498 [17]. The angle of shearing resistance ( $\phi$ ) was obtained by conducting direct shear test on sand compacted at a dry unit weight of 15.24 kN/m<sup>3</sup>. It was found to be 32.6°. The physical properties of the sand are listed in Table 1.

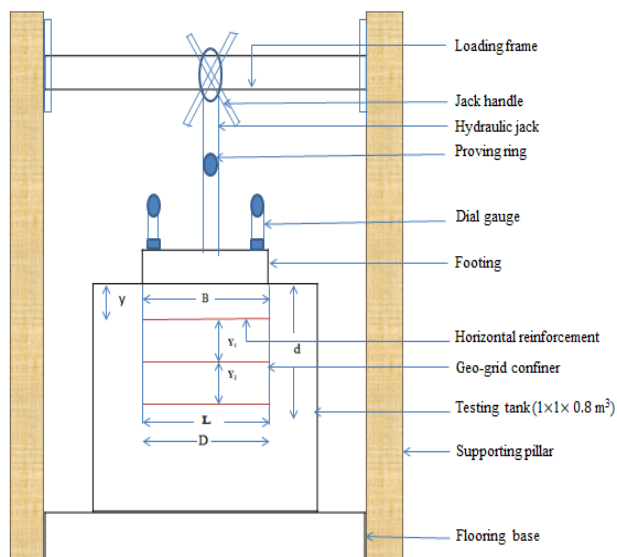

Figure 1: Schematic diagram of the experimental set up.

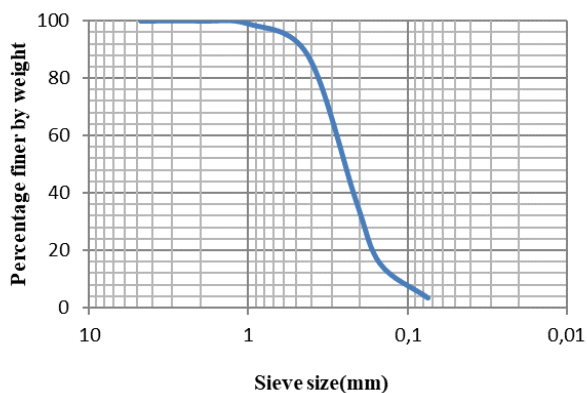

Figure 2: Particle size distribution curve.

2.2.2 Geogrid

A biaxial geogrid with an aperture size (25×25mm) was used as confiner and horizontal reinforcements. Geogrids are made up of polypropylene polymer with a junction efficiency 93% and 1.76mm rib thickness. The tensile strengths at 2% and 5% strain are 9.5 kN/m and 19.5kN/m respectively, where as the ultimate tensile strength is 29 kN/m. The physical and strength properties of biaxial geogrids used in the experimental work had been collected from the manufacturer. Geogrid pieces were cut from the sheet as per the specified required dimensions and tied by a binding wire to form the confiners. To prepare the horizontal reinforcements, geogrids were cut in desired size as plates. Fig. 3 shows a pictorial presentation of the confiner and reinforcement used in the experimental study.

Table 1: Properties of sand.

Material (sand)	Value
Classification of sand As per ISSCS ( Indian Standard Soil Classification)	SP
Specific gravity	2.64
Coefficient of curvature( $C_u$ )	1.13
Uniformity coefficient( $C_u$ )	2.62
Maximum void ratio( $e_{max}$ )	0.87
Minimum void ratio( $e_{min}$ )	0.55
Natural void ratio( $e_{natural}$ )	0.68
Maximum dry unit weight (kN/m <sup>3</sup> )	16.46
Minimum dry unit weight (kN/m <sup>3</sup> )	13.62
Natural dry unit weight (kN/m <sup>3</sup> )	15.24
Angle of shearing resistance( $\phi$ ) (Direct Shear Test)	32.6°
Relative Density	50%

3 Test program and methodology

3.1 Experimental details

A detailed investigation program was executed to find out the effect of confiner and confiner with horizontal reinforcement on the behavior of footing. Tests were performed in three series. In series A, only footing (surface footing) was used under centric inclined loading. In series B, footing with confiner was used, In series C, footing with confiner and horizontal reinforcements placed inside the confiner was tested under inclined loading. Parameters such as d, D, y, L and Y were normalized with respect to width of the footing (B). The top reinforcement layer (y) was kept at 0.1B (constant) below the base of the footing for all the tests. The consecutive horizontal reinforcement layer spacing was varied as 0.25B, 0.5B, 0.75B and 1.0B. For each top surface dimension of the confiner (D) that is 1.0B, 1.5B and 2.0B the normalized confiner depth (d/B) was varied as 1.0, 1.5 and 2.0 respectively. The details of laboratory model tests are presented in Table 2. Schematic presentation of the confiner and confiner with reinforcement under centric inclined load with different geometric parameters has been shown in Fig. 4.

3.2 Preparation of sand bed

The sand used for the foundation bed in the experimental work was properly sun dried, cleaned and sieved through

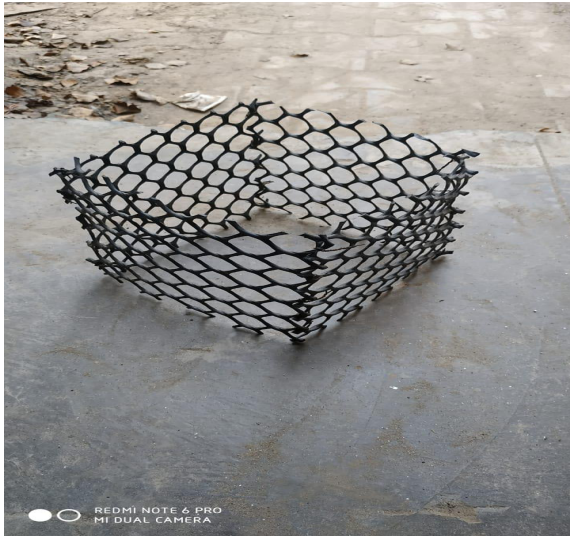

(a)

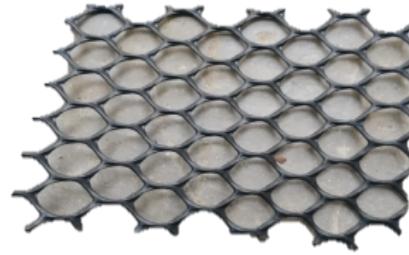

(b)

**Figure 3:** Geogrid used in the experimental study as (a) confiner (b) reinforcement.

a 1-mm IS sieve. A predetermined amount of sand for a particular volume was filled in the test tank using the raining technique. For sand raining technique the required height of fall to achieve the desired relative density of 50% was determined through several trials. In this study, the sand was poured slowly within the tank by a steel container from a fixed height of 25-cm and leveled by a wooden plate in each 10-cm height marked on the side of the tank to ensure that equal quantity of sand was being filled corresponding to 50% relative density. The quantity of sand was calculated multiplying the unit weight of sand with volume and for each lift, the amount of sand required to produce the desired unit weight ( $15.24 \text{ kN/m}^3$ ) was weighed for the correctness of each layer (10 cm). The uniformity of sand bed was checked for unit weight determination by collecting the soil sample in small containers where as the thickness of sand bed was checked from the depth difference inside the tank for each lift with the help of a measuring tape.

### 3.3 Placement of confiner and horizontal reinforcement

Confiners were placed on the leveled sand bed, each time considering the desired depth of the confiner. The concentricity of confiner with the tank was thoroughly checked with the help of a plumb bob. After the confiner was placed in position, horizontal geogrid reinforcements were placed inside the confiner followed by the simultaneous filling and leveling of sand based on the

required spacing. After the entire entity of confiner and reinforcement was placed, the remaining part of the sand layer was filled following the earlier procedure used for sand bed preparation. The same method was also used for individual placement of confiners on the sand bed for different footing configurations.

### 3.4 Test procedure

After the sand bed was prepared, the top surface of the sand bed was thoroughly leveled and the footing was placed exactly at the centre of the level surface with the help of a plumb bob. The footing was loaded with a hand operated hydraulic jack supported against reaction frame. Recess was made on the footing plate to accommodate ball bearing, through which centric inclined load was applied in small increments. A precalibrated proving ring was used to measure the transferred load. Each load increment was maintained constant until footing settlement was stabilized. Settlement of the footing was calculated as the average of four dial gauges arranged on each corner of the footing plate. The same procedure was followed till the complete collapse of the footing. Fig. 5 shows the experimental set up for centric inclined loading at  $5^\circ$  angle of inclination.

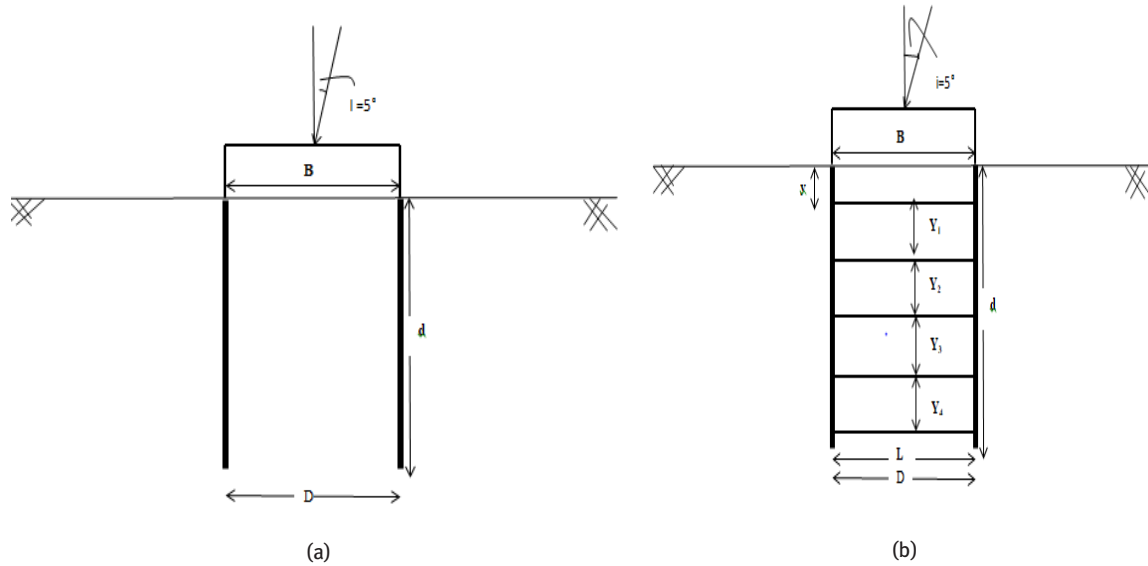

Figure 4: Schematic presentation of footing with (a) confiner (b) confiner with reinforcements under centric inclined load.

Table 2: Details of laboratory model tests,

Test series	Foundation configuration	Test parameters		Number of tests
		Variable	Constant	
A	Only footing (surface footing)	$i=0,5^{\circ},10^{\circ},20^{\circ}$		4
B	Footing with confiner	$d/B=1,1.5,2$ $i=5^{\circ},10^{\circ},20^{\circ}$	$D/B=1.0$	9
		$d/B=1,1.5,2$ $i=5^{\circ},10^{\circ},20^{\circ}$	$D/B=1.5$	9
		$d/B=1,1.5,2$ $i=5^{\circ},10^{\circ},20^{\circ}$	$D/B=2.0$	9
C	Footing with confiner and reinforcement	$d/B=1,1.5,2; N=1-8$ $Y/B=0.25,0.5,0.75,1$ $i=5^{\circ},10^{\circ},20^{\circ}$	$D/B=1.0, L/B=1, y/B=0.1B$	36
		$d/B=1,1.5,2; N=1-8$ $Y/B=0.25,0.5,0.75,1$ $i=5^{\circ},10^{\circ},20^{\circ}$	$D/B=1.5, L/B=1.5, y/B=0.1B$	36
		$d/B=1,1.5,2; N=1-8$ $Y/B=0.25,0.5,0.75,1$ $i=5^{\circ},10^{\circ},20^{\circ}$	$D/B=2.0, L/B=2.0, y/B=0.1B$	36

## 4 Results and Discussion

The present study aims at the analysis of load intensity-settlement behavior of vertically confined square footing under reinforced sand under centric inclined loading. The load intensity is same as the bearing pressure of footing used by several authors earlier (Khing et al. [20], Dixit and Patil [10], Kumar and Saran [22], Biswas et al. [5]). A comparison of bearing capacity for various footing

configurations under centric inclined loading has also been conducted. Two non dimensional terms, namely BCR and SRF are used to quantify the performance improvement in bearing capacity due to the inclusion of confiner and reinforcement layers. BCR is defined as the ratio of footing ultimate bearing load intensity for reinforced sand ( $Q_{\text{reinforced}}$ ) to footing ultimate bearing load intensity for unreinforced ( $Q_{\text{unreinforced}}$ ) sand. The ultimate load intensities for footing-soil system have been



Figure 5: Experimental set up for 5° angle of inclination.

obtained from load intensity-settlement curves at 25mm settlement (IS:1888 [16], Harikumar et al. [15]). The SRF can be calculated as (Roy and Deb [27], Demir et al. [9]) as follows:

$$BCR = \frac{Q_{\text{reinforced}}}{Q_{\text{unreinforced}}} \quad (1)$$

$$SRF = 1 - \frac{SR_R}{SR_{UR}} \quad (2)$$

where  $(SR)_{UR}$  = settlement ratio (SR) of the unreinforced sand bed; and  $(SR)_R$  = settlement ratio (SR) of the reinforced sand bed at a bearing pressure corresponding to  $(SR)_{UR}$ . In the present study, SRF is calculated at a bearing pressure corresponding to the 12.5% SR of the unreinforced sand bed i.e 25-mm settlement. It can be noted that the ratio of footing settlement to footing width is defined as the settlement ratio and is expressed in percentage. An attempt is also made on bringing out the effect of confiner and reinforcement on square footing at highly inclined loading. Accordingly, detailed analysis has been provided in the subsequent sections.

#### 4.1 Effect of confiner without reinforcement

Effect of confiner on the behavior of square footing without reinforcement has been analyzed at different depths and top surface dimension of confiner. The load intensity-settlement curves for footing with confiner

configurations under centric inclined loading ( $i=5^\circ$ ) are presented in Fig. 6. Load intensities corresponding to 25 mm settlement for all footing configurations are tabulated in Table 3. It can be observed from Fig. 6 that with increase in confiner depth load bearing capacity of footing increases and records the highest value at  $d/B = 2.0$  for each increment in top confiner dimension. The optimum improvement in load intensity with increment in confiner depth is noticed for minimum top surface dimension of confiner  $D/B = 1.0$  which gradually decreases with increment in top surface dimension of confiner. It is evident from Table 3 that ultimate load obtained at  $d/B = 2.0$  are 89%, 61% and 42% compared to surface footing for top surface dimension of  $1B, 1.5B$  and  $2B$  respectively at applied load of  $5^\circ$  angle of inclination. Same trend of increment in bearing capacity is also observed for  $10^\circ$  and  $20^\circ$  angle of inclination too, while it can be noticed that improvement becomes marginal for  $20^\circ$  angle of inclination due to sliding and heavy lateral displacement of sand particles. The BCR and SRF calculated using Eqs (1) and (2) are presented in Tables 4 and 5 respectively. It can be observed from both the tables that the BCR and SRF values increased with increase in depth of confiner and showed the optimum value at  $d/B = 2.0$  for all variations of top surface of confiner. This is explained as follows. The installation of confiner resists the lateral movement of sand particles beneath the footing leading to increase in stiffness of the sand and modification of failure mode. As the  $d/B$  ratio increases the confining pressure also increases at the confiner tip level, Consequently elastic and plastic displacement of sand grains get constrained leading to a greater increase in load carrying capacity and considerable decrease in settlement.

#### 4.2 Effect of confiner with reinforcement

The behavior of vertically confined square footing with reinforcement under centric inclined loading is investigated in this section. Typical load intensity-settlement plots for a particular confiner dimension at  $5^\circ, 10^\circ$  and  $20^\circ$  angles of inclination are shown in Fig. 7. Ultimate load intensities corresponding to 25 mm settlement for all footing- confiner- reinforcement arrangements are presented in Table 3. Analysis of Table 3 shows that the bearing capacities of surface footing are  $35.45 \text{ kN/m}^2, 34.19 \text{ kN/m}^2$  and  $31.80 \text{ kN/m}^2$  respectively for inclined loading of  $5^\circ, 10^\circ$  and  $20^\circ$  angle of inclinations. This bearing capacity value at  $d/B = 1.0, 1.5$  and  $2.0$  increased to  $79.93, 101.74$  and  $105.96 \text{ kN/m}^2$  respectively at  $5^\circ$  angle of inclination, for minimum spacing of  $0.25B$  between

**Table 3:** Ultimate load intensity for different footing configurations under centric inclined loading.

Footing configuration	Confiner dimension	Horizontal reinforcement Spacing (Y)	Load intensity (kN/m <sup>2</sup> ) (i=5°)	Load intensity (kN/m <sup>2</sup> ) (i=10°)	Load intensity (kN/m <sup>2</sup> ) (i=20°)
Surface footing			35.45	34.19	31.80
Footing with confiner	D/B = 1.0; d/B = 1.0		50.06	47.98	33.77
	D/B = 1.0; d/B = 1.5		59.55	53.04	34.94
	D/B = 1.0; d/B = 2.0		67.02	57.42	35.18
	D/B = 1.5; d/B = 1.0		48.91	46.52	32.81
	D/B = 1.5; d/B = 1.5		53.45	48.59	33.71
	D/B = 1.5; d/B = 2.0		57.1	50.81	34.49
	D/B = 2.0; d/B = 1.0		46.43	44.25	30.56
	D/B = 2.0; d/B = 1.5		48.61	46.49	30.87
Footing with confiner and horizontal reinforcement	D/B = 1.0; d/B = 1.0	0.25B	79.93	69.64	59.47
		0.5B	73.13	62.94	54.29
		0.75B	62.56	50.83	45.59
		1B	55.55	48.49	42.49
	D/B = 1.0; d/B = 1.5	0.25B	101.74	83.16	76.10
		0.5B	90.5	80.28	71.39
		0.75B	84.37	66.57	57.39
		1B	70.9	60.45	50.09
	D/B = 1.0; d/B = 2.0	0.25B	105.96	91.54	84.89
		0.5B	90.5	85.12	78.49
		0.75B	85.78	77.34	69.69
		1B	78.43	64.82	51.29
	D/B = 1.5; d/B = 1.0	0.25B	120.20	102.30	83.42
		0.5B	96.21	89.0	73.4
		0.75B	82.13	76.39	59.55
		1B	61.10	59.40	53.64
	D/B = 1.5; d/B = 1.5	0.25B	171.10	146.44	102.47
		0.5B	110.0	94.42	77.89
		0.75B	82.51	80	69.47
		1B	62.80	61.76	54.31
	D/B = 1.5; d/B = 2.0	0.25B	213.91	195.31	127.29
		0.5B	138.75	118.91	98.01
		0.75B	85.52	82.6	73.67
		1B	62.80	65	60.91
D/B = 2.0; d/B = 1.0	0.25B	136.0	110.53	102.44	
	0.5B	102.91	91.71	86.11	
	0.75B	87.22	84.23	74.23	
	1B	75.54	73.4	57.89	
D/B = 2.0; d/B = 1.5	0.25B	177.62	146.0	114.9	
	0.5B	123.8	100.5	92.9	
	0.75B	91.1	85.12	76.38	
	1B	80.0	75.23	66.41	
D/B = 2.0; d/B = 2.0	0.25B	228.22	188.57	134.39	
	0.5B	151.10	143.72	102.2	
	0.75B	111.21	102.66	86.14	
	1B	90.0	81.4	69.47	

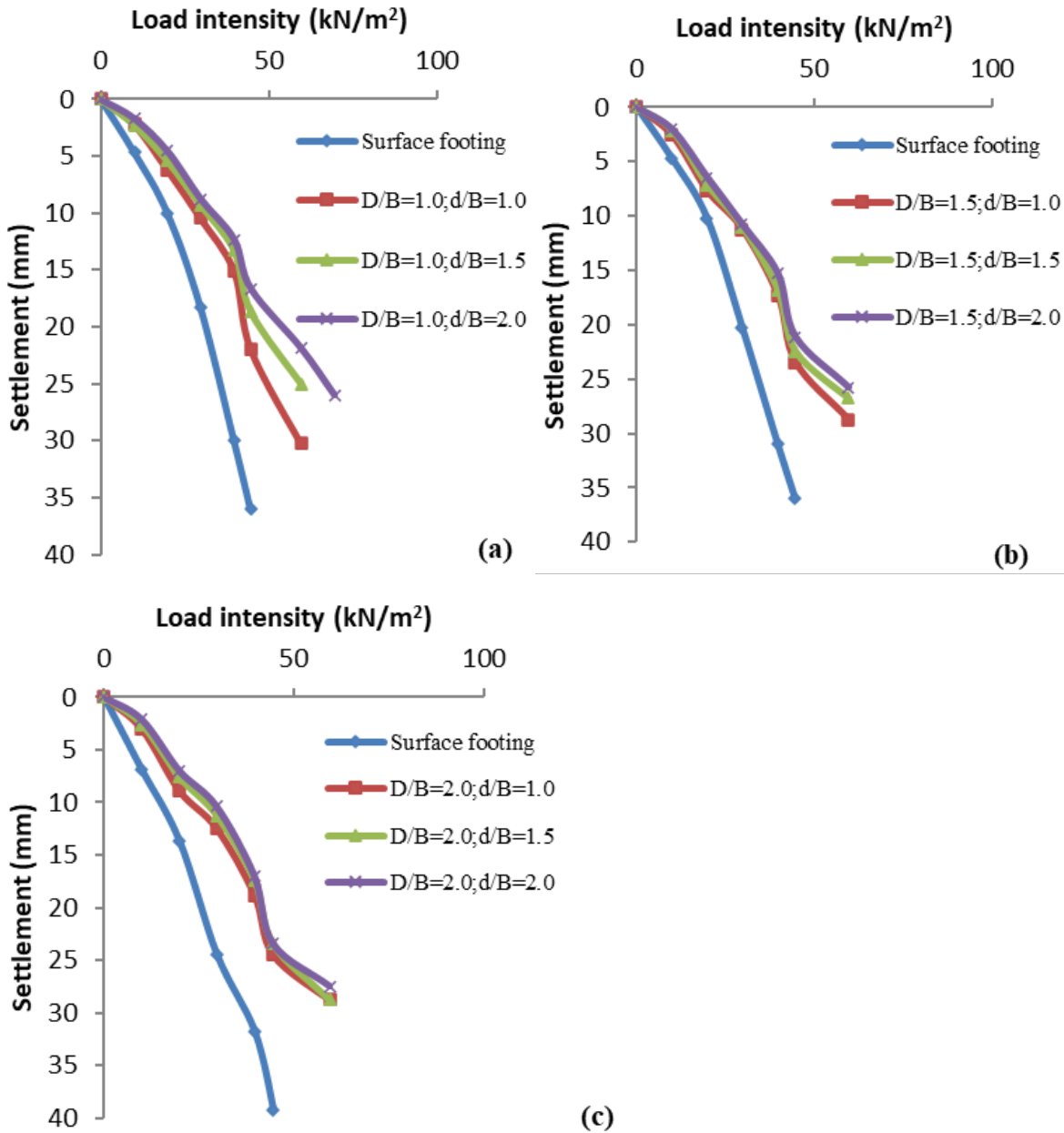

Figure 6: Load intensity- settlement behavior of footing with confiner at 5° angle of inclination for (a) D/B=1.0 (b) D/B=1.5 (c) D/B=2.0 with variation of d/B=1.0,1.5,2.0 respectively.

horizontal reinforcements and top confiner dimension of 1B. It is seen that with increase in confiner depth and for minimum reinforcement spacing the bearing capacity increases significantly for each top confiner dimension and registered the optimum value at D/B=2.0. The bearing capacity for the confiner configuration of D/B = 2.0 ; d/B = 2.0 and minimum reinforcement spacing of 0.25B are found as 228.22, 188.57 and 134.39 kN/m² at 5°, 10°, 20° angles of inclination respectively showing a significant improvement compared to the load bearing capacity of their respective surface footing. It may be due to the fact

that when horizontal reinforcements are placed at closer spacing like 0.25B inside the confiner, the interlocking between sand particles is increased, larger horizontal shear resistance is developed under footing due to interlocking between geogrids and sand particles, lateral displacement of soil is reduced considerably and the foundation soil system becomes stiffer due to strong bonding between soil particles. Further it can be observed that the BCR and SRF values as presented in Tables 4 and 5 respectively show a notable improvement with confiner and reinforcement. For the same confiner dimension (D/B=2.0; d/B = 2.0) and



**Table 4:** Comparison of BCRs for different footing configurations under centric inclined loading.

Footings configuration	Confiner dimension	Horizontal reinforcement Spacing (Y)	BCR (i=5°)	BCR (i=10°)	BCR (i=20°)
Surface footing					
Footings with confiner	D/B = 1.0; d/B = 1.0		1.41	1.4	1.10
	D/B = 1.0; d/B = 1.5		1.67	1.55	1.14
	D/B = 1.0; d/B = 2.0		1.89	1.67	1.15
	D/B = 1.5; d/B = 1.0		1.37	1.36	1.07
	D/B = 1.5; d/B = 1.5		1.5	1.42	1.1
	D/B = 1.5; d/B = 2.0		1.61	1.48	1.13
	D/B = 2.0; d/B = 1.0		1.3	1.29	1.0
	D/B = 2.0 ; d/B = 1.5		1.37	1.35	1.01
	D/B = 2.0; d/B = 2.0		1.42	1.38	1.02
Footings with confiner and horizontal reinforcement	D/B = 1.0; d/B = 1.0	0.25B	2.25	2.04	1.95
		0.5B	2.06	1.84	1.73
		0.75B	1.76	1.48	1.49
		1B	1.56	1.41	1.39
	D/B = 1.0; d/B = 1.5	0.25B	2.87	2.43	2.5
		0.5B	2.55	2.35	2.34
		0.75B	2.38	1.95	1.88
		1B	2.00	1.77	1.64
	D/B = 1.0; d/B = 2.0	0.25B	3.00	2.68	2.78
		0.5B	2.55	2.49	2.57
		0.75B	2.42	2.26	2.28
		1B	2.21	1.90	1.68
	D/B = 1.5; d/B = 1.0	0.25B	3.39	3.0	2.74
		0.5B	2.71	2.61	2.41
		0.75B	2.31	2.23	1.95
		1B	1.72	1.73	1.76
	D/B = 1.5; d/B = 1.5	0.25B	4.82	4.29	3.36
		0.5B	3.1	2.76	2.55
		0.75B	2.32	2.33	2.28
		1B	1.77	1.8	1.78
	D/B = 1.5; d/B = 2.0	0.25B	6.03	5.71	4.18
		0.5B	3.91	3.47	3.21
		0.75B	2.41	2.41	2.42
		1B	1.91	1.9	2.0
D/B = 2.0; d/B = 1.0	0.25B	3.83	3.23	3.36	
	0.5B	2.9	2.68	2.82	
	0.75B	2.45	2.46	2.43	
	1B	2.12	2.14	1.9	
D/B = 2.0; d/B = 1.5	0.25B	5.0	4.27	3.77	
	0.5B	3.49	2.93	3.05	
	0.75B	2.56	2.48	2.5	
	1B	2.25	2.19	2.18	
D/B = 2.0; d/B = 2.0	0.25B	6.43	5.51	4.41	
	0.5B	4.25	4.2	3.35	
	0.75B	3.13	3.0	2.82	
	1B	2.54	2.38	2.28	

BCR: bearing capacity ratio

**Table 5:** Comparison of SRF for different footing configurations under centric inclined loading.

Footing configuration	Confiner dimension	Horizontal reinforcement Spacing (Y)	SRF (i=5°)	SRF (i=10°)	SRF (i=20°)
Surface footing					
Footing with confiner	D/B = 1.0; d/B = 1.0		0.47	0.43	0.10
	D/B = 1.0; d/B = 1.5		0.54	0.48	0.14
	D/B = 1.0; d/B = 2.0		0.57	0.52	0.18
	D/B = 1.5; d/B = 1.0		0.41	0.36	0.06
	D/B = 1.5; d/B = 1.5		0.43	0.40	0.08
	D/B = 1.5; d/B = 2.0		0.46	0.50	0.10
	D/B = 2.0; d/B = 1.0		0.36	0.35	0.003
	D/B = 2.0 ; d/B = 1.5		0.41	0.39	0.01
	D/B = 2.0; d/B = 2.0		0.43	0.44	0.02
Footing with confiner and horizontal reinforcement	D/B = 1.0; d/B = 1.0	0.25B	0.67	0.63	0.60
		0.5B	0.54	0.53	0.52
		0.75B	0.44	0.43	0.37
		1B	0.39	0.36	0.31
	D/B = 1.0; d/B = 1.5	0.25B	0.74	0.64	0.65
		0.5B	0.70	0.60	0.63
		0.75B	0.62	0.50	0.49
		1B	0.53	0.42	0.41
	D/B = 1.0; d/B = 2.0	0.25B	0.86	0.84	0.78
		0.5B	0.71	0.65	0.64
		0.75B	0.63	0.58	0.58
		1B	0.54	0.46	0.43
	D/B = 1.5; d/B = 1.0	0.25B	0.80	0.73	0.68
		0.5B	0.66	0.64	0.59
		0.75B	0.56	0.54	0.52
		1B	0.45	0.35	0.41
	D/B = 1.5; d/B = 1.5	0.25B	0.89	0.85	0.73
		0.5B	0.78	0.70	0.66
		0.75B	0.64	0.58	0.55
		1B	0.51	0.46	0.43
	D/B = 1.5; d/B = 2.0	0.25B	0.90	0.86	0.79
		0.5B	0.77	0.73	0.69
		0.75B	0.64	0.59	0.55
		1B	0.59	0.43	0.42
	D/B = 2.0; d/B = 1.0	0.25B	0.80	0.79	0.79
		0.5B	0.71	0.71	0.69
		0.75B	0.66	0.64	0.57
		1B	0.61	0.55	0.49
D/B = 2.0; d/B = 1.5	0.25B	0.89	0.83	0.78	
	0.5B	0.77	0.77	0.72	
	0.75B	0.69	0.68	0.64	
	1B	0.62	0.59	0.51	
D/B = 2.0; d/B = 2.0	0.25B	0.90	0.88	0.80	
	0.5B	0.85	0.80	0.76	
	0.75B	0.72	0.71	0.65	
	1B	0.60	0.59	0.52	

SRF: settlement reduction factor

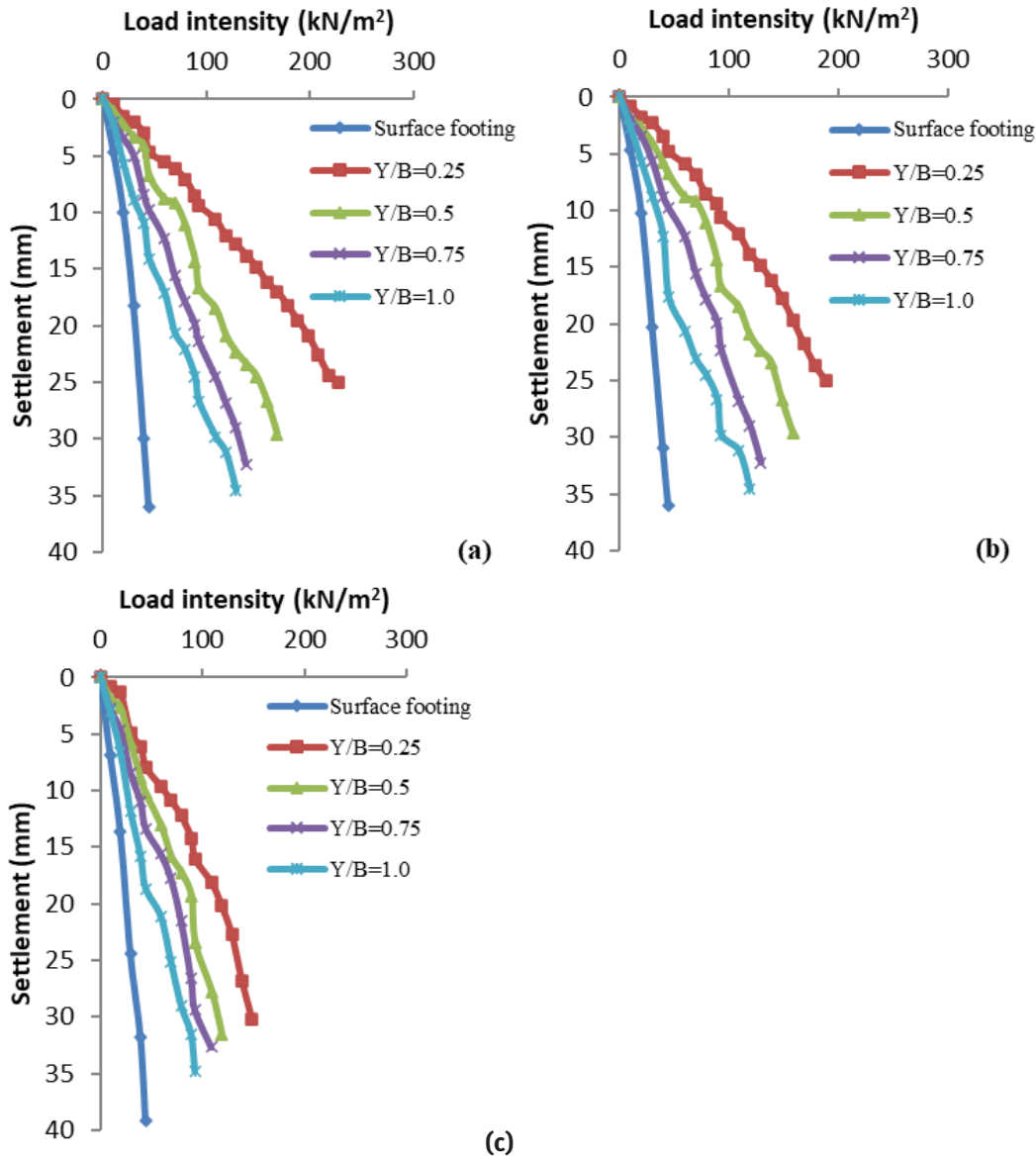

**Figure 7:** Load intensity-settlement behavior of footing with confiner ( $D/B=2.0$ ;  $d/B=2.0$ ) and reinforcement (a)  $5^\circ$  (b)  $10^\circ$  (c)  $20^\circ$  angle of inclination.

reinforcement spacing ( $0.25B$ ) the reduction settlement is found to be 90%, 88% and 80% at  $5^\circ$ ,  $10^\circ$  and  $20^\circ$  angles of inclination. From the above analysis it can be inferred that use of confiner and reinforcement together has significant effect on improving bearing capacity and reducing settlement even at  $20^\circ$  angle of inclination.

### 4.3 Effect of depth and top surface dimension of confiner

A series of model tests in series B and C were carried out to verify the effect of depth and top surface dimension of

confiner on square footing under centric inclined loading. In both the series the top surface dimension of confiner ( $D$ ) was kept as  $1B$ ,  $1.5B$  and  $2.0B$  for variation of the depth of confiner  $d/B = 1.0, 1.5, 2.0$  respectively. It can be noticed from the test results of series B as mentioned in Table 3 that with increase in depth of confiner the bearing capacity of footing increases for each confiner dimension. The optimum value obtained at  $D/B = 1.0$  and  $d/B = 2.0$  further decreases as the  $D/B$  value increases to  $1.5B$  and  $2.0B$ . This behavior of confiner remains similar for all angles of inclination. The reason is attributed to a little larger aperture size of geogrid plates used as confiner which weakens down the lateral confinement with increase in

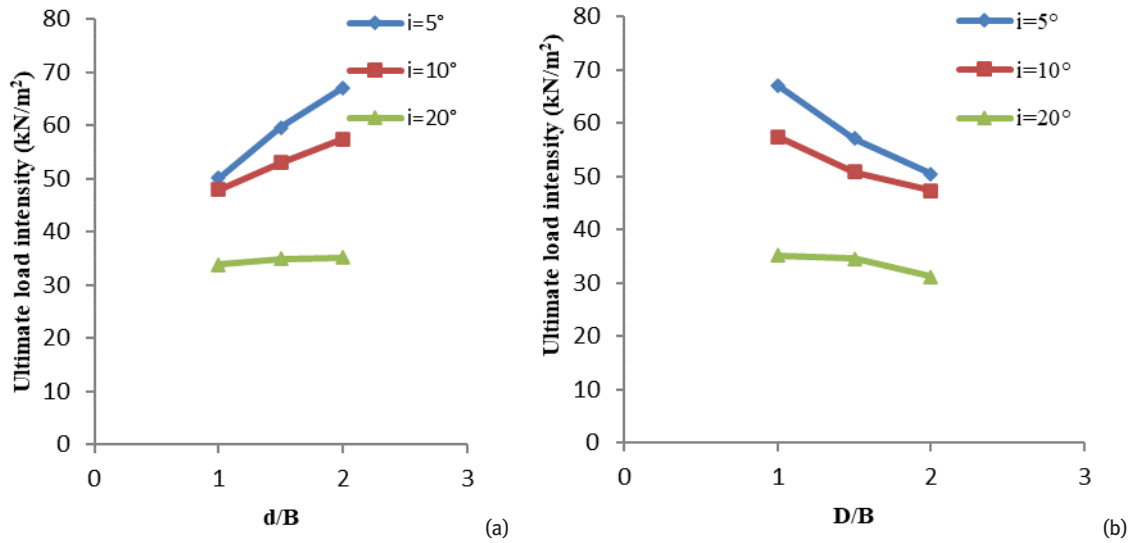

**Figure 8:** Variation of ultimate load intensity with normalized (a) depth of confiner at  $D/B = 1.0$  (b) top surface dimension of confiner at  $d/B = 2.0$  for footing with confiner configuration.

top surface dimension. Variation of ultimate load intensity with normalized depth ( $d/B$ ) and top surface dimension of confiner ( $D/B$ ) for all applied angles of inclination is presented in Fig. 8. Further analysis of Table 3 reveals that test results obtained in series C (confiner with reinforcement) show that the bearing capacity of footing increases significantly with increase in both confiner depth and top surface dimension and shows the optimum value at highest increment in top surface dimension, that is,  $D/B = 2.0$ . This can be explained, as the top surface dimension increases the length of reinforcements placed horizontally inside the confiner increases simultaneously, provides a larger area to spread the applied load. This is the reason, increment in top surface dimension becomes notably beneficial with reinforcements where as its effect becomes marginal when used alone as confiner.

#### 4.4 Effect of number of reinforcements and spacing between reinforcement layers

Analysis of Table 3 reveals that number of reinforcements and spacing between reinforcement layers play a vital role in enhancing load bearing capacity of footing. The spacing between the reinforcement layers was varied as 0.25B, 0.5B, 0.75B and 1B. It can be observed that with increase in confiner depth, the number of reinforcement layers increases and for minimum spacing between the layers it shows optimum improvement in bearing capacity as well as reduction in settlement for all top surface dimensions of the confiner. As the spacing between the geogrid layers

increases, bearing capacity starts decreasing gradually and the minimum improvement is observed at 1B spacing. It also shows that the increment in bearing capacity of footing for spacing of 0.75B and 1.0B remains marginal for all individual normalized confiner depths as the number of reinforcements placed inside the confiner is almost equal for both the spacing ratios which only show improvement with increase in confiner depth. This behavior of spacing remains the same for all angles of inclination of applied load even though a decrement in magnitude of bearing capacity is observed with increase in angles of inclination. Effect of spacing between reinforcement layers on the BCR and SRF values is shown in Fig. 9 for different angles of inclination. It is noticed from the figures that both BCR and SRF values decrease with increase in spacing and the lowest value is obtained at a spacing of 1B. From Table 3 it can also be seen that optimum increment in bearing capacity is observed at the inclusion of maximum number of reinforcements for a minimum spacing(0.25B) inside the confiner at  $d/B = 2.0$  ( $N = 8$ ) for all top surface dimensions which enables the footing to carry more load and reduce settlement even at  $20^\circ$  angle of inclination. This can be explained as follows: with the increase in number of geogrid the contact area between the geogrid layers and soil particles increases which strengthens the interlocking effect. Consequently larger horizontal shear resistance is developed under footing and lateral displacement of soil is reduced considerably due to confinement provided by the confiners. The load is transferred by geogrid layers to a larger soil mass. Therefore the failure wedge becomes larger and frictional resistance on the failure

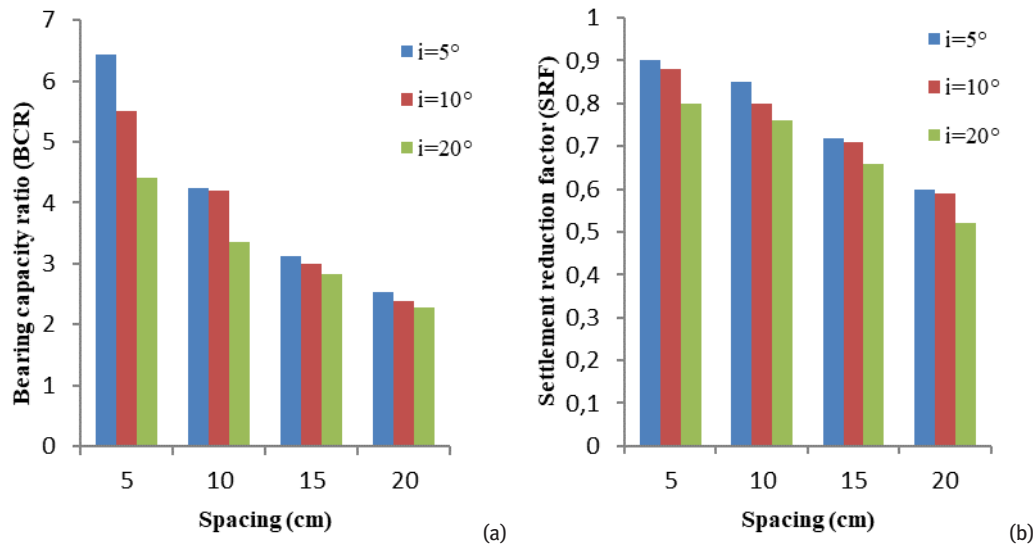

**Figure 9:** (a) Variation of bearing capacity ratio with spacing (b) variation of settlement reduction factor with spacing, at confiner dimension ( $D/B = 2.0$ ;  $d/B = 2.0$ ).

plane increases. This may be the reason due to which soil reinforcement enables the foundation to carry more load which gradually weakens down with increment in spacing between subsequent reinforcement layers.

The above study also showed that the optimum number of horizontal reinforcements is much dependent on the vertical spacing between the horizontal geogrid layers and placement of first layer of reinforcement. With increase in spacing between horizontal reinforcements, the number of reinforcement layers decreases in side the confiner for all confiner depths and shows the highest increment in bearing capacity and reduction in settlement at minimum spacing ( $0.25B$ ) by transfer superimposed load to a deeper depth where the confining and overburden pressure are higher. It is also recommended to arrange the reinforcement in the effective zone when placed under the footing for better results.

#### 4.5 Effect of inclined loading and angle of inclination

Effect of angle of inclination on vertically confined square footing on multi-layered geogrid-reinforced sand has been investigated through model test analysis. Ultimate bearing capacities of footing with different foundation configurations are presented in Table 3. These are 35.9, 35.4, 34.19, 31.8  $\text{kN/m}^2$  for surface footing at  $0^\circ$ ,  $5^\circ$ ,  $10^\circ$ ,  $20^\circ$  angles of inclination which shows a decrease in load bearing capacities with increase in angle of inclination. Similar trend has been observed for bearing capacity at

other footing configurations as evident from Table 3. A more detailed analysis of both the test series (B and C) shows that at  $20^\circ$  angle of inclination the effect of confiner underneath the footing shows almost marginal increment in bearing capacity, whereas confiner with reinforcements shows considerable improvement at the same angle of inclination. It can be observed from Table 3 that as the angle of inclination of the applied load increases the footing becomes more prone to sliding failure and loses contact with the supporting soil due to unequal pressure distribution, which is the primary reason for reduction in bearing capacity. It is found that this effect is more prominent on surface footing which gradually gets subsided to a greater extent with the use of confiner and reinforcements. This is attributed to the reason that with increase in top surface dimension of the confiner, the length of reinforcements increases which provides larger contact area to distribute the load and for minimum spacing shows optimum effect to counter against the failure due to incremented angle of inclination. It can be inferred from the above discussion that although the footing behavior gets affected due to increase in angle of inclination in case of surface footing and footing with confiner, the effect later counteracts well due to the combined effect of confiner and reinforcements and provides a significant improvement in footing bearing capacity and reduction in settlement.

## 5 Conclusions

In the present investigation, laboratory model tests were carried out to understand the behavior of vertically confined square footing on reinforced sand subjected to centric inclined loading. The effects of confiner with and without reinforcements were studied extensively through different parametric variations for all described footing configurations. More precisely variation in footing bearing capacity and settlement with geogrid confiner and reinforcements has been analyzed thoroughly with increase in angle of inclination of the applied load. The study reveals the following observations:

1. The ultimate bearing capacity of footing has shown significant improvement with a combined configuration of confiner and reinforcement under inclined loading. The bearing capacity of confined footing is found to increase with increase in confiner depth and the top surface dimension of confiner for a minimum reinforcement spacing. The optimum load intensity value reported at a confiner configuration of  $D/B = 2.0$ ;  $d/B = 2.0$  for a reinforcement spacing of  $0.25B$  is 535%, 451% and 323% that of surface footing at  $5^\circ$ ,  $10^\circ$  and  $20^\circ$  angles of inclination respectively.
2. The spacing between horizontal reinforcements has an important effect on enhancing the load bearing capacity and reducing settlement of the footing when placed within the confiner. The ultimate load intensity decreases when the vertical spacing between the horizontal reinforcements increases. It can be observed from the present study that spacing of  $0.75B$  and  $1.0B$  between the horizontal reinforcements has almost marginal increment on load intensity for all confiner depths considered.
3. The number of horizontal reinforcements which is dependent on the spacing between subsequent geogrid layers also plays a vital role in reducing the settlement of the footing thus improving the ultimate load bearing capacity. The optimum enhancement in load intensity has been observed with the maximum number of geogrid layers ( $N = 8$ ). However the improvement is quite notable in case of each increment in confiner depth and for minimum spacing.
4. Increase in the length of horizontal reinforcement layers provides a better stability to footing at incremented angle of inclination thus improving the footing behavior.
5. In case of footing with a confiner configuration the bearing capacity also shows a notable improvement with increase in confiner depth for each top surface dimension of the confiner (1B, 1.5B, 2B) while the

bearing capacity starts reducing with increment in surface dimension of confiner without reinforcement. In the present study at confiner dimension of  $D/B = 1.0$  and  $d/B = 2.0$  the optimum bearing capacity is registered. At the same confiner dimension the optimum reduction in settlement is observed as 57%, 52% and 18% at  $5^\circ$ ,  $10^\circ$  and  $20^\circ$  angles of inclination respectively.

6. As it can be observed from the test results, individual inclusion of confiner does not seem to have more significant improvement on the footing behavior with increase in load angle of inclination, therefore, it is recommended to use geo-synthetic sheet wrapped around the confiner to increase the efficiency of confiner for improved results.
7. Aperture size of geogrid has an important influence on the load intensity, especially when placed as a confiner alone under the footing. Secondly, the strength of geogrid should also be checked before using it as a confiner so that it can rigidly stand on the sand bed for better performance.
8. Overall it can be concluded that, even though the individual effect of confiner enumerates noteworthy improvements, provision of both confiner and reinforcement shows a significant effect on the behavior of footing under inclined loading for all angles of inclination. The footing performance with confiner and reinforcement observed at  $20^\circ$  angle of inclination ensures that geogrid confiner and reinforcement configuration can be considered as a useful method for footing under inclined loading.

**Funding:** Not applicable

**Conflicts of interest/Competing interests:** The authors declare that they have no known competing financial interests or personal relationships that could have appeared to influence the work reported in this article.

## References

- [1] Al-Aghbari, M.Y., Mohamedzein, Y.E.A. (2020). The use of skirts to improve the performance of a footing in sand, *Int J Geotech Eng*, 14(2), pp. 134-141. <https://doi.org/10.1080/19386362.2018.1429702>.
- [2] Amarasinghe, M.P., De Silva, L.I.N., Gallage, C. (2018). The effect of lateral confinement on the settlement characteristics of shallow foundations on sand, *Int J GEOMATE* 15(51), pp. 258-265.
- [3] Andersen, K.H., Jostad, H.P., Dyvik, R. (2008). Penetration resistance of offshore skirted foundations and anchors

- in dense sand, *J Geotech Geoenviron Eng*, 134(1), pp. 106-116. [https://doi.org/10.1061/\(ASCE\)1090-0241\(2008\)134:1\(106\)](https://doi.org/10.1061/(ASCE)1090-0241(2008)134:1(106)).
- [4] Barari, A., Ghaseminejad, V., Ibsen, L.B. (2021). Failure envelopes for combined loading of skirted foundations in layered deposits, *J Waterway, Port, Coastal, Ocean Eng* 147(4), pp.04021008. [https://doi.org/10.1061/\(ASCE\)WW.1943-5460.0000639](https://doi.org/10.1061/(ASCE)WW.1943-5460.0000639).
- [5] Biswas, A., Muralikrishna, A., Dash, S.K. (2016). Behavior of geo-synthetic reinforced soil foundation systems supported on stiff clay subgrade, *Int J Geomech*, 16(5), pp. 04016007. [https://doi.org/10.1061/\(ASCE\)GM.1943-5622.0000559](https://doi.org/10.1061/(ASCE)GM.1943-5622.0000559).
- [6] Bransby, M.F., Randolph, M.F. (1998). Combined loading of skirted foundations, *Geotechnique*, 48(5), pp. 637-655. <https://doi.org/10.1680/geot.1998.48.5.637>.
- [7] Chen, G., Liu, R. (2018). Upper bound solutions of vertical bearing capacity of skirted mudmat in sand, *Appl Ocean Res*, 73, pp. 100-106. <https://doi.org/10.1016/j.apor.2018.01.017>.
- [8] Dehkordi, P.F., Karim, U.F.A. (2020). Behaviour of circular footings confined by rigid base and geocell reinforcement, *Arab J Geosci*, 13, pp. 1100. <https://doi.org/10.1007/s12517-020-06092-1>
- [9] Demir, A., Laman, A., Yildiz, A., Ornek, M. (2013). Large scale field tests on geogrid reinforced granular fill underlain by clay soil, *Geotext Geomembr*, 38, pp. 1–15. <https://doi.org/10.1016/j.geotextmem.2012.05.007>.
- [10] Dixit, M.S., Patil, K.A. (2014) Effect of reinforcement on bearing capacity and settlement of sand, *Electron J Geotech Eng*, 19, pp. 1033-1046.
- [11] Eid, H.T. (2013). Bearing capacity and settlement of skirted shallow foundations on sand, *Int J Geomech*, 13(5), pp. 645-652. [https://doi.org/10.1061/\(ASCE\)GM.1943-5622.0000237](https://doi.org/10.1061/(ASCE)GM.1943-5622.0000237).
- [12] Eid, H.T., Alansari, O.A., Odeh, A.M., Nasr, M.N., Sadek, H.A. (2009). Comparative study on the behavior of square foundations resting on confined sand, *Can Geotech J*, 46(4), pp. 438–453. <https://doi.org/10.1139/T08-134>
- [13] Elsaied, A.E., Saleh, N.M., Elmashad, M.E. (2015). Behavior of circular footing resting on laterally confined granular reinforced soil, *HBRC j*, 11(2), pp. 240-245 <https://doi.org/10.1016/j.hbrj.2014.03.011>.
- [14] Fattah, M.Y., Shlash, K.T., Mohammed, H.A. (2014). Bearing capacity of rectangular footing on sandy soil bounded by a wall, *Arab J Sci Eng*, 39, pp. 7621–7633. <https://doi.org/10.1007/s13369-014-1353-7>.
- [15] Harikumar, H., Sankar, N., Chandrakaran, S. (2016). Behavior of model footing resting on sand bed reinforced with multidirectional element, *Geotext Geomembr*, 44, pp.568- 578. <http://dx.doi.org/10.1016/j.geotextmem.2016.03.008>.
- [16] IS 1888 (1982). Indian standard method of load test on soil, Bureau of Indian Standard, India.
- [17] IS 1498 (2007). Classification and identification of soils for general purposes, Bureau of Indian Standard, India.
- [18] Jha, J.N. (2007). Effect of vertical reinforcement on bearing capacity of footing on sand. *Indian Geotech J*, 37(1), pp. 64-78.
- [19] Jiang, C., Lin, L., Li, C., Li, T.B., He, J. (2020). The undrained vertical and horizontal bearing capacity of internal skirted foundation in clay, *Eur J Environ Civ*, 24(9), pp. 1302-1319. <https://doi.org/10.1080/19648189.2018.1463296>.
- [20] Khing, K.H., Das, B.M., Puri, V.K., Cook, E.E., Yen, S.C. (1993). The bearing capacity of a strip foundation on geogrid-reinforced sand, *Geotext Geomembr*, 12(4), pp. 351-361. [https://doi.org/10.1016/0266-1144\(93\)90009-D](https://doi.org/10.1016/0266-1144(93)90009-D).
- [21] Krishna, A., Viswanath, B., Keshav, N. (2014) Performance of square footing resting on laterally confined sand. *Int J Res Eng Tech* 3(6), pp. 110-114.
- [22] Kumar, A., Saran, S. (2003), Closely spaced strip footings on reinforced sand, *J Geotech Geoenviron Eng*, 129(7), pp. 660-664. [https://doi.org/10.1061/\(ASCE\)1090-0241\(2003\)129:7\(660\)](https://doi.org/10.1061/(ASCE)1090-0241(2003)129:7(660)).
- [23] Mandal, J.N., Manjunath, V.R. (1995) Bearing capacity of strip footing resting on reinforced sand subgrades, *Constr Build Mater*, 9(1), pp 35-38, [https://doi.org/10.1016/0950-0618\(95\)92858-E](https://doi.org/10.1016/0950-0618(95)92858-E).
- [24] Ornek, M., Calisici, M., Turedi, Y., Kaya, N. (2021). Investigation of skirt effect on eccentrically loaded model strip footing using laboratory tests. *J Soil Mech Foun Eng*, 58(3), pp. 215-222. <https://doi.org/10.1007/s11204-021-09731-1>
- [25] Rajagopal, K., Krishnaswamy, N.R., Latha, G.M. (1999). Behavior of sand confined with single and multiple geocells. *Geotext Geomembr* 17(3), pp. 171-184. [https://doi.org/10.1016/S0266-1144\(98\)00034-X](https://doi.org/10.1016/S0266-1144(98)00034-X)
- [26] Raja, M.N.A., Shukla, S.K. (2020). Ultimate bearing capacity of strip footing resting on soil bed strengthened by wraparound geo-synthetic reinforcement technique, *Geotext Geomembr*, 48, pp. 867-874, <https://doi.org/10.1016/j.geotextmem.2020.06.005>.
- [27] Roy, S.S., Deb, K. (2017). Bearing capacity of rectangular footings on multilayer geosynthetic-reinforced granular fill over soft soil, *Int J Geomech*, 17(9), pp. 04017069. [https://doi.org/10.1061/\(ASCE\)GM.1943-5622.0000959](https://doi.org/10.1061/(ASCE)GM.1943-5622.0000959).
- [28] Saleh, N.M., Alsaied, A.E., Elleboudy, A.M. (2008). Performance of skirted strip footing subjected to eccentric inclined load, *Electron J Geotech Eng*, 13, pp. 1-13.
- [29] Santhoshkumara G., Ghosh, P. (2020). Ultimate bearing capacity of skirted foundation on cohesionless soil using slip line theory, *Comput Geotech*, 123, pp. 103573. <https://doi.org/10.1016/j.compgeo.2020.103573>.
- [30] Sawwaf, M. El., Nazer, A. (2005). Behavior of circular footings resting on confined granular soil, *J Geotech Geoenviron Eng*, 131(3), pp 359-366. [https://doi.org/10.1061/\(ASCE\)1090-0241\(2005\)131:3\(359\)](https://doi.org/10.1061/(ASCE)1090-0241(2005)131:3(359)).
- [31] Selmi, M., Kormi, T., Hentati, A., Ali, N.B.H. (2019). Capacity assessment of offshore skirted foundations under HM combined loading using RFEM, *Comput Geotech*, 114, pp. 1-12. <https://doi.org/10.1016/j.compgeo.2019.103148>.
- [32] Singh, V. K., Prasad, A., Aggarwal, R.K. (2007). Effect of soil confinement on ultimate bearing capacity of square footing under eccentric–inclined load, *Electron J geotech Eng* 12, pp. 1-14.
- [33] Thakur, A., Dutta, R.K. (2020) Experimental and numerical studies of skirted hexagonal footings on three sands, *SN Appl Sci*, 2(3), pp. 1-11. <https://doi.org/10.1007/s42452-020-2239-9>.
- [34] Wakil, A.Z.EL. (2013). Bearing capacity of skirt circular footing on sand. *Alexandria Eng J* 52(3), pp. 359–364. <https://doi.org/10.1016/j.aej.2013.01.007>.
- [35] Yun, G., Bransby, M.F. (2007). The un-drained vertical bearing capacity of skirted foundations, *Soils Found*, 47(3), pp. 493-505. <https://doi.org/10.3208/sandf.47.493>.
- [36] Zeydi, H., Boushehrian, A.H. (2020). Experimental and numerical study of bearing capacity of circular footings on layered soils with and without skirted sand piles, *Iran J Sci Tech*, 44, pp. 949–958. <https://doi.org/10.1007/s40996-019-00284-w>.