

Received: 28 October 2019 / Accepted: 29 November 2019 / Published online: 20 December 2019

*ball screw, feed drive,
machine tool, modelling*

Jerzy JEDRZEJEWSKI^{1*}, Zbigniew KOWAL¹,
Wojciech KWASNY¹, Zdzislaw WINIARSKI¹

BALL SCREW UNIT PRECISE MODELLING WITH DYNAMICS OF LOADS AND MOVING HEAT SOURCES TAKEN INTO ACCOUNT

This paper deals with the precision modelling of the ball screw unit's thermal behaviour in the turning centre and its impact on the tool head positioning error. The error components along controllable axes X and Z are described in detail using an FE model integrating the changes in thermal and force loads and deformations occurring during the motion of the nut as a heat source. The impact of the nut work cycle on the thermal deformations of the ball screw and the displacements of the slideways and the screw points along both the axes and on carriage positioning precision is demonstrated.

1. INTRODUCTION

The accuracy and speed of positioning the machine tool assemblies moving along control axes, enabling the optimal realization of tool path components, is vital for machining accuracy and productivity. Deformations in feed drive unit components, such as bearings, the ball screw and shaft slideways and bodies affect this accuracy in a complex way, depending on the dynamically changeable friction forces, thermal loads and the static and dynamic loads.

The deformations result in positioning errors which need to be minimized and compensated. Error minimization and compensation are based on the accurate identification of error components and their interactions and on holistic modelling and numerical simulations. The behaviour of errors under time and space changeable loads in the specific operating conditions must be determined.

In order to efficiently correct errors and compensate them using CNC controller procedures relatively simple error functions should be formulated. Accurate holistic modelling is very useful for simplifying error functions for the specific operating conditions.

As examples of such functions, Jedrzejewski and Kwasny [1] described a function for ball screw shaft heating and nut axial thermal displacement during reciprocating motion at the feed speed of 30 m/min and a shift function for a high-speed (up to 50 000 rpm) spindle.

¹ Wroclaw University of Science and Technology, Department of Machine Tools and Mechanical Technologies, Wroclaw, Poland

* E-mail: jerzy.jedrzejewski@pwr.edu.pl
<https://doi.org/10.5604/01.3001.0013.6228>

The improvement of the operational properties of linear controllable axes based on ball screws (which owing to their simple design and low cost are commonly used in feed drives) has been the subject of numerous studies dealing with the following key problems:

- The ball screw power losses, heating up and positioning errors in operating conditions and their precise modelling and reduction. Attintas, Verl at al., [2] in a broad ball screw drive dynamics analysis concluded that thermal errors and errors caused by deformation require more holistic research. Jedrzejewski at al. [3] for CNC turning described the reasons for the assumptions and efficiency of the modelling of ball screw unit thermal deformation caused by a moving heat source (the nut). The axial thermal nut displacements, as a positioning error component, were estimated and it was concluded that more holistic and precise modelling is needed. Verl and Frey, [4] experimentally determined the changes in ball screw preload, motion, acceleration, torque and nut draw force in selected working cycles. The linear correlation between screw rotational speed and ball screw preloading was evaluated with the conclusion that the preload change gradient significantly influences the overall load. Unfortunately, the thermal impact was neglected. Winiarski at al. [5] presented a model of loads and power loss generation in a ball screw unit with interactions between the components in the operating conditions for working cycle long time conditioning. Temperatures and displacements (including changes in stiffness) were computed. The impact of high motion dynamics on the accurate estimation of nut and carriage positioning errors requires more holistic modelling and simulation.

- The modelling of the thermal deformations of ball screw under the assumption of a trapezoidal distribution of the heat flux (generated in the nut) in the screw shaft, based on measuring the distribution of temperature along the ball screw by means of thermo-couples, Wu and Kung [6]. However, this method of modelling is too complex and not precise enough. Heisel et al. [7] used infrared thermography to model the temperature distribution along the ball screw, but also this method turned out to be too complex and not precise enough. Only digital models are suitable for the fast modelling and simulation of ball screw thermal errors.

- The modelling of the thermal deformations of the ball screw, using a moving heat source model and simulations based on the trace of power losses in the ball screw unit's motor, Kim at al. [8]. This solution significantly improves the modelling process, but does not ensure the required accuracy of temperature estimation.

- The modelling of the ball screw thermal deformations with a moving heat source taken into account, using FEM and the renumbering of discretization nodes (Gleich, [9]). Unfortunately, the latter approach turns out to be too slow to be employed in machine tools thermal errors compensation at the current feed rates. Similar attempts for a moving headstock were made by (Grochowski and Jedrzejewski, [10]). Also in this case the renumbering of the discretization nodes when computing thermal deformations is too slow to be used in the error compensation function.

The principal limitations of the holistic modelling of ball screw positioning errors are its complexity, inadequate knowledge of the interactions between loads and deformations and the demand for very high computing power of the generally available computers. As a result, incomplete models are used in application research. This paper presents a holistic approach to the precise modelling of the thermal behaviour of the ball screw unit, using as an example an idling turning centre and the ABAQUS software and detailed load and deformation models.

Moving heat sources at high feed rates, static loads, thermal and dynamic loads, ball screw and changeable bearing preloads in the ball screw and in its supports and a variable work cycle are taken into account in the modelling, which goes significantly beyond the usual range of model research to date.

2. DISCUSSION OF DEFORMATIONS AND LOAD INFLUENCING BALL SCREW POSITIONING ERROR

Positioning errors along the controllable axes of the turning centre are the sum of the ball screw pitch error and the deformations of: the ball screw itself, the rolling screw-nut joint, the bearing sets, the front and back supports of the ball screw and the machine bed, and the ball screw unit body, expressed by their static, thermal and dynamic displacements. In order to forecast the deformations for an assumed feed mechanism work cycle one must identify the deformation generation mechanisms and take them into account in the simulation models. In thermal deformation models the mechanism of the thermal load caused by a moving heat source is particularly complex. The load changes over time with the operating conditions of the ball screw unit and depends on the variable friction forces on the slideways, and on the variable feed motion dynamics. This is accompanied by variable heat transfer conditions which need to be taken into account in the computational models.

It was found difficult to model the transfer of the tractive force effects on the assemblies of the whole mechanical structure of the feed drive for both the *X* and *Z* axes. The tractive force comprises the friction forces on the slideways, the forces of inertia of the shifted masses and the resistances to motion in the nut and in the ball screw bearings and depends on the feed motion direction and the instantaneous value of ball screw tension.

Figure 1 shows in detail the components of the load acting on the ball screw unit subassemblies, which have a direct and indirect bearing on positioning precision. Research on the accurate modelling of friction in rolling joints and on the modelling of contact deformations and heat transfer in such joints was done by Jędrzejewski and Maciolka, [11] and continues to be conducted.

Each component of the ball screw unit structure is assigned force loads having a direct or indirect bearing on the intensity of the heat sources active in the structure of the ball screw unit or being directly heat loads. For such loads as the ball screw preload and the friction force also the factors determining them in operating conditions are shown (column two). Column three contains thermal factors which have an influence on some of the load components presented in column two. The mathematical relations describing the loads need to be very precise in order to accurately model thermal loads and deformations.

For example, the power losses arising in the screw-nut joint used to be modelled under considerable simplifications, whereby it was impossible to precisely determine their instantaneous values at dynamically changing tractive force values.

Also the omission of the effect of bed and ball screw unit body deformations, which by causing displacements of the ball screw supports change the magnitude of the static loads and the thermal loads, was a gross simplification in earlier research. The thermal loads include the heat generated in the screw-nut joint and in the screw support bearings, as well as the heat transmitted to/from the environment.

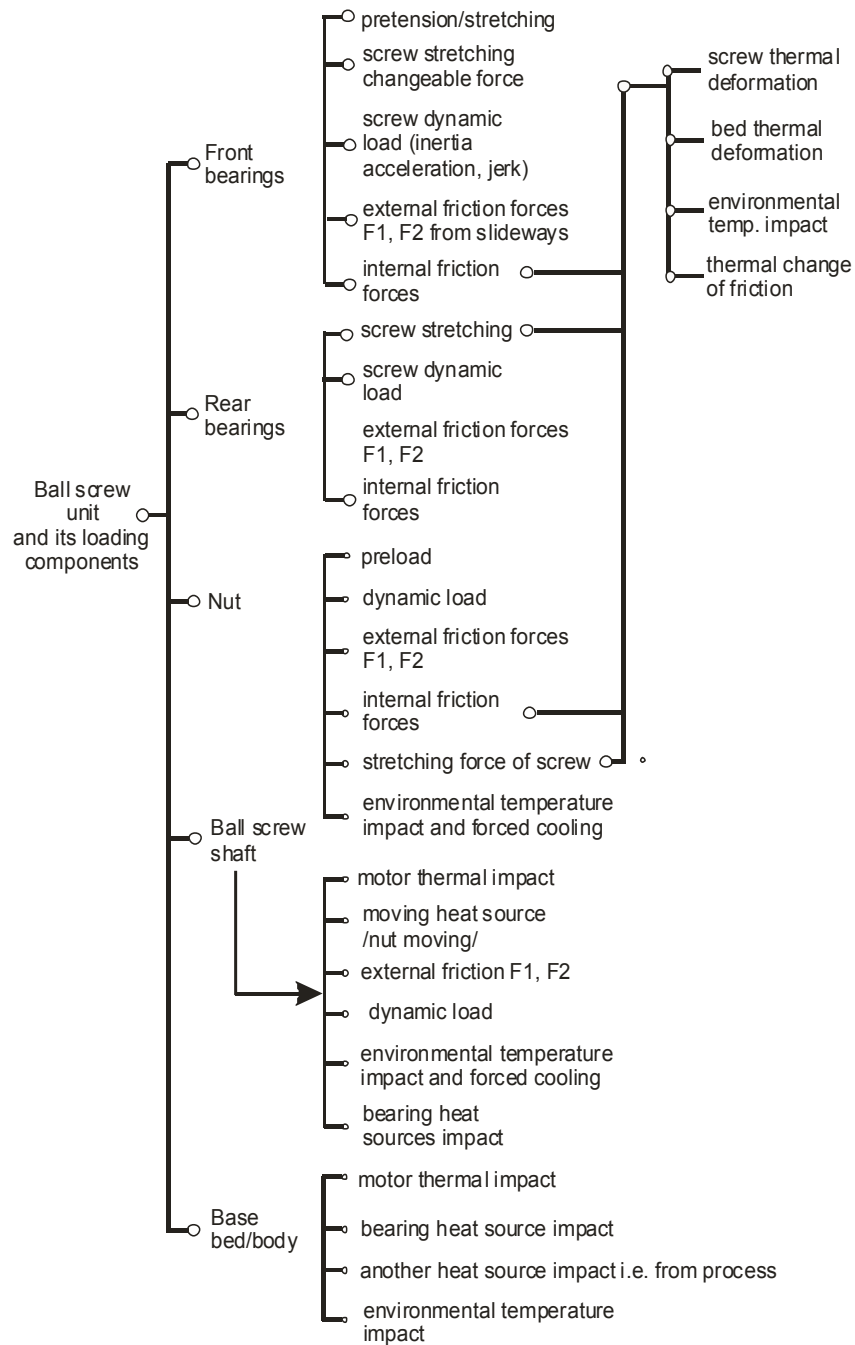

Fig. 1. Ball screw unit load components

3. RESULTS OF CALCULATIONS

3.1. SCREW-NUT POWER LOSSES

The subject of the holistic modelling was the turning centre structure, with a special focus on the ball screw based feed drive on the principal longitudinal axis Z and axis X of the carriage. A geometrical model of this structure is shown in Fig. 2. One can see the location of

the two feed mechanisms and the places in which the power losses and the deformations included in the modelling of positioning errors occur.

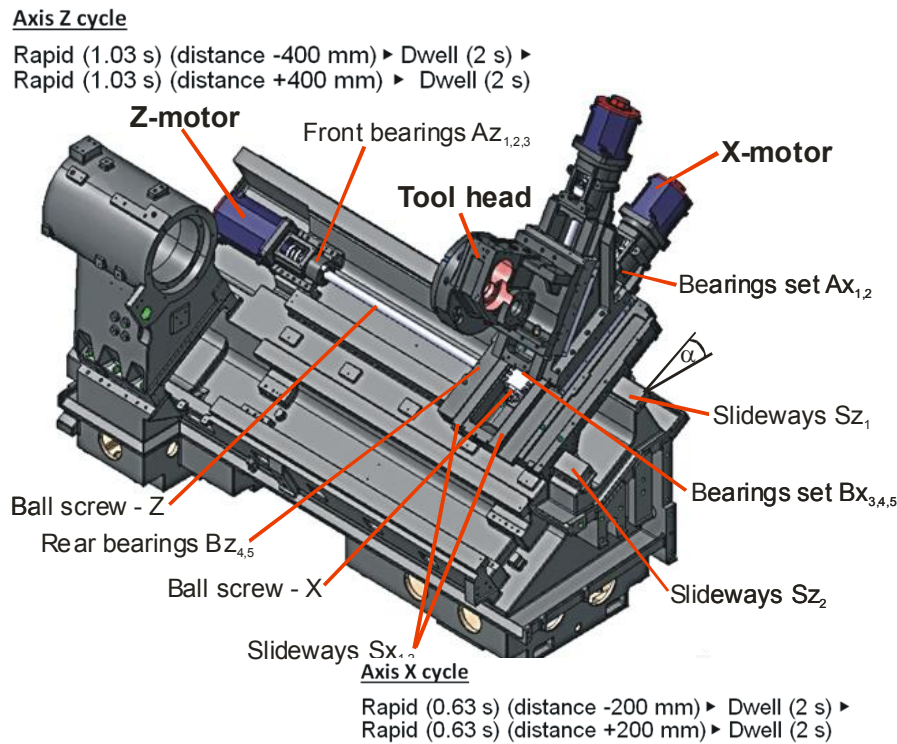

Fig. 2. Geometrical model of turning centre main structure bodies with feed drive units location

For both the axes the feed cycle includes: moving at the maximum speed of 0.5 m/s for a distance of 400 mm and 200 mm for respectively axis Z and axis X, a dwell time of 2 s and then returning at the same speed, followed by a dwell time of 2 s. Each of the acceleration and braking phases lasts 0.23 s, while the uniform motion lasts 0.57 s and 0.17 s for respectively axis Z and axis X. The two ball screws: Z with a diameter of 36 mm and X with a diameter of 32 mm were pretensioned by respectively 50 μm and 30 μm , which resulted in the simultaneous additional axial loading of bearing sets A and B of both the ball screws and in deformations of the supports and the bed/body. External nut load F_a during the work cycle, which together with the nut preload determined the instantaneous value of power losses in the screw-nut unit, was evaluated.

The instantaneous value of this load is determined by the sum of the forces acting on the nut at a given work cycle instant:

$$F_a = m \cdot g \cdot \sin\alpha \pm \mu \cdot m \cdot g \cdot \cos\alpha + F_c \quad [\text{N}] \quad (1)$$

where: m – the total mass of the assemblies shifted, g – the acceleration of gravity, α – the angle of inclination of the drive axis, μ – the coefficient of friction on the slideways, a – acceleration/ deceleration in feed motion, F_c – a component of the cutting force along the drive axis.

In the considered case, the cutting forces were not taken into account. Depending on the work cycle phase, the angle of inclination of the ball screw and the direction of movement, there can occur different combinations of force F_a components. For the constant motion velocity phase, for example, this will be only the sum of the friction forces on the slideways and the gravitational forces (if $\alpha \neq 0$). The maximum value of external ball screw nut load F_{amax} , allowable for the considered turning design, was used to select nut preload F_p (2) and the latter was used to calculate the moment of friction in the screw-nut joint T_d (3) from the formulas contained in the NSK Catalogue [12]:

$$F_p = \frac{F_{amax}}{2.8} \quad [\text{N}] \quad (2)$$

$$T_d = \frac{K \cdot F_p \cdot L}{2000 \cdot \Pi} \quad [\text{Nm}] \quad (3)$$

where: K – a preload torque coefficient, L – the lead [mm].

The loading of the nut preloaded with external force F_a results in the additional loading of half of the balls (force F_A) and simultaneously in the partial unloading of the other balls (force F_B) (Fig. 3). In the case of the uniform motion phase, this has little effect on the moment of friction in the nut since the additional loading of one part of the nut is almost counterbalanced by the unloading of its other part. However, this can be important during the starting and braking phases when due to the strong dynamic forces some of the balls can be completely unloaded.

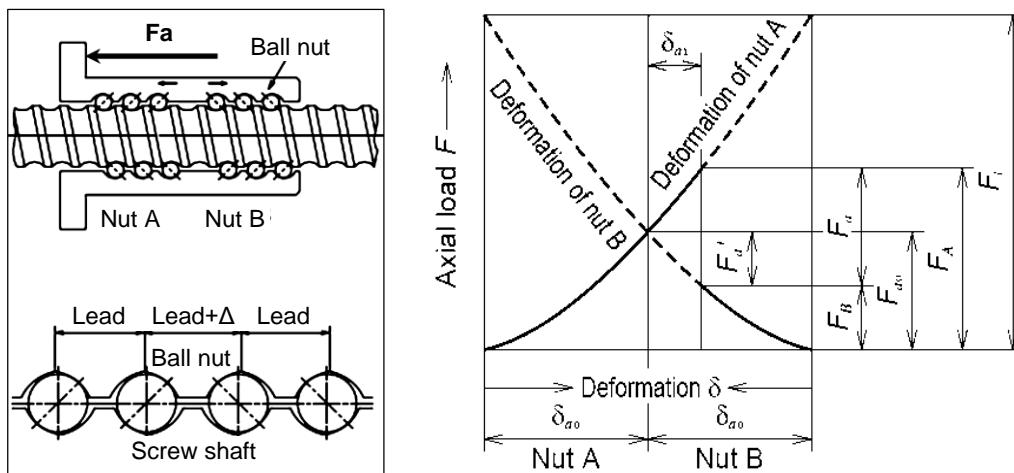

Fig. 3. Stiffness of ball screw-nut assembly [12]

The stiffness characteristics shown in Fig. 3 were taken into account in the modelling of the moment of friction in the nuts of the considered drives of the X and Z axes in order to increase the accuracy of friction moment evaluation and to regain control over the total unloading of some of the balls in the rolling nut.

By substituting the instantaneous values of external force $F_a(t) = F_A(t) + F_B(t)$ obtained from formula (3) for F_{amax} in formula (2) one gets the instantaneous values of the friction torque in the nut, produced by external force F_a acting on the preloaded nut. The friction

torque is the sum of the friction torque in loaded zone $T_A(t)$ and the friction torque in unloaded $T_B(t)$ zone, generating instantaneous power losses $P(t)$.

The heating up and thermal deformations of the ball screw are determined by the friction moment caused jointly by the nut's preload F_p and its external load F_a , generating instantaneous power losses $P(t)$.

$$P(t) = \frac{(T_A(t)+T_B(t))}{9.55} \cdot n \text{ [W]} \quad (4)$$

where: $T_A(t)$ – the instantaneous value of the friction torque in the loaded zone generated by force F_A , $T_B(t)$ – the instantaneous value of the friction torque in the unloaded zone generated by force F_B , n – the instantaneous rotational speed.

The nut power losses along axes Z and X determined in the above way are shown in Fig. 4. The different shapes of the power loss graph for the two controllable axes are due to the different loads occurring during the to-and-back motion. In the case of axis X , the inclination of the slideways and the resulting large moment of inertia at acceleration and small at deceleration are the contributing factors. For the travel up the losses are clearly larger than for the travel down towards the spindle.

Convective heat exchange coefficients, defined by the analytic formulas available in the literature, e.g. Buchman and Jungnickel [13], were applied to the machine tool (for both its movable and non-movable components) including the ball screw unit. The heat exchange between joined components was modelled through contact thermal resistance. The heat exchange on the other surfaces or between the non-contacting elements was modelled using the cavity radiation model or the radiation to ambient medium model.

The predicted power losses in the nut-ball screw assembly and in the bearing sets were used to simulate the variation in temperature in the Z axis screw-nut joint during the assumed feed drive work cycle (Fig. 5). In the over 3 second cycle (3.03 s), presented in the upper part of the Figure, the work lasted 1.03 s and the break 2 s, during which the screw temperature was decreasing. This is clearly visible in the inset in the bottom right corner of the Fig. 5 and confirms the need to include in the model such phenomena as drive run up, braking and standstill.

The temperature measured on the nut enclosure exceeds the values calculated using the FE model already after 100 s of drive operation, with the differences amounting to 1.5°C. This can be ascribed to the fact that, besides the heat generated in the screw-nut joint, also the air collecting in the only partially open spaces (very difficult to model in such structurally complex objects as the machine tool equipped with various partitions and housings) is a contributing factor.

As mentioned earlier, the increase in nut temperature during to-and-fro motion depends to a considerable extent on the duration of the breaks between the cycles.

In the example shown in Fig. 5, when the break duration is increased from 2 s to 20 s, the increase in nut temperature after 1200 s does not exceed 1°C, while the increment in screw length near the rear bearing support decreases from 15 µm for the 2 s break to about 1 µm for the 20 s break. A comparison of the computed and measured temperatures for the initial work period, in which the impact of the environment and the cover is negligible, shows good agreement. This means that the model is correct.

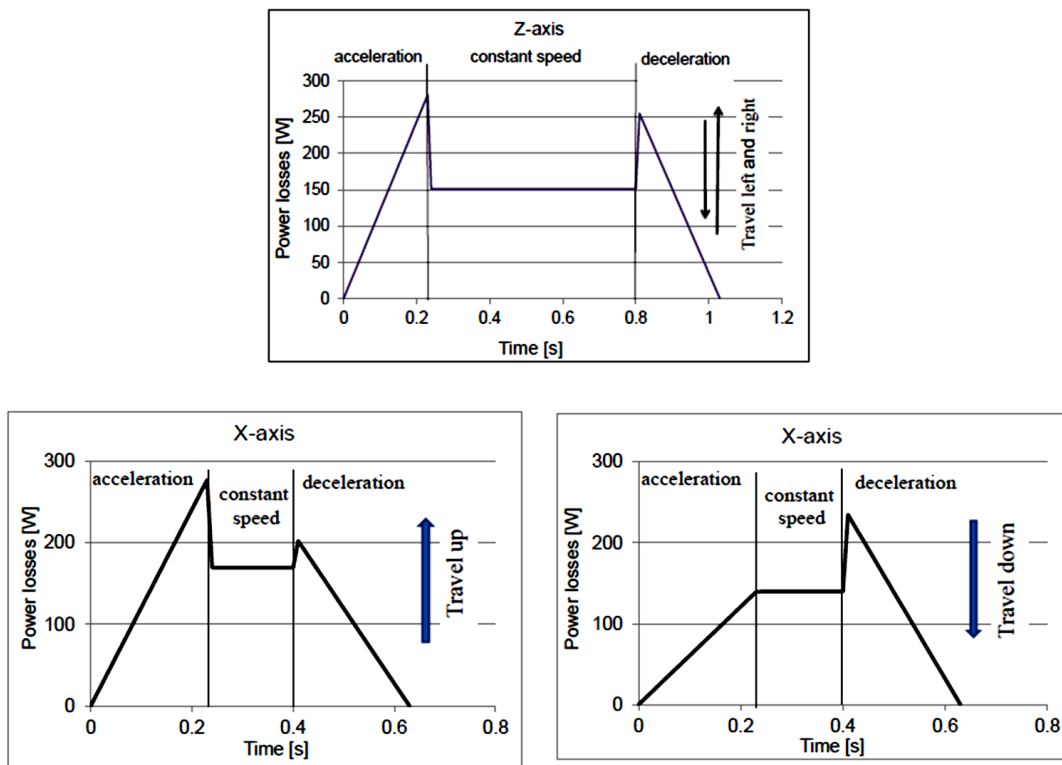

Fig. 4. Nut/screw power losses in Z and X axis

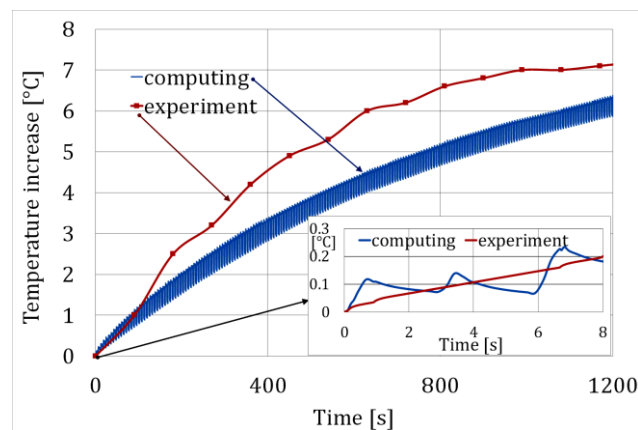

Fig. 5. Comparison of computed and measured ball screw nut temperatures during operation of Z axis drive

3.2. BALL SCREW LOAD

The screw preload R ($50 \mu\text{m}$ along the Z axis) and dynamic load, taking into account the moment of inertia of the carriage being shifted and the friction forces determined by the mass of the carriage and the variable coefficient of friction on the slideways coated with plastic (TURCITE), have a bearing on the instantaneous tension of the ball screw during the performance of work cycles. Also changes in the location of the ball screw supports on the bed accompanied by changes in the temperature of the bed and the decay of the preload in the ball screw affect this tension.

Figure 6 shows the forces (taken into account in the calculations) acting on the ball screw during the operation of the Z axis drive. These are the friction forces on the slideways (F_{1-2}) and the inertial forces of the shifted masses (I). The cutting forces, which will also be transmitted by the ball screw to the machine tool bodies, were not taken into account. Depending on the direction of motion ($\pm V$), the nut will exert tractive force $F_{pull} = I + F_{1-2}$ on the ball screw, directed towards the front or rear bearing support. The bearings in these supports differ markedly in their axial stiffness, as shown by the sketches in the upper part of Fig. 6. The right support, where the tightening of the ball screw takes place, has axial stiffness in only one direction. The heat generated in the nut and in the bearings of the two supports heats up the ball screw causing its elongations, which are partly compensated by a reduction in ball screw preload R . For the previously assumed work cycle of axis Z the preload decayed completely after about 22 minutes of drive operation (Fig. 7a).

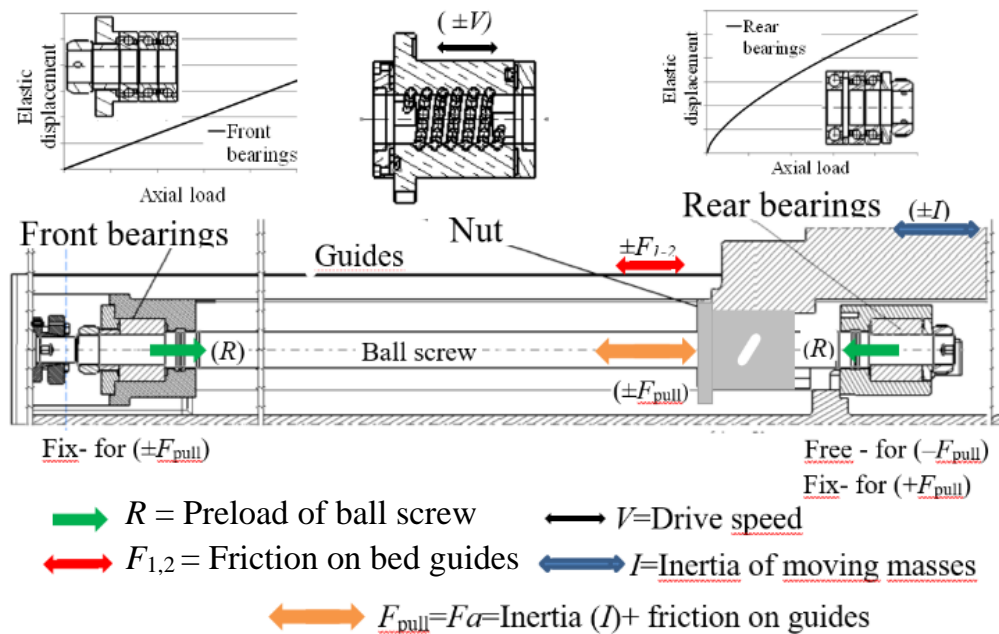

Fig. 6. Forces acting on ball screw during axis Z drive operation

If the nut finds itself in, e.g., point 8, the positioning error will amount to about 20 μm , but without the compensation it would reach nearly 60 μm (Fig. 7a). The benefits from the use of ball screw preload are commensurately smaller for the ball screw points located closer to the front bearings, e.g. points 4 and 2. Until the preload decays completely, elastic strains generated by dynamically changing tractive force F_{pull} get superimposed on the thermal elongations of the ball screw (Fig. 7b). Beginning with the time of 50 min (Fig. 7c), the temperature and ball screw point displacement plots accurately reflect the work cycle of the drive, i.e. motion forward for 1.03 s with a dwell time of 2 s and backward motion for 1.03 s with a dwell time of 2 s.

The temperature and displacement traces shown in Fig. 7b were disturbed by feedbacks between the generated heat, the compliance of the supports and the bearings and the changing ball screw preload.

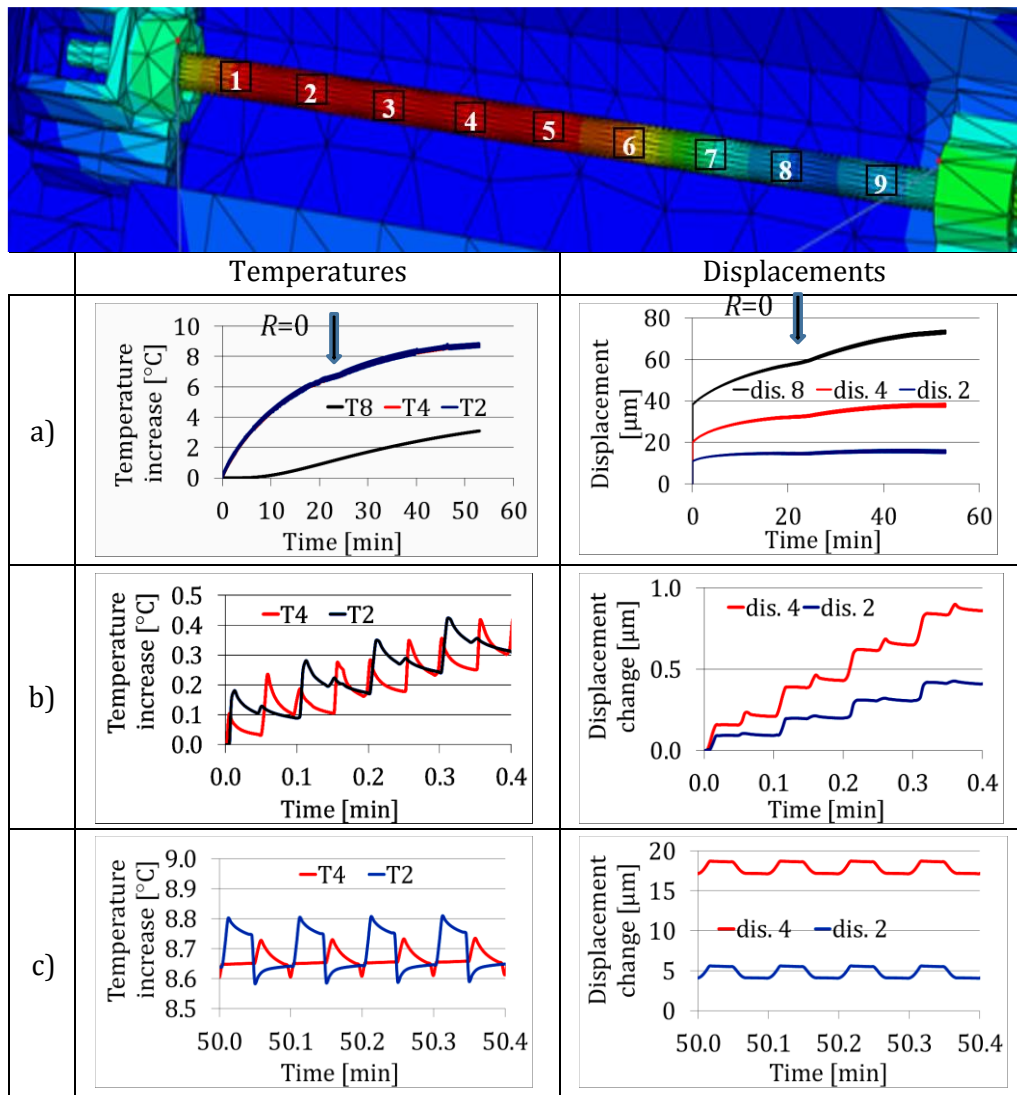

Fig. 7. Heating up and axial displacement of ball screw during Z axis drive operation

3.3. SLIDEWAYS

Considering the importance of the moving heat source, i.e. the connection of the carriage with the slideways (e.g. the top and bottom bed slideways along axis Z), one should take into account the oblique location of the slideways, resulting in different pressures, which affects the friction forces, the temperatures and the displacements. Also important is the degree of simplification adopted in the modelling of heat generation in slideway systems.

Figure 8 shows simulated temperature distributions on the bed slideways along direction Z, using the precise model (the upper curve) and the simplified model (the bottom curve). As one can see, quite different temperature distributions along the considered slideways were obtained.

The simplified model took into account only average pressures on the surface of the slideways, whereas the precise model took into consideration all the static and dynamic loads acting on the top and side surfaces of the slideways, as well as the clearances in the joints.

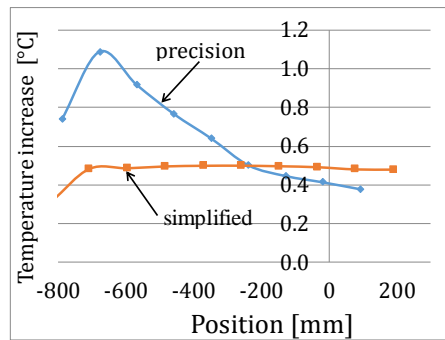

Fig. 8. Upper guide temperature along Z axis, simulated using respectively precise and simplified model

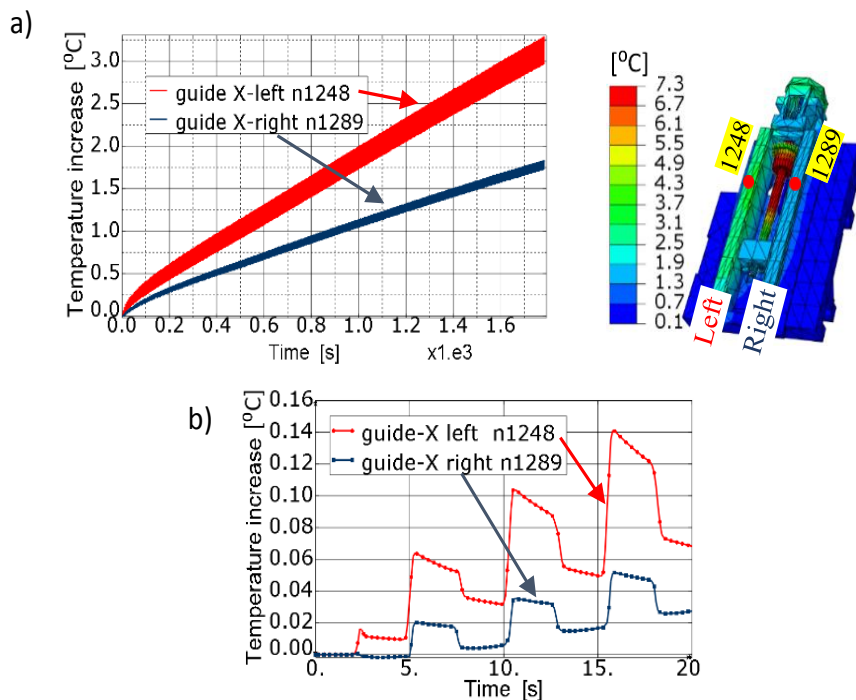

Fig. 9. Guide temperature of drive X: a) variation in temperature of left and right guide, b) detailed characteristic of guide-X initial transient temperature from 0 to 20 s of operating time

The considerably higher temperatures of the bottom guide are mainly due to the function which it performs in the machine tool – this guide carries all the gravitational forces of the assemblies being shifted, i.e. the longitudinal slides and the carriages together with the X and Y axes drives. The presented simulation results convincingly argue for precise modelling since the adoption of too drastic model simplifications can lead to erroneous conclusions.

Figure 9 shows how temperature changes in selected points on respectively the left and right guide during successive feed cycles. After 30 minutes (1800 s) the temperature difference between the two guides amounted to about 1.5°C. The variation in temperature on the guides during the work cycles is similar to the variation in the temperature of the nut, despite the different heat capacity of the guides and the ball screw unit.

This is shown in Fig. 9b where in the short time interval of 20 s one can see (besides the different heating up of the guides) the drive work cycle consisting of a carriage run up, uniform motion, braking and a break. Figure 10 shows the displacements of the bed guides

along directions *X* and *Y* caused by the drive operation along the *X*-axis. Since in precision turning the resulting errors directly affect machining accuracy, they deserve attention.

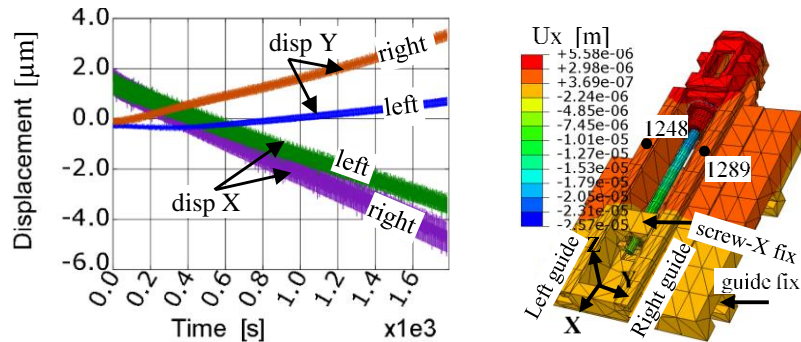

Fig. 10. Transient displacements of left and right guide-*X* along direction *X* and *Y*

3.4. AMBIENT TEMPERATURE

The accurate modelling of the ball screw unit should take into account the variation in ambient temperature due to the different inertia of the heating up/cooling of the turning centre assemblies with the rise/fall of ambient temperature, as illustrated by the diagram shown in Fig. 11.

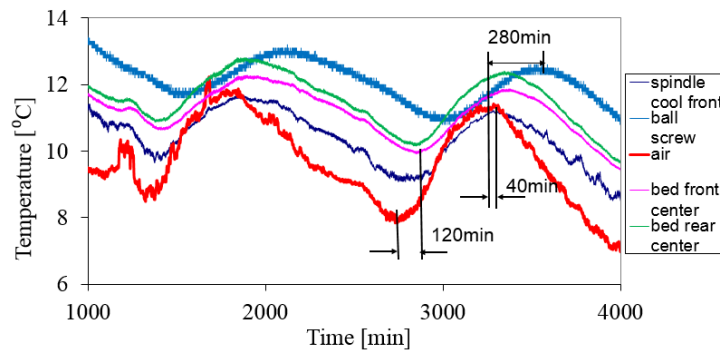

Fig. 11. Effect of long-term variation in ambient temperature on temperature of turning assemblies for spindle running

In the considered case, the spindle tip reacts most quickly (after 40 min) to changes in ambient temperature, followed by the points located on the outer surface of the bed (after 120 min) and lastly, the ball screws (after 280 min). The repeatable one-minute spindle work cycle with a short break of 10 s, used in the measurements can be treated as continuous operation for over two days during which the only variable factor was the ambient temperature.

3.5. POSITIONING

Not only the nut positioning error, but also the geometric deformations of the shifted machine tool bodies, caused by heat and the forces of inertia, contribute to the total toolhead

positioning error. This is particularly visible for the X axis deviating from the horizontal by 30°, whereby the forces loading the drive significantly differ for the two directions (upwards and downwards) of motion.

The results presented in Fig. 12 are for the preloaded ball screw (23 μm in the place where the nut is located) when the carriage is in the upper position (n335). To-and-fro motions were performed for a travel distance of 200 mm in a repeated cycle: 0.63 s of work (motion downwards) and a 2 s pause followed by motion upwards (0.63 s) and a 2 s pause. The top diagram (Fig. 12b) shows the displacements of toolhead point n792 relative to the nut and the displacements of ball screw point n335. The visible changes in the displacements are due to the dynamic forces connected with: the performance of the upward and downward motion, the thermal elongations of the ball screw, the decreasing ball screw preload and the thermal displacements of the whole drive, taking into account the heat generated in the bearings and on the slideways.

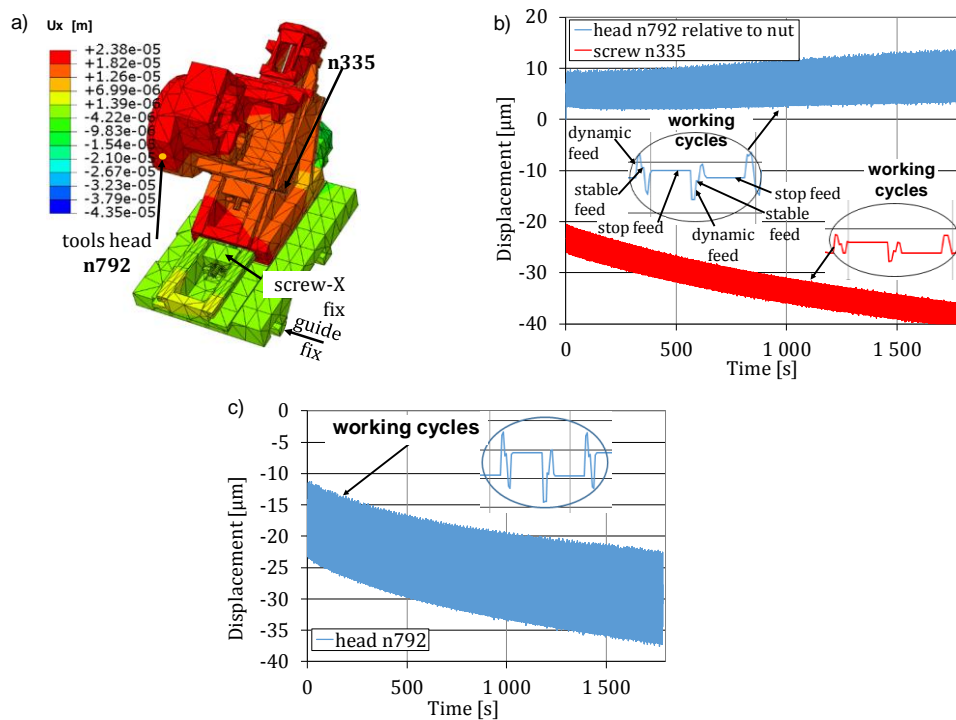

Fig. 12. Axial displacement of ball screw and toolhead during operation of X axis drive: a) geometrical structure of X axis drive, b) components of toolhead positioning error, c) sum of toolhead positioning error components in upper position

The toolhead positioning error is the sum of the displacements of a selected ball screw point and the head relative to the nut (Fig. 12c). The dominant component of this error are the thermal and elastic elongations of the ball screw, which are only partially compensated by the deformations of the head body, the elastic deformations of the lower bearing support and the decrease in the force tightening the ball screw.

The toolhead positioning error along the X axis increases with the distance of the nut from the lower bearing support and it is the largest in the upper position of the toolhead, i.e. when the nut is in the vicinity of point n335 (Fig. 13).

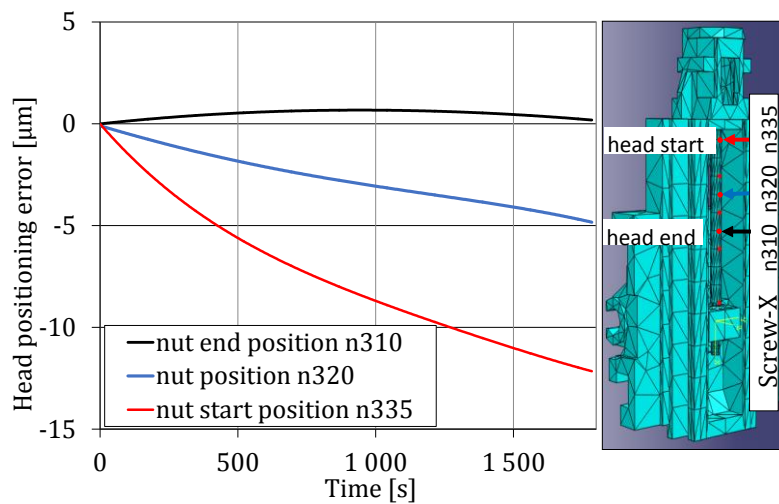

Fig. 13. Head positioning errors for X axis for three nut positions

The diagram of the head positioning error versus time for the given work cycle, work time and nut position on the ball screw can be used to formulate an error function essential for effective error compensation in real time.

4. CONCLUSION

From the presented results of the research on the modelling of the thermal behaviour of the assemblies of the turning centre ball screw unit for the assumed work cycle one can draw the following conclusions:

1. Elaborated holistic thermal model of feed drive unit shows a high sensitivity of temperature changes on dynamics of the friction nodes load.
2. The numerical modelling of the thermal errors in the positioning of machine tool drives must be based on a precise model of the moving heat sources. The model should integrate the thermal and force loads and their dynamics in the work cycles.
3. The thermal error of positioning the nut/carriage TCP (Tool Centre Point) largely depends on the ball screw preload changing along the ball screw.
4. The thermal model of the ball screw unit has been verified through a comparison of the simulated and measured dynamic changes in the temperature of the screw shaft connection with the nut for working cycles in the early stage of operation.
5. In order to precisely determine positioning errors one should take into account the effect of the deformation of the slideways by dynamic loads.
6. The resultant displacements of the (carriage) TCP during drive running, determined through precise modelling and numerical simulations, can be considered as axial errors to be compensated.
7. The estimated dynamic changes of ball screw errors are the basis for real-time compensation.

ACKNOWLEDGEMENTS

The authors express their thanks to Doosan Infracore Co. for making it possible to test the model and for financially supporting this research.

REFERENCES

- [1] JEDRZEJEWSKI J., KWASNY W., 2017, *Development of machine tools design and operational properties*, Int. J. Adv. Manuf. Technol. 93, 1051–1068.
- [2] ALTINTAS Y., VERL A., BRECHER C., et al., 2011, *Machine tool feed drives*, CIRP Annals – Manufacturing Technology 60 (2), 779–796.
- [3] JEDRZEJEWSKI J., KOWAL Z., KWASNY W., WINIARSKI Z., 2018, *Effectiveness of modelling the thermal behaviour of the ball screw unit with moving heat sources taken into account*, Conference on Thermal Issues in Machine Tools, TU Dresden, Verlag Wissenschaftliche Scripten, 179–192.
- [4] VERL A., FREY S., 2010, *Correlation between feed velocity and preloading in ball screw drives*, CIRP Annals – Manufacturing Technology, 59/1, 429–432.
- [5] WINIARSKI Z., KOWAL Z., JEDRZEJEWSKI J., KWASNY W., 2017, *Precise modelling of machine tool drives with ball screw thermal behavior*, Journal of Machine Engineering, 17/1, 31–45.
- [6] WU C.H., KUNG Y.T., 2003, *Thermal analysis for the feed drive system of a CNC machine centre*, International Journal of Machine Tools & Manufacture, 43, 1521–1528.
- [7] HEISEL U., KOSCSAK G., STEHLE T., 2006, *Thermography-based investigation into thermally induced positioning errors of feed drives by example of a ball screw*, CIRP Annals – Manufacturing Technology, 55/1, 423–426.
- [8] KIM S.K., et al., 1997, *Real-time estimation of temperature distribution in a ball-screw system*, International Journal of Machine Tools and Manufacture, 37, 451–464.
- [9] GLEICH S., 2007, *Approach for simulating ball bearing screws in thermal finite element simulation*, Journal of Machine Engineering, 7/1, 101–107.
- [10] GROCHOWSKI M., JEDRZEJEWSKI J., 2006, *Modelling headstock motion influence on machine tool thermal behavior*, Journal of Machine Engineering, 6/2, 124–133.
- [11] JEDRZEJEWSKI J., MACIOLKA P., 2017, *Evaluation of different approaches to 3D numerical model development of the contact zone between elementary asperities and flat surface*, Journal of Machine Engineering, 17/4, 40–53.
- [12] BUCHMAN K., JUNGnickel G., 1978, *Die Wärmeübertragung an Be-und Verarbeitungs-maschinen*, PWR Wrocław, ITMiA, 20, 279, (in Polish).
- [13] NSK, 2011, *Precision machine components*, Catalogue, No. E9008a 2011 Z-9, NSK Motion & Control.