

SEBASTIAN WERLE¹

SEWAGE SLUDGE GASIFICATION: THEORETICAL AND EXPERIMENTAL INVESTIGATION

Results of experimental and theoretical investigations of a sewage sludge gasification process have been presented. They show that higher oxygen content in sewage sludge causes a reduction in the reaction temperature. As expected, increasing the air flow rate caused a decrease in the heating value of the produced gas. A higher amount of oxidizer increases the amounts of noncombustible species and volumetric fraction of nitrogen, thus reducing the heating value of the obtained gas. Higher water content in the sewage sludge affects the gasification gas composition. As a result, combustible components are in the minority in the syngas.

1. INTRODUCTION

Sewage sludge originating from the treatment process of waste water is the residue generated during primary (physical and/or chemical), secondary (biological) and tertiary (additional to secondary, often nutrient removal) treatment [1–3]. Removal of sludges from wastewater treatment plants (WWTP) represents a serious worldwide environmental problem. Until recently, raw sludge was considered a valueless material that should be discarded, and then it was disposed of in landfills and/or thrown into the ocean. But the huge amounts of sludges produced (Table 1) [4] make all these options environmentally unacceptable.

High output of sewage sludge, which was increasing during recent years, and the limitations of the existing means of disposing sewage sludge highlight the need to find alternative routes to manage this organic material. The 6th Environment Action Programme 2002–2012 of the European Commission has been described as a major factor in reducing sewage sludge disposal by 50% from 2000 by 2050. Moreover, European legislation prohibits the deposition of sewage sludge with the indicated parameters (Table 2) into landfill or water.

¹Institute of Thermal Technology, Silesian University of Technology, ul. Konarskiego 22, 44-100 Gliwice, Poland; e-mail: Sebastian.werle@polsl.pl

Table 1

Per capita sludge production
in various countries

Country	Sludge production [g/(person-day)]
China	16
Slovenia	20
Brazil	33
Italy	38
Poland	42
Hungary	48
Austria	55
Portugal	60
Turkey	60
Canada	76
Finland	94
Medium value	49

Biomass and residues like sewage sludge are the only renewable energy sources that can provide C and H, thus it is interesting to process them by means of treatments that enable one to obtain chemically valuable products like fuels. The latest trends in the field of sludge management (i.e., combustion, pyrolysis, gasification and co-combustion) generated significant scientific interest [5]. Gasification is the process of converting a solid fuel into a gas by treating the solid fuel in a generator with oxygen, air, and steam or by other gasification methods [6].

Table 2

Criteria for the storage of sewage sludge
in a non-hazardous waste landfill

Parameter	Value limit
Overall organic carbon (OOC), % d.b.	5.0
Loss at calcinations (LOC), % d.b.	8.0
The higher heating value, MJ/kg d.b.	Maximum 6.0

The most important reactions that take place in the reduction zone of a gasifier between various gaseous and solid reactants are given below. A minus sign indicates that heat is generated in the reaction, a positive sign that the reaction requires heat.

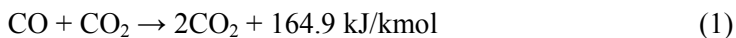

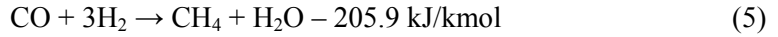
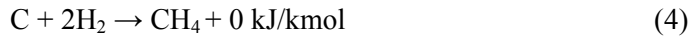
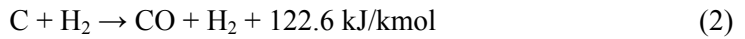

Gasification of sewage sludge leads to a high-quality flammable gas that can be used for the generation of electricity or to support such processes as the drying of sewage sludge [7]. Gasification is one way of using sewage sludge and is an attractive alternative to other treatment methods [8]. Despite the fact that sewage sludge contains phosphorus, nitrogen and sulfur (in low concentrations) and trace elements, gasification of these components offers several advantages over a traditional combustion process. Gasification takes place in an environment with low levels of oxidizers (to prevent the formation of dioxins) and large quantities of sulfur and nitrogen oxides [9]. As mentioned above, sulfur is present in sewage sludge at low amounts; it is mainly converted to hydrogen sulfide (H_2S) during gasification [10], whereas nitrogen is transformed into ammonia [9]. It is worth noting that phosphorus in sewage sludge is partitioned into solid (not gaseous) residues [11] and that the volume of syngas produced from sewage sludge is low because gasification requires stoichiometric amounts of oxygen. For all of these reasons, gasification requires smaller and less expensive gas-cleaning facilities [12].

Any thermal method for the disposal of sewage sludge is usually preceded by partial or total drying. It is clear that sewage sludge should be concentrated (naturally on a drying bed or in lagoons, or mechanically using presses or centrifuges), stabilized (biologically or chemically), and dehydrated on filters. The types of procedures performed on the sewage sludge primarily depend on the technological scheme of the treatment plant and secondly on the expected mode of sewage-sludge utilization. These processes may be an integral part of the waste water treatment plant or can be elements of the proposed installation for the thermal treatment of sewage sludge. To determine the usefulness of sewage sludge for thermal transformation, it is necessary to know its basic physical and chemical characteristics. The elemental composition of sewage sludge and contents of trace elements and inorganic compounds depend on many factors but it may be largely dependent on the country or region of origin [13].

The paper presents the results of experimental and theoretical investigation of a sewage sludge gasification process. An installation with an fixed bed gasifier was used. Analysis of the influence of composition, volatile matter content, and water content of the sewage sludge samples on the composition of the gas produced from the autothermal gasification process was conducted. Experiment results were compared with those of equilibrium Gaseq software calculations.

2. EXPERIMENTAL

A commercial predried sludge (granulated sewage sludge 1 and 2), whose properties are reported in Table 3, was investigated.

Table 3

Composition of the fuels tested

Fuel	Granulated sewage sludge 1 (ss1)	Granulated sewage sludge 2 (ss2)
Proximate analysis, % (as received)		
Moisture	9.00	25.00
Volatile matter	52.5	44.5
Ash	32.35	31.50
Ultimate analysis, % (dry basis)		
C (dry)	31.83	33.78
H (dry)	5.30	4.92
O (dry)	23.76	22.89
N (dry)	4.50	4.25
S (dry)	0.35	0.85
P (dry)	1.79	1.81
LHV, MJ/kg (on dry basis)	13.43	10.92

Fuel particles were produced by drying and granulating the raw sludge. The fuel particles were sieved in the 4.75–6.50 mm size range. For the purpose of experimental investigations, a laboratory system was designed and built. A schematic diagram of the system is presented in Fig. 1.

The main part of the installation is a stainless fixed bed gasifier (G), of 150 mm internal diameter and the total height of 250 mm. The maximum capacity is 5 kg of granular sewage sludge (SS). For this study, granular sewage sludge was fed into the reactor from the top, while air was supplied by a blower (B) from the bottom. The sewage sludge feedstock moved in a countercurrent direction to the flow gas and passed through the drying, pyrolysis, reduction and combustion zones. The moisture was evaporated in the drying zone. In the pyrolysis zone, the sewage sludge was thermally decomposed to volatiles and solid char. In the reduction zone, carbon was converted, and CO and H₂ were produced as the main components of the syngas. In the combustion zone, the remaining char was combusted, providing heat for endothermic reactions in the upper zones. The temperature of the gasifier interior was measured by six N-type thermocouples located along the vertical axis of the gasifier at various heights. Additionally, the temperature of the syngas at the outlet of the gasifier was measured. The air flow rate supplied into the gasifier was measured by a flow meter. Syngas was transported from the gasifier by the pipe (P) as shown in Fig. 1. At the outlet of the installation, there was a syngas sampling point where the syngas sample

was collected and then supplied to CO and H₂ analyzers. The syngas was cleaned in a cyclone (C), scrubber (S) and drop separator (DS). Molar fractions of the main combustible species were measured online at the experimental stand and, for one specified experimental sample, the composition of syngas was investigated by the chromatographic analysis.

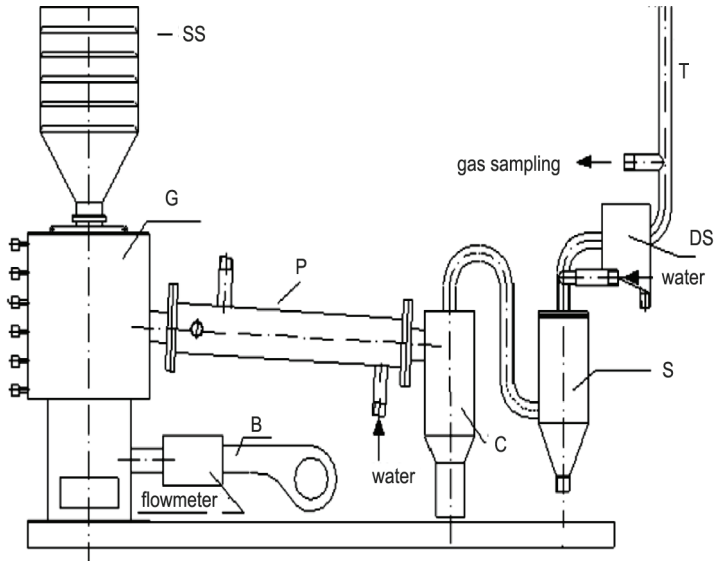

Fig. 1. Schematic diagram of the experimental system

3. EQUILIBRIUM CALCULATION

In order to compare the experimental results, equilibrium calculation of sewage sludge gasification process has been done. It was assumed that the gasification process was carried out in a downdraft fixed bed gasifier. In that way, the amount of tar at the end of the process is very low because the most of it is combusted in the oxidation zone. For that reason, tars are ignored in the model, and the only species created during the process are CO, CO₂, H₂O, H₂, CH₄, N₂ and O₂. The gasification factor used in the process is atmospheric air. Two important assumptions have been made during the calculations. Firstly, we assumed that the residence time of the reactants in the reactor is long enough to achieve an equilibrium, which has also been confirmed by the authors [14] and secondly, we assumed that all of the carbon in the sewage sludge is gasified, and the formation of charcoal can be neglected. The calculation of the composition of the gasification gas was done for two types of sewage sludge analyzed also in experimental part of the work. Gaseq software was used to calculations [15–18].

4. RESULTS AND DISCUSSION

4.1. INFLUENCE OF SEWAGE SLUDGE ON THE COMPOSITION OF SYNGAS

Figure 2 presents the results of gasification of the most combustible species for two different granular sewage sludge samples (ss1 and ss2) in function of the air excess ratio λ .

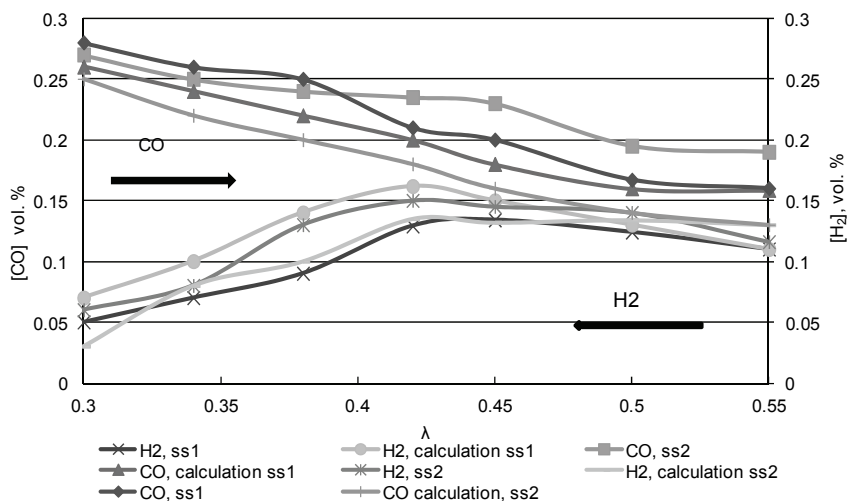

Fig. 2. Influence of sewage sludge on the composition of syngas

Results of the calculations of the syngas composition at equilibrium are also presented. The molar fraction of carbon dioxide increased with increases in the air excess ratio. In the case of ss1, the molar fraction of CO was within the range of 16–28%, while in the case of ss2, the molar fraction of CO was in the range of 19–27%. All of the parameters of the gasification process were the same in both cases and the difference in the molar fractions of CO was likely due to the reactivity of the fuel. The percentage of hydrogen in the obtained gas was variable, but the changes were not very drastic (z_{H_2} ranged from 0.07 to 0.12). The volumetric fraction of hydrogen peaked when the air excess ratio λ was 0.42. The molar fraction of hydrogen was higher for ss2, which was characterized by increased moisture in the sample. It can be seen in the figure that the results of equilibrium calculations are in good agreement with the experimental results.

4.2. INFLUENCE OF AIR EXCESS RATIO ON THE CALORIC VALUE OF THE OBTAINED GAS

Figure 3 presents the dependence of the heating (caloric) value of the obtained gas on the air excess ratio for the sewage sludge samples. Results of the syngas composi-

tion equilibrium calculations are also presented. As expected, an increase in the air excess ratio caused a decrease in the heating value. A greater amount of oxidizer increases the amounts of noncombustible species and the volumetric fraction of nitrogen, thus decreasing the heating value of the obtained gas.

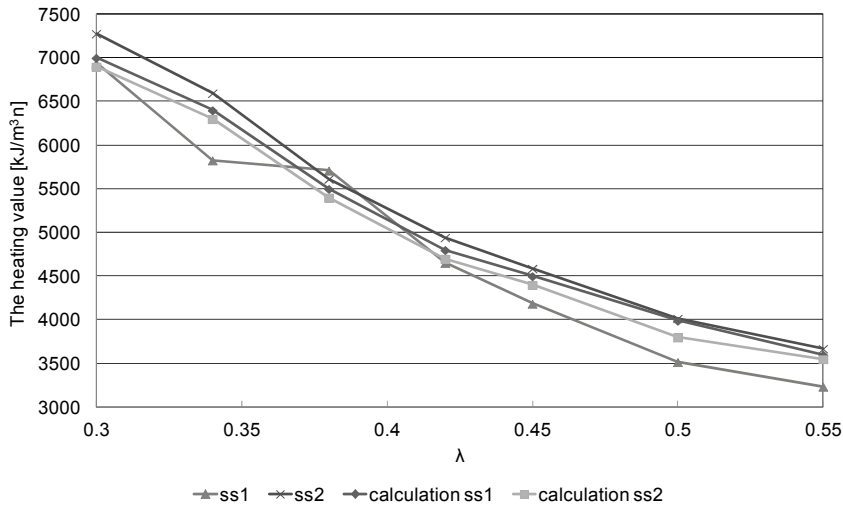

Fig. 3. Influence of air excess ratio on the caloric value of the obtained gas

5. CONCLUSIONS

In the study, gasification of air sewage sludge was investigated in a small scale gasification system under specified experimental conditions. An analysis of the influence of sewage sludge composition, volatile matter content, and water content on the composition of the gas obtained in the autothermal gasification process was conducted. The results, presented in function of the amount of gasification agent, show that higher oxygen content in sewage sludge causes a reduction in the reaction temperature. Paradoxically, this effect causes an increase in the quantity of combustible components in the gas. As expected, increasing the air excess ratio caused a decrease in the heating value of the produced gas. A higher amount of oxidizer increases the amounts of noncombustible species and volumetric fraction of nitrogen, thus reducing the heating value of the obtained gas. Results of calculation of the equilibrium composition of the gasification gas shows good agreement with the experimental results.

ACKNOWLEDGEMENTS

The paper has been prepared within the framework of the Ministry of Science and Higher Education Iuventus Plus Program Project No. 0593/IP2/2011/71

REFERENCES

- [1] WERLE S., *Modelling of the reburning process using sewage sludge-derived syngas*, Waste Manage., 2012, 32 (4), 753.
- [2] WERLE S., *Estimation of reburning potential of syngas from sewage sludge gasification process*, Chem. Process Eng., 2011, 32 (4), 411.
- [3] WERLE S., *Possibility of NO_x emission reduction from combustion process using sewage sludge gasification gas as an additional fuel*, Arch. Environ. Prot., 2012, 38 (3), 81.
- [4] CAO Y., PAWŁOWSKI A., *Sewage sludge-to-energy approaches based on anaerobic digestion and pyrolysis: Brief overview and energy efficiency assessment*, Renew. Sust. Energ. Rev., 2012, 16 (3), 1657.
- [5] WERLE S., *Analysis of the possibility of the sewage sludge thermal treatment*, Ecol. Chem. Eng., 2012, 19 (1–2), 137.
- [6] NADZIAKIEWICZ J., WAĆLAWIAK K., STELMACH S., *Thermal processes for waste treatment*, The Silesian University of Technology, Gliwice, 2007 (in Polish).
- [7] FILIPIAK J., PRZYBYŁA C., *Solar energy application for sewage sludge drying process*, Rocznik Ochrona Środowiska, 2011, 13, 1783.
- [8] WERLE S., *A reburning process using sewage sludge-derived syngas*, Chem. Pap., 2012, 66 (2), 99.
- [9] BUCKLEY J.C., SCHWARZ P.M., *Renewable energy from gasification of manure: an innovative technology in search of fertile policy*, Environ. Model. Assess., 2003, 84 (1–2), 111.
- [10] MENG X., DE JONG W., PAL R., VERKOOIJEN A.H.M., *In bed and downstream hot gas desulphurization during solid fuel gasification: A review*, Fuel Process. Technol., 2010, (91) 9, 964.
- [11] ZHU W., XU Z.R., LI L., HE C., *The behavior of phosphorus in sub- and super-critical water gasification of sewage sludge*, Chem. Eng. J., 2011, 171 (1), 190.
- [12] MORRIS M., WALDHEIM L., *Energy recovery from solid waste fuels using advanced gasification technology*, Waste Manage., 1998, 18 (6–8), 557.
- [13] WERLE S., WILK R.K., *A review of methods for the thermal utilization of sewage sludge: The Polish perspective*, Renew. Energ., 2010, 35, 1914.
- [14] ZAINAL Z.A., ALI R., LEAN C.H., SEETHARAMU K.N., *Prediction of performance of a downdraft gasifier using equilibrium modeling for different biomass materials*, Energ. Convers. Manage., 2001, 42, 1499.
- [15] WERLE S., WILK R.K., *Experimental investigation of the sewage sludge gasification process in the fixed bed gasifier*, Chem. Eng. Trans., 2012, 29, 715.
- [16] WERLE S., WILK R.K., *Gaseous fuel production using sewage sludge gasification process*, Rynek Energii, 2012, 101 (4), 94 (in Polish).
- [17] WERLE S., WILK R.K., *A self-ignition of methane in high temperature air*, Chem. Process Eng., 2007, 28, 399.
- [18] WERLE S., WILK R.K., *Analysis of use a sewage sludge derived syngas in the gas industry*, Rynek Energii, 2011, 5, 23 (in Polish).