

Two-step treatment of harmful industrial wastewater: an analysis of microbial reactor with integrated membrane retention for benzene and toluene removal

Anna Trusek-Holownia, Andrzej Noworyta

Wroclaw University of Technology, Group of Bioprocess and Biomedical Engineering, Faculty of Chemistry, Wybrzeze Wyspianskiego, 50-370 Wroclaw, Poland

*Corresponding author: e-mail: anna.trusek-holownia@pwr.edu.pl

Standards for highly toxic and carcinogenic pollutants impose strict guidelines, requiring values close to zero, regarding the degradation of such pollutants in industrial streams. In many cases, classic bioremoval processes fail. Therefore, we proposed a stream leaving the microbial membrane bioreactor (MBR) that is directed to an additional membrane separation mode (NF/RO). Under certain conditions, the integrated process not only benefits the environment but may also increase the profitability of the bioreactor operation. An appropriate model was developed and tested in which the bioremoval of benzene and toluene by *Pseudomonas fluorescens* was used as an example. This paper presents equations for selecting the operation parameters of the integrated system to achieve the expected degree of industrial wastewater purification.

Keywords: bioremoval, benzene, toluene, MBR, mathematical model, membrane separation.

INTRODUCTION

BTEX (benzene-toluene-ethylbenzene-*o,m,p*-xylene), which are highly toxic organic compounds, are commonly found in crude oil and its refined products. The average weight percentage of BTEX in petrol is 18%, and the wt% of particular compounds is presented in Figure 1¹. Due to the strong carcinogenic properties of BTEX, the methods of their disposal in the natural environment are very restrictive².

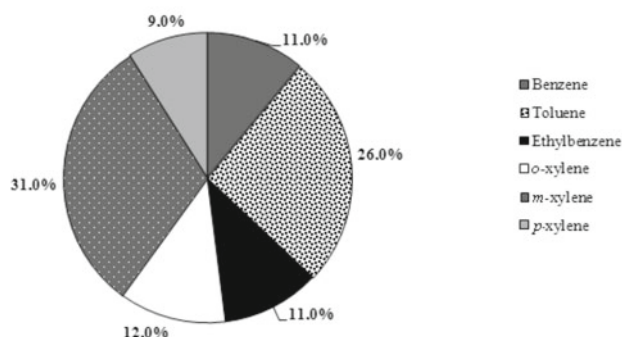

Figure 1. The average weight percentage of BTEX in petrol¹

Microbial degradation is a type of chemical reaction that utilises a catalyst, which in this case, is a group of enzymes produced by microorganisms. The process in its simplest form can be described as a first-, zero- or fractional-order reaction, depending on the limiting substrate concentration. Due to a limited range of concentrations, the kinetics of low water solubility substrates are usually first order^{3,4}. However, even at these relatively low concentrations, substrate inhibition is observed for highly toxic compounds^{5,6}. In such case, in CSTR two steady-states can occur at:

$$\tau = \frac{1}{\mu} = \frac{C_{X,1}}{Y_{X/S} \cdot r_S(C_{S,1})} = \frac{C_{X,2}}{Y_{X/S} \cdot r_S(C_{S,2})} \quad (1)$$

where:

$Y_{X/S}$ – biomass yield coefficient, $g_X g_S^{-1}$,

μ – specific growth rate, h^{-1} ,

τ – residence time, h.

Specific growth rate and biomass yield coefficient are common applied in description of microbial process. The methods for their value estimation were presented in literature^{7,8}. However, not all states in the reactor are stable⁹. The stable and most interesting working point of the bioreactor, i.e., that corresponding to the lowest substrate concentration and thus a higher biomass concentration (Fig. 2), are considered here, thus limiting the kinetics to the substrate range described by the Monod equation¹⁰.

As the conversion of xenobiotic compounds, including BTEX, is a complex process consisting of several successive reactions¹¹, the slowest step limits the overall rate of the entire process. However, the bioremoval rate is usually defined as the change in the initial substrate (pollutant) concentration and can be connected with the empirical Monod equation¹⁰ given in Equation (2).

$$r_S = \frac{dc_S}{dt} = \frac{1}{Y_{X/S}} \frac{dc_X}{dt} = \frac{1}{Y_{X/S}} \cdot c_X \cdot \mu = \frac{1}{Y_{X/S}} \cdot c_X \cdot \frac{\mu_{max} \cdot c_S}{K + c_S} \quad (2)$$

where:

K – Monod equation constant, $g dm^{-3}$,

μ_{max} – maximal specific growth rate, h^{-1} .

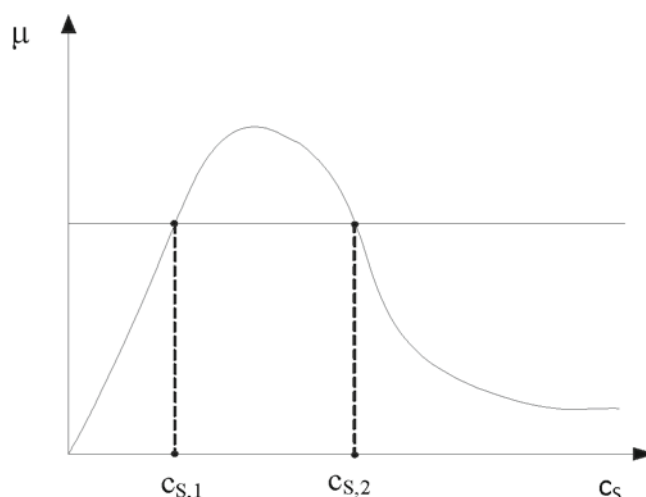

Figure 2. Steady states in the case of microbial kinetics with a substrate inhibition (one value of μ corresponds to two states i.e. two different biomass concentration and two different $c_{S,2}$)

The value of the specific growth rate (μ) for BTEX as the substrate is very low (on the order of 10^{-2} h^{-1})^{12, 13, 14}. This value can be somewhat improved using a mixture of various microbial cultures, i.e., a microbial consortium^{15, 16, 17}. The benefits of microbial consortia include complementation (production of other enzymes), strengthening of catalytic pathways (production of enzymes more resistant to inhibition and/or characterizing higher turnover rate constant), and exchange of genetic material between bacterial species through transfer of plasmids with catalytic properties they encode¹⁸.

Standards required for output values of BTEX² practically impossible to carry out processes of their bioremoval in the CSTR (Continuous Stirred Tank Reactor). Therefore, the processes described in literature¹²⁻¹⁷ involved batch cultures. At the large volumes of industrial waste water its necessitates the use of large-scale reactors.

The paper describes novel method for improving the effectiveness of bioremoval based on the integration of CSTR with two membrane modules. The advantage of the method is to operate the process continuously. Based on the elaborated model used in our work, we analysed how the application of a second module (nanofiltration or reverse osmosis modules), which facilitated pollutant separation and the return of the pollutant in the retentate stream to the bioreactor, affected the substrate conversion degree and the pollutant concentration in the outgoing streams. This integrated approach is novel.

The use of membrane processes to achieve the required standards of another compounds in a permeate stream has been previously described in the literature^{19, 20}. There are also numerous applications of integration processes run in a (bio)reactor with one membrane separation step^{21, 22, 23}, which also increases the biomass concentration in the vessel of the bioreactor^{24, 25}. However, in presented case we expect an impact of the substrate separation on the reactor working and the role of each node of membrane separation. The model results were verified based on the bioremoval process of benzene and toluene using *Pseudomonas fluorescens*.

EXPERIMENTAL

Material

The *Pseudomonas fluorescens* PCM 2123 strain was obtained from the Institute of Immunology and Experimental Therapy of the Polish Academy of Sciences in Wrocław (Poland). The microorganisms were adapted into the environment of BTEX by gradually adding them (until the concentration 0.16 g dm^{-3}) to the culture with 1 g dm^{-3} glucose (cometabolism) followed by cessation of addition of glucose. Finally, benzene and toluene was the only source of carbon and energy.

Benzene, toluene and salts (KNO_3 , KH_2PO_4 , K_2HPO_4 , NaCl , MgSO_4 , FeCl_3) were from POCH, Gliwice (Poland). All chemicals used were of analytical purity.

The microfiltration module consisted of a stainless steel membrane module with a multi-channel microfiltration ceramic membrane pipe (FiltaniumTM) – $d_{\text{pores}} = 0.14 \text{ mm}$, $A = 0.013 \text{ m}^2$.

The reverse osmosis module consisted of an AFC 80 membrane (PCI Membranes), made of a polyamide

with an effective area of 0.45 m^2 . The membrane can be applied under maximum pressure of 6.4 MPa .

Kinetic studies and $Y_{X/S}$ coefficient estimation

The bioremoval kinetics was determined in semi-continuous cultures with periodic doses of benzene or toluene. The culture medium was a broth consisting (g dm^{-3}) of: $1 - \text{KNO}_3$, $1 - \text{KH}_2\text{PO}_4$, $1 - \text{K}_2\text{HPO}_4$, $1 - \text{NaCl}$, $0.02 - \text{CaCl}_2$, $0.2 - \text{MgSO}_4$ and $0.001 - \text{FeCl}_3$ at pH 6.5. Due to the high volatility of the substrates, classical culture oxygenation was not possible. Glass flasks filled with the solution were tightly closed and shaken at 200 rpm and a temperature of 24°C . H_2O_2 was added as an oxygen source²⁶. Its concentration was selected experimentally (the range of $0.01-0.04\%$ v/v was tested). Higher concentrations of H_2O_2 than 0.02% v/v did not cause changes in the cell growth rate. Thus, the concentration of 0.02% v/v was maintained throughout the process.

The concentration of biomass in the culture medium was monitored using a spectrophotometer at a wavelength of 550 nm . The equation derived based on the dry mass method was used in calculations: $\text{OD} (550) = 2.13 \cdot c_x [\text{g dm}^{-3}]$.

The substrate (benzene, toluene) concentration was determined using a GC-2014 gas chromatographer (Shimadzu, Japan) with a ZB-WAXplus capillary column (Zebron) that was 30 m long and 0.25 mm in diameter, covered with a $0.25\text{-}\mu\text{m}$ layer of polyethylene glycol. The samples were analysed under isothermal conditions in the column (temperature of the column 40°C , feeder 180°C and detector 200°C). These conditions allowed for separate peaks for benzene (4.02 min) and toluene (6.64 min). The concentration values were determined using standard curves: $A = 188502 \cdot c_{\text{benzene}} [\text{g dm}^{-3}]$ and $A = 150633 \cdot c_{\text{toluene}} [\text{g dm}^{-3}]$. The usable range of the standard curves was up to 1.6 g dm^{-3} for benzene and 0.4 g dm^{-3} for toluene.

The obtained values of the constants of the kinetic equation were validated by assessing a continuous process conducted in a BioFlo III (New Brunswick Scientific Edison) bioreactor. The broth contained benzene at a concentration of 0.18 g dm^{-3} and/or toluene at 0.18 g dm^{-3} and H_2O_2 at 0.02% v/v was dosed and stirred in the 1-litre bioreactor tank. The residence time (τ) varied from 135 to 248 h.

Bioremoval of benzene and toluene in an integrated system

Experiments were conducted using an MBR (Membrane Bioreactor) constructed by INSS-Pol (Poland) containing a stirred thermostated tank reactor with a volume of 14 litres and a microfiltration module with ceramic membrane pipe (FiltaniumTM), which was connected through stainless pipes to a ProScale Millipore apparatus fitted with an AFC 80 membrane.

During the first stage, the reactor operated like a classical MBR. Once the stationary state was achieved, the permeate stream from the microfiltration module was directed to the reverse osmosis module. Because the stream of permeate obtained from the reverse osmosis module was substantially greater than the planned outlet stream, the desired volume of permeate was received, and its surplus was returned to the reactor. For reasons of

transparency, the by-pass was not included in the figure. The surplus permeate from the RO module solved the problem, and the permeate stream decreased.

The concentration of the pollutants (benzene or toluene) and the biomass concentration were monitored in the streams leaving bioreactor and the reverse osmosis module. Steady state of the process was achieved after 18 days of operation, which at the residence time of 135 h amounted to over 3 volume exchanges.

Theory: A model of a bioreactor with cell and substrate retention

The proposed, expanded version of a membrane bioreactor is recommended for processes that require very low substrate concentrations in the outlet stream, such as in deep wastewater treatment. In a classical, continuous stirred tank reactor (CSTR) and a classical MBR, the outlet concentration is the same as the concentration in the reactor vessel. A very low concentration in the reactor leads to a very low reaction rate, resulting in an inefficient process.

In the expanded system, thanks to RO, the biomass and (at least partially) the substrate ($1 > R_s > 0$) could be returned to the reactor. Depending on the size of the substrate molecules, the system can operate under two modes:

1. High molecular substrates (e.g., proteins, polysugars, fats) could be separated on the same membrane as the biomass, using one UF module;
2. For low molecular substrates (e.g., BTEX), it is beneficial to use two modules: a microfiltration or ultrafiltration module to separate the biomass and a nanofiltration or reverse osmosis module to separate the substrate. A schematic diagram of the system is presented in Figure 3.

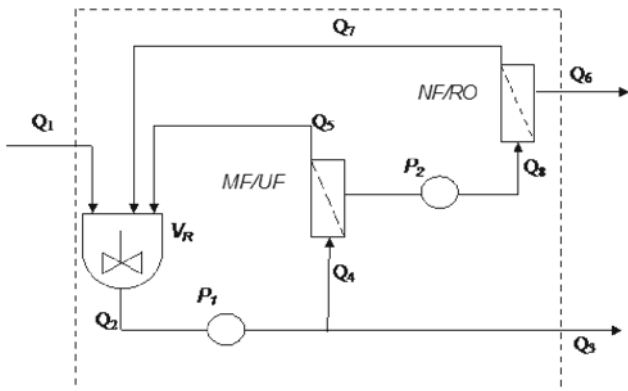

Figure 3. Schematic diagram of a bioreactor with two separation modules (VR – reactor volume, MF/UF – first step of filtration, NF/RO – second step of separation)

The model of a bioreactor with an MF membrane (classical MBR) has been described in the previously work^{7, 27}. The stream partition coefficient (Ψ) was introduced to the model, and using the definition of residence time, Equation (4) was obtained^{7, 27}.

$$\Psi = \frac{Q_1}{Q_3} \quad (3)$$

$$\tau = \frac{V_R}{Q_1} = \frac{1}{\mu \cdot \Psi} \quad (4)$$

In expanded version of the model, the MF/UF membrane entirely separates the biomass ($R_x=1$), hence

$$c_{X,2} = c_{X,3} = c_{X,4} \quad (5)$$

and the substrate is separated on the NF/RO module:

$$R_s = 1 - \frac{c_{S,6}}{c_{S,8}} \quad (6)$$

where

R_s – substrate retention coefficient

$$\text{Hence: } c_{S,2} = c_{S,3} = c_{S,4} = c_{S,5} = c_{S,8} \neq c_{S,6} \neq c_{S,7} \quad (7)$$

Balancing the equation of the substrate yields:

$$Q_1 \cdot c_{S,1} - Q_3 \cdot c_{S,2} - Q_6 \cdot c_{S,6} - V_R \cdot \frac{1}{Y_{X/S}} \cdot c_{X,2} \cdot \mu = 0 \quad (8)$$

where

V_R – bioreactor volume, dm^{-3}

Taking the stationary condition of the process:

$$Q_1 = Q_3 + Q_6 \quad (9)$$

the following relation is obtained:

$$c_{S,1} - c_{S,2} \cdot \left(1 - \frac{Q_6}{Q_1} \cdot R_s\right) = \frac{1}{Y_{X/S}} \cdot c_{X,2} \cdot \mu \cdot \frac{V_R}{Q_1} \quad (10)$$

Finally, using Equations (3), (4) and (9):

$$c_{S,1} - c_{S,2} \cdot \left[1 - R_s \cdot \left(1 - \frac{1}{\Psi}\right)\right] = \frac{1}{Y_{X/S}} \cdot c_{X,2} \cdot \frac{1}{\Psi} \quad (11)$$

at

$$c_{S,2} = \frac{K}{\mu_{\max} \cdot \tau \cdot \Psi - 1} \quad (12)$$

According to Equation (11), the variables of the process are Ψ , R_s , τ , K , and m_{\max} (included in $c_{S,2}$).

Although the substrate is separated by the membrane and returned in stream Q_7 to the reactor, its concentration in the reactor vessel (Equation (12)) does not depend on R_s . This interesting property of the microbial bioreactor occurs when the coefficient R_s increases and, thus, the substrate concentration in the feed stream Q_7 increases. Consequently, the biomass in the reactor (Equation (13)) also increases, leading to an increase in the degree of substrate conversion (Equation (14)). For substrate inhibition (Fig. 2), one residence time (one value of μ) corresponds to two states (i.e., two different biomass concentration and two different $c_{S,2}$), and the cell concentration at the initiation of the continuous process influences which state will be presumed.

$$X_2 = Y_{X/S} \cdot \Psi \cdot \left\{c_{S,1} - c_{S,2} \cdot \left[1 - R_s \cdot \left(1 - \frac{1}{\Psi}\right)\right]\right\} \quad (13)$$

$$\begin{aligned} \alpha_{MB(R_s > 0)} &= \frac{Q_1 \cdot c_{S,1} - Q_3 \cdot c_{S,3} - Q_6 \cdot c_{S,6} + Q_7 \cdot c_{S,7}}{Q_1 \cdot c_{S,1}} = \\ &= \frac{c_{S,1} - c_{S,2} \cdot \left[1 - R_s \cdot \left(1 - \frac{1}{\Psi}\right)\right]}{c_{S,1}} \quad (14) \end{aligned}$$

Substituting Equation (12) into (14), we get:

$$\alpha_{MB(R_s > 0)} = \frac{c_{S,1} - \left(\frac{K}{\mu_{\max} \cdot \tau \cdot \Psi - 1}\right) \cdot \left[1 - R_s \cdot \left(1 - \frac{1}{\Psi}\right)\right]}{c_{S,1}} \quad (15)$$

Based on Equation (15), Figure 4 shows the simultaneous effect of the value of R_s and Ψ on the degree of substrate conversion.

The value of $\Psi = 1$ corresponds to the CSTR. For all other values of coefficient Ψ , an increase in the value of R_s corresponds to an increase in the degree of substrate conversion degree, which is especially evident at

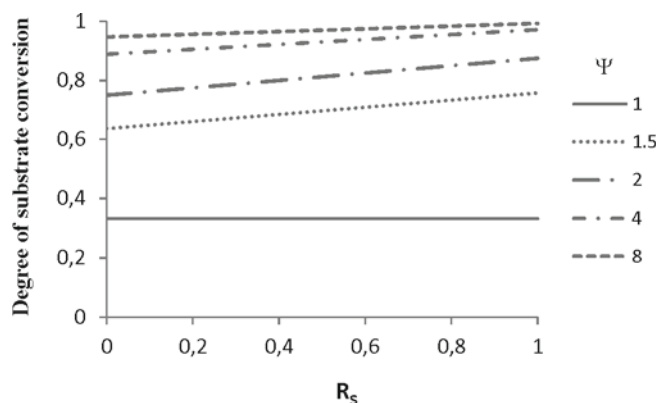

Figure 4. The simultaneous effect of the value of R_S and Ψ on the degree of substrate conversion (based on Equation (15))

lower values of Ψ (≤ 2). For higher values of Ψ , when $R_S = 0$, a high substrate conversion degree is obtained, which cannot be significantly increased. Therefore, the selection of parameters Ψ and R_S should be interrelated, as both parameters affect the efficiency of the reactor performance.

Schematically:

$$\alpha_{\text{MBR}} (R_S > 0) > \alpha_{\text{MBR}} (R_S = 0) > \alpha_{\text{CSTR}} \quad (16)$$

For the boundary cases:

$$\lim_{R_S \rightarrow 1} \alpha_{\text{MBR}} (R_S > 0) = 1 - \frac{c_{S,2}}{c_{S,1}} \cdot \frac{1}{\Psi} \quad (17)$$

$$\lim_{\Psi \rightarrow \infty} \alpha_{\text{MBR}} (R_S > 0) = 1 - \frac{c_{S,2}}{c_{S,1}} \cdot (1 - R_S) \quad (18)$$

RESULTS AND DISCUSSION

To validate the model and show the efficiency of the bioremoval process, two membrane separation modules were integrated with a stirred-tank bioreactor. Prior to the model validation, the following constants were determined in independent experiments:

- kinetic equation constants (K , m_{max}),
- biomass efficiency coefficient ($Y_{X/S}$),
- biomass retention coefficient (R_X) on the microfiltration/ultrafiltration membrane,
- substrate retention coefficient (R_S) on the nanofiltration/reverse osmosis membrane.

KINETIC STUDIES AND $Y_{X/S}$ COEFFICIENT ESTIMATION

A few cultures were inoculated with different initial concentrations of benzene or toluene (in the range of 0.01–0.24 g dm⁻³) at 24°C. However, substrate inhibition was so strong that, at higher concentrations of benzene (above 0.18 g dm⁻³) and toluene (above 0.15 g dm⁻³), no bacterial growth was observed despite a very long incubation (3 weeks). Strong inhibition of BTEX bioremoval at concentrations higher than 0.1–0.2 g dm⁻³ has also been previously reported^{25, 26}. In the range of substrate concentrations where it was possible, the rate of cell growth during the logarithmic phase was calculated, and these values are presented in Figure 5. The specific growth rates are very low, indicating that an intensification of the process via the biomass concentration is necessary.

Based on the experimental data, the constants (K and m_{max}) for the classical Monod equation, without consid-

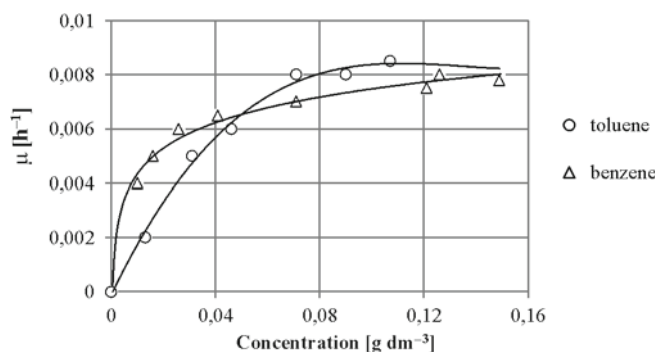

Figure 5. Kinetics (24°C) of benzene (Δ) and toluene (\circ) biodegradation by *P. fluorescens* strain (PCM 2123)

ering inhibition, were determined. Hence, the kinetic equation for benzene and toluene at 24°C takes the following form:

$$\mu = \frac{0.008 \cdot c_S}{0.0107 + c_S} \quad \text{for } c_{\text{benzene}} < 0.15 \text{ g dm}^{-3} \quad (19)$$

$$\mu = \frac{0.021 \cdot c_S}{0.119 + c_S} \quad \text{for } c_{\text{toluene}} < 0.11 \text{ g dm}^{-3} \quad (20)$$

The values of the constants of the above equations were validated using a continuous process. The residence times were 135, 148, 196, 220 and 248 h. For two residence times of 135 and 220 h, a process with both substrates in the reaction mixture was also conducted. The kinetics of their degradation appears independent (that is consistent with literature reports^{28, 29}) and there were no synergistic inhibitory effects. The concentration values obtained for each pollutant were similar (mean relative error of 8.93%) to the concentrations obtained from the pollutant mixture (Table 1). Both this finding and the different values of the kinetic constants suggest that the applied bacterial species use different enzymatic mechanisms in the catalytic degradation of benzene and toluene. The pathways of toluene degradation vary to a greater degree than those of benzene degradation³⁰.

Table 1. The outgoing concentration of benzene and toluene obtained in continuous process conducted in a Bio-Flo III bioreactor. The broth contained benzene at a concentration of 0.18 g dm⁻³ and/or toluene at 0.18 g dm⁻³. The residence time (τ) varied from 135 to 248 h

Concentrations [g dm ³] Residence time [h]	Single substrate		Mixture of substrates	
	Benzene	Toluene	Benzene	Toluene
135	0.128	0.066	0.123	0.063
148	0.057	0.056	–	–
196	0.019	0.039	–	–
220	0.014	0.033	0.017	0.035
248	0.011	0.028	–	–

Based on the continuous and batch cultures, the value of the biomass efficiency coefficient ($Y_{X/S}$), based on the method presented in the literature⁸, was determined. For example, for the batch culture shown in Figure 6 to calculate $Y_{X/S}$ the values at the beginning of the culture (at $t = 0$) and at $t = 200$ h (at maximum biomass concentration) were taken – Eq. (21).

$$Y_{X/S} = \frac{c_{X,\text{max}} - c_{X,0}}{c_{S,0} - c_{S(X_{\text{max}})}} = \frac{c_{X,200} - c_{X,0}}{c_{S,0} - c_{S,200}} \quad (21)$$

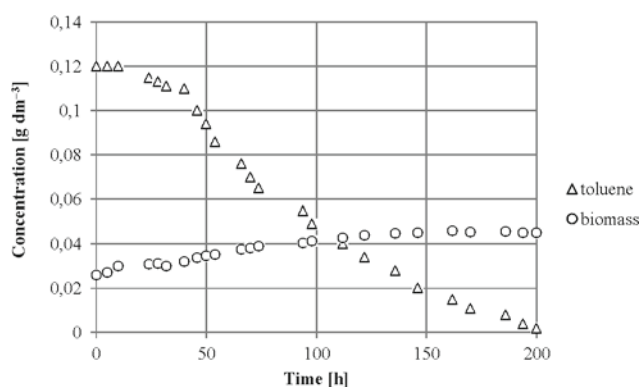

Figure 6. Batch process of toluene removal ($c_{s,0} = 0.12 \text{ g dm}^{-3}$, 24°C): (Δ) toluene concentration, (\circ) biomass concentration

For both benzene and toluene, the value was constant over the entire range of applied substrate concentrations and was equal to 0.16. This value is an extremely low biomass efficiency coefficient, likely because of the complex metabolic pathway of benzene and toluene degradation. Therefore, a substantial amount of organic compounds is used for the specific maintenance rate (m_s) of the “working” biomass, similarly as in another biodegradation processes^{31–33}.

Characteristics of the microfiltration process

A module with the microfiltration ceramic membrane was placed in a unit of our own design fitted with a back-flushing system and constructed by INSS-Pol (Poland). The membrane guaranteed full biomass retention ($R_X \cong 1$) and almost complete permeability of the substrates ($R_S = 0.012$). Due to the low biomass concentration of cells in the system, fouling on the membrane surface was not very intensive (decreases in the permeate flux by 12.3% after 24 h of circulation and by 28.6% after 3 days were observed). However, to maintain a constant permeate stream value at a given pressure, the reverse flow was set for 10 seconds every 15 minutes (experimentally selected parameters). Under these conditions, it was possible to maintain the stream at a nearly constant level.

A linear relationship of flux vs. operating pressure (in the range of 0–0.12 MPa) was expressed using a coefficient of membrane permeability, $L_{MF} = 1.04 \cdot 10^{-9} \text{ m}^3 \text{ N}^{-1} \text{ s}^{-1}$, at 24°C .

Characteristics of reverse osmosis process

The experiments were carried out using a ProScale Millipore apparatus with a stainless steel membrane module fitted with an AFC 80 membrane. The effects of pressure and the concentrations of benzene and toluene at the process temperature of 24°C (the same as inside the bioreactor) were examined. Figure 7 presents the influence of the selected parameters on the permeate flux. Over the operational pressure range of 1.1–3.5 MPa, the flux was linearly dependent on the pressure. No noticeable influence on the compounds was observed.

Figure 8 presents the averaged values of the retention coefficients for three series of measurements. For benzene, the values are high (0.85–0.92) and increased slightly with pressure. Similar values were obtained for the toluene solution at 0.25 g dm^{-3} . The values obta-

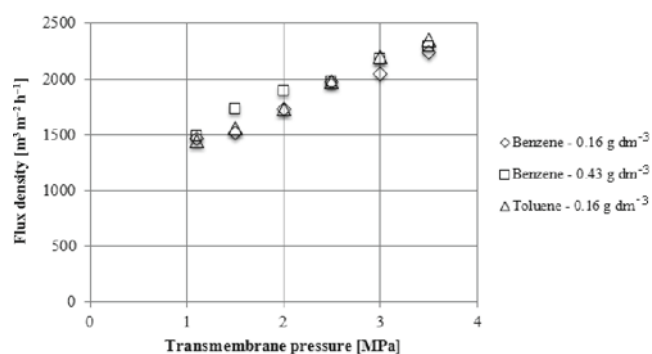

Figure 7. The effects of pressure and the concentrations of benzene and toluene at the process temperature of 24°C on the permeate flux (AFC 90 reverse osmosis membrane)

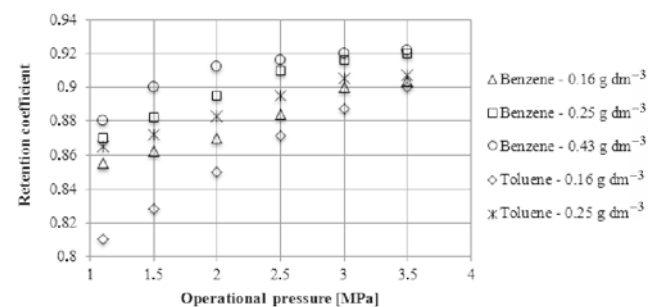

Figure 8. The outgoing concentration of benzene and toluene obtained in continuous process conducted in a BioFlo III bioreactor. The broth contained benzene at a concentration of 0.18 g dm^{-3} and/or toluene at 0.18 g dm^{-3} . The residence time (τ) varied from 135 to 248 h

ined for a very low concentration (0.16 g dm^{-3}) toluene solution were markedly different, as they were more strongly dependant on pressure. However, this particular series of experiments included the largest analytical error due to the very low concentration of toluene and its high volatility.

Both the permeate flux and the retention coefficients for toluene and benzene are more favourable at higher operational pressures of 1.1–3.5 MPa in the experiments. Therefore, a pressure of 3.5 MPa was selected for further investigation. The obtained values of the retention coefficients of toluene and benzene are higher (and thus better) than previously reported results of a nanofiltration process²⁷.

Bioremoval of benzene and toluene in an integrated system

Based on the experiments, the process parameters listed in Table 2 were selected. Under these parameters, the outgoing concentrations of the CSTR would be much higher than the maximum concentration of 1 mg dm^{-3} set by current standards.

The investigations were conducted over a residence time of 134 h for different values of the coefficient Ψ (1–6.98), which was achieved by changing the stream Q_3 . During the process, the pollutant concentration was monitored in streams Q_3 and Q_6 (Table 3). The concentration in the merged outgoing streams (Q_3 and Q_6) was also calculated using Equation (14), as presented in Figure 8. The average relative error of the model verification was 9.28% for benzene and 6.25% for toluene.

Table 2. The parameters applied during the bioremoval of benzene and toluene by *P. fluorescens* in the integrated (with two membrane units) system

Temperature [°C]	24
Tank reactor volume [dm ³]	10
Substrate (benzene or toluene) concentration in entering stream [g dm ⁻³]	0.18
Entering stream (Q ₁) volume [dm ³ h ⁻¹]	0.074
Hydraulic residence time (τ) [h]	135
Operational pressure on MF module [MPa]	0.04
Operational pressure on RO module [MPa]	3.5
Q ₃ stream volume [dm ³ h ⁻¹]	0.0106–0.074
Q ₆ stream volume [dm ³ h ⁻¹]	0–0.0634
Q ₈ stream volume [dm ³ h ⁻¹]	1.95
Stream partition coefficient (Ψ)	2.4–6.98
R _x on MF module	1
R _s on MF module	0.012
R _s on RO module	0.88 for toluene 0.89 for benzene

For a typical MBR ($R_s \approx 0$), the pollutant concentrations in the outgoing streams do not meet current standards, even for a high stream partition coefficient. Using additional (RO) membrane units for benzene at $R_s = 0.89$, the standards are met for a Ψ above 4. This conclusion was based on Figure 9 and verified experimentally (Table 3).

Regarding toluene, Q₃ cannot be merged with Q₆ because, even at Ψ approximately 7 and R_s 0.88, the concentration remains too high. However, the current standards are met if only stream Q₆ is considered when Ψ is equal to 7 (Table 3).

According to the results obtained by balancing the RO module (Equation (21)), the interrelation between the permeate streams from the MF (Q₈) and RO (Q₆) modules also exerts an effect on the concentration $c_{s,6}$.

$$\frac{Q_8}{Q_6} = \frac{R_s \cdot c_{s,6}}{c_{s,6} - (1 - R_s) \cdot c_{s,8}} \quad (21)$$

A higher ratio of the streams corresponds to the lower concentration of pollutant in the stream leaving the system. A large Q₈ stream can be relatively easily obtained by increasing the area of the microfiltration membrane or by increasing the transmembrane pressure. In the experiments performed here, the relation Q_8/Q_6 was very high (30.8–44.65).

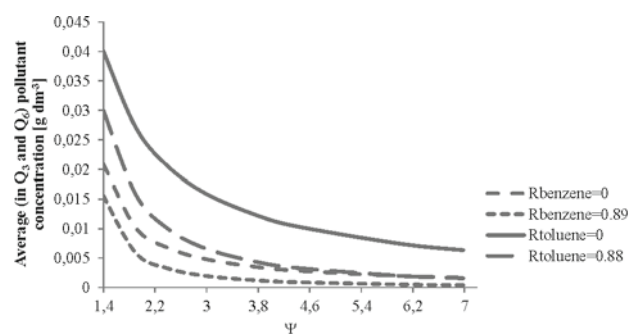
**Figure 9.** Average pollutant concentration in the merged outgoing (Q₃ and Q₆) streams as a function of Ψ and R_s (based on Equation (14))

CONCLUSION

The study presents a microbial reactor integrated with two membrane modules. Due to operational considerations, it is preferable to use one module for micro- or ultrafiltration for the biomass concentration and a second module for nanofiltration or reverse osmosis to separate the pollutants. Such a solution can be compared to the classical MBR and yields a lower concentration of the pollutants in the primary outgoing stream of the system (i.e., in the permeate stream from the NF/RO module). The two-module system presented here represents an interesting solution for the deep treatment of industrial wastewater and was derived via mathematical models and then experimentally validated.

The concentration of the pollutant in the stream outgoing from the system as the permeate from the RO unit (Q₆) is dependent primarily on R_s but also on τ , Ψ , the kinetic parameters (m_{\max} and K) and the Q_8/Q_6 relationship of the streams. Among these parameters, the most crucial factor is R_s , and hence, the choice of the membrane used to separate the biodegraded pollutant is critical.

The second outgoing stream, i.e., the biomass excess stream (Q₃), contains a higher concentration of the degraded substance, which is equal to the concentration in the reactor. If this concentration exceeds the limit value, the stream after the biomass separation must be returned back to the system for bioremoval.

An important question, which was not analysed in detail in this study, concerns the concentration of pollutants in the stream that is fed to the bioreactor. The range

Table 3. The experimental data of the bioremoval of benzene and toluene by *P. fluorescens* in the integrated (with two membrane units) system

Stream Q [dm ³ h ⁻¹]	Ψ = 2.39	Ψ = 3.61	Ψ = 6.98	Ψ = 2.39	Ψ = 3.61	Ψ = 6.98
	Q ₃ = 0.031 Q ₈ = 1.92 Q ₆ = 0.043	Q ₃ = 0.0205 Q ₈ = 1.94 Q ₆ = 0.063	Q ₃ = 0.011 Q ₈ = 1.94 Q ₆ = 0.063	Q ₃ = 0.031 Q ₈ = Q ₆ = 0.043	Q ₃ = 0.0205 Q ₈ = Q ₆ = 0.0535	Q ₃ = 0.011 Q ₈ = Q ₆ = 0.063
Concentration C _s [mg dm ³]	BENZENE			R _s ≈ 0.0		
	R _s = 0.89			R _s ≈ 0.0		
C _{s,3}	6.92	3.61	1.13	7.11 (6.72)	2.99 (3.32)	1.35 (1.56)
C _{s,6}	0.84	0.42	0.13			
Merged streams	3.37 (3.23)	1.24 (1.19)	0.32 (0.39)			
	TOLUENE			R _s ≈ 0.0		
	R _s = 0.88			R _s ≈ 0.0		
C _{s,3}	21.06	13.08	6.48	19.83 (20.50)	12.89 (12.22)	5.92 (6.33)
C _{s,6}	2.23	1.36	0.81			
Merged streams	10.03 (9.98)	4.75 (4.32)	1.56 (1.77)			

of concentrations over which the process runs without substrate inhibition is limited. To presume the stable state (at a lower concentration of pollutant) from the beginning of the integrated system, the continuous process should begin at a high biomass concentration, which must be obtained from a batch process under periodic dosing of the substrate. The biomass concentration should be close to the expected value at the steady state of the integrated process. The model given in Equation (13) can be used to estimate this value.

ACKNOWLEDGEMENT

The work was financed by a Statutory Activity Subsidy from the Polish Ministry of Science and Higher Education for the Faculty of Chemistry of Wrocław University of Technology (No. S40616/Z0311).

NOMENCLATURE

c_S	– substrate (pollutant) concentration, g dm^{-3}
c_X	– biomass concentration, g dm^{-3}
K	– Monod constant, kg m^{-3}
m_S	– specific maintenance rate, $\text{kg}_S \text{kg}_X^{-1} \text{s}^{-1}$
ΔP	– transmembrane pressure difference, Pa
R_S	– substrate retention coefficient
R_X	– biomass retention coefficient
r_S	– reaction rate, $\text{g dm}^{-3} \text{s}^{-1}$
Q	– volume stream, $\text{m}^3 \text{s}^{-1}$
T	– Temperature, $^{\circ}\text{C}$
t	– time, s
V_R	– bioreactor volume, dm^3
$Y_{X/S}$	– biomass yield coefficient, $\text{g}_X \text{g}_S^{-1}$

Greek letters

α_{MB}	– substrate conversion degree in membrane bioreactor
μ	– specific growth rate, h^{-1}
μ_{max}	– maximal specific growth rate, h^{-1}
τ	– hydraulic residence time, h
Ψ	– streams division coefficient

LITERATURE CITED

- Christensen, J.S. & Elton, J. (1996). *Soil and Groundwater pollution from BTEX*. Groundwater Pollution Primer. Civil Engineering Dept., Virginia Tech., USA <http://www.webapps.cee.vt.edu/ewr/environmental/teach/gwprimer/btex/btex.html>
- WHO guidelines for indoor air quality: selected pollutants. World Health Organization (2010). ISBN 978 92 890 0213 4.
- Vahatalo, A.V., Aamos, H. & Mantyniemi, S. (2010). Biodegradability continuum and biodegradation kinetics of natural organic matter described by the beta distribution. *Biogeochemistry* 100, 227–240. DOI: 10.1007/s10533-010-9419-4.
- Liu, L., Tindall, J.A., Friedel, M.J. & Zhang, W. (2007). Biodegradation of organic chemicals in soil/water microcosms system – Model development. *Water Air Soil Pollut.* 178, 131–143. DOI: 10.1007/s11270-006-9185-z.
- Balasubramanian, P., Philip, L. & Bhallamudi, S.M. (2011). Biodegradation of Chlorinated and Non-chlorinated VOCs from Pharmaceutical Industries. *Appl. Biochem. Biotechnol.* 163, 497–518. DOI: 10.1007/s12010-010-9057-2.
- Agarry, S.E. & Solomon, B.O. (2008). Kinetics of batch microbial degradation of phenols by indigenous *Pseudomonas fluorescens*. *Int. J. Environ. Sci. Tech.* 5(2), 223–232.

- Trusek-Holownia, A. (2011). *Membrane Bioreactors – Models for Bioprocess Design*. Desalination Publications, USA.
- Schleger, H.G. (1992). *Allgemeine microbiologie* (in German). Georg Thieme Verlag, Stuttgart, German.
- Zhang, X.W., Gong, X.D. & Chen, F. (1999) Dynamics and stability analysis of the growth and astaxanthin production system of *Haematococcus pluvialis*. *J. Industr. Microbiol. Biotechnol.* 23(2), 133–137.
- Monod, J. (1979). The growth of bacteria cultures. *Ann. Rev. Microbiol.* 3, 371–393.
- Meyers, R.A. (1995). *Molecular Biology and Biotechnology: A Comprehensive Desk Reference*, Wiley-VCH.
- Yerushalmi, L. & Guiot, S.R. (1998). Kinetics of biodegradation of gasoline and its hydrocarbon constituents. *Appl. Microbiol. Biotechnol.* 49, 475–481.
- Goudar, C.T. & Strevett, K.A. (1998). Comparison of relative rates of BTEX biodegradation using respirometry. *J. Ind. Microbiol. Biotechnol.* 21, 11–18. DOI: 1367-5435/98/\$12.00.
- Gödeke, S., Vogt, C. & Schirmer, M. (2008). Estimation of kinetic Monod parameters for anaerobic degradation of benzene in groundwater. *Environ. Geology* 55(2), 423–431. DOI: 10.1007/s00254-007-0988-z.
- Morlett-Chavez, J.A., Ascacio-Martinez, J.A., Rivas-Estilla, A.M., Velazquez-Vadillo, J.F., Haskins, W.E., Barrera-Saldana, H.A. & Acuna-Askar, K. (2010). Kinetics of BTEX biodegradation by a microbial consortium acclimatized to unleaded gasoline and bacterial strains isolated from it. *Intern. Biodeter. Biodegrad.* 64, 581–587. DOI: 10.1016/j.ibiod.2010.06.010.
- Plaza, G.A., Wypych, J., Berry C. & Brigmon, R.L. (2007). Utilization of monocyclic aromatic hydrocarbons individually and in mixture by bacteria isolated from petroleum-contaminated soil. *World J. Microbiol. Biotechnol.* 23, 533–542. DOI: 10.1007/s11274-006-9256-8.
- Nagarajan, K. & Loh, K.C. (2015). Formulation of microbial cocktails for BTEX biodegradation. *Biodegradation* 26 (1), 51–63. DOI: 10.1007/s10532-014-9715-0.
- Sevillano, E., Gallego, L. & García-Lobo, L.V. (2009). First detection of the OXA-40 carbapenemase in *P. aeruginosa* isolates, located on a plasmid also found in *A. baumannii*. *Pathologie Biologie* 57, 493–495. DOI: 10.1016/j.patbio.2008.05.002.
- Tomaszewska, M. (2007). Industrial wastewater treatment by means of membrane techniques. *Pol. J. Chem. Tech.* 9(3), 138–142. DOI: 10.2478/v10026-007-0074-z.
- Kabsch-Korbutowicz, M., Wisniewski, J., Lakomska, S. & Urbanowska, A. (2011). Application of UF, NF and ED in natural organic matter removal from ion-exchange spent regenerant brine. *Desalination* 280(1–3), 428–431. DOI: 10.1016/j.desal.2011.06.068.
- Gryta, M., Markowska-Szczupak, A., Grzechulska-Damszel, J., Bastrzyk, J. & Waszak, M. (2014). The study of glycerol-based fermentation and broth downstream by nanofiltration. *Pol. J. Chem. Tech.* 16(4), 117–122. DOI: 10.2478/pjct-2014-0081.
- Grzechulska-Damszel, J. & Morawski, A. (2007). Removal of organic dye in the hybrid photocatalysis/membrane processes system. *Pol. J. Chem. Tech.* 9(2), 94–98. DOI: 10.2478/v10026-007-0036-5.
- Lobos-Moysa, E., Dudziak, M. & Zon, Z. (2009). Biodegradation of rapeseed oil by activated sludge method in the hybrid system. *Desalination* 241(1–3), 43–48. DOI: 10.1016/j.desal.00.0.028229.
- Trusek-Holownia, A. (2011). Efficiency of alcohols biodegradation in a membrane bioreactor. *Deswater* 33, 389–395. DOI: 10.5004/dwt.2011.2413.
- Garcia Galan, M.J., Diaz-Cruz, M.S. & Barcelo, D. (2012). Removal of sulfonamide antibiotics upon conventional activated sludge and advanced membrane bioreactor treatment. *Anal. Bioanal. Chem.* 404, 1505–1515. DOI: 10.1007/s00216-012-6239-5.
- Shim, H., Shim, E. & Yang, S.T. (2002). A continuous fibrous-bed bioreactor for BTEX biodegradation by a co-culture

of *Pseudomonas putida* and *Pseudomonas fluorescens* Adv. Environ. Res. 7, 203–216. DOI: 10.1016/S1093-0191(01)00132-0.

27. Trusek-Holownia, A. & Noworyta, A. (2012). Advanced treatment of wastewater with BTEX. *Deswater* 50, 440–445. DOI: 10.1080/19443994.2012.705089.

28. Otenio, M.H., Lopes da Silva, M.T., Marques, M.L.O., Roseiro, J.C. & Bidoia E.D. (2005). Benzene, toluene and xylene biodegradation by *Pseudomonas putida* CCMI 852. *Brazil. J. Microbiol.* 36, 258–261.

29. Di Martino, C., Lopez, N.I. & Iustman, L.J.R. (2012) Isolation and characterization of benzene, toluene and xylene degrading *Pseudomonas* sp. selected as candidates for bioremediation. *Intern. Biodeter. Biodegrad.* 67, 15–20. DOI: 10.1016/j.ibiod.2011.11.004.

30. Alvarez, P.J.J. & Vogel, T.M. (1995). Degradation of BTEX and their aerobic metabolites by indigenous microorganisms under nitrate reducing conditions. *Wat. Sci. Technol.* 31, 15–28.

31. Marsolek, M.D., Kirsits, M.J. & Rittmann, B.E. (2007). Biodegradation of 2,4,5-trichlorophenol by aerobic microbial communities: biorecalcitrance, inhibition, and adaptation. *Biodegradation* 18, 351–358. DOI: 10.1007/s10532-006-9069-3.

32. Song, Z., Edwards, S.R. & Burns, R.G. (2005) Biodegradation of naphthalene-2-sulfonic acid present in tannery wastewater by bacterial isolates *Arthrobacter* sp. 2AC and *Comamonas* sp. 4BC. *Biodegradation* 16, 237–252.

33. Trusek-Holownia, A. & Noworyta, A. (2012). Biological regeneration of liquid sorbents after industrial purification of outlet gases. *Chem. Process Eng.* 33, 667–678. DOI: 10.2478/v10176-012-0056-4.