

Vibration control of rotors mounted in hydrodynamic bearings lubricated with magnetically sensitive oil by changing their load capacity

Jaroslav ZAPOMĚL^{1, 2*} and Petr FERFECKI^{1, 3}

¹Department of Applied Mechanics, VSB – Technical University of Ostrava, Ostrava, Czech Republic

²Department of Dynamics and Vibration, Institute of Thermomechanics, Prague, Czech Republic

³IT4Innovations National Supercomputing Center, VSB – Technical University of Ostrava, Ostrava, Czech Republic

Abstract. Rotors of rotating machines are often mounted in hydrodynamic bearings. Loading alternating between the idling and full load magnitudes leads to the rotor journal eccentricity variation in the bearing gap. To avoid taking undesirable operating regimes, its magnitude must be kept in a certain interval. This is offered by the hydrodynamic bearings lubricated with smart oils, the viscosity of which can be changed by the action of a magnetic field. A new design of a hydrodynamic bearing lubricated with magnetically sensitive composite fluid is presented in this paper. Generated in the electric coil, the magnetic flux passes through the bearing housing and the lubricant layer and then returns to the coil core. The action of the magnetic field on the lubricant affects the apparent fluid viscosity and thus the position of the rotor journal in the bearing gap. The developed mathematical model of the bearing is based on applying the Reynolds equation adapted for the case of lubricants exhibiting the yielding shear stress. The results of the performed simulations confirmed that the change of magnetic induction makes it possible to change the bearing load capacity and thus to keep the rotor journal eccentricity in the required range. The extent of control has its limitations. A high increase in the loading capacity can arrive at the rotor forced vibration's loss of stability and induce large amplitude oscillation.

Key words: magnetically sensitive lubricant; controllable hydrodynamic bearings; controllable load capacity; rigid rotors.

1. INTRODUCTION

Loading of rotating machines produced by realization of several technological processes remains mostly constant, changing between the minimum and maximum values. Its increase or drop often has an impulsive character. To reduce the magnitude of the induced vibration and forces transmitted to the machine foundations, the widely used technical solution consists of applying the support elements exhibiting a sufficient amount of damping. This is offered by hydrodynamic bearings. To achieve their optimum performance, their parameters must be adapted to the current operating conditions. This is enabled by a number of control concepts based on different physical principles: pneumatic, hydraulic, electric-hydraulic, and electric-mechanical. Wu and Pfeiffer [1] introduced a design variant of a journal bearing, the stiffness of which was controlled by the change of the oil inlet into the bearing gap. Krodkiwski and Sun [2] reported on a journal bearing having the lining formed by a flexible sleeve, the shape of which was changed through control of the liquid pressure in pressure chambers designed under the sleeve. Another concept based on the utilization of piezoelectric elements in a journal bearing system was reported by Przybyłowicz [3]. The active part is a piezoelectric ring placed between the bearing shell and the bearing housing. Under the application of

the electric field, the piezoelectric ring increases or decreases its radial dimension, which changes the width of the bearing gap. The required dimension of the bearing clearance depends on the rotor angular velocity. The electro-dynamic concept of a bearing intended for supports of high-speed rotors is reported in [4].

A new approach to controlling the hydrodynamic bearing load capacity consists of the application of magnetically sensitive oils. The action of a magnetic field on the lubricant affects its apparent viscosity, and it changes the magnitude of the hydraulic force acting on the rotor journal. The ferromagnetic fluids themselves are too weak to be possibly used to control the load capacity of journal bearings [5]. The application of magnetorheological fluids is reported by Wang *et al.* [6]. The simulation results show that the magnetorheological fluids are applicable for suppressing rotor systems' vibration and altering their critical speed. Their disadvantage is the sedimentation of ferromagnetic particles.

In this paper, a new design concept of a hydrodynamic bearing lubricated with ferrofluid-based magnetorheological oil is introduced, and its effect on the rotor oscillation and stability of its motion is studied. The proposal of the bearing and investigation of its response on the change of the current powering the electric coil that is the source of the magnetic flux is reported in [7]. The influence of the change of a magnetic field acting on magnetically sensitive oils used as lubricants in hydrodynamic bearings on their load capacity was studied in [8]. The main considerations on the properties and application of composite magnetic fluids are discussed in [9].

*e-mail: jaroslav.zapomel@vsb.cz

Manuscript submitted 2021-03-27, revised 2021-06-01, initially accepted for publication 2021-06-21, published in December 2021

This paper focuses on the operation regime when the rotor is suddenly loaded due to the performance of the technological process to avoid rupture of the lubricating film and not induce vibration of large amplitude due to the sudden drop of loading of the rotating machine. The model-based investigations show that the controllable hydrodynamic bearings lubricated by magnetically sensitive fluids make it possible to ensure optimum running conditions of rotors loaded by non-stationary repeated forces of large magnitude.

The main contributions of the paper consist in (i) adapting the Reynolds equation for the non-Newtonian lubricants exhibiting yielding shear stress, (ii) confirmation of practical applicability of controlling the position of the journal in the gap of a hydrodynamic bearing using magnetically sensitive fluids, and (iii) cognition of the effect of hydrodynamic bearings lubricated by magnetically sensitive fluids on the vibration of rigid rotors during the change of loading conditions.

2. DESIGN AND MODELLING OF THE PROPOSED HYDRODYNAMIC BEARING

The bearing housing of the proposed hydrodynamic bearing (Fig. 1) consists of a casing and a pin, both made of ferromagnetic material. There is a hole in the front end of the casing in which a hollow journal is inserted. A magnetically sensitive lubricant is supplied into the gap between the outer surface of the journal and the inner surface of the hole. The pin is equipped with the electric coil, a source of magnetic flux passing through the bearing casing, the gap filled with magnetically sensitive oil, the wall of the hollow journal and the air gap, respectively, and returns to the pin. The journal is made of non-ferromagnetic material, preventing its attraction to the pin or the bearing casing.

The bearing is lubricated with the ferrofluid-based magnetorheological oil. The carrying liquid is a ferromagnetic fluid in which ferromagnetic particles of micrometre size are dispersed. If affected by a magnetic field, the lubricant becomes a non-Newtonian fluid exhibiting the yielding shear stress. The change of magnetic induction of the magnetic field passing through the oil layer changes resistance against its flow, which alters the damping and stiffness of the hydrodynamic bearing.

In the mathematical model, the bearing housing and the shaft journal are considered absolutely rigid.

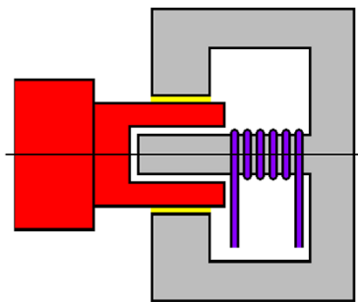

Fig. 1. The proposed controllable hydrodynamic bearing

To determine the magnetic flux passing through the lubricant, the bearing housing is composed of a set of meridian segments, each of which represents one branch of a magnetic circuit. The magnetic flux distribution in the individual branches is governed by the Kirchhoff and Hopkinson laws [10]. Magnetic reluctance is inverse proportional to the relative permeability. The material of the non-ferromagnetic journal and media filling the gaps between the pin and the inner surface of the hole in the bearing casing has a relative permeability of three or four orders lower than the ferromagnetic material of the pin and the bearing housing. Therefore, the magnetic reluctance of the ferromagnetic parts of the magnetic circuit was neglected.

Then dependence of magnetic induction on the applied current reads as

$$B = k_D \mu_0 \frac{I}{R_B - R_p}, \quad (1)$$

where B is magnetic induction in the bearing gap, I is the applied electric current, μ_0 is the permeability of vacuum, R_B is the bearing radius, R_p is the pin radius, and k_D is the design parameter, which represents the number of the coil turns and takes into account leakage of magnetic flux out of the magnetic circuit. More details for its determination can be found in [11].

Determination of the pressure distribution in the lubrication layer is based on assumptions of the classical theory of lubrication except that for the lubricant. It is assumed that the geometric parameters make it possible to consider the bearing as long. The oil is a non-Newtonian liquid exhibiting the yielding shear stress. The mathematical model is represented by bilinear material, the yielding shear stress of which depends on magnetic induction. As the thickness of the oil film is much lower than the hole's radius in the front end of the bearing casing, its magnitude is considered constant around the circumference and along the length of the bearing gap.

The yielding shear stress depends on the flow rate, which changes both in the circumferential and radial directions in the oil film. Implementation of this yielding shear stress distribution in the Reynolds equation is required to perform its modification as follows:

- the lubricating film is divided in the radial direction into sublayers,
- the oil in each sublayer is considered as Newtonian material,
- the equality of the shear stress and the circumferential velocity at locations of the contact of two neighbouring sublayers is ensured by application of the boundary conditions,
- as material in each sublayer is Newtonian, the apparent viscosity is constant, and its value is determined from the flow curve and the average sublayer velocity rate.

Derivation of the modified Reynolds equation starts from the equation of equilibrium of the infinitesimally small element specified in the K -th lubricant sublayer, in which the fluid's behaviour is considered Newtonian, and from the Newton formula for the relation between the shear stress and the velocity gradient. Utilizing the procedure described in [12] and [13] yields the velocity profile in the K -th sublayer

$$u_K = \frac{1}{2R\eta_{AK}} \frac{\partial p}{\partial \varphi} Y^2 + C_{1K}Y + C_{2K}, \quad (2)$$

Y is the radial coordinate, u_K is the circumferential velocity in the K -th sublayer, p is the pressure, η_{AK} is the apparent viscosity of the K -th sublayer, R is the journal radius, and φ is the circumferential coordinate. The integration constants C_{1K} , C_{2K} are determined by means of application of the boundary conditions related to the contact between the liquid and the liner and journal surfaces and between the individual oil sublayers.

The flow rate in the circumferential direction Q_φ is obtained by integration of the flow velocity across the width of the bearing gap

$$Q_\varphi = \sum_{K=1}^N \int_{Y_{K-1}}^{Y_K} u_K dY, \quad (3)$$

Y_K and Y_{K-1} are the radial coordinates of the surfaces specifying the K -th sublayer and N is the number of the fluid sublayers.

Condition of the flow continuity and some manipulations described in [12, 13] give the Reynolds equation adapted for lubricants exhibiting the yielding shear stress

$$\begin{aligned} -\frac{1}{R_B^2} \frac{\partial}{\partial \varphi} \left[\frac{\partial p}{\partial \varphi} G_P [h(\varphi), \eta_A(B)] \right] = \\ = -\omega \frac{\partial}{\partial \varphi} G_C [h(\varphi), \eta_A(B)] + \dot{h}, \end{aligned} \quad (4)$$

h is the thickness of the lubricant layer, η_A is the apparent viscosity of the lubricant, ω is the angular velocity of the journal rotation, G_P is the term corresponding to the pressure-induced flow (Poiseuille flow), G_C is the term related to the velocity induced flow (Couette flow), and (\cdot) denotes the first derivative with respect to time.

As the bearing is considered as long, the boundary conditions are given by the pressure at locations of the oil inlets to the bearing gap.

In regions where the pressure drops to the critical value, cavitation is assumed. In the developed mathematical model, the pressure of the oil-gas mixture in cavitated areas is constant, and its magnitude is equal to the atmospheric pressure.

The horizontal and vertical components of the hydraulic force, by which the oil layer acts on the shaft journal, are calculated by integration of the pressure distribution in the oil film around the circumference and along the length of the bearing

$$F_{hy} = -L_B R_B \int_0^{2\pi} p_d \cos \varphi d\varphi, \quad (5)$$

$$F_{hz} = -L_B R_B \int_0^{2\pi} p_d \sin \varphi d\varphi, \quad (6)$$

F_{hy} , F_{hz} are the y and z components of the hydraulic force acting on the shaft journal, L_B denotes the bearing length, and p_d is the pressure distribution in the oil film, taking into account

different pressure profiles in the full oil film and in cavitation regions.

The lubricant is a composite liquid. It is composed of concentrated ferrofluid, in which particles of a micrometre size are dispersed. If no magnetic field is applied, the fluid behaves as a normal Newtonian one. Under a magnetic field, the micrometre size particles start to form a chain structure, which induces the yielding shear stress. The liquid starts to flow only if the shear stress between two neighbouring layers is higher than the yielding shear stress. The nano-size particles take positions between the large ones, which increases the strength of the particle chains. The magnitude of the yielding shear stress depends on magnetic induction.

Magnetically sensitive composite liquids were a subject of a study, which resulted in the formulation of the relation between the yielding shear and magnetic induction [9]

$$\begin{aligned} \tau_y = c_1 \left(\frac{B}{B^*} \right)^2 \left[1 - \tanh \left(\frac{B}{B^*} \right) \right] + \\ + c_2 \Phi^n \left(\frac{B}{B^*} \right)^m \tanh \left(\frac{B}{B^*} \right), \end{aligned} \quad (7)$$

where

$$\Phi = \Phi_{micro} (1 - \Phi_{nano}) + \Phi_{nano}, \quad (8)$$

τ_y is the yielding shear stress, Φ is the volume concentration of the ferromagnetic particles in the lubricant, Φ_{micro} is the volume concentration of the particles of a micrometre size, Φ_{nano} is the volume concentration of the particles of a nanometre size, and B^* , c_1 , c_2 , n , m are material constants, the values of which were obtained by measurements [9].

3. THE SIMULATED ROTOR SYSTEM

The investigated rotor is rigid. It consists of a shaft and one disc. At both its ends, it is supported by magnetically controlled hydrodynamic bearings. The rotor rotates at constant angular speed, is loaded by its weight and by a time variable applied force, the magnitude of which changes suddenly and acts on the disc in the same direction as the gravitational force. Moreover, the rotor is excited by the disc imbalance. The whole system can be considered symmetric relative to the middle disc plane.

The diagram of the rotor system and the introduced frame of reference can be seen in Fig. 2.

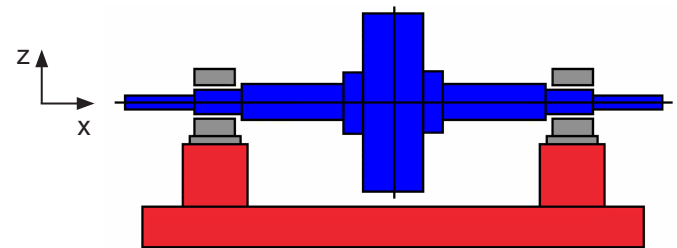

Fig. 2. Diagram of the analyzed rotor system and the introduced frame of reference

The inner surface of the bearing bushing is divided by two deep axial grooves, into which the magnetically sensitive lubricant is supplied.

As the rotor is rigid and symmetric, its lateral vibration is governed by two motion equations

$$m\ddot{y} + b_p\dot{y} = me_T\dot{\vartheta}^2 \cos\vartheta + 2F_{hy}, \quad (9)$$

$$m\ddot{z} + b_p\dot{z} = me_T\dot{\vartheta}^2 \sin\vartheta - mg + 2F_{hz} - F, \quad (10)$$

m is the rotor mass, b_p is the coefficient of damping produced by the environment, g is the gravity acceleration, e_T is the eccentricity of the rotor centre of gravity, F is the applied force, y , z are lateral displacements of the rotor centre in the horizontal and vertical directions, respectively, ϑ is the angle of the rotor rotation, and $(\ddot{})$ denotes the second derivative with respect to time.

The explicit Euler method was applied to solve the motion equations. The Reynolds equation modified for non-Newtonian lubricants exhibiting the yielding shear stress and for the case of long bearings was solved by means of the central difference method. As the apparent viscosity is a function of the velocity rate, the velocity profiles needed for its calculation were taken from the pressure distribution and the kinematic parameters of the system calculated in the previous integration step.

4. THE SIMULATION RESULT

The main design and operation parameters of the investigated rotor system are summarized in Table 1.

Table 1
Input parameters of the simulations

| Rotor parameters | |
|--|------------------|
| Rotor mass | 430 kg |
| The eccentricity of the disc centre of gravity | 50 μm |
| Bearing length | 60 mm |
| Journal diameter | 60 mm |
| Bearing clearance | 0.2 mm |
| Design parameter | 900 |
| Oil viscosity (not affected by a magnetic field) | 0.06 Pas |

The relations for determining the yielding shear stress and the corresponding oil material constants obtained by measurements were taken from [9].

Dependence of magnetic induction in the bearing clearance and the yielding shear stress of the lubricant on the applied current is evident from Figs. 3 and 4.

The investigated rotor rotates at a constant angular speed of 300 rad/s. Its weight loads it by a constant force of magnitude of 5 kN, which acts on the disc in direction z and is excited by the disc imbalance (eccentricity 50 μm).

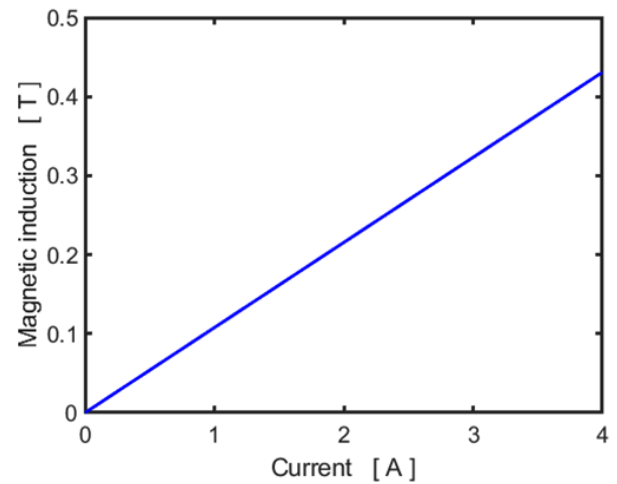

Fig. 3. Magnetic induction in the bearing gap in dependence on current

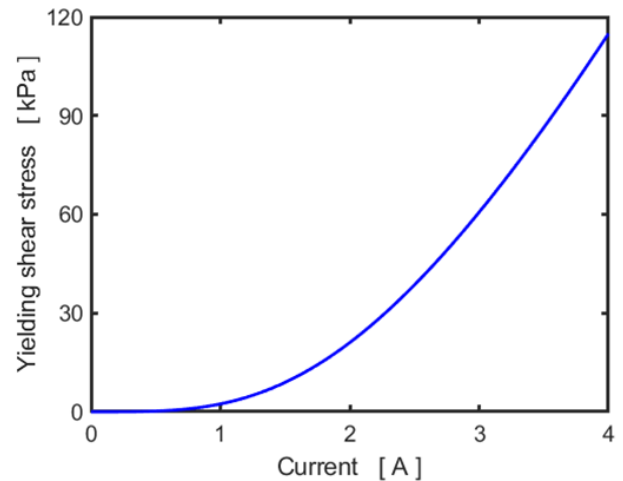

Fig. 4. Yielding shear stress of the lubricant in dependence on current

The first set of simulations is related to the case when no current is applied (0.0 A). At the point of time of 0.5 s, the stationary force suddenly increases to 30 kN (Fig. 5). The trajectory of the rotor journal centre during the transient period and positions of the steady state orbits in the bearing gap before and after the force increase are drawn in Figs. 6 and 7. An increase in the stationary force leads to a significant shift of the journal towards the wall of the bearing lining.

Figure 8 shows the time history of the rotor journal centre relative eccentricity. Its mean value rises from about 60% to 91%. It implies that the clearance between the journal and the bearing lining becomes too small after the load increase. This can arrive at rubbing due to the surface asperities or the presence of impurity particles contained in the oil.

The second set of simulations aimed to investigate the utilization of magnetically sensitive oils for increasing the load capacity of the hydrodynamic bearings. The rotor rotates at

Vibration control of rotors mounted in hydrodynamic bearings lubricated with magnetically sensitive oil by changing their load capacity

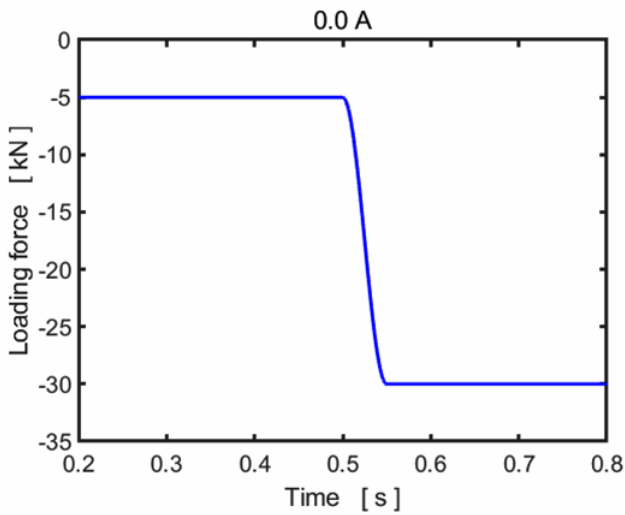

Fig. 5. Time history of the loading force

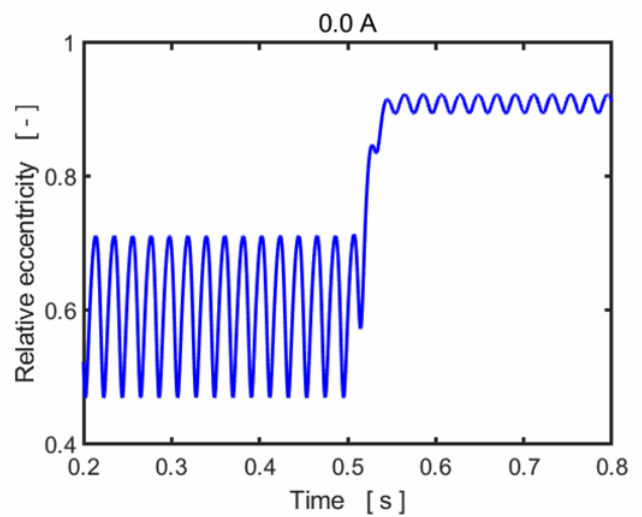

Fig. 8. Time history of the rotor journal centre relative eccentricity (change of loading)

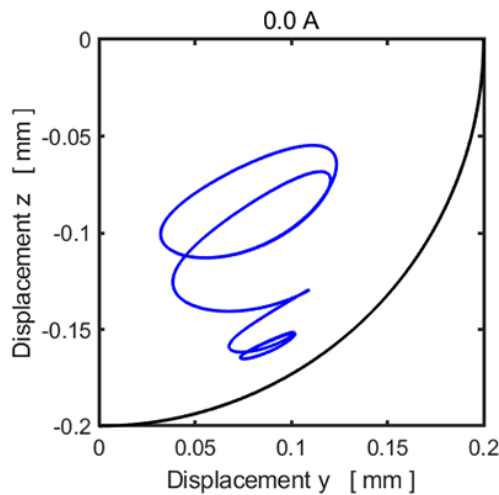

Fig. 6. The transient trajectory of the journal centre (change of loading)

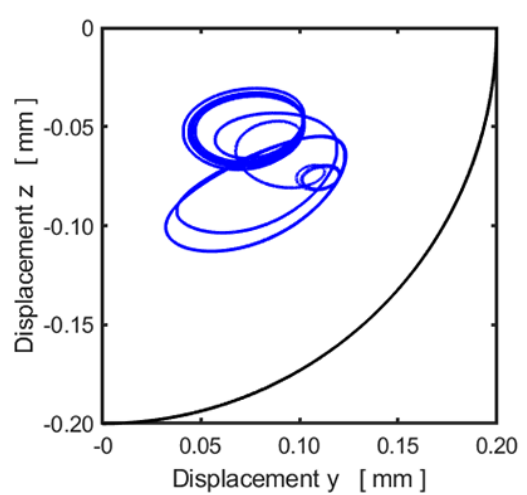

Fig. 9. The transient trajectory of the journal centre (change of the applied current and the loading)

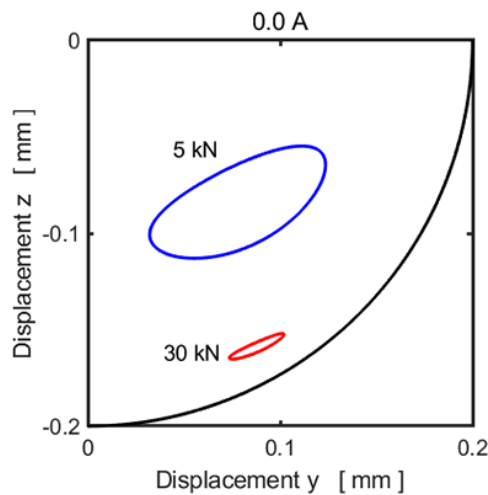

Fig. 7. Steady-state orbits for the loading of 5 kN and 30 kN

a constant angular speed of 300 rad/s, is loaded by its weight and the constant loading force having a magnitude of 5 kN, which acts on the disc of the rotor in direction z and is excited by the disc imbalance. At the time of 0.5 s, the current of 3.0 A is applied (the time of the current increase is 50 μ s), and at the time of 1.0 s, the stationary force rises. The system response is evident from Figs. 9 and 10, in which the trajectory of the journal centre and positions of its steady state orbits is depicted. The applied electric current generates magnetic flux that passes through the bearing gap. It increases the oil yielding shear stress and moves the rotor journal trajectory towards the bearing centre. An increase in the stationary force pushes the journal to the bearing linen, but the mean relative eccentricity and its maximum value reach only 67 and 71%, respectively (Fig. 11), which is much less than 91% in the case when no current was applied. This indicates that the action of the magnetic field on the oil increases the bearing load capacity.

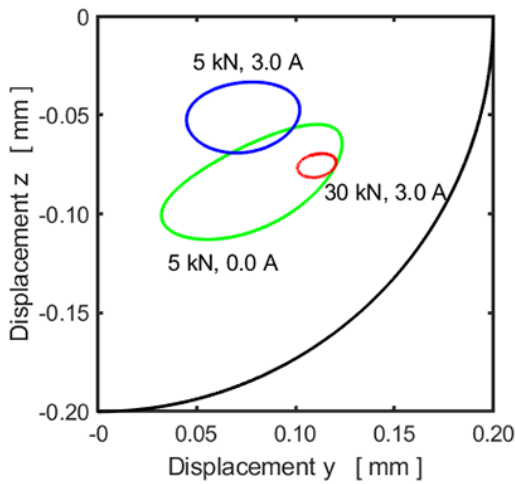

Fig. 10. Steady state orbits for the loading of 5 kN and 30 kN and current of 0.0 and 3.0 A

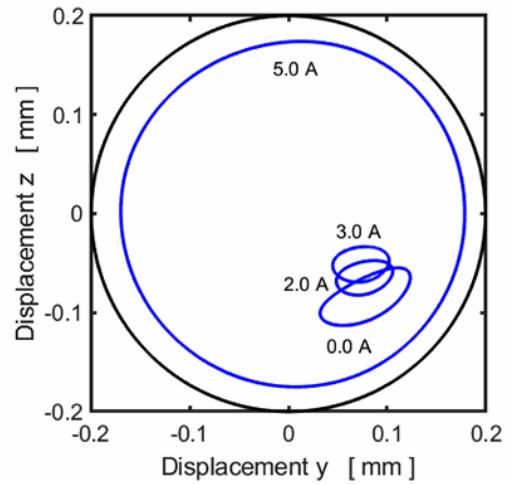

Fig. 12. Steady state orbits of the rotor journal centre for currents 0.0, 2.0, 3.0, 5.0 A

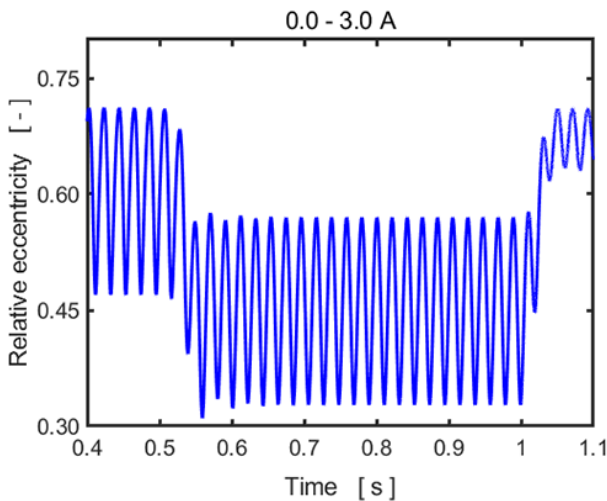

Fig. 11. Time history of the rotor journal centre relative eccentricity (change of the current and loading)

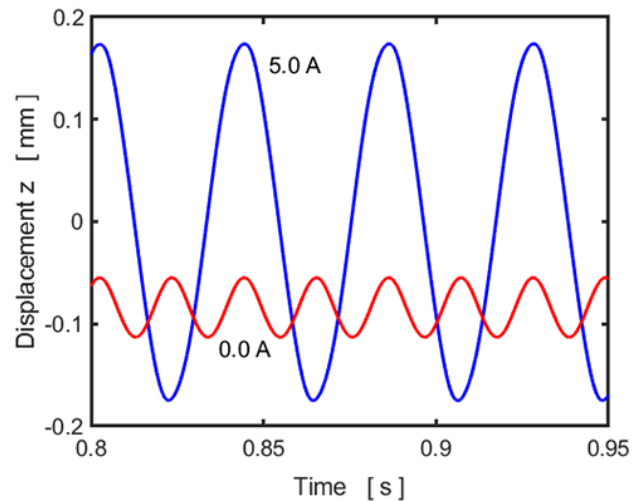

Fig. 13. Time history of the rotor z-displacement for currents of 0.0 and 5.0 A

From the physical point of view, applying the current induces the lubricant yielding shear stress, increasing its apparent viscosity and raising the oil film stiffness. Higher stiffness shifts the orbit towards the bearing center, reduces the rotor journal vibration amplitude, and the orbit becomes smaller. Consequent increase of the loading force pushes the journal towards the bearing linen, which further increases the oil film stiffness due to higher eccentricity and reduces vibration amplitude of the rotor journal and the size of the orbit.

Rising load capacity moves the rotor journal towards the bearing centre and thus reduces the stability of the steady state component of the rotor forced vibration induced by the imbalance. In the third analyzed case, the rotor rotates at a constant angular speed of 300 rad/s. It is loaded by its weight, by the stationary force of magnitude of 5 kN acting on the disc in the vertical direction, and by the disc imbalance (eccentricity 50 μm).

Figure 12 shows the steady state orbits for the rising magnitude of the applied current (2.0, 3.0, and 5.0 A). Time histories of the rotor displacement in the vertical direction for the currents of 0.0 and 5.0 A are depicted and compared in Fig. 13.

As evident, when the current exceeds the critical value, the forced vibration induced by the rotor unbalance becomes unstable, the bifurcation takes place, and the subharmonic component of large amplitude appears, the size of the orbit rises, and the period of the rotor vibration doubles.

The bifurcation diagram is depicted in Fig. 14. The rotor vibration is forced for the currents between 0.0 and 4.0 A, excited by the disc unbalance. Its period is equal to the period of the rotor rotation. If the applied current exceeds this interval, the subharmonic component of large magnitude is induced, and the oscillation period is doubled.

Figures 15 and 16 show the distribution of apparent viscosity in the layer of lubricant. The results are related to an arbitrary

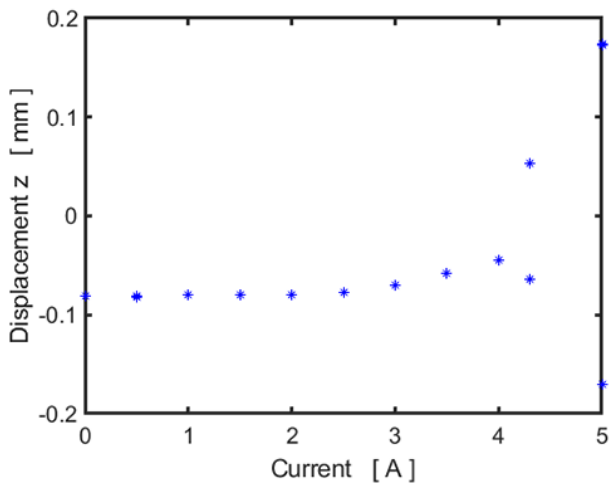

Fig. 14. Bifurcation diagram (current – z displacement)

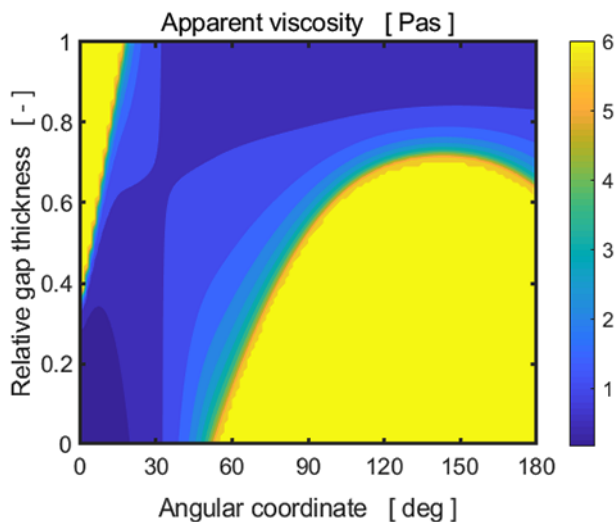

Fig. 15. Distribution of apparent viscosity (3.0 A) upper segment

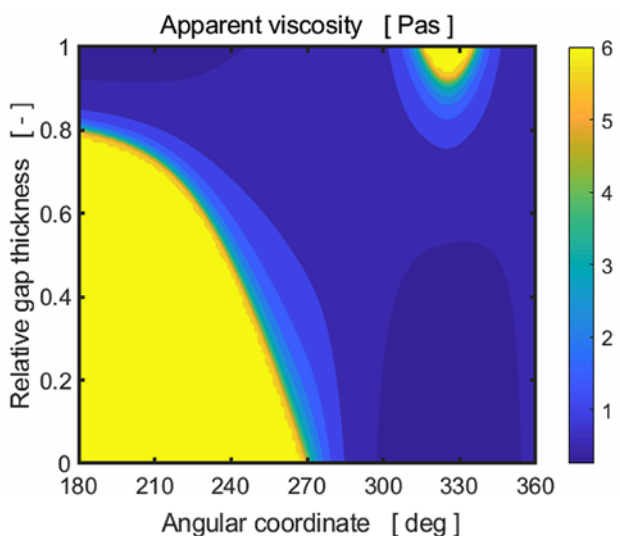

Fig. 16. Distribution of apparent viscosity (3.0 A) lower segment

trarily chosen moment. The rotor rotates at an angular velocity of 300 rad/s and is loaded by the stationary force of 30 kN. The magnitude of the applied current is 3.0 A.

It is evident that the core where the oil behaviour approaches to solid substance is formed at two locations (locations of maximum viscosity), both in the gap of the upper and lower segments. The distribution of the apparent viscosity is not continuous in the axial direction because the segments are mutually separated by deep axial grooves, into which the oil is supplied in the bearing.

Position of the orbit in the bearing gap and position of the rotor journal centre (marked by the star) related to the moment, at which distribution of the apparent viscosity depicted in Figs. 15 and 16 is related, are drawn in Fig. 17. The velocity of the journal center is 1.82 mm/s at this point in time.

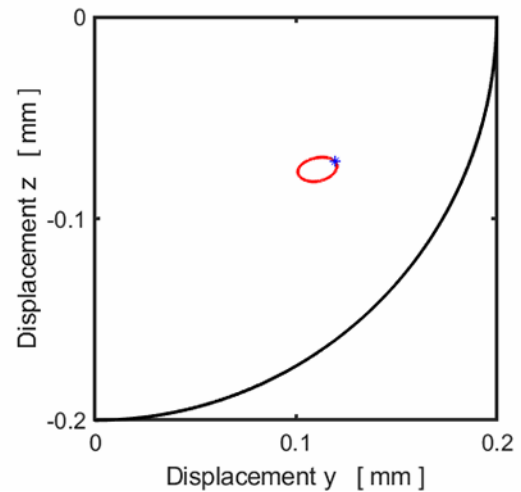

Fig. 17. Position of the journal centre in the bearing gap

5. CONCLUSIONS

This study's principal objective was to investigate the controllable hydrodynamic bearings lubricated by magnetically sensitive fluid used to support rigid rotors. The research aimed to achieve their optimum performance when rotors are loaded by stationary forces suddenly changing their magnitudes. The bearings are lubricated by composite magnetic fluid consisting of a concentrated ferrofluid used as carrying liquid, in which ferromagnetic particles of micrometre size are dispersed. The computer modelling method was used to carry out the research. The results of the computational simulations confirmed that rising current (rising magnetic induction in the oil film) increases the load capacity of the bearing. This makes it possible to increase the extent of rotors loading and suppress the rotor undesirable operating regimes. The simulations also showed that the extent of the control of the bearing is limited. Too high current can arrive at inducing vibration of large amplitude. The proposed technological solution has several advantages. The bearing response on the application of the current is fast, and the bearing can work only in the on/off control regime. It implies no complicated and expensive control system is needed.

ACKNOWLEDGEMENTS

The presented work was supported by the Czech Science Foundation (grant project 19–06666S) and by the Doctoral grant competition VSB – Technical University of Ostrava, reg. no. CZ.02.2.69/0.0./0.0/19_073/0016945 within the Operational Programme Research, Development and Education, under project DGS/TEAM/2020–033 “Development of Computational Algorithms for Solution of Nonlinear Structural Dynamical Problems with Utilization of ESPRESO Numerical Library”.

REFERENCES

- [1] W.-X. Wu and F. Pfeiffer, “Active vibration damping for rotors by a controllable oil-film bearing,” in *Proc. of the Fifth International Conference on Rotor Dynamics*, 1998, pp. 431–442.
- [2] J.M. Krodkiewski and L.D. Sun, “Modelling of multi-bearing rotor systems incorporating an active journal bearing,” *J. Sound Vib.*, vol. 210, no. 3, pp. 215–229, 1998.
- [3] P.M. Przybyłowicz, “Stability of journal bearing system with piezoelectric elements,” *Mach. Dyn. Probl.*, vol. 24, no. 1, pp. 155–171, 2000.
- [4] T. Szolc, K. Falkowski, M. Henzel, and P. Kurnyta-Mazurek, “Determination of parameters for a design of the stable electro-dynamic passive magnetic support of a high-speed flexible rotor,” *Bull. Pol. Acad. Sci. Tech. Sci.*, vol. 67, no. 1, pp. 91–105, 2019.
- [5] H. Urreta, Z. Leicht, A. Sanchez, A. Agirre, P. Kuzhir, and G. Magnac, “Hydrodynamic Bearing Lubricated with Magnetic Fluids,” *J. Intell. Mater. Syst. Struct.*, vol. 21, 2010.
- [6] X. Wang, H. Li, M. Li, H. Bai, G. Meng, and H. Zhang, “Dynamic characteristics of magnetorheological fluid lubricated journal bearing and its application to rotor vibration control,” *J. Vibroeng.*, vol. 17, pp. 1912–1927, 2015.
- [7] J. Zapoměl and P. Ferfecki, “The influence of ferromagnetic fluids on performance of hydrodynamic bearings,” *Vibroeng. Procedia*, vol. 27, pp. 133–138, 2019.
- [8] J. Zapoměl and P. Ferfecki, “Study of the load capacity and vibration stability of rotors supported by hydrodynamic bearings lubricated by magnetically sensitive oil,” in *Proc. of the 14th International Conference on Dynamics of Rotating Machines*, 2021, pp. 1–9.
- [9] D. Susan-Resiga and L. Vékás, “From high magnetization ferrofluids to nano-micro composite magnetorheological fluid: properties and applications,” *Rom. Rep. Phys.*, vol. 70, pp. 1–29, 2018.
- [10] N. Ida. *Engineering Electromagnetics*. Heidelberg: Springer, 2015.
- [11] P. Ferfecki, J. Zapoměl, and J. Kozánek, “Analysis of the vibration attenuation of rotors supported by magnetorheological squeeze film dampers as a multiphysical finite element problem,” *Adv. Eng. Software*, vol. 104, pp. 1–11, 2017.
- [12] J. Zapoměl. *Computer Modelling of Lateral Vibration of Rotors Supported by Hydrodynamical Bearings and Squeeze Film Damper*. Ostrava: VSB-Technical University of Ostrava, 2007. [in Czech]
- [13] E. Krämer. *Dynamics of Rotors and Foundations*. Berlin, Heidelberg: Springer-Verlag, 1993.