

SELECTED ASPECTS OF MOTOR VEHICLE DYNAMICS ON THE EXAMPLE OF A POWER-OFF STRAIGHT LINE MANEUVER

Jerzy KISIŁOWSKI¹, Jarosław ZALEWSKI²

¹ Kazimierz Pułaski University of Technology and Humanities, Faculty of Transport and Electrical Engineering, Radom, Poland

² Warsaw University of Technology, Faculty of Administration and Social Sciences, Warsaw, Poland

Abstract:

In this paper the selected phenomena related to motor vehicle's motion have been considered basing on a computer simulation. The vehicle performed a power-off straight line maneuver with different road conditions being included.

All simulations have been performed in the MSC Adams/Car environment based on the available sports two-seater vehicle model, realizing the adopted maneuver at the instant speed of 100km/h. This enabled observation of the selected phenomena along the road long enough to relate them to different aspects of vehicle dynamics research.

As for the randomly uneven road, almost similar and almost different profiles have been assumed for the left and right wheels of the vehicle. Additionally, two values of the coefficient determining the maximum amplitude of road irregularities have been selected: 0.3 for lower and 0.9 for higher irregularities, so the road surface conditions along with the flat road have been considered as one of the factors causing disturbances of the motor vehicle motion.

Such research seems valuable from the point of view of road traffic safety and vehicle maintenance. This specific example is a presentation of the possible research on vehicle dynamics as well as a potential background for further considerations including different types of vehicles along with almost different road profiles for the left and right wheels of the given vehicle model.

A power-off straight maneuver is not performed very often in normal road traffic. However, such test could be valuable when analyzing influence of the selected motor vehicle parameters, such as uneven loading, suspension characteristics, etc. on such maintenance features as stability, steerability and the influence of external disturbances acting on the moving vehicle. Further research provides different maneuvers and different simulation conditions.

Keywords: motor vehicle dynamics, power-off, straightforward motion

To cite this article:

Kisilowski, J., Zalewski, J., 2019. Selected aspects of motor vehicle dynamics on the example of a power-off straight line maneuver. *Archives of Transport*, 50(2), 57-76.
DOI: <https://doi.org/10.5604/01.3001.0013.5647>



Contact:

1) jkisilow@kisilowscy.waw.pl [<https://orcid.org/0000-0003-3747-0578>], 2) j.zalewski@ans.pw.edu.pl [<https://orcid.org/0000-0002-7559-0119>]

1. Introduction

The aim of this paper is to present the selected aspects of motor vehicle dynamics based on simulation of a motor vehicle motion. As for the adopted maneuver different road conditions have been considered along with the selected parameters and vehicle loading configurations for the purpose of an exemplary analysis of a motor vehicle in the specific road conditions with the power-off straightforward maneuver.

The straightforward motion with the power-off has been selected because it seems obvious that in such conditions the vehicle response to the occurring disturbances would provide interesting results, especially in case of the necessity to control the vehicle direction of travel by a driver. A double seater vehicle used here has also been the subject of analyses in previous papers, e.g. (Kisilowski, 2016), (Kisilowski, 2018) and (Zalewski, 2018). In these works, it has however been laden differently as presented in the assumptions section. Also, in (Zalewski, 2018) attention has been paid to the influence of randomly uneven roads on the motor vehicle moving at the constant speed and only with almost similar road profiles for the left and right wheels of the vehicle. This included the normal reaction forces acting on the wheels, which is directly related to the vehicle loading and the forces transferred from the wheels via suspension to the vehicle body, which has previously been the subject of multiple works, such as (Ślaski, 2011) where the exemplary tests of the wheel loading have been conducted with the change in suspension damping.

Another problem typical in road traffic, especially in trucks and lorries, is related to vehicle overweight. The excessive load can cause accident situations, maintenance problems and road damage. Such considerations have been presented in (Mitas, 2012) where the idea of a pre-selection measurement system of the selected vehicle parameters, including the vehicle weight measured in motion, have been considered.

Part of research on the road traffic safety is related to road intersections and roundabouts. In (Macioszek, 2015) some specific attempt towards safety at so called 'turbo roundabouts' has been presented, which seems important, because the roundabouts play a crucial part in stabilizing the motion of motor vehicles as a stream along the intersecting roads.

Certain aspects of longitudinal motion of a motor vehicle has been previously considered in many works, e.g. in (Mastinu, 2014) and (Rill, 2011) while the selected aspects of lateral motion, e.g. in (Ni, 2016). However, no work has been found comparing the motion on different road conditions with the power-off maneuver adopted.

As for the random road irregularities, several works have been devoted to the problem of road quality classification, e.g. (Múčka, 2016). Another issue is using the uneven road surface for simulations which has been the subject of, e.g. (Shao, 2019) and (Shi, 2019), especially in the matter of road conditions.

Another scope of issues has recently been related to vehicle steering, which includes results presented in such papers as, e.g. (Best, 2019), (Ni, 2016) and (Shao, 2019). They relate to motor vehicle safety and ability to perform maneuvers allowing avoidance of dangerous situations on the road at the same time.

Considering the works discussed above one can notice that the scope of research on vehicle dynamics is very broad and including all the problems in one paper is not possible. In relation to this observation the author have proposed the main aim of this paper, which is to present the possibility of assessing the motor vehicle motion on the basis of computer simulations and answering the question whether the road conditions may have an impact on the vehicle performance, especially if the road surface conditions (uneven, etc.) would be combined with weather conditions (dry, icy, etc.).

The presented paper is only an example of the variety of different combinations reflecting road conditions. The selected power off straight line maneuver with the driver's interference shall provide the answer if the simulated vehicle will respond to the external disturbances, in this case random irregularities of the road. However, the presented considerations may be a part of road traffic safety research in a broader sense. For example, not including the straight-line control could enable comparison showing to what extent the vehicle would deviate from the straight line and could be helpful with analysing if it would be difficult for the driver to maintain the straight-line course for such disturbances.

2. Assumptions for the simulations

The vehicle model (fig. 1) has been laden with both a driver ($m_1 = 90$ kg) and a passenger ($m_2 = 54$ kg)

with the additional mass of a baggage ($m_B = 14$ kg) which has been located in front part of the vehicle (under the bonnet) because both the engine and the drive system are located in the back of the given vehicle.

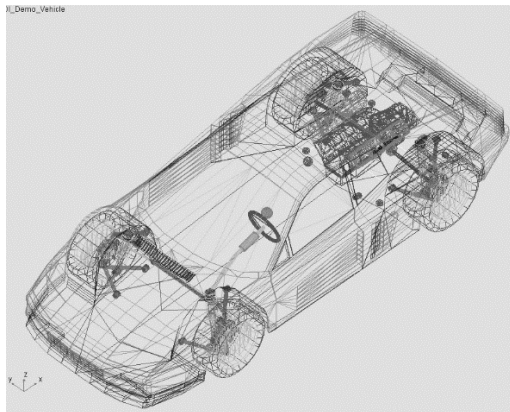

Fig. 1. The sports two-seater used in the simulations [MSC Adams/Car]

Table 1. Mass – inertia parameters of the unladen simulated vehicle model

	vehicle body	whole vehicle
mass	995 kg	1528 kg
center of mass location relative to the 'origo' point	$x_c=1,5$ m, $y_c=0$, $z_c=0,45$ m	$x_c=1,75$ m, $y_c=-0,0014$ m, $z_c=0,43$ m
moment of inertia (I_x) relative to the x axis passing through 'origo'	401 kg·m ²	583 kg·m ²
moment of inertia (I_y) relative to the y axis passing through 'origo'	2940 kg·m ²	6129 kg·m ²
moment of inertia (I_z) relative to the z axis passing through 'origo'	2838 kg·m ²	6022 kg·m ²
moment of deviation (I_{xy}) relative to the axes x and y passing through 'origo'	0	-1,9 kg·m ²
moment of deviation (I_{xz}) relative to the axes x and z passing through 'origo'	671 kg·m ²	1160 kg·m ²
moment of deviation (I_{yz}) relative to the axes y and z passing through 'origo'	0	-1,3 kg·m ²

In order to provide valuable results of the simulations both mass and inertia parameters of the vehicle body have been changed, thanks to which the additional load has been included. This also changed the distribution of mass in the whole vehicle. In table 1 coordinated of the center of mass and moments of inertia and deviation before loading have been presented relative to the 'origo' point, which has been characterized e.g. in (Kisilowski, 2016). It is an origin of a coordinate system which is located on the road surface but moves along with the vehicle (fig. 2 and 3).

In table 2 the same parameters in case of the laden vehicle body have been presented. It is worth noticing that the main changes related to the moments of inertia, both in case of the vehicle body and the whole vehicle. As for the moments of deviation there has not been a significant change, because the baggage, however located in front of the vehicle and dislocated versus the longitudinal symmetry plane, had only a 14 kg mass. Therefore, it did not affect the spread mass enough to significantly increase the moments of deviation. The aim of vehicle loading is to present the simulation results more relevant when reflecting the real situation in motor vehicle dynamics research.

The roundabout aspect of vehicle motion, as in (Macioszek, 2015), cannot be considered in the presented case because the main goal here was to present the vehicle's response to the external disturbances at the speed which is in general higher than that for the entering or exiting a roundabout.

As for the adopted maneuver, in table 3 each configuration concerning mainly the road conditions has been presented. It is necessary to mention that the aerodynamic forces acting as motion resistances have been neglected as it has been assumed that the maneuver is realised in normal conditions without strong wind that may disturb the desired course of a vehicle.

It is also necessary to mention that all of the presented results concern the simulation with controlling the straightforward motion during the power-off maneuver which has been presented in fig. 4. Hence one of the aims of this paper is to present the possible consequences of the selected disturbances of motion as an additional work that a driver has to perform in order to control the vehicle direction. The random nature of road irregularities has been widely used in similar analyses and

corresponds to such papers as (Múčka, 2016), (Shao, 2019) and (Shi, 2019) which are related to both classification and using random profiles of the road surface in simulations of motor vehicle performing different maneuvers. It has previously been considered by the authors of this paper as well, e.g. (Kisilowski, 2016), (Kisilowski, 2018) and (Zalewski, 2018).

However in the future the authors would like to perform a set of analyses providing the answer to the question about the vehicle behaviour when a driver does not take any action to control the direction of vehicle motion, but only an option of a straight line control by the vehicle has been used.

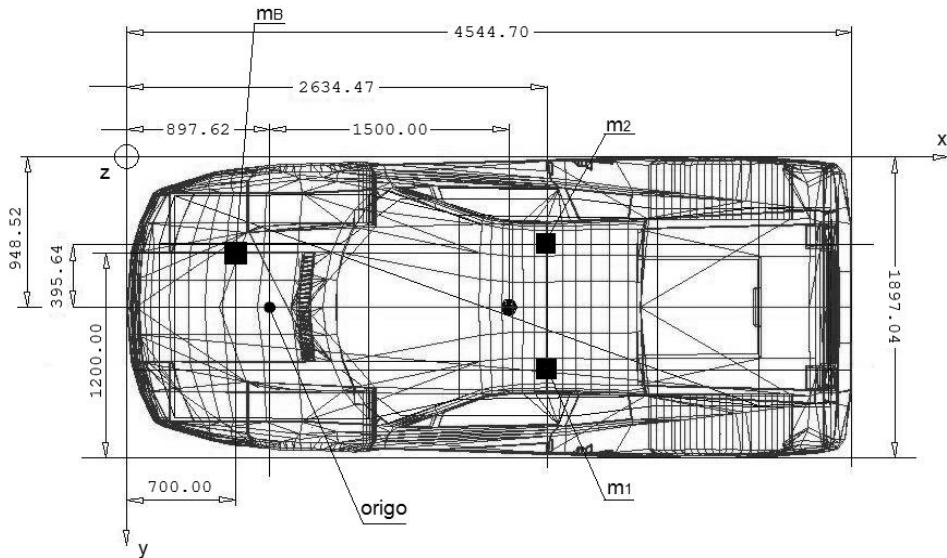

Fig. 2. Location of the masses loading the vehicle body along with the 'origo' point – plan view (Zalewski, 2018)

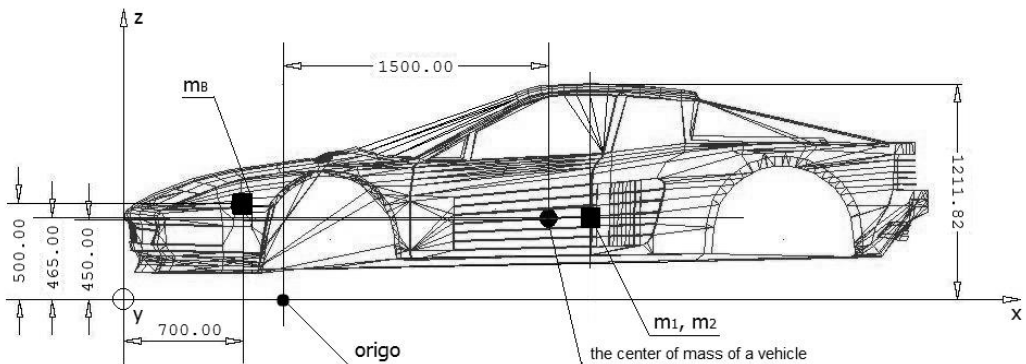

Fig. 3. Location of the masses loading the vehicle body along with the 'origo' point – left side view (Zalewski, 2018)

Table 2. Mass – inertia parameters of the laden simulated vehicle model

	vehicle body	whole vehicle
mass	1153 kg	1686 kg
center of mass location relative to the 'origo' point	$x_c=1,508$ m, $y_c=0,0012$ m, $z_c=0,452$ m	$x_c=1,73$ m, $y_c=-0,0004$ m, $z_c=0,434$ m
moment of inertia (I_x) relative to the x axis passing through 'origo'	435 kg·m ²	617 kg·m ²
moment of inertia (I_y) relative to the y axis passing through 'origo'	3357 kg·m ²	6546 kg·m ²
moment of inertia (I_z) relative to the z axis passing through 'origo'	3221 kg·m ²	6405 kg·m ²
moment of deviation (I_{xy}) relative to the axes x and y passing through 'origo'	2,08 kg·m ²	0,17 kg·m ²
moment of deviation (I_{xz}) relative to the axes x and z passing through 'origo'	785 kg·m ²	1275 kg·m ²
moment of deviation (I_{yz}) relative to the axes y and z passing through 'origo'	0,62 kg·m ²	-0,67 kg·m ²

Table 3. Configurations adopted for the power-off maneuver simulation

	road surface	road type	profile similarity
configuration 1	dry ($\mu = 0.8$)	flat	-
configuration 2	icy ($\mu = 0.3$)	flat	-
configuration 3	dry ($\mu = 0.8$)	uneven (intensity 0.3)	0.8
configuration 4	icy ($\mu = 0.3$)	uneven (intensity 0.3)	0.8
configuration 5	dry ($\mu = 0.8$)	uneven (intensity 0.9)	0.8
configuration 6	icy ($\mu = 0.3$)	uneven (intensity 0.9)	0.8
configuration 7	dry ($\mu = 0.8$)	uneven (intensity 0.3)	0.2
configuration 8	icy ($\mu = 0.3$)	uneven (intensity 0.3)	0.2
configuration 9	dry ($\mu = 0.8$)	uneven (intensity 0.9)	0.2
configuration 10	icy ($\mu = 0.3$)	uneven (intensity 0.9)	0.2

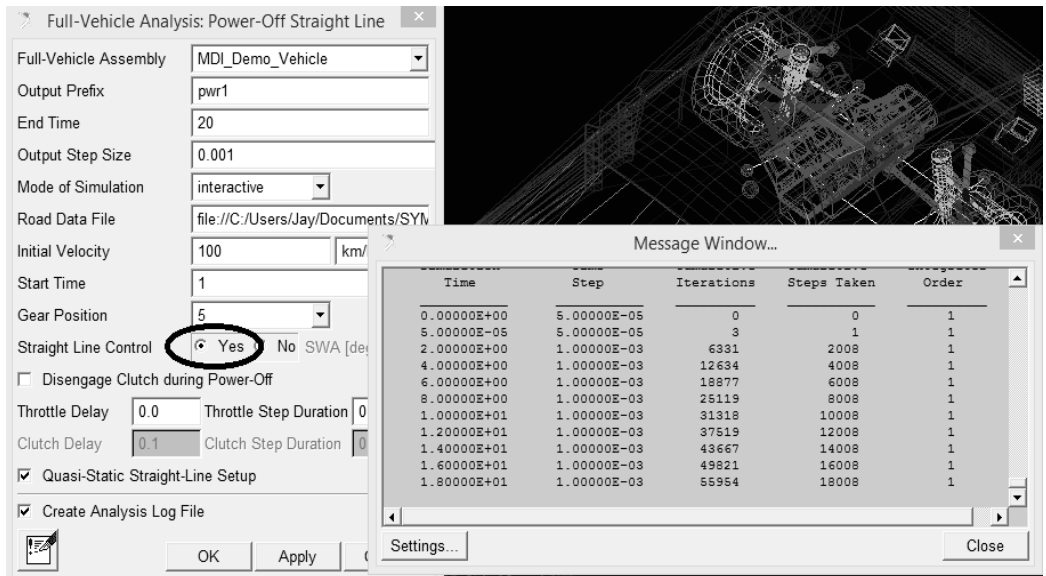

Fig. 4. Running all the adopted simulations with the straight-line control by the driver [MSC Adams/Car]

3. Discussion on the selected results

When concerning the behaviour of a vehicle in different road conditions usually different factors and indicators can be used to assess the vehicle response to e.g. external disturbances or different, changing traffic conditions, while performing various maneuvers. Some aspects have not been considered, such as wheel – road contact phenomena, because they have previously been analysed in multiple works, e.g. in (Ślaski, 2011). Moreover, the authors were more interested in the response of the vehicle, not analysing its separate subsystems. But the selected aspects of both longitudinal and lateral motion, discussed previously in such works as (Mastinu, 2014), (Rill, 2011) and (Ni, 2016) had been included as the behavior of a motor vehicle under different road conditions.

In this paper the driver's model has not been included the same as no maneuver showing e.g. the sudden change in direction of motion in order to omit the road obstacle which, for example in (Best, 2019), (Ni, 2016) and (Shao, 2019) was used as a scope of discussion on the road safety and dangerous situations in road traffic.

Despite the power-off straight line maneuver the authors paid attention to the potential phenomena related to lateral motion which can indicate deviation from the original, straight line. Another question is whether the uneven spread of mass in the

simulated vehicle can cause lateral phenomena even if the straight line motion is requested.

In fig. 5 a set of trajectories for the first two configurations from table 3 have been presented, i.e. for the motion on a flat road surface. As it can be seen no significant differences in those two courses have been observed as in both cases the motion has been performed on the flat road surface, so only a minor displacement on the icy road versus the dry road can be observed for the distance between about 50th and 440th meter, as the whole maneuver took place on the part of the road shorter than 450 meters. More interesting, but only in the aspect of the shape of the obtained trajectories, seem to be the examples presented in figs. 6, 7, 8 and 9. Although these results need some discussion there is no doubt that in general the option of controlling the straight line course does not allow to fully examine the vehicle response to the given random disturbances coming from the road. However, for the courses presented in figs. 6 – 9 it is clearly noticeable that the random road irregularities can cause disturbances even in the straightforward motion controlled by the driver, because the shape of each trajectory obtained in these figures is not smooth as in fig. 5, but jagged as if the vehicle had greater difficulties maintaining the adopted direction of motion.

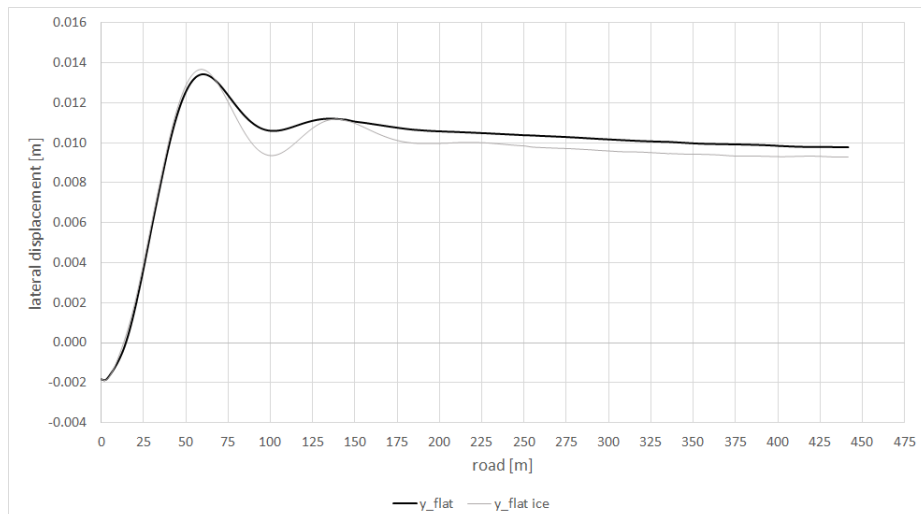

Fig. 5. Trajectories on a dry and icy flat road surface

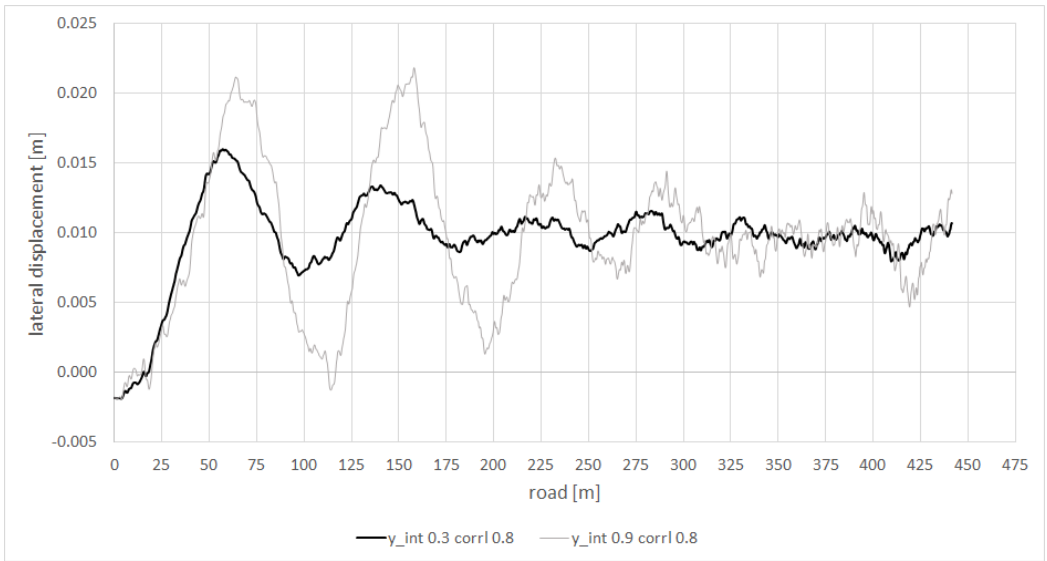

Fig. 6. Trajectories on a dry, randomly uneven road surface with the almost similar left and right profiles of irregularities as well as different amplitudes of these irregularities

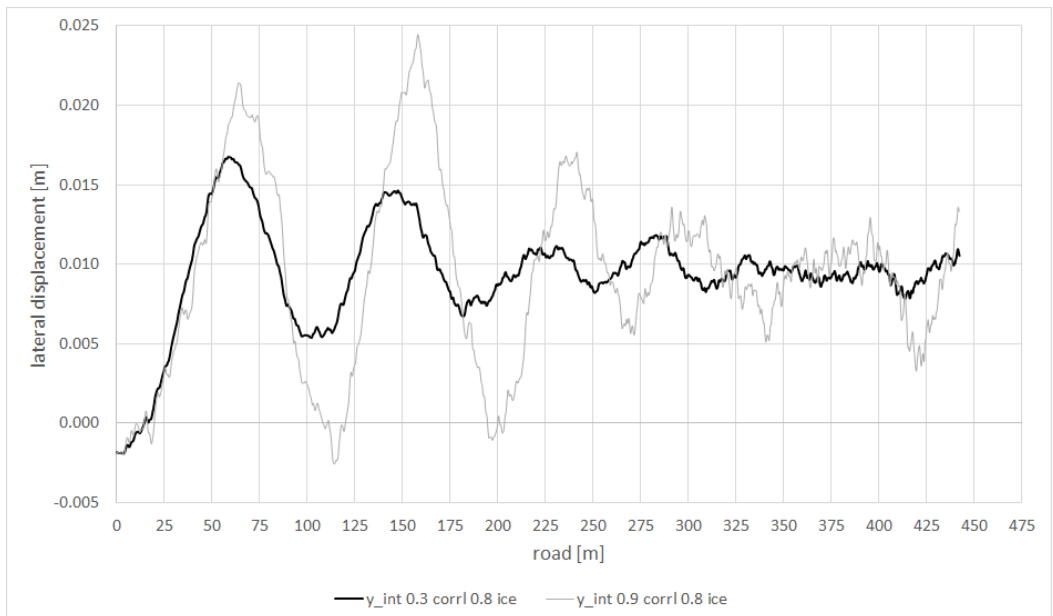

Fig. 7. Trajectories on an icy, randomly uneven road surface with the almost similar left and right profiles of irregularities as well as different amplitudes of these irregularities

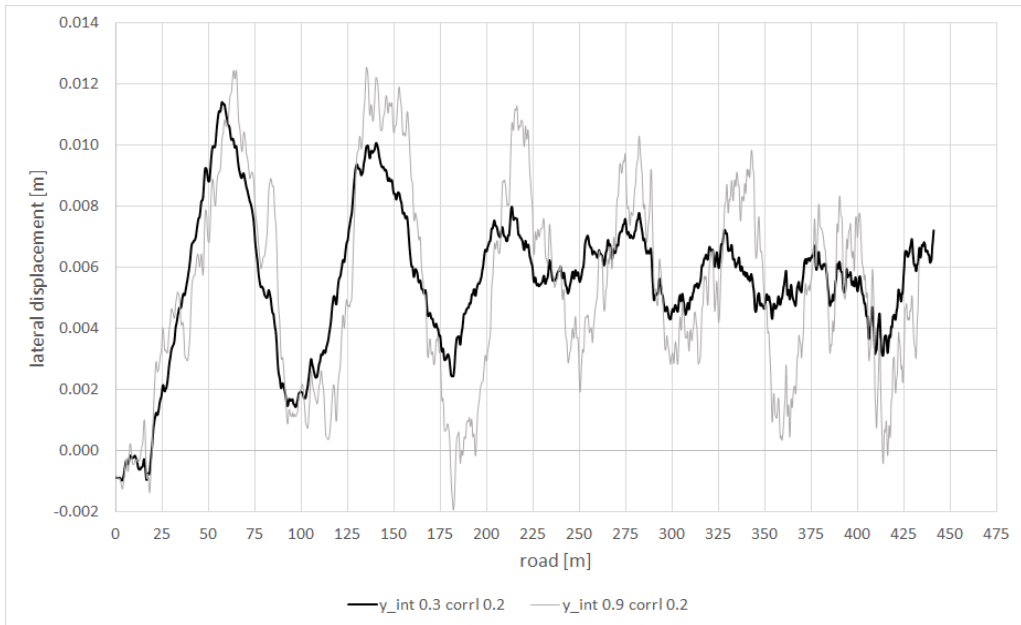

Fig. 8. Trajectories on a dry, randomly uneven road surface with the almost different left and right profiles of irregularities as well as different amplitudes of these irregularities

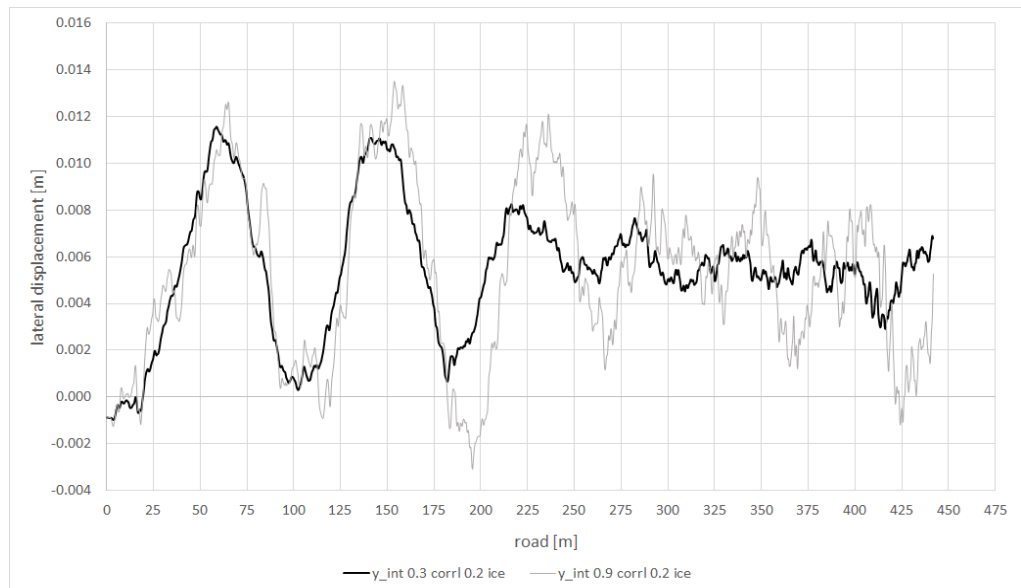

Fig. 9. Trajectories on an icy, randomly uneven road surface with the almost different left and right profiles of irregularities as well as different amplitudes of these irregularities

In each case, even for road irregularities with greater amplitudes (intensity 0.9), the lateral displacement versus the covered distance had little values (up to 2.5 cm for the motion with almost similar road profiles for right and left wheels – figs. 6 and 7) which could not affect the realised maneuver. These figures show that the random irregularities and uneven mass spread in a vehicle can cause only the necessity for greater concentration and control by a driver.

Another, maybe more interesting issue discussed here, can be if there is a possibility of lateral phenomena during the potentially straightforward motion of the vehicle.

As the lateral displacement proved to be marginal, yet involving driver reaction especially in case of randomly uneven road surface, it is worth paying attention to the lateral velocities as a factor that may cause the potential danger in road traffic safety.

In figs. 10 – 14 the lateral velocity of the simulated vehicle for each configuration has been presented. For the motion on a flat road (fig. 10) the maximum value of lateral velocity reached as much as 0.012

$\text{m}\cdot\text{s}^{-1}$ whereas, regardless the icy or dry road, the random irregularities caused the increase in the velocity to $0.065 \text{ m}\cdot\text{s}^{-1}$ which can seem marginal, but shows the influence of road conditions on the potential disturbances in the vehicle motion. It is necessary of mention that the straight line control has been adopted in the given maneuvers.

All of the presented changes in the lateral velocity have shown a similar tendency to stabilize around a 0 value which proves that the straight line course has been adopted and that the driver, in case of moving on a randomly uneven road, would have to correct the direction of motion at all times.

As for the lateral motion, another factor which seems worth consideration is the lateral acceleration. In figs. 15 – 19 the changes in lateral component of vehicle acceleration have been presented. From the fig. 15 it is clearly seen that the value of lateral acceleration is marginally low (up to $0.05 \text{ m}\cdot\text{s}^{-2}$), either on dry or icy surface. However, as presented in figs. 16 – 19 the value of this parameter was significantly higher in all other cases of vehicle motion.

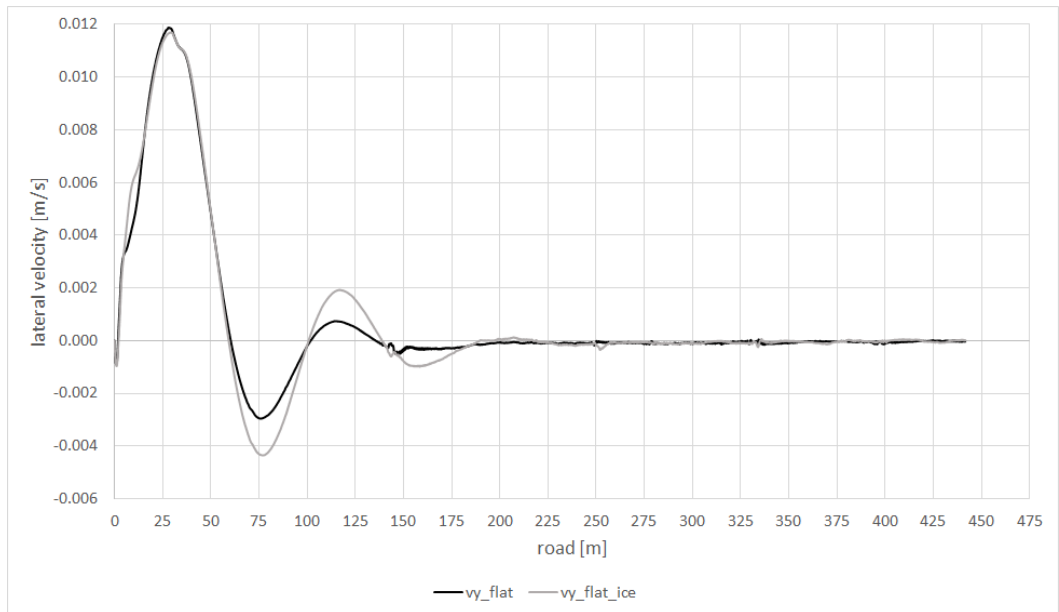

Fig. 10. Lateral velocity on a dry and icy, flat road surface

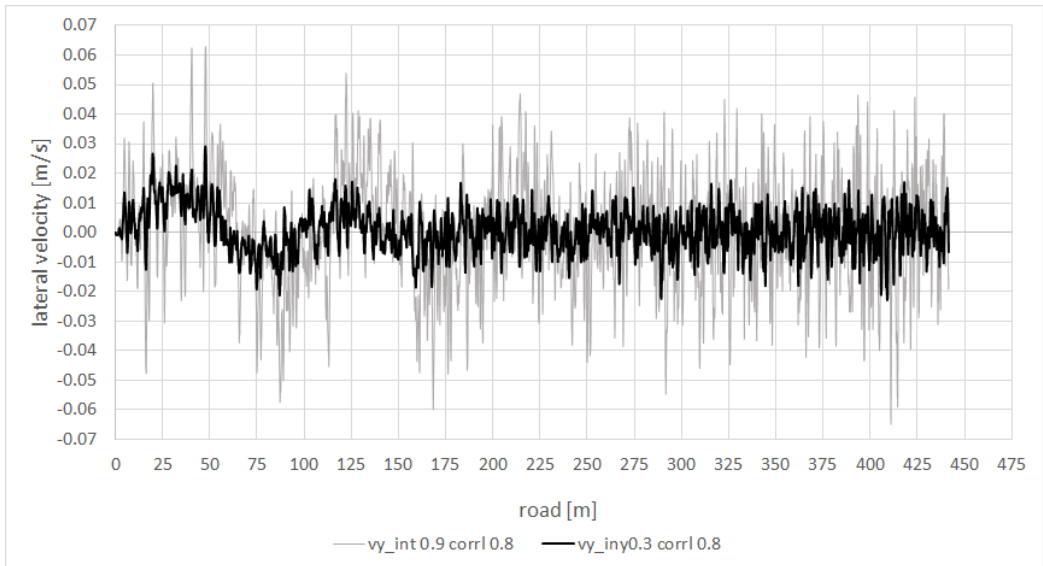

Fig. 11. Lateral velocity on a dry, randomly uneven road surface with the almost similar left and right profiles of irregularities as well as different amplitudes of these irregularities

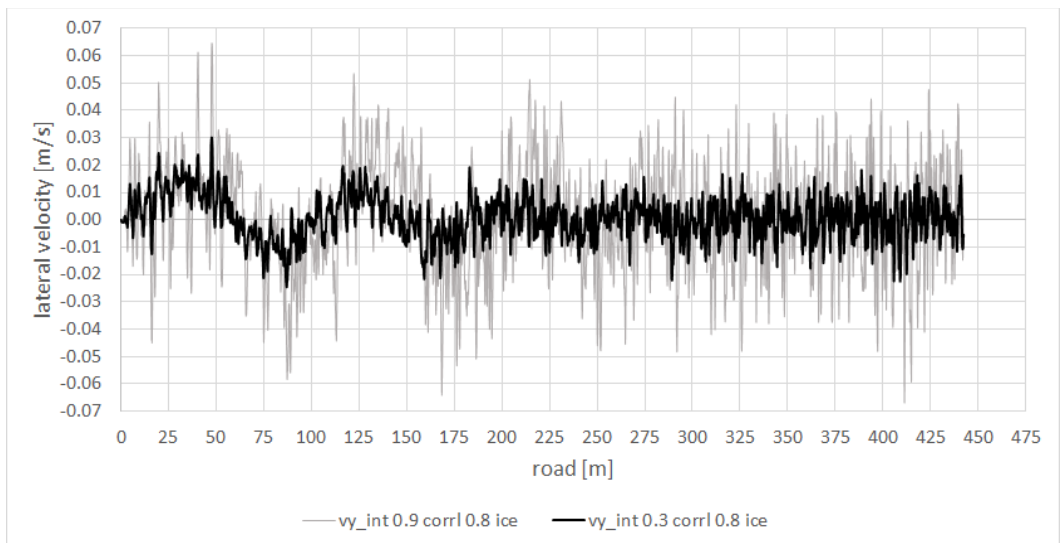

Fig. 12. Lateral velocity on an icy, randomly uneven road surface with the almost similar left and right profiles of irregularities as well as different amplitudes of these irregularities

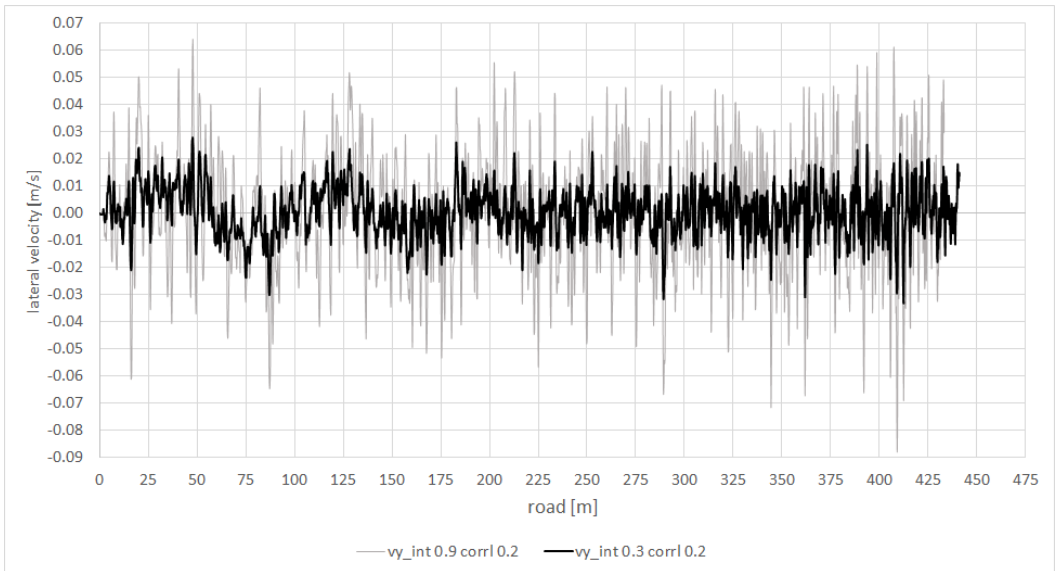

Fig. 13. Lateral velocity on a dry, randomly uneven road surface with the almost different left and right profiles of irregularities as well as different amplitudes of these irregularities

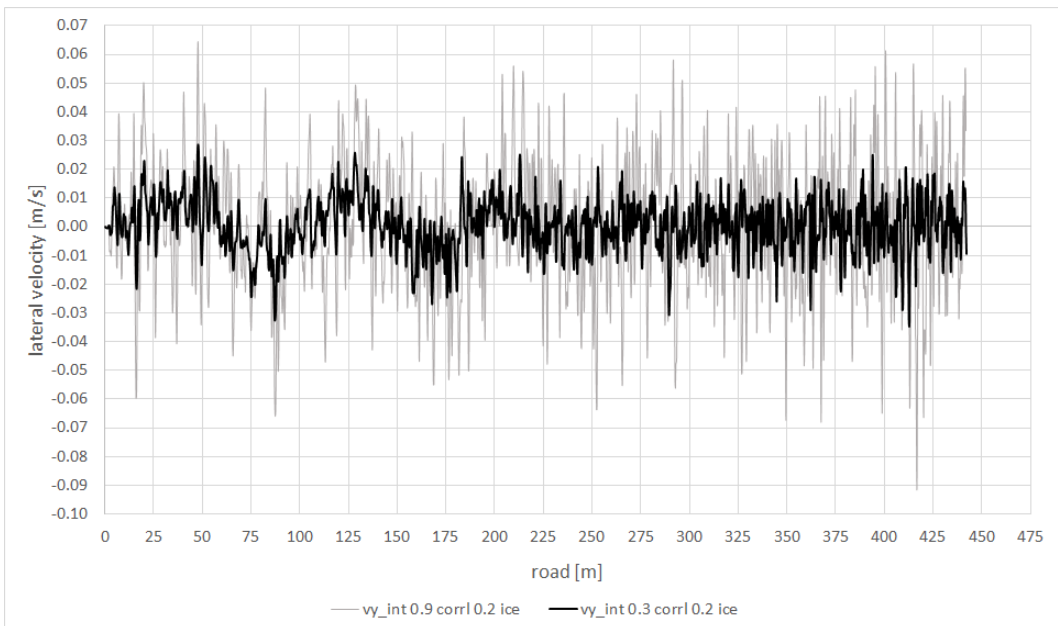

Fig. 14. Lateral velocity on an icy, randomly uneven road surface with the almost different left and right profiles of irregularities as well as different amplitudes of these irregularities

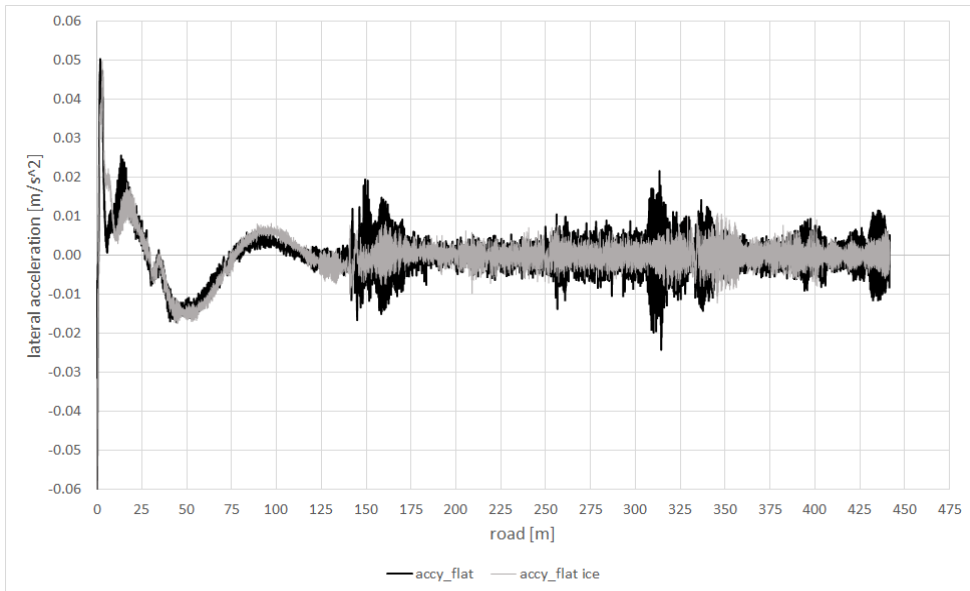

Fig. 15. Lateral acceleration for the motion on a dry and icy flat road surface

On both dry and icy road surface, for almost similar road profiles for left and right wheels the maximum absolute values of the lateral acceleration reached up to nearly $2 \text{ m}\cdot\text{s}^{-2}$ for lower irregularities (intensity 0.3) and up to $4.5 \text{ m}\cdot\text{s}^{-2}$ for higher irregularities (intensity 0.9). This means that the icy road conditions had no influence on the lateral phenomena in a straightforward motion when the straight line has been controlled but the amplitudes of road irregularities played an important role as a factor generating additional acceleration in the lateral direction.

As for the almost different road profiles for the left and right wheels it seems that the tendency is similar to described above, however the absolute maximum values of lateral acceleration for lower irregularities amounted to $2.5 \text{ m}\cdot\text{s}^{-2}$ in case of the dry road surface and to $5 \text{ m}\cdot\text{s}^{-2}$ in case of both dry and icy road for higher irregularities. This means that in case of different road profiles for left and right wheels the driver could expect different behaviour depending on the height of irregularities and road surface conditions as the chart in fig. 18 differs from that in fig. 19.

One of the main parameter often used as an indicator allowing the general assessment of ride comfort in the vertical accelerations of a vehicle, because it directly

affects the driver and passengers. In figs. 20 – 24 the course of vertical acceleration versus the covered distance for all configurations from table 3 has been presented. The main issue proved by these figures is that random irregularities provide additional, unnecessary vertical acceleration exceeding its absolute value from almost $2.25 \text{ m}\cdot\text{s}^{-2}$ for the flat road to as much as almost $6 \text{ m}\cdot\text{s}^{-2}$ for the random road profile similar for left and right wheels and around $7 \text{ m}\cdot\text{s}^{-2}$ for the road where the profiles of left and right wheels remained almost different.

It is necessary to say that this problem is not widely considered here as it has been the subject of some of the authors' previous works and it does not correspond with the lateral phenomena discussed in this paper.

The last problem discussed for the purpose of this paper has been the changes in angular velocity around the vertical axis passing through the vehicle center of mass. In fig. 25 these changes have been presented for the motion on either dry or icy, but flat road surface. The changes have not been significant (maximum around $0.09 \text{ deg}\cdot\text{s}^{-1}$ in absolute value) and the vehicle did not tend to change its direction by a sudden change of the angular velocity which seems the adequate parameter for examination of a vehicle motion along a road plane.

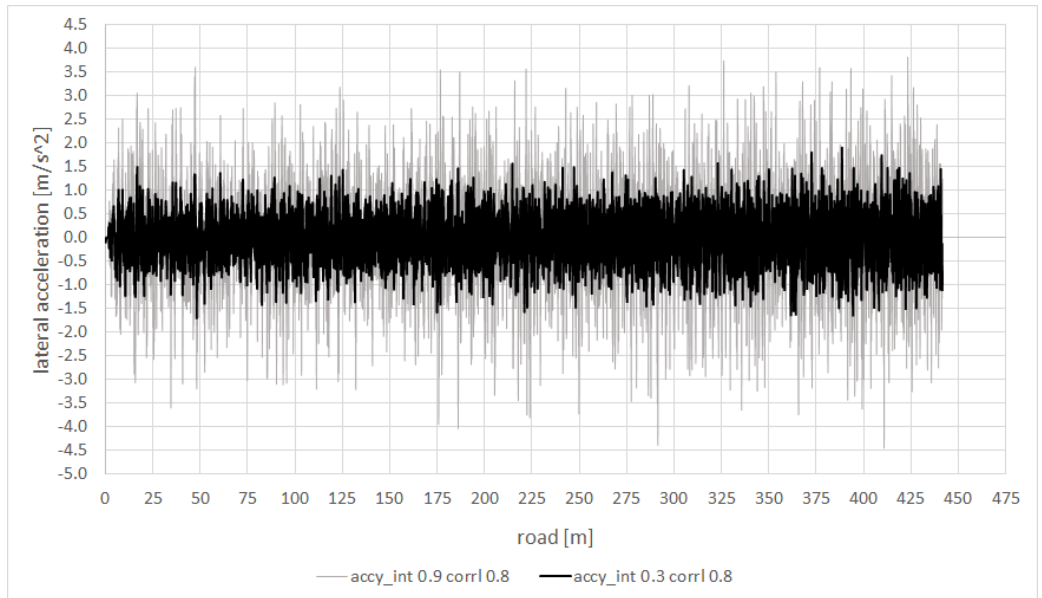

Fig. 16. Lateral acceleration on a dry, randomly uneven road surface with the almost similar left and right profiles of irregularities as well as different amplitudes of these irregularities

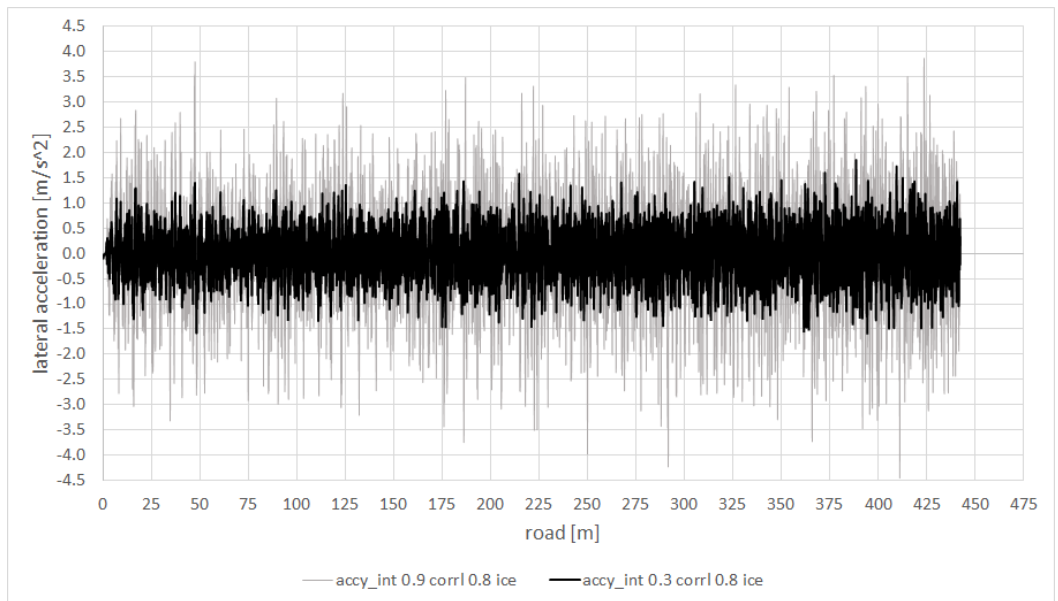

Fig. 17. Lateral acceleration on an icy, randomly uneven road surface with the almost similar left and right profiles of irregularities as well as different amplitudes of these irregularities

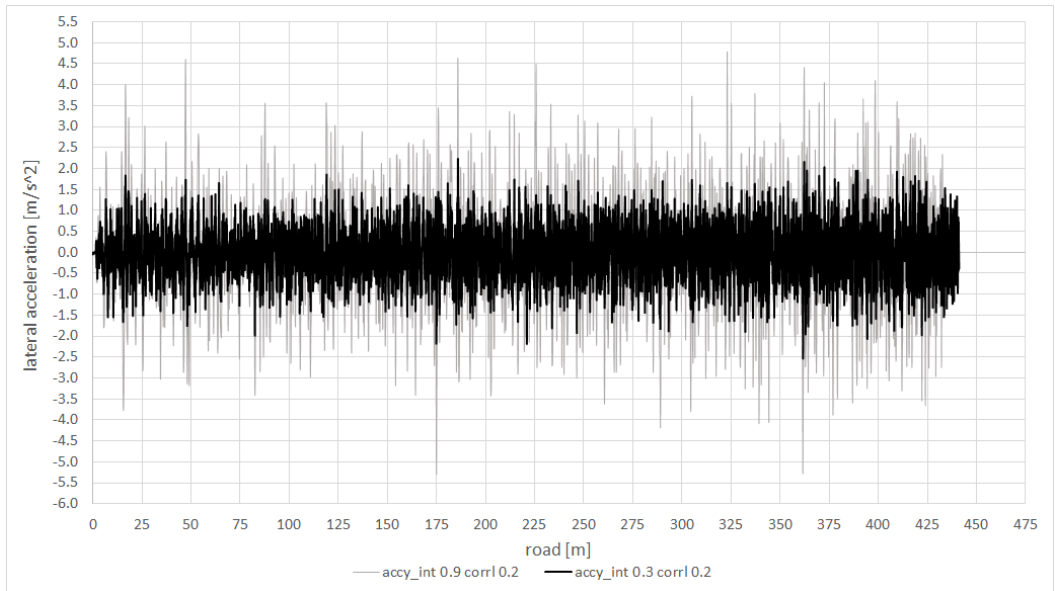

Fig. 18. Lateral acceleration on a dry, randomly uneven road surface with the almost different left and right profiles of irregularities as well as different amplitudes of these irregularities

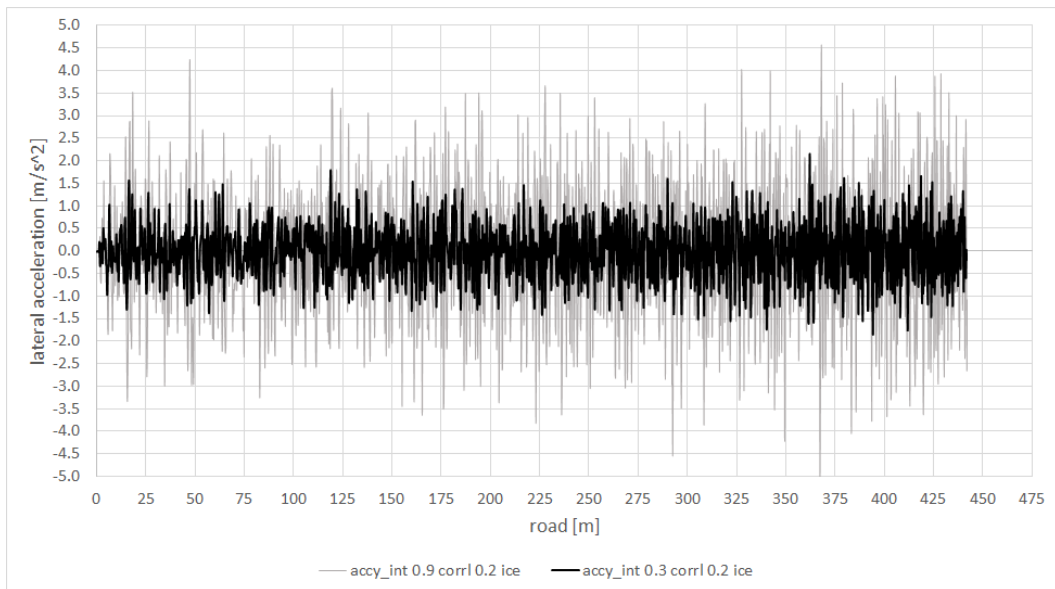

Fig. 19. Lateral acceleration on an icy, randomly uneven road surface with the almost different left and right profiles of irregularities as well as different amplitudes of these irregularities

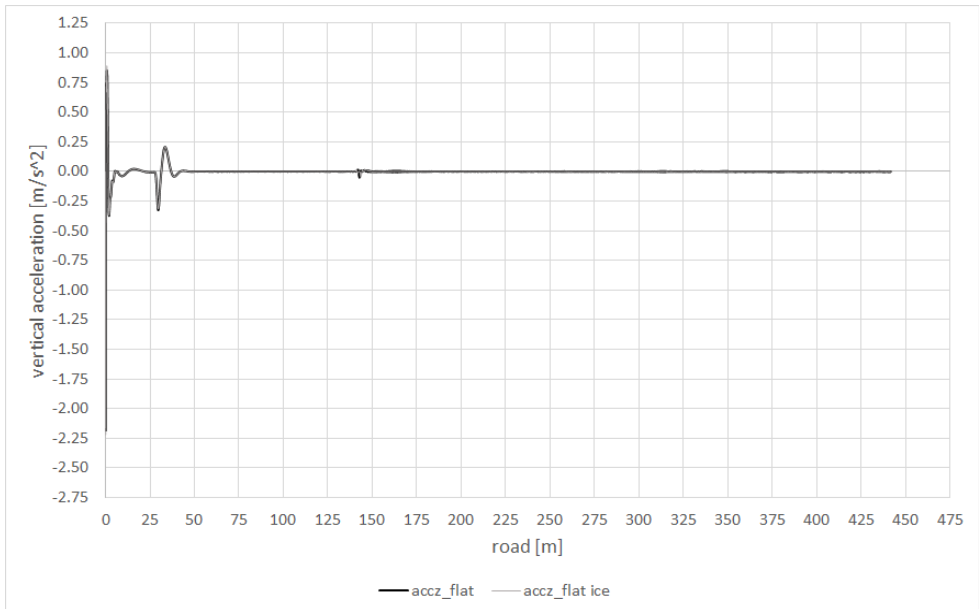

Fig. 20. Vertical acceleration for the motion on a dry and icy flat road

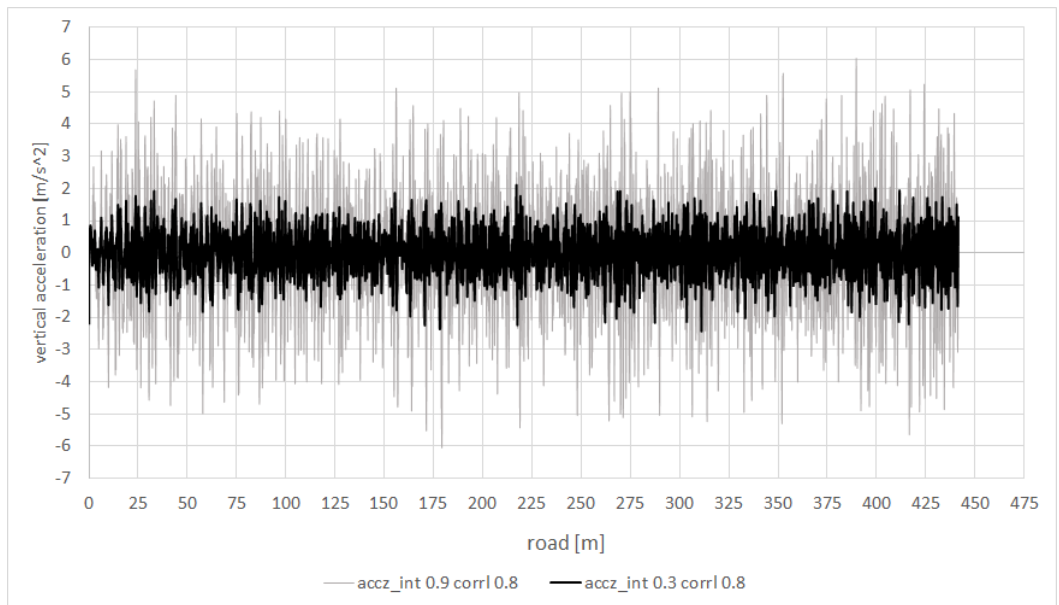

Fig. 21. Vertical acceleration on a dry, randomly uneven road surface with the almost similar left and right profiles of irregularities as well as different amplitudes of these irregularities

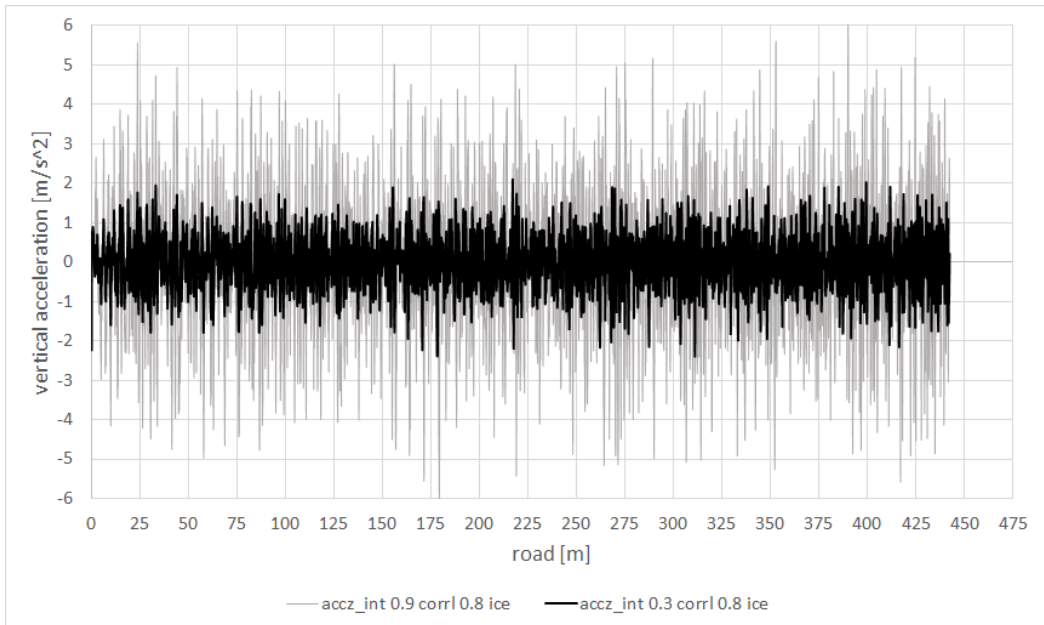

Fig. 22. Vertical acceleration on an icy, randomly uneven road surface with the almost similar left and right profiles of irregularities as well as different amplitudes of these irregularities

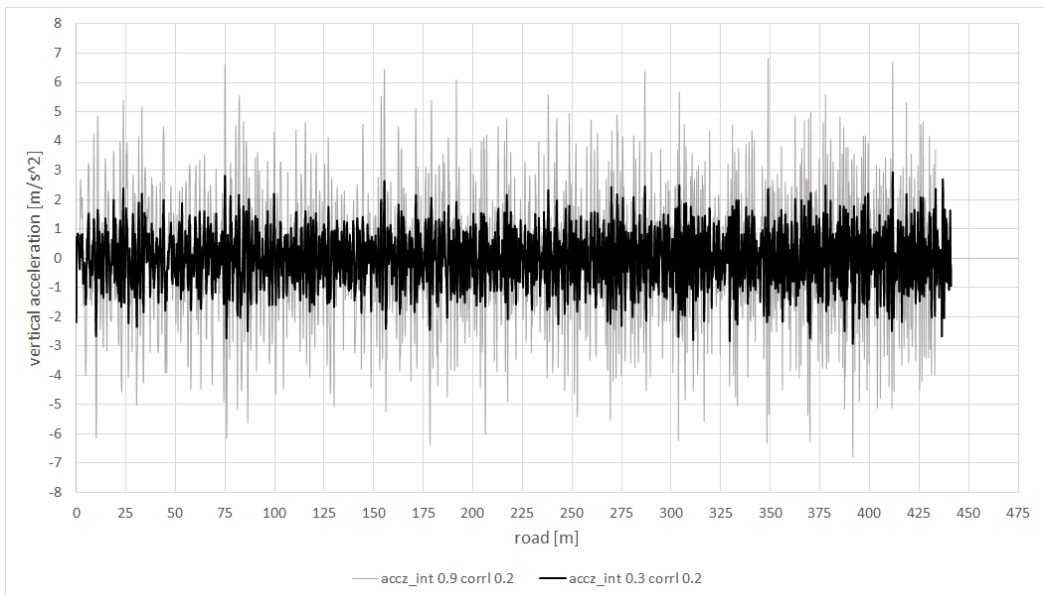

Fig. 23. Vertical acceleration on a dry, randomly uneven road surface with the almost different left and right profiles of irregularities as well as different amplitudes of these irregularities

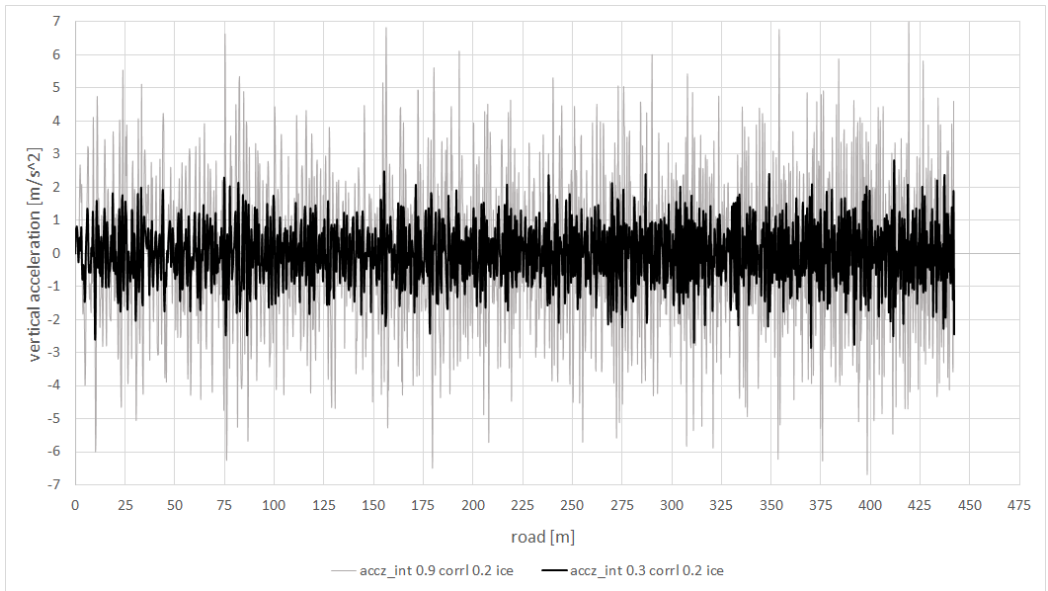

Fig. 24. Vertical acceleration on an icy, randomly uneven road surface with the almost different left and right profiles of irregularities as well as different amplitudes of these irregularities

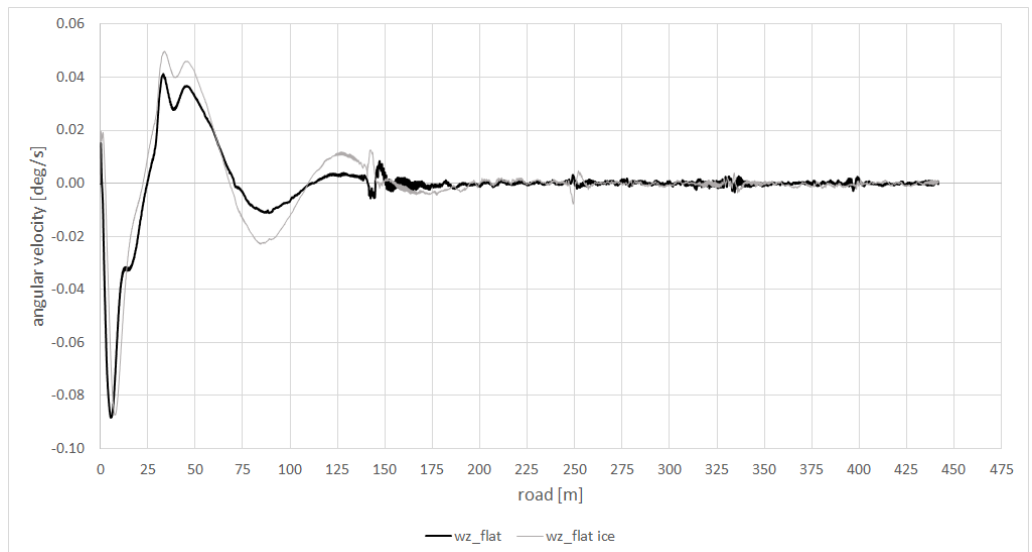

Fig. 25. Angular velocity around the vertical axis for the motion on a dry and icy flat road

As for the changes in the angular velocity on a randomly uneven road it can be seen that, first of all, the irregularities in the road surface may cause the vehicle to rotate more rapid than on a flat road as the

maximum value of the angular velocity for each of the remaining configurations (figs. 26 – 29) amounted to around $1 \text{ deg}\cdot\text{s}^{-1}$. Second, it can be seen that the changes of this parameter has been more

rapis and did not stabilize as in fig. 25. However the mean value of this velocity remained at 0 for each of the discussed configurations (table 3), it is important to bear in mind that the changes in angular velocity occurred more rapidly for the motion along the

uneven road and the straight line control has been provided for each of the discussed example of motion. Moreover for the motion on an icy road surface these changes seem more turbulent than for the dry, yet randomly uneven road.

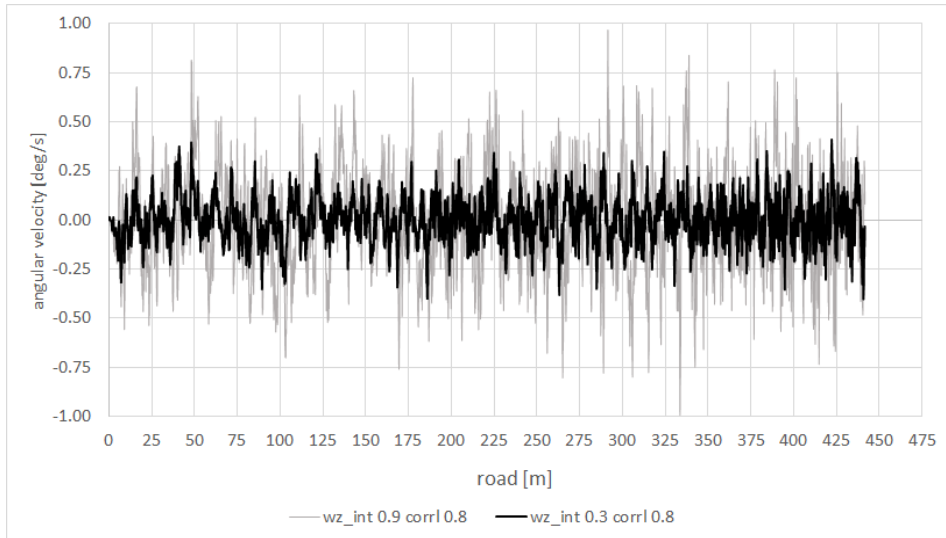

Fig. 26. Angular velocity around the vertical axis on a dry, randomly uneven road surface with the almost similar left and right profiles of irregularities as well as different amplitudes of these irregularities

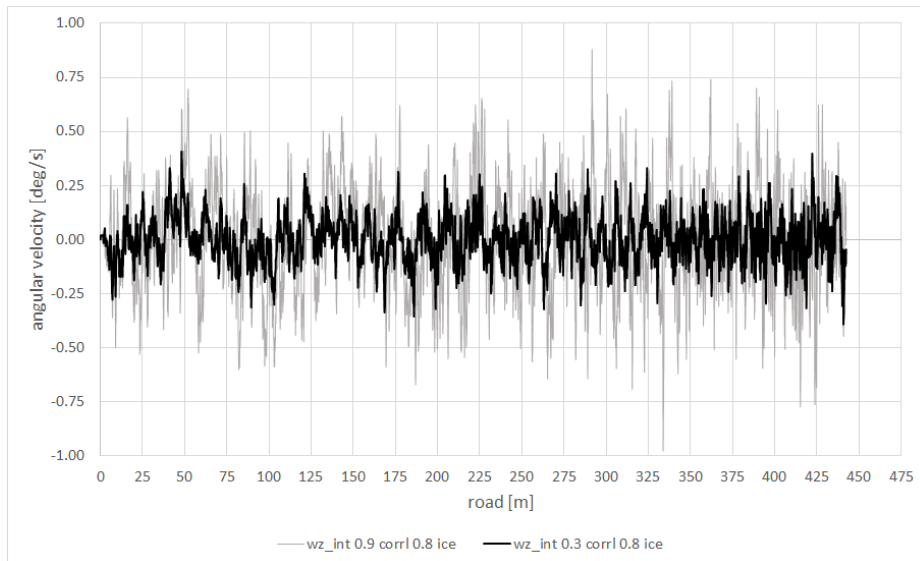

Fig. 27. Angular velocity around the vertical axis on an icy, randomly uneven road surface with the almost similar left and right profiles of irregularities as well as different amplitudes of these irregularities

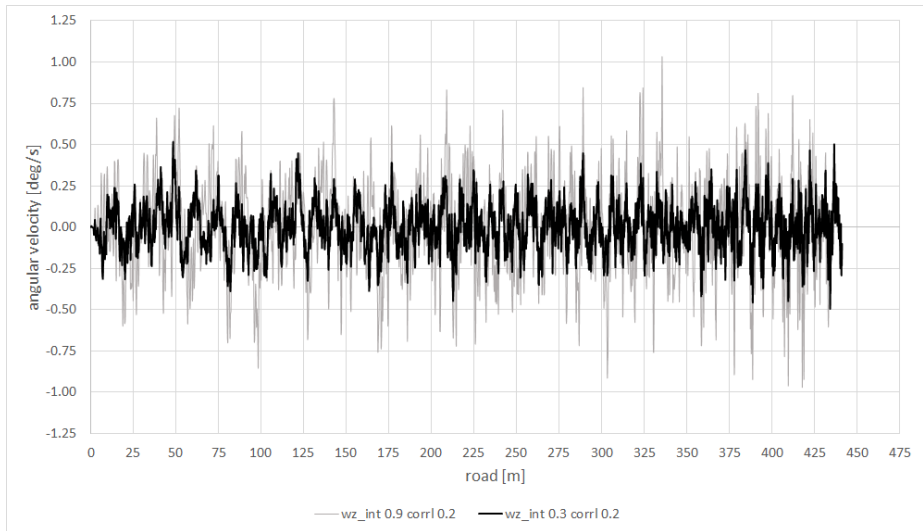

Fig. 28. Angular velocity around the vertical axis on a dry, randomly uneven road surface with the almost different left and right profiles of irregularities as well as different amplitudes of these irregularities

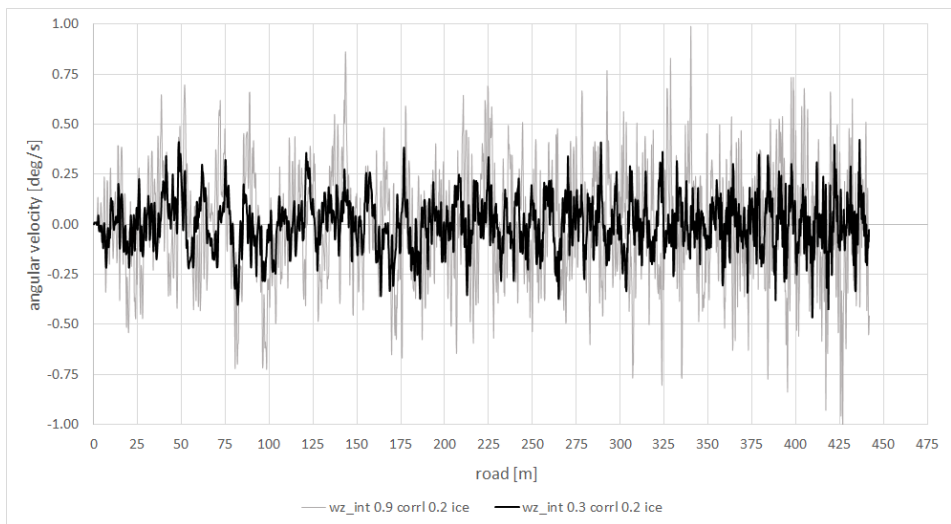

Fig. 29. Angular velocity around the vertical axis on an icy, randomly uneven road surface with the almost different left and right profiles of irregularities as well as different amplitudes of these irregularities

It is also visible that the greater values of the angular velocity occurred for the road surface with the irregularities having the higher amplitude (intensity 0.9, contrary to the lower amplitudes with intensity 0.3), no matter if the the road profiles for left and right wheels were almost similar (corr1 = 0.8) or

different (corr1 = 0.2). This indicates that the icy road surface may cause more difficult riding conditions for the vehicle, even if the road is in poor condition and its irregularities could be expected to reduce the yaw effect of the vehicle.

4. Conclusions

From the proposed and presented analysis random irregularities, independently on their maximum height, may cause disturbances in the vehicle motion even in lateral direction despite the straightforward motion and the straight-line control. Icy road surface did not seem to affect the adopted course of the vehicle as much as the amplitude of road irregularities, because in all figures it can be observed that for the intensity 0.9 the obtained values were higher than those for the intensity 0.3. It seems obvious that for the turning maneuver it could have greater effect on the vehicle behavior.

It can also be concluded that the straight-line course forced by the simulation program may in some manner not give the full answer as for the response of the vehicle in the adopted road conditions. However the values obtained for the higher amplitudes of random irregularities of the road surface enable expectations that this is the main reason of the vehicle's deviation from the adopted direction of motion.

In further research one major step will be undertaken. The control of the straightforward motion will be switched off in order to examine the potential influence of the adopted road conditions on the behavior of a vehicle without trajectory correction by the driver.

References

- [1] BEST, M. C., 2019. Real-time characterisation of driver steering behaviour. *Vehicle System Dynamics*, Vol. 57, Issue 1, 64-85.
- [2] KISIŁOWSKI, J., ZALEWSKI, J., 2016. Analysis of the stochastic technical stability of engineering structures on example of moving car. *Journal of Theoretical and Applied Mechanics*, vol. 54, no. 4, 1157-1167.
- [3] KISIŁOWSKI, J., ZALEWSKI, J., 2018. Selected examples of referring the examined stochastic technical stability to the ISO standards. *Journal of Theoretical and Applied Mechanics*, vol. 56, no. 1, 313-321.
- [4] MACIOSZEK, E., 2015, The road safety at turbo roundabouts in Poland. *Archives of Transport*, Vol. 33, Issue 1, 57-67.
- [5] MASTINU, G., PLOCHL, M., 2014. Road and Off-Road Vehicle System Dynamics Handbook, 1st Edition. CRC Press, Boca Raton, eISBN 9780429129810.
- [6] MITAS, A. W., KONIOR, W., 2012. Vehicles in Motion Parameters Measurement Pre-Selection System. *Archives of Transport*, Vol. 24, No. 1, 43-61.
- [7] MÚČKA, P., 2016. Current approaches to quantify the longitudinal road roughness. *International Journal of Pavement Engineering*, Vol. 17, Issue 8, 659-679.
- [8] NI, L., GUPTA, A., FALCONE, P., JOHANNESON L., 2016. Vehicle Lateral Motion Control with Performance and Safety Guarantees. *IFAC – Papers On Line*, Vol. 49, Issue 11, 285-290.
- [9] RILL, G., 2011. Road Vehicle Dynamics: Fundamentals and Modeling, 1st Edition. CRC Press, ISBN 9781439838983.
- [10] SHAO, L., JIN, C., LEX, C., EICHBERGER, 2019. Robust road friction estimation during vehicle steering. *Vehicle System Dynamics*, Vol. 57, Issue 4, 493-519.
- [11] SHI, Y., LI, B., LUO, J., YU, F., 2019. A practical identifier design of road variations for anti-lock brake system. *Vehicle System Dynamics*, Vol. 57, Issue 3, 336-368.
- [12] ŚLASKI, G., PISKORZ, H., 2011, The Influence of Damping Changes on Vertical Dynamic Loads of Wheel – Experimental Investigations. *Archives of Transport*, Vol. 23, No. 2, 239-247.
- [13] ZALEWSKI, J., 2018. Influence of Randomly Uneven Roads on Selected Problems of Motor Vehicle Motion. In: *Management Perspective for Transport Telematics, Communications in Computer and Information Science 897, International Conference on Transport Systems Telematics*. Kraków. Springer, 185-196.