

# Pilot Based MMSE Channel Estimation for Spatial Modulated OFDM Systems

Anetha Mary Soman, Nakkeeran.R, and Shinu Mathew John

**Abstract**—Due to the multifold growth in demands of multimedia services and mobile data, the request for increased channel capacity in mobile and wireless communication has been quickly increasing. Developing a wireless system with more spectral efficiency under varying channel condition is a key challenge to provide more bit rates with limited spectrum. Multiple Input Multiple Output(MIMO) system with Orthogonal Frequency Division Multiplexing (OFDM) gives higher gain by using the direct and the reflected signals, thus facilitating the transmission at high data rate. An integration of Spatial Modulation (SM) with OFDM (SM OFDM) is a newly evolved transmission technique and has been suggested as a replacement for MIMO -OFDM transmission. In practical scenarios, channel estimation is significant for detecting transmitted data coherently. This paper proposes pilot based, Minimum Mean Square Error (MMSE) channel estimation for the SM OFDM communication system. We have focused on analyzing Symbol Error Rate (SER) and Mean Square error (MSE) under Rayleigh channel employing International Telecommunication Union (ITU) specified Vehicular model of Pilot based MMSE channel estimator using windowed Discrete Fourier Transform (DFT) and MMSE weighting function. Simulation output shows that proposed estimator's SER performance lies close to that of the MMSE optimal estimator in minimizing aliasing error and suppressing channel noise by using frequency domain data windowing and time domain weighting function. Usage of the Hanning window eliminates error floor and has a compact side lobe level compared to Hamming window and Rectangular window. Hanning window has a larger MSE at low Signal to Noise Ratio (SNR) values and decreases with high SNR values. It is concluded that data windowing technique can minimize the side lobe level and accordingly minimize channel estimation error when interpolation is done. MMSE weighting suppresses channel noise and improves estimation performance. Since Inverse Discrete Fourier Transform(IDFT)/DFT transforms can be implemented with fast algorithms Inverse Fast Fourier Transform( IFFT)/Fast Fourier Transform(FFT) computational complexity can be remarkably reduced.

**Keywords**—MIMO, Multicarrier modulation, Spatial Modulation, Channel Estimation, Channel Models, Interpolation

Anetha Mary Soman and R. Nakkeeran is with Department of Electronics Engineering, School of Engineering and Technology, Pondicherry Central University, Pondicherry, India (e-mail: anethashinu@gmail.com, nakkeeranpu@gmail.com).

Shinu Mathew John is with Department of Computer Science, St.Thomas College of Engineering & Technology, Kannur,Kerala,India (e-mail: shinu.cse@gmail.com).

## I. INTRODUCTION

Nevertheless of the use as diversity or spatial multiplexing system, the dominant limitations of conventional MIMO system are increased complexity, increased power or energy utilization and intense cost [1]. SM, a low complexity replacement to conventional MIMO schemes of transmission proposed by Meshleh alleviates these problems [2]. In SM system, data get transmitted from an arbitrarily chosen active antenna of the MIMO transmitter along wireless channel. It employs transmit antenna index to convey information, the spatial dimension as well as the two dimensional signal constellation and save implementation cost by minimizing the count of radio frequency chains [2]. Paper [3] comes up with a comprehensive outline of current outcomes and advancement in SM research. A multicarrier transmission, OFDM is a robust modulation technique for higher data rate wireless communication systems. Its advantages include an increase in bandwidth efficiency, reduction of Inter Symbol Interference (ISI), viability of less cost transceivers, etc. [4]. SM and OFDM happened to merge recently to take supremacy to perform good communication over wireless links [5]. For the systematic implementation of coherent receiver, channel estimation plays an essential part. Channel estimation is a significant and demanding issue in wireless systems because of time variance and frequency selectivity characteristics of channels. With respect to coherent SM OFDM systems, channel estimation depends on training sequences chosen and channel characteristics. Pilot tone based estimation is one among the favored technique for selective fading channels [6, 7]. The estimation technique with interpolation is extensively used in communication systems, in particular Wi-max [8], 3GPP, LTE [9]. For OFDM systems such estimation technique was proposed in [10-12]. Interpolation techniques such as Linear, Low pass, Spline and time domain interpolation have been explored in [10]. Paper [13] discusses estimation of channel for SM OFDM systems using different types of interpolation in presence of selective channel. In this paper, pilot based channel estimation scheme is put forward for SM OFDM systems. The design of pilot assisted channel estimation algorithm for SM OFDM is entirely different compared to conventional pilot assisted channel estimation technique due to the different frame structure since single antenna at transmit side is activated and remaining antennas are idle for each subcarrier in the presence of rapidly varying



channels. This work assumes that signal is sent over multiple paths Rayleigh fading channel described by

$$h(\tau, t) = \sum_{i=1}^P h_i(t) \cdot \delta(\tau - \tau_i) \quad (1)$$

$\{h_i(t)\}$  represents multipath complex gains,  $\{\tau_i\}$  represents multipath time delays,  $P$  represents number of paths. The path gains are not correlated with each other. At the receiver side, channel is quasistationary. Time and frequency synchronization is perfect with assumption that guard interval duration greater than maximum delay spread. Channel estimation using comb type pilots relies on Least Square (LS) and MMSE estimators where computational complexity of MMSE optimal estimator is intense [14]. Literature [15-18] details MMSE interpolator for channel estimation of OFDM systems which requires a power delay profile of channel and Doppler frequency. To enhance the characteristics of estimation and to find estimates on entire subcarriers interpolation is done. The interpolation process is denoted as

$$\hat{H} = Q\hat{H}_{LS \text{ or } MMSE} \quad (2)$$

Where  $Q$  represents an interpolation matrix. The aim of estimation of the channel is to acquire  $Q$  with less computation and to attain greater accuracy for a given system. A channel estimator based on DFT with low complexity is a right choice [19-23]. DFT is an easy and computationally structured procedure for performing interpolation. Direct DFT method degrades in performance if multiple path time delays are non integer multiples of sampling time [24]. The equivalent channel response spreads to an interval in excess of delay spread due to the existence of finite subcarriers. Direct DFT method cause error floor as sampling the channel frequency response in frequency domain overlaps in time domain. Error floor or aliased spectral leakage is avoided by applying data windowing before DFT interpolation to observation vector. Also applying a weighting function suppresses the spreading of noise power.

This paper proposes Pilot based MMSE channel estimator using windowed DFT with less complexity under Rayleigh channel employing ITU specified Vehicular model for an SM OFDM system. The proposed estimator uses windowed filter in the frequency domain, and then choose a specific side lobe characteristics of the data window to decrease the inverse Fourier transformed channel impulse response, thereby improving the channel estimation results. It produces better SER performance when compared with optimal and direct DFT MMSE estimator by reducing aliasing error and suppressing channel noise by using frequency domain data windowing and time domain weighting function.

The remaining paper is ordered as follows. Section II illustrates system model for SM OFDM systems. Section III explains channel estimation process. Section IV introduces the time domain weighting scheme. Section V briefs MMSE optimal estimator. Section VI discusses the Method. Section VII provides Result and Discussion and Section VIII provides Conclusion.

## II. SM OFDM SYSTEM MODEL

An SM OFDM system model is shown in Fig.1. Let  $Z(k)$  represents  $d \times N$  matrix of uncorrelated binary data to be transmitted. From the matrix,  $d$  represents entire number

of bits/ symbol in a subcarrier,  $N$  represents entire number of OFDM subcarriers. Based on SM mapper represented in Fig. 2, the data  $Z(k)$  is mapped to an  $N_t \times N$  matrix  $X(k)$ ,  $N_t$  represents entire number of antennas used for transmission. In the matrix, the entire element of  $X(k)$  remain zero excluding the mapped location indices of the transmitting antenna. On each OFDM sub channel, number of bits transmitted is represented as

$$m = \log_2(N_t) + \log_2 M \quad (3)$$

$M$  represents the modulation degree.

Each row vector of  $X(k)$  dealt by OFDM modulator gets transformed from serial to parallel form. The data elements in each row are known as subcarrier. There are  $N$  numbers of subcarriers in an OFDM symbol consisting of  $N$  data symbols. To transmit known data, pilot insertion is done, which aid estimation of channel at the receiver.

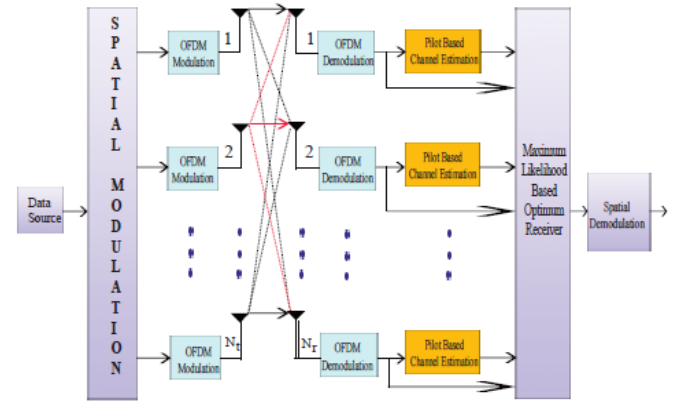

Fig.1. SM OFDM System Model

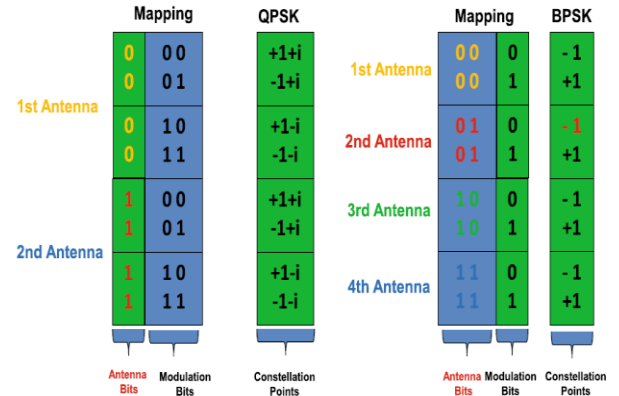

Fig.2. SM Mapper

Inverse DFT operation is carried out on each row vector of  $X(k)$  and transmits from the  $p^{th}$  antenna as

$$x_p(n) = \sqrt{\frac{1}{N}} \sum_{k=0}^{N-1} X_p(k) e^{j\frac{2\pi kn}{N}} \quad 0 \leq (n, k) \leq N \quad (4)$$

$N$  represents number of FFT points. Cyclic prefix (CP) is affixed at starting of each OFDM symbol. This prevents distortion produced by Inter Symbol Interference (ISI) in the channel. CP is the copy of rear part of the particular OFDM symbol. The resultant OFDM symbol after insertion of CP is

transformed to serial form and gets passed through MIMO channel.

At receiver, symbols are initially transformed to parallel form following CP removal. Frequency domain symbols are obtained by passing the OFDM symbols through DFT block. These symbols are used to estimate the channel by a pilot based equalizer. Further procedure processes the obtained data to estimate the transmitted OFDM symbols. Parallel to serial conversion takes place and demapping is done such that the binary data is obtained as transmitted. The OFDM demodulator output for  $k^{th}$  subcarrier are written as.

$$\begin{bmatrix} y_1(k) \\ \vdots \\ y_r(k) \\ \vdots \\ y_{N_r}(k) \end{bmatrix} = \begin{bmatrix} h_{1,1}(k) & h_{1,2}(k) & \dots & h_{1,N_t}(k) \\ h_{2,1}(k) & h_{2,2}(k) & \dots & h_{2,N_t}(k) \\ \vdots & \vdots & \ddots & \vdots \\ \vdots & \vdots & \ddots & \vdots \\ h_{N_r,1}(k) & h_{N_r,2}(k) & \dots & h_{N_r,N_t}(k) \end{bmatrix} \begin{bmatrix} 0 \\ \vdots \\ x_q(k) \\ \vdots \\ 0 \end{bmatrix} + \begin{bmatrix} w_1(k) \\ \vdots \\ w_r(k) \\ \vdots \\ w_{N_r}(k) \end{bmatrix} \quad (5)$$

where  $h_{r,p}(k)$  represents statistically independent channel coefficient between transmit antenna  $p$  and receive antenna  $r$ ,  $x_q(k)$  represents  $q^{th}$  active antenna symbol from constellation figure and  $w_r(k)$  represents complex valued White Gaussian Noise with variance  $\sigma_{\omega^2}$  and zero mean. Matrix representation of signal model is rewritten in the form

$$y(k) = H(k)x_p(k) + w(k) \quad k = 1, 2, \dots, N \quad (6)$$

$$\text{Where } x_p(k) = \begin{bmatrix} 0 \dots \dots \dots \underbrace{x_q(k)}_{p\text{-transmitted antenna}} \dots \dots \dots 0 \end{bmatrix}^T$$

### III. CHANNEL ESTIMATION PROCESS

Practically Channel State information (CSI) is required to find transmitted symbols and active transmit antenna index for an SM OFDM system on the receiver side. Fig.3 represents the frame format of SM OFDM system. In figure, pilot tones are placed periodically over subcarriers and for the respective OFDM symbol number, each transmit antenna pass on pilots and hence frequency variation of channel gets tracked.

Assume subcarriers used for transmission as  $N_v + 1$  among  $N$  subcarriers and remaining are prearranged as guard bands and also assume  $M_p + 1$  pilot subcarriers are placed in  $N_v + 1$  subcarriers considered for channel estimation, where  $M_p = N_v/D, D$  denotes an integer for each OFDM symbol with respect to transmit antenna concerned. The proposed MMSE channel estimator is shown in Fig.4.

The estimation process is carried out once the channel frequency response observation vector is acquired. Windowing process is then applied to minimize channel estimation error or to lessen spectral leakage. Rectangular, Hamming and Hanning windows are considered in this process. Fig.5 shows Frequency response plots for the window functions. The rectangular window has narrowest main lobe, imparting finest frequency resolution for spectrum analysis. The initial side lobe of rectangular window falls 13 dB beneath the crest of main lobe, which is hardly acceptable and increases leakage. The Hamming and Hanning windows lessen the levels of side

lobes. Their main lobes are nearly twice as broad as the main lobe of rectangular window depending on how the main lobe width is defined. The broader main lobes reduce frequency resolution but small side lobes significantly decrease leakage. M point IDFT is applied to convert windowed frequency response to time domain response and gets modified by MMSE weighting function such that MSE is reduced for the given window function. DFT is done to convert the result back to frequency domain and channel estimation output is eventually obtained by removing the windowing effect.

Let pilot subcarriers channel responses in the frequency domain are denoted as

$$\tilde{h}_p = [\tilde{H}_{-(\frac{M_p}{2})D} \dots \dots \dots \tilde{H}_{(\frac{M_p}{2})D}]^T.$$

Least Square estimate is applied to obtain channel responses at pilot subcarriers where number of pilot subcarriers

$M > \tau_{max}/T_s$  to avoid aliasing,  $\tau_{max}$  being maximum delay and  $T_s$  the sampling time.

$$\begin{aligned} \hat{H}_{mD} &= Z_{mD}/X_{mD} \\ &= H_{mD} + \frac{n_{mD}}{X_{mD}} \quad m = -\frac{M_p}{2} \dots \dots \dots \frac{M_p}{2} \quad (7) \end{aligned}$$

The power delay profile of channel  $P(\tau)$  is considered over the interval  $0 \leq \tau \leq \Delta$  and gets shifted by  $-\frac{\Delta}{2}$  to center the profile on delay zero by phase rotation in frequency domain for performing interpolation. The window function is then applied to  $\tilde{h}_p$  to minimize spectral leakage and thereby data can be brought evenly to zero at the boundaries and discontinuities can be minimized.

Mathematically

$$\hat{H}_{mD}^{(d)} = \hat{H}_{mD} W_x(m) e^{j\pi(m\Delta/MT)}$$

$$\text{Where } w_1(m) = 1 \text{ for } |m| \leq M_p / 2$$

$$w_2(m) = \left( 0.54 + 0.46 \cos \frac{2\pi m}{\gamma} \right) |m| \leq M_p / 2$$

$$w_3(m) = \left( 0.5 + 0.5 \cos \frac{2\pi m}{\gamma} \right) |m| \leq M_p / 2 \quad (8)$$

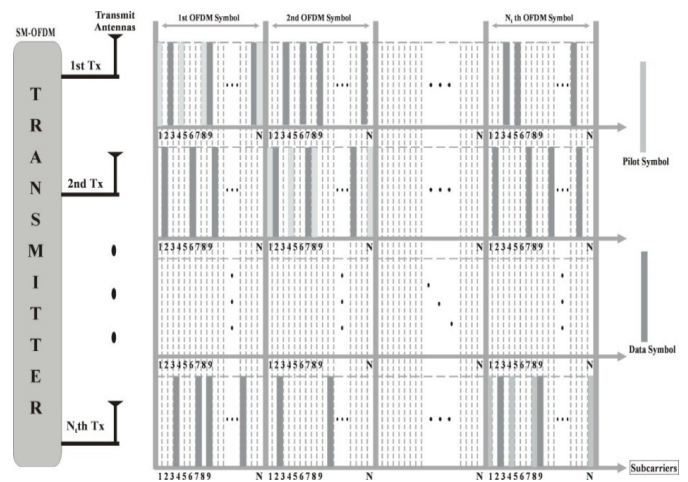

Fig.3. Comb type pilot based frame structure

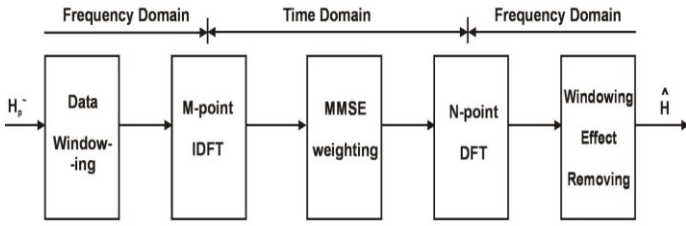

Fig.4. Windowed DFT MMSE channel estimator

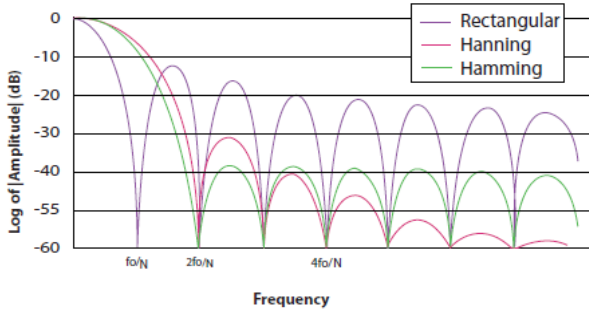

Fig.5. Frequency response plots for rectangular, Hanning and Hamming windows

$w_1(m), w_2(m), w_3(m)$  denotes the rectangular, Hamming and Hanning window functions where the variable  $\gamma$  controls the window shape.

Next we apply IDFT to obtain channel impulse response in time domain  $\tilde{q}_n$  as

$$\tilde{q}_n = \frac{1}{M} \sum_{m=-M_p/2}^{M_p/2} \hat{H}_{mD} e^{j\frac{2\pi}{M}mn} - \frac{M}{2} + 1 \leq n \leq \frac{M}{2} \quad (9)$$

where  $\tilde{q}_n$  and  $\hat{H}_{mD}^{(d)}$  are supposed to be periodic. After that apply Time domain weighting function  $w(n)$  given by  $w(n) = [w_{-M/2+1+d} w_{-M/2+2+d} \dots w_{-M/2+d}]^T$  (10) to  $\tilde{q}_n$  to minimize MSE,  $d$  being the left boundary of the window.

As next step pad zeros to weighted channel impulse response sequence to create a new  $N$  sample sequence with  $D > 1$  as,

$$h_N^{1(q)}(n) = \begin{cases} 0 \text{ for } -N/2 + 1 \leq n \leq -M/2 - 1 \\ \tilde{q}_n w(n) \text{ for } n = -M/2 \\ \tilde{q}_n w(n) \text{ for } -M/2 + 1 \leq n \leq M/2 \\ 0 \text{ for } M/2 + 1 \leq n < N/2 \end{cases} \quad (11)$$

Next apply Fourier Transform to windowed channel impulse response as,

$$\hat{H}_k = \sum_{n=-M/2+1+d}^{M/2+d} h_N^{1(q)}(n) e^{-j\frac{2\pi kn}{N}} k = -N_v/2 \dots N_v/2 \quad (12)$$

Finally estimation output is obtained by detaching windowing and phase rotation effects

$$\hat{H}_n = \frac{\hat{H}_k e^{j\pi(\frac{nD}{NT})}}{w^1(k)} k = \frac{-N_v}{2} \dots \frac{N_v}{2} \quad (13)$$

where  $w^1(k)$  is the rectangular, Hamming, Hanning window sequence of length  $N_v + 1$  given by

$$\begin{aligned} w_1^1(k) &= 1 \text{ for } |n| \leq N_v / 2 \\ w_2^1(k) &= (0.54 + 0.46 \cos \frac{2\pi n}{\gamma D}) |n| \leq N_v / 2 \\ w_3^1(k) &= (0.5 + 0.5 \cos \frac{2\pi n}{\gamma D}) |n| \leq N_v / 2 \end{aligned} \quad (14)$$

#### IV. TIME DOMAIN WEIGHTING SCHEME

The MMSE weighting scheme is selected such that the MSE between true channel response and estimated coefficients is reduced. Let pilot subcarriers channel responses in the frequency domain are denoted as

$$\tilde{h}_p = [\tilde{H}_{-(M_p/2)D} \dots \tilde{H}_{(M_p/2)D}]^T \quad (15)$$

and estimated responses as

$$\hat{h} = [\hat{H}_{-(N_v/2)} \hat{H}_{-(N_v/2)+1} \dots \hat{H}_{(N_v/2)}]^T \quad (16)$$

Applying weighting vector  $w$  to time domain channel impulse response, then matrix form representation of  $\hat{h}$  is

$$\hat{h} = F_d \cdot \text{diag}(w) \cdot G_d \tilde{h}_p \quad (17)$$

function  $\text{diag}(\cdot)$  is a matrix whose diagonal elements are entries in its argument.

Matrix

$$G_d = \frac{1}{M} \begin{bmatrix} e^{j2\pi(-\frac{1}{2}M+d+1)(-\frac{1}{2}M_p)/N} & \dots & e^{j2\pi(-\frac{1}{2}M+d+1)(\frac{1}{2}M_p)/N} \\ \vdots & \ddots & \vdots \\ e^{j2\pi(\frac{1}{2}M+d)(-\frac{1}{2}M_p)/N} & \dots & e^{j2\pi(\frac{1}{2}M+d)(\frac{1}{2}M_p)/N} \end{bmatrix} \quad (18)$$

is the  $M \times (M_p + 1)$  IDFT matrix.

$$\text{Matrix } F_d =$$

$$\begin{bmatrix} e^{-j2\pi(-\frac{1}{2}M+d+1)(-\frac{1}{2}N_v)/N} & \dots & e^{-j2\pi(\frac{1}{2}M+d)(-\frac{1}{2}N_v)/N} \\ \vdots & \ddots & \vdots \\ e^{-j2\pi(-\frac{1}{2}M+d+1)(\frac{1}{2}N_v)/N} & \dots & e^{-j2\pi(\frac{1}{2}M+d)(\frac{1}{2}N_v)/N} \end{bmatrix} \quad (19)$$

is the  $(N_v + 1) \times M$  DFT matrix and variable  $d$  manage time domain samples for windowing.

The MMSE weighting scheme is obtained as [14]

$$\begin{aligned} w_{MMSE} &= (E\{\text{diag}(G_d \tilde{h}_p)^H F_d^H F_d \text{diag}(G_d \tilde{h}_p)\})^{-1} \cdot E\{\text{diag}(G_d \tilde{h}_p)^H F_d^H \hat{h}\} \\ &= \left[ (G_d R_{\tilde{h}_p \tilde{h}_p} G_d^H) \otimes (F_d^H F_d) \right]^{-1} \cdot \text{diag}^{-1} (F_d^H R_{\hat{h} \hat{h}} G_d^H) \end{aligned} \quad (20)$$

Where  $\otimes$  specify a component wise product and  $diag^{-1}(\cdot)$  give rise to a column vector whose diagonal elements are entries in its argument.

V. MMSE OPTIMAL ESTIMATOR

Fig.6 shows the MMSE Estimation approach. It has the property of orthogonality as

$$E[eH_{LS}^H] = 0 \tag{22}$$

Where error function,  $e = H - H_{MMSE}$ ,  $H$  denotes true channel estimate and  $H_{MMSE} = W_{MMSE}H_{LS}$  denotes raw channel estimate.

Deriving the MMSE weighting  $W_{MMSE}$  from equation (22) as

$$\begin{aligned} E[(H - H_{MMSE})H_{LS}^H] &= 0 \\ E[(H - W_{MMSE}H_{LS})H_{LS}^H] &= 0 \\ E[HH_{LS}^H - W_{MMSE}H_{LS}H_{LS}^H] &= 0 \\ R_{HH_{LS}} - W_{MMSE}R_{H_{LS}H_{LS}} &= 0 \\ W_{MMSE} &= R_{HH_{LS}}R_{H_{LS}H_{LS}}^{-1} \end{aligned} \tag{23}$$

where  $R_{HH_{LS}}$  represents covariance matrix between true channel and channel estimated and  $R_{H_{LS}H_{LS}}$  represents covariance matrix of channels estimated.

MMSE Estimator is obtained as

$$H_{MMSE} = R_{HH_{LS}}R_{H_{LS}H_{LS}}^{-1}H_{LS} \tag{24}$$

$$H_{MMSE} = R_{HH}(R_{HH} + \sigma_N^2(XX^H)^{-1})^{-1}H_{LS} \tag{25}$$

Where  $\sigma_N^2$  represents the variance of AWGN.

VI. METHODS

This paper compares channel estimation techniques of Pilot based MMSE channel estimator using windowed DFT and MMSE weighting function with optimal and direct DFT MMSE estimator in the presence of Rayleigh channel employing ITU -T Vehicular channel model. SER is used as parameter metric for channel estimation. Also MSE performances of windows are obtained.

The following assumptions are made in the simulation.

- a) Normalized Total transmit power
- b) Uncorrelated Data symbols
- c) Statistically independent Multipath channels for the different pathways
- d) Perfect Time and Frequency synchronization
- e) Guard interval greater than maximum delay spread.
- f) Simulations for different SNR ( $E_s/N_0$ )
- g) Rayleigh channel employing Vehicular channel model proposed by ITU project [25-26].

Table I shows multipath tap delay profile for the test environment

VII. RESULTS AND DISCUSSIONS

This section quantifies SER and MSE performance of  $4 \times 4$  SMOFDM system based on proposed channel estimation algorithm under Rayleigh channel. System parameters employed for the simulation are specified in Table II.

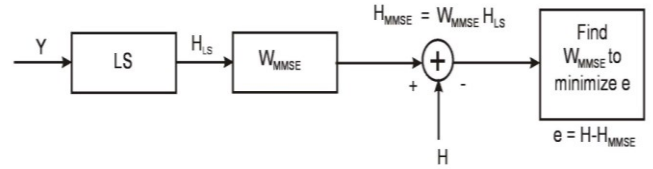

Fig.6.MMSE Approach

TABLE I  
TAPPED DELAY PROFILE OF ITU-T

Tap	Relative Delay (ns)	Average power (dB)	Doppler spectrum
1	0	0	Classic
2	310	-1	Classic
3	710	-9	Classic
4	1090	-10	Classic
5	1730	-15	Classic
6	2510	-20	Classic

TABLE II  
SYSTEM PARAMETERS

System Parameters	Value
Carrier frequency	2 GHz
Total number of subcarriers(N)	1024
Subcarriers used for transmission (Nv+1)	901
Pilot Subcarriers(Mp)	32
Interval between two adjacent pilots (D)	32
Guard length	16
SNR	40 dB
Total number of symbols	10000
Doppler frequency (f <sub>D</sub> )	100 Hz
Channel property	Rayleigh channel employing ITU-T Channel model
Modulation Scheme	16-QAM
Channel length(P)	6
Symbol length	205* 10 <sup>-6</sup> sec
Sample Period(Ts)	0.2* 10 <sup>-6</sup> sec
Bandwidth	5 MHz

The SER performance based on proposed estimator, MMSE optimal estimator, MMSE estimator with DFT are as shown in Fig.7. The suggested estimator performance using Hanning window is very near to that of the optimal one. SER performance for perfect CSI is also shown for reference. The windows that determine selected samples as per the sample magnitude and that depend on a threshold at low SNR minimize the estimation error level. For rectangular window or Direct DFT MMSE estimator, aliasing error is large and causes

error floor. For Hamming and Hanning window, error floor is not observed at high SNR. Windowed DFT minimize the aliasing error of direct DFT based channel estimation method. The MSE performance of the windows considered are shown in Fig.8. Hanning window has a larger MSE at low SNR values and decreases with high SNR values. Out of the three windows considered, Hanning window has a compact side lobe level and aliasing error. This channel estimation method shows great possibilities to satisfy the requirements of new wireless communication system.

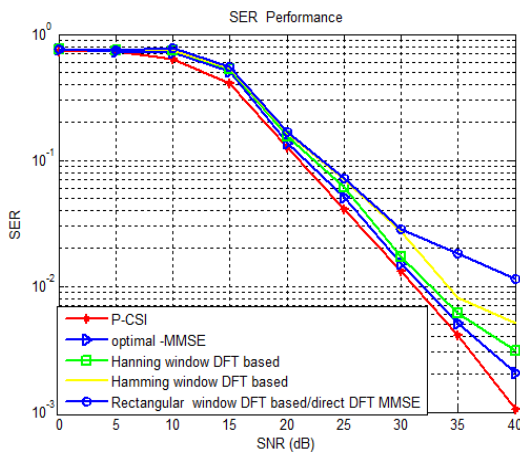

Fig.7. SER Performance

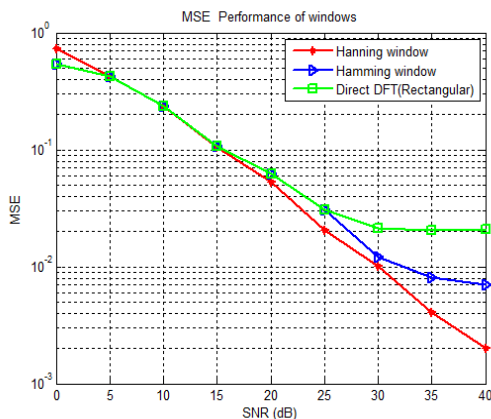

Fig.8. MSE performance

### CONCLUSION

This paper addressed the channel estimation process of the SM OFDM communication system. We have focused on analyzing the SER performance of Pilot based MMSE channel estimator using windowed DFT with optimal and direct DFT MMSE estimator under the multipath fading channel. MSE performance of windows is also analyzed. It is concluded that data windowing technique can minimize the side lobe level and accordingly minimize channel estimation error when interpolation is done. Removal of window effect on the estimated channel frequency response amplifies noise level. For non sampled spaced path time delays, usage of data window can reduce aliasing error. Since MSE depends on window shape, a suitable data windowing technique is considered to minimize MSE. Data windowing with Hanning window can eliminate error floor. It has a larger MSE at low

SNR values and decreases with high SNR values. MMSE weighting suppresses channel noise and improves estimation performance. Since IDFT/DFT transforms can be implemented with fast algorithms IFFT/FFT computational complexity can be remarkably reduced.

### REFERENCES

- [1] A. Mohammadi, F.M. Ghannouchi, "Single RF front-end MIMO transceivers," in *RF transceiver design for MIMO wireless communications*, Springer, Berlin, Heidelberg, :pp. 265-288,2012.
- [2] R. Mesleh, H. Haas, C.W. Ahn, S. Yun, "Spatial modulation-a new low complexity spectral efficiency enhancing technique," in *2006 First International Conference on Communications and Networking in China* (pp. 1-5). IEEE, Oct 25 2006.
- [3] M. Wen, B. Zheng, K.J. Kim, M. Di Renzo, T.A. Tsiftsis, K.C. Chen, N. Al-Dhahir, "A survey on spatial modulation in emerging wireless systems: Research progresses and applications," *IEEE Journal on Selected Areas in Communications*,;37(9):1949-72, Jul 17,2019.
- [4] H. Doğan, E. Panayircı, H.V. Poor, "Low-complexity joint data detection and channel equalisation for highly mobile orthogonal frequency division multiplexing systems," *IET communications*, 4(8):1000-11, May 21,2010.
- [5] H. Haas, S. Sinanovic, C.W. Ahn, S. Yun, "Spatial modulation," *IEEE Trans. Veh. Technol.*, 57(4):2228-41, Jul 2008.
- [6] M. Biguesh, A.B. Gershman, "Training-based MIMO channel estimation: a study of estimator tradeoffs and optimal training signals," *IEEE transactions on signal processing*, 54(3):884-93, Feb 21, 2006.
- [7] M. Yalcin, A. Akan, H. Doğan, "Low-complexity channel estimation for OFDM systems in high-mobility fading channels," *Turkish Journal of Electrical Engineering & Computer Sciences*, 25;20(4):583-92, Apr. 2012.
- [8] J.G. Andrews, A. Ghosh and R. Muhamed, "Fundamentals of WiMAX: understanding broadband wireless networking," Pearson Education; Feb 27,2007.
- [9] E. Dahlman, S. Parkvall, J. Skold, "4G: LTE/LTE- advanced for mobile broadband," Academic press; Oct 7,2013.
- [10] S. Coleri, M. Ergen, A. Puri, A. Bahai, "Channel estimation techniques based on pilot arrangement in OFDM systems," *IEEE Transactions on broadcasting*, 7;48(3):223-9, Nov 2002 .
- [11] Y. Wu, Y. Zhao, D. Li, "Channel estimation for pilot-aided OFDM systems in single frequency network," *Wireless Personal Communications*, 1;62(1):227-45,Jan 2012.
- [12] H. Doğan, "On detection in MIMO-OFDM systems over highly mobile wireless channels," *Wireless personal communications*, 86(2):683-704, Jan 2016 .
- [13] Y. Acar, H. Doğan, E. Panayircı, "Pilot symbol aided channel estimation for spatial modulation-OFDM systems and its performance analysis with different types of interpolations," *Wireless Personal Communications*, 1;94(3):1387-404, Jun 2017.
- [14] M. Speth, S. Fechtel, G. Fock, H. Meyr, "Broadband transmission using OFDM: System performance and receiver complexity," in *1998 International Zurich Seminar on Broadband Communications. Accessing, Transmission, Networking. Proceedings* (Cat. No. 98TH8277) (pp. 99-104). IEEE, Feb 1998.
- [15] F. Ling, C.L. Nikias, J.G. Proakis, C.M. Rader, "Advanced digital signal processing," Macmillan; 1992.
- [16] B. Yang, Z. Cao, K.B. Letaief, "Analysis of low-complexity windowed DFT-based MMSE channel estimator for OFDM systems," *IEEE Transactions on Communications*, 49(11):1977-87, Nov 2001.
- [17] Y. Li, "Pilot-symbol-aided channel estimation for OFDM in wireless systems," *IEEE transactions on vehicular technology* ,49(4):1207-15, Jul 2000
- [18] P. Hoeher, S. Kaiser, P. Robertson, "Two-dimensional pilot symbol-aided channel estimation by Wiener filtering," in *1997 IEEE international conference on acoustics, speech, and signal processing* (Vol. 3, pp. 1845-1848). IEEE, Apr 1997.
- [19] Y. L. Li, L.J. Cimini, N. R. Sollenberger, "Robust channel estimation for OFDM systems with rapid dispersive fading channels," *IEEE Transactions on communications* ;46(7):902-15, Jul 1998.
- [20] O. Edfors, M. Sandell, J.J. Van De Beek, S.K. Wilson, P.O. Börjesson, "Analysis of DFT-based channel estimators for OFDM," *Wireless Personal Communications*,1;12(1):55-70, Jan 2000 .

- [21] V.K. Jones, G.C. Raleigh, "Channel estimation for wireless OFDM systems," in *IEEE GLOBECOM 1998* (Cat. NO. 98CH36250), Vol. 2, pp. 980-985, IEEE, Nov 8,1998.
- [22] Y. Zhao, A. Huang, "A novel channel estimation method for OFDM mobile communication systems based on pilot signals and transform-domain processing," in *1997 IEEE 47th Vehicular Technology Conference. Technology in Motion*, Vol. 3, pp. 2089-2093, IEEE, May 1997.
- [23] B. Yang, K.B. Letaief, R.S. Cheng, Z. Cao, "Windowed DFT based pilot-symbol-aided channel estimation for OFDM systems in multipath fading channels," in *VTC2000-Spring, 2000 IEEE 51st Vehicular Technology, 2000 Conference Proceedings* (Cat. No. 00CH37026) ,(Vol. 2, pp. 1480-1484). IEEE, May 15 ,2000.
- [24] J.J. Van De Beek, O. Edfors, M. Sandell, S.K. Wilson, P.O. Borjesson "On channel estimation in OFDM systems," in *1995 IEEE 45th Vehicular Technology Conference. Countdown to the Wireless Twenty-First Century*, Vol. 2, pp. 815-819, IEEE, Jul 25 ,1995.
- [25] ITU-R M.1225(1997) International Telecommunication Union, "Guidelines for evaluation of radio transmission technologies for IMT-2000," 1997.
- [26] M. Patzold, "Mobile fading channels," *Hoboken: Wiley*, 2003.