



MIDDLE POMERANIAN SCIENTIFIC SOCIETY
OF THE ENVIRONMENT PROTECTION

Monograph No. 1

Krzysztof Cichocki, Jacek Dowski,
Jacek Katzer, Mariusz Ruchwa

**Impact resistant concrete elements
with nonconventional reinforcement**

Koszalin 2014

ISSN 1506-218X

Scientific Committee – Editorial – Programming Board

Waldemar Borjaniec
(Scientific Secretary),
Tomasz Dąbrowski,
Włodzimierz Deluga,
Józef Domagała,
Zdzisław Harabin,
Jan Hehlmann,
Alexander V. Ivanov (Russia),
Renata Krzyżyńska,
Karl E. Lorber (Austria),
Lesław Macieik
(vice Secretary),

Hanna Obarska-Pempkowiak,
Janusz Pempkowiak,
Tadeusz Piecuch
(Chairman),
Jacek Piekarski
(vice Chairman),
Małgorzata Pilecka-Rapacz,
Wojciech Piotrowski
(vice Chairman),
Czesława Rosik-Dulewska,
Aleksander Szkarowski (Russia)
(vice Chairman),
Kazimierz Szymański.

Editor in Chief – Scientific Editor

Tadeusz Piecuch

Technical Editors

Janusz Dąbrowski, Tomasz Dąbrowski

Website Editor <http://ros.edu.pl>

Zdzisław Knap

Reviewers

Hubert Dębski, *Lublin University of Technology*
Jacek Gołaszewski, *Silesian University of Technology, Gliwice*

Publication of Middle Pomeranian Scientific Society
of The Environment Protection
Koszalin phone +48 94 3410542, +48 94 3478524, or 609800439

Edition 500 copies, 4,7 publishing sheets, format B-5
Printed by: INTRO-DRUK, Koszalin



ŚRODKOWO-POMORSKIE TOWARZYSTWO NAUKOWE
OCHRONY ŚRODOWISKA

Monografia nr 1

Krzysztof Cichocki, Jacek Dowski,
Jacek Katzer, Mariusz Ruchwa

**Elementy betonowe odporne
na uderzenia z niekonwencjonalnym
zbrojeniem**

Koszalin 2014

Komitet Naukowy – Wydawniczy – Rada Programowa

Waldemar Borjaniec
(Sekretarz Naukowy),
Tomasz Dąbrowski,
Włodzimierz Deluga,
Józef Domagała,
Zdzisław Harabin,
Jan Hehlmann,
Alexander V. Ivanov (Rosja),
Renata Krzyżyńska,
Karl E. Lorber (Austria),
Lesław Macieik
(z-ca Sekretarza),

Hanna Obarska-Pempkowiak,
Janusz Pempkowiak,
Tadeusz Piecuch
(Przewodniczący),
Jacek Piekarski
(z-ca Przewodniczącego),
Małgorzata Pilecka-Rapacz,
Wojciech Piotrowski
(z-ca Przewodniczącego),
Czesława Rosik-Dulewska,
Aleksander Szkarowski (Rosja),
(z-ca Przewodniczącego),
Kazimierz Szymański.

Redaktor Naczelny – Redaktor Naukowy

Tadeusz Piecuch

Redaktor Techniczny

Janusz Dąbrowski, Tomasz Dąbrowski

Redaktor strony internetowej <http://ros.edu.pl>

Zdzisław Knap

Recenzenci

Hubert Dębski, *Politechnika Lubelska*
Jacek Gołaszewski, *Politechnika Śląska, Gliwice*

Wydawnictwo Środkowo-Pomorskiego Towarzystwa
Naukowego Ochrony Środowiska
Koszalin tel. +48 94 3410542, +48 94 3478524 lub tel. kom. 609800439

Nakład 500 egzemplarzy, ark. wyd. 4,7, format B-5
Druk: INTRO-DRUK, Koszalin

Table of contents

1. Introduction	7
References	12
2. Used materials and research programme	14
References	34
3. Mechanical properties	37
References	57
4. Material models for concrete under impulsive load	59
4.1. Introduction	59
4.2. Plasticity based models	60
4.3. Criteria of damage for material models	61
References	66
5. Impact resistance of circular plates – experimental and numerical study	73
5.1. Experimental tests	73
5.2. Numerical analysis	79
5.3. Final remarks	85
References	86
6. Conclusions and final remarks	88
Authors' biographical notes	92

Spis treści

1. Wstęp	7
Literatura	12
2. Materiały i program badań	14
Literatura	34
3. Własności mechaniczne	37
Literatura	57
4. Modele materiałowe dla betonu pod obciążeniem impulsowym	59
4.1. Wstęp	59
4.2. Modele oparte na plastyczności	60
4.3. Kryteria uszkodzenia dla modeli materiałowych	61
Literatura	66
5. Odporność na uderzenia płyt kołowych	
– badania eksperymentalne i numeryczne	73
5.1. Testy eksperymentalne	73
5.2. Analiza numeryczna	79
5.3. Uwagi końcowe	85
Literatura	86
6. Wnioski i uwagi końcowe	88
Notki biograficzne autorów	92

1. Introduction

Concrete, mortars and other cement based composites are the most commonly applied construction materials in the world. The environmental aspects involved in the production and use of cement and concrete are of growing importance. Production of a tonne of cement (in dry process) is associated with approximately one tonne of CO₂ emissions [2]. SO₂ emission is also very high and depends upon the type of used fuel. Partial substitution of a cement by waste materials is recognized as a best way to conserve of dwindling resources helping to avoid the environmental and ecological damages caused by quarrying and exploitation of the raw materials for cement production. Partial replacement of clinker by waste materials such as: slag, fly ash, silica fume, or by natural materials that require little or no processing, such as: puzzolans and calcined clays saves energy and natural resources. The annual worldwide output of waste materials suitable as cement replacement (slags, fly ashes, silica fumes, rice husk ashes, etc.) is more than double of global cement production [2]. So far the main research effort was focused on making a cement greener almost forgetting about importance of an aggregate. Aggregate is the main component of any cement composite and covers from 60% to 80% of its volume. In total, worldwide annual production of all cement based composites consumes 20 billion tonne of different aggregate. Statistically global consumption of aggregate is equal to 3 tonne per person per year, which considerably influences natural environment, especially in fast developing countries in Asia and South America [12]. The production of commonly harnessed (in civil and structural engineering) ordinary concrete consumes large volumes of natural coarse and fine aggregate. The weight proportion of consumed coarse aggregate (e.g. gravel) and fine aggregate (e.g. sand) is approximately equal to 3:1 [14]. It is very rare that in a given location natural resources of fine and coarse aggregate are available in the needed proportion. In some areas there is excess of coarse aggregate and deficiency of fine aggregate (e.g. New Zealand), other are characterized by considerable excess of fine aggregate and deficiency of coarse aggregate [10]. Such natural conditions cause inefficient and unbalanced use of existing resources of mineral aggregate. In some cases coarse aggregate is obtained from all-in-aggregate by a hydroclassification process which consumes large quanti-

ties of water and energy, leaving waste heaps of rinsed sand. On the other hand producers of concrete are often forced to organize a long distance transport of aggregate of specific grading, which is obviously associated with a significant contribution to carbon dioxide emission. Waste ceramic aggregate can be an answer to this problem solving two urgent ecological issues at the same time: utilising large volumes of construction/demolition waste and providing locally available coarse aggregate in areas where it is in constant demand [6].

Waste materials can be used, or processed to produced materials suitable as aggregate or fillers in concrete. New grinding and mixing technology make the use of such secondary materials much simpler. Developments in chemical admixtures (superplasticizers, air-entraining agents etc.) help in controlling production techniques and in achieving the concrete characterized by the desired properties [2].

Construction and demolition wastes are usually composed of concrete rubble, bricks and other red ceramic debris, tiles, sand and dust, timber, plastics, cardboard, glass and metals. Exemplary European demolition site with ordinary demolition waste is presented in Fig.1.1. and Fig.1.2.



Fig. 1.1. Exemplary European demolition site (photo by J. Katzer)

Rys. 1.1. Przykładowa europejska rozbiórka (foto J. Katzer)



Fig. 1.2. The beginning of demolition waste processing (photo by J. Katzer)

Rys. 1.2. Początek procesu obróbki gruzu rozbiórkowego (foto J. Katzer)

Concrete and ceramic rubble usually constitute the largest volume of construction and demolition waste. It has been demonstrated that crushed concrete rubble, after separation from other waste and being sieved, can be used as a substitute for natural coarse aggregates. This type of recycled material is usually called recycled aggregate. The applications thou were limited to a concrete used as a sub-base or a base layer in pavements. Successful application of recycled aggregate in construction projects has been reported in some European and American countries, as reviewed by [4]. While this type of material has been used in large amounts in non-structural concretes or used as road bases, its use in structural concrete is limited. Only a few cases have been reported on the use of recycled aggregates in structural concrete, and the amount of recycled aggregate used has generally been limited to a low level of replacement of the total weight of coarse aggregate. An example is a viaduct and a marine lock project in the Netherlands in 1988, and an office building in the UK in 1999 [4]. In the first case, a total of 11 000 m³ of concrete in which 20% of the coarse aggregates were replaced by recycled aggregates were used in all parts of the structures. Another reported case involved the use of 4000 m³ of ready mixed concrete, which was prepared with recycled aggregates obtained from crushed concrete railway sleepers to replace 40% of the coarse aggregates [4]. It should be noted that in

these cases recycled aggregates were used only to replace the coarse natural aggregates.

Ceramic waste from construction industry (Fig.1.3) is probably the most important part in the global volume of construction and demolition waste [3].



Fig. 1.3. Ceramic waste from construction industry (photo by J. Katzer)

Rys. 1.3. Budowlany gruz ceramiczny (foto J. Katzer)

The most promising recycling process of ceramic waste is using it as a coarse aggregate for concrete. Worldwide, there is a growing research effort to successfully harness ceramic waste in construction industry [7]. It resulted so far in successful applications of ceramic waste in concrete elements characterized by less demanding mechanical characteristics, such as pavement slabs [1]. Harnessing WCA as a substitute of traditional aggregate creates a whole range of technological problems. The main issue is workability of fresh mix. WCA is characterized by very high water absorptivity which makes traditional concrete mix designing methods useless and preparation of a workable mix very tricky. Replacing traditional coarse aggregates by WCA also significantly influences the homogeneity of mechanical properties of cast concrete (populations of results are characterized by significantly higher standard deviation) and mechanical properties themselves. This phenomenon limits applications of concrete based on WCA only to elements characterized by less demanding mechanical characteristics. In order to evade these

“performance” issues one can modify concrete mix based on WCA by an addition of engineered fibre. Steel fibre proved to be a very good solution for enhancing limited mechanical properties of concretes based on other than ceramic waste aggregates [5, 9] and thus promising achieving satisfactory results in case of WCA. On the other hand the size and shape of the aggregate particles directly affects the spacing and orientation of fibres [11, 8]. The WCA (Fig. 1.4) particles are of irregular shape and in many cases look like small blades rather than sphere-like grains. Such irregularities in aggregate geometry are known to cause local fibre agglomeration (fibre balls) and non-homogeneous fibre distribution. Achieving satisfactory mechanical properties of such a composite is now out of reach, which prevents from applying it in practice.



Fig. 1.4. Ready to use waste ceramic aggregate (photo by J. Katzer)

Rys. 1.4. Gotowe do użycia ceramiczne kruszywo odpadowe (foto J. Katzer)

The objective of the planned research programme was to bypass all technological problems associated with WCA and fibre reinforcement used simultaneously. Achieved this way WCA composite would have versatile applications. Secondary structural elements, industrial floors and road pavements would be the most promising areas of implementation. The developed fresh mix should be characterized by good workability guarantying easy casting. The hardened composite should be charac-

terized by mechanical properties enabling harnessing it as a structural material without limitations. Successful merging of cement matrix based on WCA and fibre reinforcement would create new opportunities for sustainable development of construction industry. So far steel fibre proved to be a very good solution for limited mechanical properties of concrete based on other waste aggregates [9] and thus promising achieving satisfactory results in case of WCA.

References

1. **de Brito J., Pereira A.S., Correia J.R.:** *Mechanical behaviour of non-structural concrete made with recycled ceramic aggregates*. Cement and Concrete Composites. Vol. 27 (4), 429–433 (2005).
2. **Chandra S.:** *Waste Materials used in concrete manufacturing*. Standard Publishers Distributors. Delhi 2002.
3. **Correia J.R., de Brito J., Pereira A.S.:** *Effects on concrete durability of using recycled ceramic aggregates*. Materials and Structures. Vol. 39, 169–177 (2006).
4. **Desmyster J., Vyncke J.:** *Proceedings of the 1st ETNRecy, net/RILEM Workshop, on use of Recycled Materials as Aggregates in Construction Industry* (posters). Paris, ETNRecy, net, 2000.
5. **Domski J.:** *Cracking moment in steel fibre reinforced concrete beams based on waste sand*. "OVIDIUS" University Annals – Constantza, Series Civil Engineering, Year XIII (2011), Issue 13, 29-34 (2011).
6. **Domski J., Katzer J., Fajto D.:** *Load-CMOD Characteristics of Fibre Reinforced Cementitious Composites Based on Waste Ceramic Aggregate*. Annual Set - The Environment Protection, Vol. 14, 69-80 (2012).
7. **Hendriks C.F., Janssen G.M.T.:** *Use of recycled materials in construction*. Materials and Structures. Vol. 36, 604–608 (2003).
8. **Johnston C.D.:** *Fibre reinforced cements and concretes*. Gordon and Breach Science Publishers, Amsterdam 2001.
9. **Katzer J.:** *Properties of Precast SFRCC Beams Under Harmonic Load*. Science and Engineering of Composite Materials. Vol.15, No.2, 107-120 (2008).
10. **Katzer J., Kobaka J.:** *The assessment of fine aggregate pit deposits for concrete production*. Kuwait Journal of Science and Engineering. Vol. 33, 165-174 (2006).
11. **Maidl B.R.:** *Steel fibre reinforced concrete*. Ernst & Sohn. Berlin 1995.
12. **Malhorta V.M., Mehta P.K.:** *High-Performance High-Volume Fly Ash Concrete*. SCMSD Inc., second revised edition. Ottawa 2005.

13. **Müller A.:** *Lightweight aggregate produced from fine fraction of construction and demolition waste. Design for Deconstruction and Materials Re-use.* Proceedings of the CIB Task Group 39 – Deconstruction Meeting. Karlsruhe 2002.
14. **Neville A.M.:** *Properties of Concrete.* Longman, 4th Edition, Addison Wesley Longman, Harlow, Essex 1995.

2. Used materials and research programme

Waste Ceramic Aggregate

WCA was prepared on the basis of ceramic debris of construction origin. This raw ceramic waste consisted of broken and crushed wall blocks, hollow bricks and wire-cut bricks – all partially contaminated by cement mortar. This kind of ceramic debris is very common in Europe [4] and represents the waste emerging in building construction during: the very production of blocks and bricks, transportation to the building site, the execution of construction (e.g. facades, partition walls) and execution of subsequent works (e.g. opening grooves etc.) [9].

The process of preparation of WCA consisted of two main stages. During the first stage the ceramic waste was ground for 5 minutes in an electric industrial grinder. There were used 21 steel spheres characterized by mass varied from 1343 g to 2650 g [12]. As a result of grinding there was obtained a mixture of fine and coarse fractions of waste ceramic aggregate [14]. Ceramic waste and ground ceramic waste are presented in Fig. 2.1. The grading curve of coarse WCA fractions prepared with the help of rectangular sieve set (according to EN 933-1:1997) is presented in Fig. 2.2.



Fig. 2.1. Ceramic waste and ground ceramic waste [12]

Rys. 2.1. Gruz ceramiczny i zmielony gruz ceramiczny [12]

Separating fractions characterized by diameter $\phi < 1$ mm and coarser fractions ($\phi \geq 1$ mm) of ground ceramic waste was the final stage of preparation of WCA. This ground ceramic waste used as coarse aggregate is presented in Fig. 2.3. Other tested properties of WCA are summarized in Tab. 2.1.

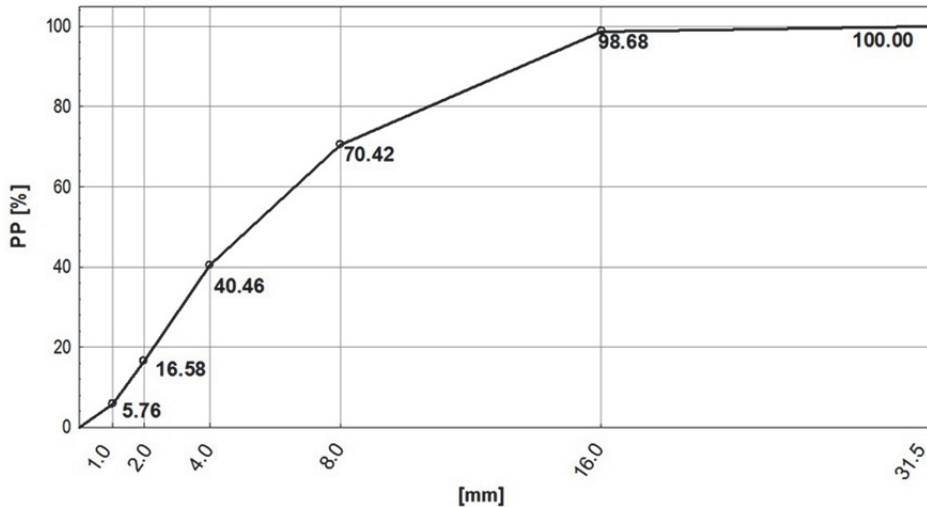

Fig. 2.2. Grading curve of harnessed WCA [11]

Rys. 2.2. Krzywa uziarnienia ceramicznego kruszywa odpadowego [11]

Table 2.1. Properties of coarse fractions of WCA

Tabela 2.1. Właściwości grubych frakcji WCA

Loose bulk density	Compacted bulk density	Water absorptivity by weight
948 kg/m ³	1170 kg/m ³	22%



Fig. 2.3. Ground ceramic waste used as coarse aggregate[11]

Rys. 2.3. Zmielony gruz ceramiczny zastosowany jako kruszywo grube [11]

Fibres

The oldest and at the same time the most basic type of steel fibres are straight fibres cut out of smooth wire. Unfortunately such fibres do not ensure a full utilization of strength of steel because of lack of appropriate anchorage in concrete matrix. Over 90% of currently produced fibres are engineered (shaped) fibres. The shape of fibres is adjusted to maximize the anchorage of fibres in concrete [10, 15, 28]. Throughout the last 50 years there have been produced twisted, crimped, flattened, spaded, coned, hooked, surface-textured and melt-cast steel fibres. These steel fibres had circular, square, rectangular or irregular cross-section. Each of the types was additionally varied by diameters and length [27]. The efficiency of the currently produced fibre is based on both its effective work in concrete matrix and the simplicity of its production which in turn has a significant influence on its price. These five most popular types of steel fibre are: traditional straight, hooked, crimped, with deformed ends (coned, with end paddles or end buttons) and with deformed wire (indented, etched or with roughened surface). Schematic geometry of the fibre mentioned above is shown in Fig. 2.4. Other types of fibre are

met relatively seldom and they are usually produced for specific orders of clients. A statistical analysis of the assortment offered by the largest fibre producers allows to claim that around 67% of sold fibre consist of the hooked type. Other most popular fibre types are: straight fibre (around 9%), fibre with deformed wire (around 9%) and crimped fibre (around 8%) [16]. The efficiency of the dispersed reinforcement depends on numerous factors. However the most important of them are aspect ratio of the used fibres influencing workability and spacing of fibres in fresh concrete mix. Because of workability of concrete mix, the aspect ratio of steel fibre should not be higher than 150.

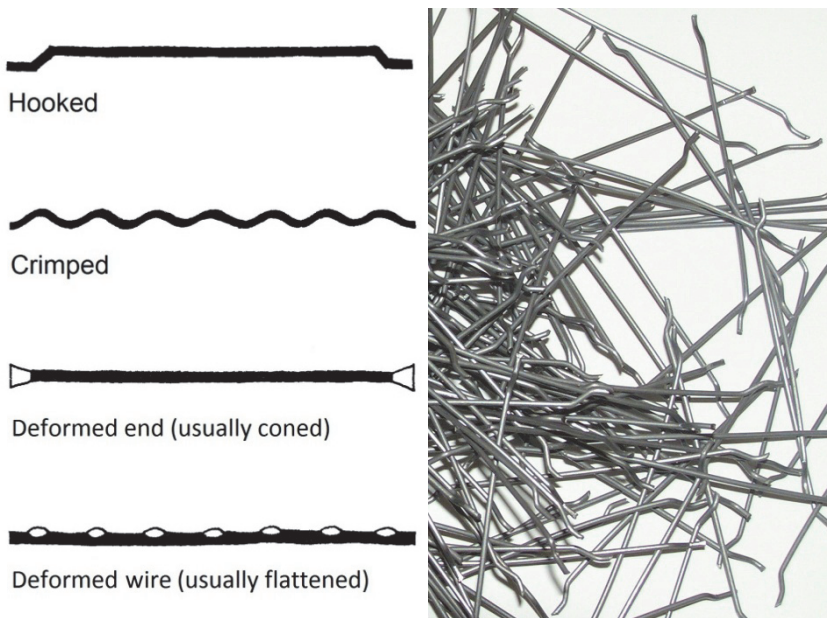

Fig. 2.4. Geometric shapes of commonly used steel fibre and an example of most popular fibre type – “hooked” [20]

Rys. 2.4. Geometryczne kształty powszechnie stosowanych włókien i przykład najbardziej popularnych włókien – „haczykowatych” [20]

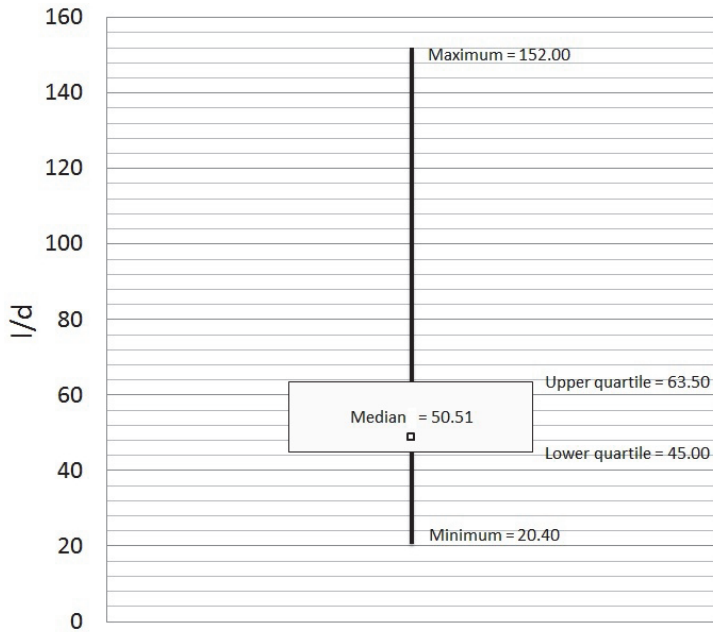

Fig. 2.5. Population of all steel fibre types offered by main producers [20]

Rys. 2.5. Rozkład wszystkich włókien oferowanych przez głównych producentów [20]

A statistical analysis of the aspect ratio of produced steel fibres is shown in Fig. 2.5 with the help of the frame chart. According to Katzer [16], the aspect ratio of fibres available on the world market ranges from 20.4 to 152, which was marked in Fig. 2.5 with the help of black lines. In order to describe the frequency of a specific fibre aspect ratio, Fig. 2.5 presents a frame showing a distance between the lower and upper quartile which is very narrow and encompasses the aspect ratio from 45 to 63.5. In other words, the aspect ratio from 45 to 63.5 constitutes 50% of the population of all types offered by producers of steel fibre used for modifying concrete. According to Naaman [28], most common steel fibres are round in cross-section, have a diameter ranging from 0.4 to 0.8 mm, and length ranging from 25 to 60 mm. The aspect ratio is generally less than 100, with a common range from 40 to 80.

Keeping all these facts in mind, three different types of hooked fibres commercially available on the European market and widely used by construction industry were chosen. The fibres were differentiated by

length, diameter, aspect ratio and producer, but at the same time representing the most commonly used fibres in Europe. Basic geometrical characteristics of all three types of fibres chosen for the research programme are summarized in Tab. 2.2. All selected fibres were made from cold drawn wire and in accordance with the basic material used for the production represent *Group I* with compliance to EN 14889-1:2006.

The first stage of quality control of chosen fibre covered measurements of geometrical dimensions of fibre such as: length, diameter, length of endings, length of a slope and angle of a hook (according to EN 14889-1:2006 and conformity declarations). A schematic diagram of measured geometrical dimensions is presented in Fig. 2.6.

Table 2.2. Basic geometric characteristics of tested fibres

Tabela 2.2. Podstawowe właściwości geometryczne zastosowanych włókien

	Fibre 1	Fibre 2	Fibre 3
l - length [mm]	60	50	50
d - diameter [mm]	0.75	0.80	1.00
l/d [-]	80.0	62.5	50.0
Producer	D	E	E
Code name	D/0.75	E/0.80	E/1.00

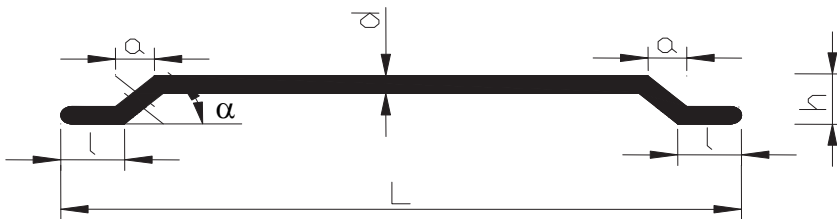

Fig. 2.6. Measured geometrical dimensions of steel fibre [20]

Rys. 2.6. Oznaczenia i geometria włókien stalowych [20]

The second stage covered tests of tensile strength of fibre. The test was performed with controlled (constant rate) increase of force (according to EN ISO 6892-1:2009). The third stage covered tests of ductility of fibre tested according to EN 10218-1:1994 (with reference to ISO 7801:1984 “Metallic materials: Wire: Reverse bend test”). The test was

performed on the end diameter before deformation. The material was bent over a cylindrical support with a radius of 1.75 or 2.5 mm (depending on fibre diameter – according to ISO 7801:1984). A schematic diagram of fibre being bent over a cylindrical support during ductility test is presented in Fig. 2.7.

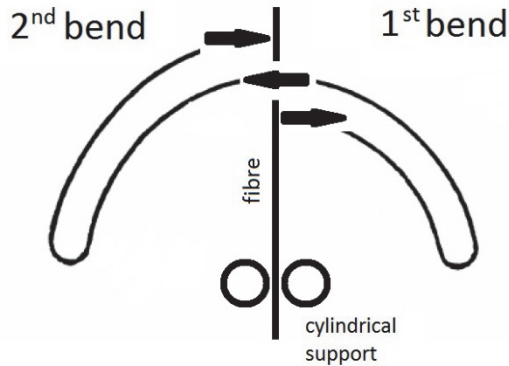

Fig. 2.7. Schematic diagram of fibre bending over a cylindrical support during the ductility test [20]

Rys. 2.7. Schemat badania przeginania włókien na cylindrycznych podporach [20]

All tests were conducted on the population of 30 randomly chosen fibres (sampling performed with the help of table of random numbers). Identification and rejection of outliers in all populations of results were performed with the help of Dixon's Q test. This test used for identification and rejection of outliers should be used no more than once in a data set. To apply a Dixon's Q test for bad data, one have to arrange the data in ascending order and calculate Q according to the equation (2.1). If $Q_{\text{calculated}} > Q_{\text{critical}}$ then the questionable point is rejected [Ellison et al. 2009, Rorabacher 1991]. The critical value corresponds to the confidence level which in case of discussed results was set at 95%.

$$Q_{\text{calculated}} = (X_2 - X_1) / (X_n - X_1) \quad (2.1)$$

where:

X_1, X_2, \dots, X_n – the set of observations under examination arranged in ascending order.

The normal (Gaussian) distribution of all populations of results were assessed using Kolmogorov–Smirnov Test (*K-S Test*). So called one-sample *K-S Test* [8, 13] was harnessed in the research study. This test is a nonparametric test for the equality of continuous, one-dimensional probability distributions which was used to compare populations of results with a reference normal probability distribution.

Fibre intrinsic efficiency ratio (*FIER*) was chosen to describe the main geometrical characteristics of chosen fibres. It has been defined as the ratio of bonded lateral surface area of fibre, to its cross sectional area [28]. In this study *FIER* was calculated for the total length L of a given fibre according to the equation (2.2).

$$FIER = (\Psi \cdot L) / A \quad (2.2)$$

where:

- Ψ - perimeter of the fibre,
- A - cross sectional area of the fibre,
- L - length of the fibre.

The cracking strength of a SFRC is primarily influenced by the strength of the matrix. The post-cracking strength is solely dependent on the fibre reinforcement parameters and the bond at the fibre-matrix interface [Naaman 2003]. *FIER* is a very useful parameter in case of evaluating post cracking strength of a SFRC. The relation between *FIER* and post-cracking strength of a SFRC is presented in the equation (2.3). Basically the higher value of *FIER* of a given fibre type, the higher the expected post-cracking strength of a SFRC.

$$\sigma_{pc} = 0.25 \cdot A \cdot \tau \cdot V_f \cdot FIER \quad (2.3)$$

where:

- A – coefficient for taking into account fibre efficiency, orientation, statistical distribution and snubbing;
- τ – bond strength at the fibre-matrix interface,
- V_f – volume fraction of fibres.

The second geometrical property analysed during this research study was characteristics of the hooked ends. Mechanical clamping of the

hook significantly increases the pull-out load as well as the pull-out energy [1, 6, 24]. In the case of ordinary and high strength concrete matrix, the hook of the fibre is straightened out during the pull-out process without any matrix failure. This straightening mechanism contributes to the pull-out resistance through plastic rotation of the fibre cross section at that location and is independent of the matrix strength and fibre embedded length. A hook contribution to pull-out resistance depends on its geometry [1] (mainly on inclination angle and hook length). Parameter $l + (a^2 + h^2)^{0.5}$ was chosen to describe hook geometry. According to several authors [5, 6, 24] fibres characterized by the highest value of parameter $l + (a^2 + h^2)^{0.5}$ should be considered as the most efficient. The results of measurements of fibre geometrical properties expressed in a form of *FIER* are presented in Fig. 2.8 and statistical characteristics of this ratio is summarized in Tab. 2.3.

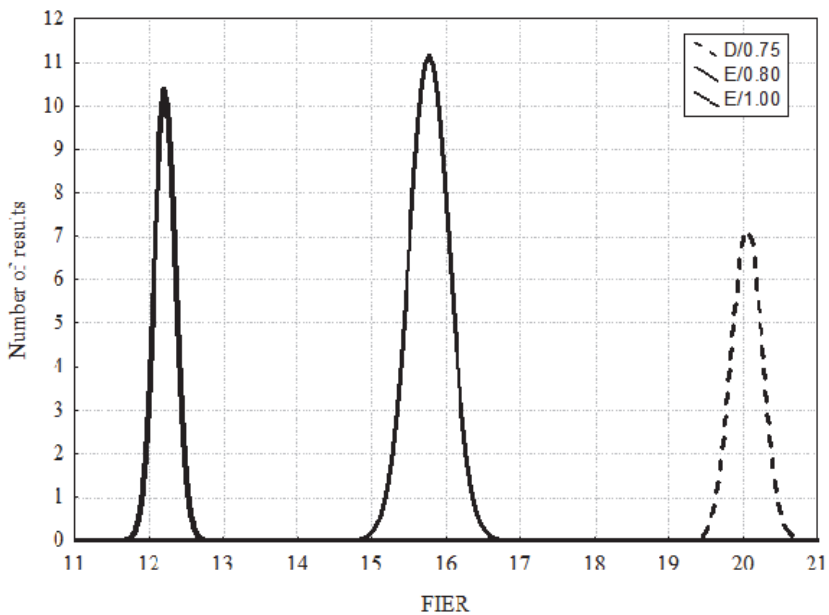

Fig. 2.8. Fibre intrinsic efficiency ratio (*FIER*) of tested fibres

Rys. 2.8. Rozkład współczynnika efektywności (*FIER*) badanych włókien

Table 2.3. Statistical characteristics of *FIER***Tabela 2.3.** Parametry statystyczne współczynnika *FIER*

	Median	Lower quartile	Upper quartile	Skewness	Kurtosis	K-S Test
D/0.75	20.065	19.870	20.230	-0.261	-0.019	0.135
E/0.80	15.812	15.687	15.875	-1.028	7.294	0.201
E/1.00	12.279	12.160	12.303	-2.119	5.666	0.237

The Median of *FIER* of tested steel fibres varied from 12.279 to 20.065. Fibre populations characterized by the highest *FIER* value were D/0.75 (*FIER* = 20.065) and this fibres should be considered as the most effective as far as *FIER* and post cracking strength of a SFRC are concerned. Fibres analysed in this study are characterized by $l + (a^2 + h^2)^{0.5}$ ranging from 5.573 to 6.266.

**Fig. 2.9.** Hook geometry**Rys. 2.9.** Rozkład wyników geometrii haczyka badanych włókien

Table 2.4. Statistical characteristics of hook geometry**Tabela 2.4.** Parametry statystyczna geometrii haczyka

	Median	Lower quartile	Upper quartile	Skewness	Kurtosis	K-S Test
D/0.75	5.753	5.505	6.034	0.277	-0.741	0.092
E/0.80	6.266	6.021	6.752	-0.034	-0.548	0.088
E/1.00	6.228	6.074	6.620	0.292	-0.229	0.101

Tensile strength of fibres is presented in Fig. 2.10 and ductility of fibres is presented in Fig. 2.11. Statistical characteristics of tensile strength and ductility distributions are summarized in Tab. 2.5 and Tab. 2.6 respectively.

**Fig. 2.10.** Tensile strength of tested steel fibres**Rys. 2.10.** Rozkład wyników wytrzymałości na rozciąganie badanych włókien

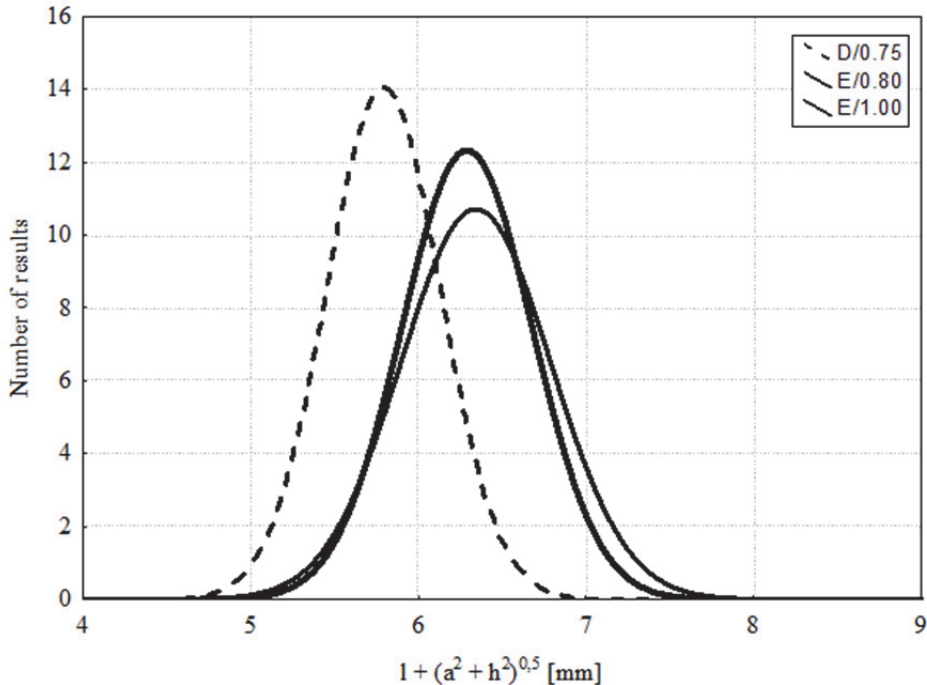
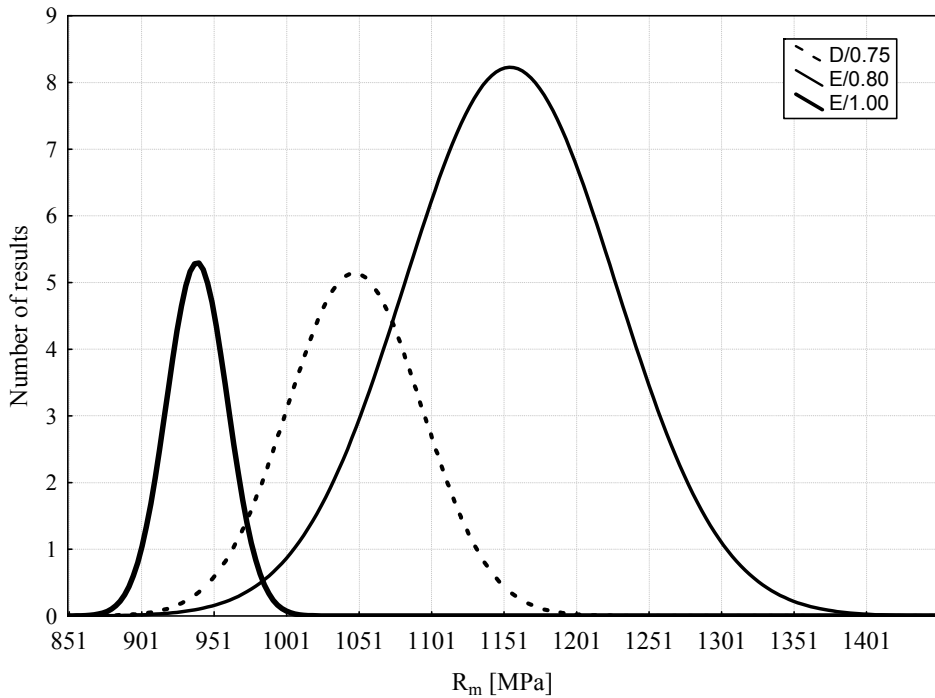
The median of tensile strength of tested steel fibres varied from 935MPa to 1147MPa. Experimental test results and theoretical analysis suggest that fibres, to be effective in concrete matrix, must be characterized by tensile strength at least two orders of magnitude higher than matrix. All steel fibres fulfil this criterion including all tested fibres. Differences in tensile strength median between tested fibre populations are of much lower magnitude and weren't chosen to compare fibre types. Instead statistical properties of result populations influencing homogeneity and uniformity of tensile strength of a given fibre population were chosen to compare them. Tested fibre populations were characterized by skewness ranging from 0.126 to 0.626 (positive skewness).

Table 2.5. Statistical characteristics of tensile strength distributions

Tabela 2.5. Parametry statystyczne wytrzymałości na rozciąganie

	Median	Lower quartile	Upper quartile	Skewness	Kurtosis	<i>K-S Test</i>
D/0.75	1040	1022	1071	0.569	0.686	0.126
E/0.80	1147	1102	1210	0.626	0.014	0.100
E/1.00	935	922	957	0.126	-0.503	0.130

The values of kurtosis ranged from -0,503 to 0.686. One population was characterized by nearly zero excess kurtosis (E/0.80) and should be considered as *mesokurtic*. From the other two populations one had negative excess kurtosis (*platykurtic*, sometimes termed *sub Gaussian*) and one had positive excess kurtosis (*leptokurtic*, sometimes termed *super Gaussian*). In the case of tensile strength *super Gaussian* distribution should be considered as the most desirable one.

Table 2.6. Statistical characteristics of ductility distributions

Tabela 2.6. Parametry statystyczne próby przeginalania

	Median	Lower quartile	Upper quartile	Skewness	Kurtosis	<i>K-S Test</i>
D/0.75	9.0	9.0	9.0	-0.660	1.395	0.333
E/0.80	7.0	7.0	8.0	0.189	0.877	0.315
E/1.00	9.0	8.0	9.0	-0.749	-0.443	0.345

The median of ductility of tested steel fibres varied from 7.0 to 9.0. Tested fibre populations were characterized by skew ranging from -0.749 to 0.189. One fibre population was characterized by positive skew and remaining two were characterized by negative skew. In case of ductility, negative skew should be considered as desirable population characteristics due to the fact that the distribution is concentrated on the right of the distribution figure (the left tail is longer) and it has relatively few low values. The fibre population with highest negative skew was E/1.00. The values of kurtosis ranged from -0.443 to 1.395. One fibre population had negative excess kurtosis (*platykurtic*, sometimes termed *sub Gaussian*) and remaining two had positive excess kurtosis (*leptokurtic*, sometimes termed *super Gaussian*). In the case of ductility *super Gaussian* distribution should be considered as the most desired one.

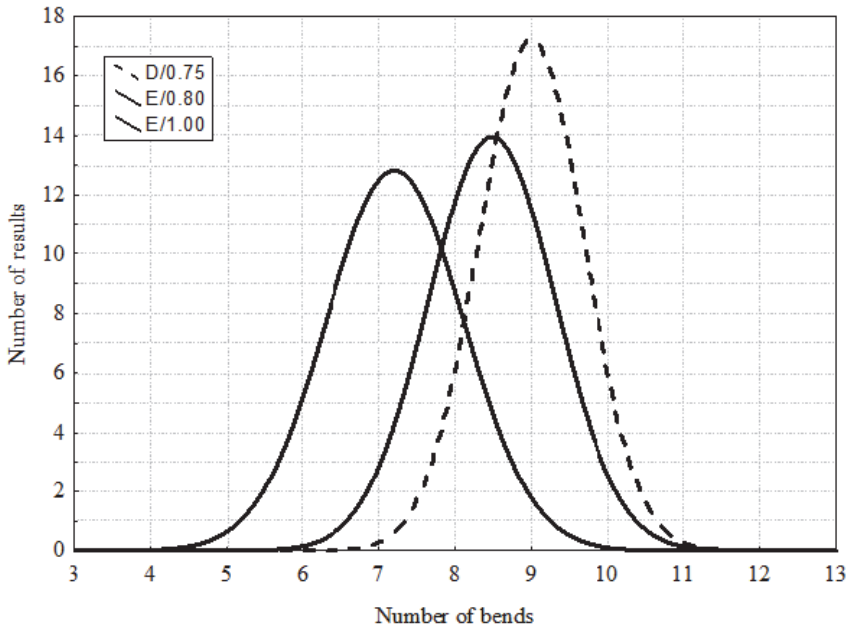

Fig. 2.11. Ductility of tested steel fibres

Rys. 2.11. Rozkład wyników przeginięcia badanych włókien

According to EN 14889-1:2006, for fibres from *Group I* (cold drawn wire), the acceptable tolerance on the declared value of R_m is 15% for individual values and 7.5% of the mean value. At least 95% of the individual specimens will have the specified tolerance. Tensile strength and ductility declared by fibre producers are presented in Tab. 2.7.

Table 2.7. Tensile strength and ductility declared by fibre producers

Table 2.7. Wytrzymałość na rozciąganie i liczba przegięć deklarowana przez producentów włókien

	Code name of fibres		
	D/0.75	E/0.80	E/1.00
Tensile strength [MPa]	≥ 1100	800–1250	
Number of bends	≥ 7		

All chosen (and tested) fibre populations showed tensile strength values in the range defined by EN 14889-1:2006. The number of bends for all specimens from D/0.75 and E/1.00 populations was higher than 7. As far as *FIER* factor is concerned, fibre type D/0.75 was characterized by the best properties. In general all three fibre populations met all code requirements and specified values. - The best overall results were achieved by fibre population D/0.75.

Water

Tap water (EN 1008:2002) was used to prepare all mixtures.

Admixture

All mixes were modified by dosage of 1% of highly effective admixture (superplasticizer type FM) containing silica fume and characterized by density equal to 1.45 g/cm^3 . This superplasticizer (and its influence on properties of the fresh mix) was described in previous work [17].

Fine aggregate

Sand of post-glacial origin (washed from all-in-aggregate during hydroclassification process) was employed as fine aggregate (Fig. 2.12). This sand and its applications in different cement composites were described in numerous previous publications [17, 22, 23].

The main mineral component of Central Pomerania aggregate is quartz and crystalline rock, dominated by granite. Figure 2.13 presents a microscope photograph of Pomeranian sand where white grains are quartz and black grains are granite. The majority of grains have an ellipsoidal shape. The rest of grains have a spherical or flaky shape. As far as smoothness of the grain surface is concerned fine aggregate is composed of rounded, subrounded and partially angular grains.



Fig. 2.12. Waste sand – a by-product of hydroclassification process of all-in-aggregate [19]

Rys. 2.12. Piasek odpadowy – produkt powstający w procesie hydroklasyfikacji kruszyw [19]

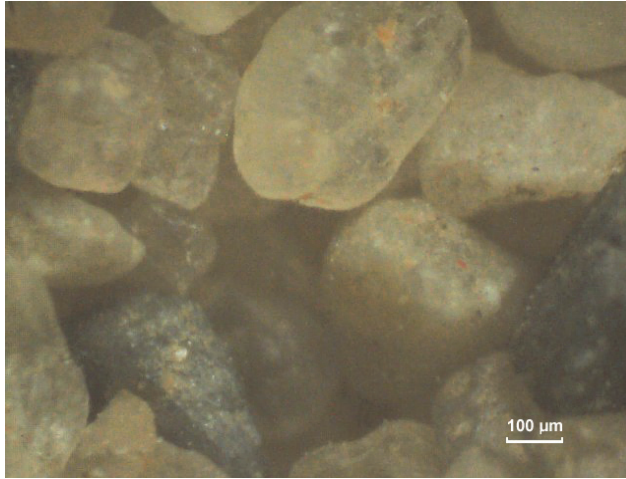

Fig. 2.13. Microscopic picture of Pomeranian fine aggregate [18]

Rys. 2.13. Obraz mikroskopowy kruszywa drobnego [18]

Binder

Portland cement CEM I 42.5 (EN 197-1:2000) was used to prepare all mixtures.

Mix Proportions

The cement matrix mix was designed with the help of so-called “double enfoldng method”. This method is focused on creating sufficient amount of cement paste enfoldng grains of fine aggregate and sufficient amount of mortar enfoldng coarse aggregate. In this way a workable but at the same time tight mix is achieved. All mechanical properties of the hardened cement composite (e.g. compressive strength) are the outcome of this tightness.

Significant absorptivity of the WCA made it impossible to apply traditional methods of concrete mix preparation. To guarantee stable properties of the fresh concrete mix, WCA was pre-saturated for 7 days in tap water. Such a long term of pre-saturating was needed to achieve full and uniform saturation of WCA. Pre-saturation, apart for enabling easy handling and mixing of fresh WCA concrete mix, allowed to benefit from internal wet curing (“autogenous curing”). The concept of internal wet curing is based on the use of internal reservoirs providing a source of water to the cement paste to offset self-desiccation phenomenon. Pre-

saturated WCA gradually releases water to replace the water used during hydration reactions. The idea that self-desiccation can be counteracted by a partial replacement of ordinary aggregate by pre-saturated porous aggregate was successfully demonstrated by various authors [26, 31, 32] and it has been proved that harnessing porous aggregate for internal curing mitigates or completely eliminates autogenous shrinkage of concrete [2, 7, 25, 33, 34]. The efficiency of an internal curing phenomenon is strongly related to both the content and the parameters of the used porous aggregate (e.g.: water absorption, pore structure, grain size distribution, volume of open and closed voids etc.). Basically the paste-aggregate proximity is a decisive factor determining the radius which the internal curing water should readily penetrate.

The theoretical mix design was scaled to accommodate water absorbed by WCA. 830kg of WCA after being fully saturated carry 182.6kg of water. Some of this water directly influences the consistency and some influences only the curing process. The amount of water was reduced to 92kg/m³. Fully saturated WCA and 92kg/m³ of water allowed maintaining stable consistency for all cast mixes. The mix design of one cubic meter is presented in Tab. 2.8.

Table 2.8. Mix proportions of one cubic meter

Tabela 2.8. Proporcje składników mieszanki na 1 m³

WCA [kg]	Sand [kg]	Cement [kg]	Water [kg]	Admixture [kg]	TOTAL [kg]
830	652	307	92	3.1	1884.1

Specimens

Specimens were in a form of cubes (150 mm · 150 mm · 150 mm), cylinders ($\phi = 150$ mm, h = 300 mm) and beams (b = 150 mm, h = 150 mm, l = 700 mm) Cubes were used for compressive strength tests and splitting tensile strength tests according to EN 12390-6:2009. Cylindrical specimens were used to test compressive strength according to EN 12390-3:2009 – Part 3 and modulus of elasticity according to ASTM C469 - Standard Test Method for Static Modulus of Elasticity and Poisson's Ratio of Concrete in Compression. Prismatic specimens were used to test flexural tensile strength according to EN 14651:2005. After the test halves of beams were used to conduct shear strength according to JCI Standards for

Test Methods of Fiber Reinforced Concrete. A rotary drum mixer was used to prepare composite mixtures. Compaction of fresh concrete mix was performed externally using a vibrating table. Each specimen was vibrated in two layers, with each layer filling half of the thickness. Each layer was vibrated for 20s (until a thin film of bleed water appeared on the surface). The first step of curing was to keep the specimens in their moulds covered with polyethylene sheets for 24h. The specimens were then removed from their moulds and cured by storing them in a water tank (Temp: +21°C) for next 27 days.

Design of experiments

The authors decided to harness one of the orthogonal designs of experiment. The choice of the design was made on the basis of previous experience of using different designs of experiment concerning fibre reinforced cement composites, which were described in previous publications [17, 21, 30]. The fibre volume was coded as X_1 and fibre aspect ratio was coded as X_2 . The object of the experiment was regarded as a complex material with an unknown structure which is unavailable for an observer and only the 'input' and 'output' parameters are known. The results of experiments were statistically processed. Values bearing the gross error were assessed on the basis of Dixon's Q test [10]. The objectivity of the carried out experiments was assured by choosing the sequence of the realization of specific experiments from a table of random numbers. All calculations associated with specifying and graphic interpretation of the received mathematical model were carried out with the help of Statistica 10.10 computer programme. All presented plots were achieved by using a polynomial fit. Fitted functions are characterized by correlation coefficient equal to at least 0.80. The chosen experiment design was described in detail in Tab. 2.9.

Table 2.9. Experiment design**Tabela 2.9.** Plan eksperymentu

Composite	Realization	X_1	X_2	V_f [%]	Code of fibres
1	7	-0.333	-1.000	0.5	D/0.75
2	6	+0.333	-1.000	1.0	D/0.75
3	8	+1.000	-1.000	1.5	D/0.75
4	4	-0.333	0.000	0.5	E/0.80
5	5	+0.333	0.000	1.0	E/0.80
6	3	+1.000	0.000	1.5	E/0.80
7	1	-0.333	+1.000	0.5	E/1.00
8	9	+0.333	+1.000	1.0	E/1.00
9	10	+1.000	+1.000	1.5	E/1.00
10	2	-1.000	-1.000	0.0	D/0.75
11	2	-1.000	0.000	0.0	E/0.80
12	2	-1.000	+1.000	0.0	E/1.00
Kompozyty nr 11 i 12 odpowiadają nr 10 - z uwagi na $V_f = 0.0\%$					

Research Programme

The research programme was organized in two main stages. The objective of the first stage was to determine the workability of fresh mix, density, compressive strength and modulus of elasticity of the composites in question. Measurement of workability was conducted according to Vebe procedure. This testing method was chosen because it is well suited for FRCC mixes [17]. Moreover, the treatment of concrete during the test is comparatively closely related to the method of placing *in situ* [29].

The second stage of the research involved measuring the flexural tensile strength according to the limit of proportionality (LOP) method (EN 14651:2005). The three-point flexural test was chosen as the most adequate for the research programme. In case of three-point test, beam is formed with a notch (5 mm wide, 25 mm deep) and the first crack always appears in the vicinity of the mid-span. In case of four-point test the test beam is formed without a notch and the first crack appears at the weakest cross section and the location of the crack cannot be predicted. During the flexural test the deflection and the crack mouth opening displacement (CMOD) were measured for all beams. For evaluating the residual tensile strength (f_R), the responses of the FRCC beams at CMOD 0.5 mm, 1.5

mm, 2.5 mm and 3.5 mm were of special interest. The loading rate was equal to 0.05 mm/min until achieving $CMOD = 0.1$ mm. Further on the loading rate was equal to 0.2 mm/min. Both load-CMOD and load-deflection curves were estimated.

The examination results were statistically processed, and values bearing the gross error were assessed on the basis of Grubbs criterion [3]. The objectivity of the experiments was assured by the choice of the sequence of the realization of specific experiments from a table of random numbers.

Cross-sections of all tested beams were analysed. The uniformity of WCA spacing was assessed. In Fig. 2.14 an exemplary cross-section of FRCC beam is presented. The area of WCA was graphically separated and counted. On average the WCA was representing $58\% \pm 2\%$ of total cross-section area.

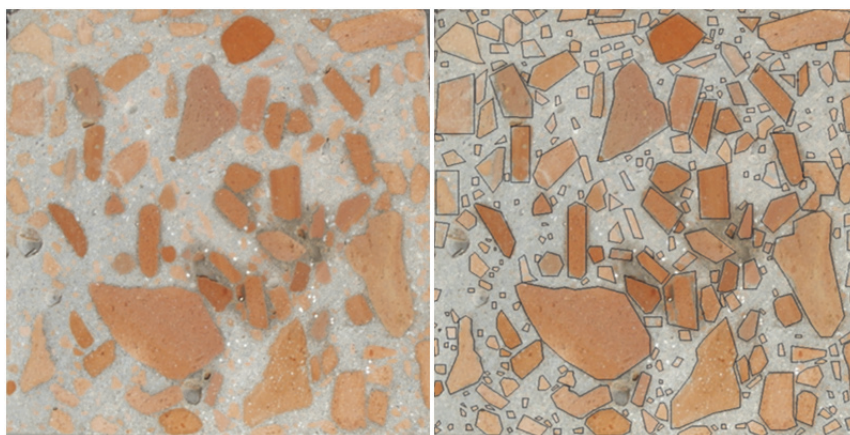

Fig. 2.14. Cross-section of a WCA cement matrix
(left – plain, right – with graphically separated WCA)

Rys. 2.14. Przekrój matrycy cementowej WCA
(z lewej – zwykły, z prawej – z graficznym zaznaczeniem WCA)

References

1. **Alwan J.M. et al.:** *Effect of mechanical clamping on the pull-out response of hooked steel fibres embedded in cementitious matrices.* Concrete Science and Engineering, Vol.1, 15-25 (1999).
2. **Bentur A., Igarashi S., Kovler K.:** *Prevention of autogenous shrinkage in high strength concrete by internal curing using wet lightweight aggregates.* Cement and Concrete Research 31 (11), 1587–1591 (2001).
3. **Borovikov I.P., Borovikov V.P.:** *STATISTICA: Data Preparation and Analysis.* Filini. Moscow (1998).
4. **de Brito J., Pereira A.S., Correia J.R.:** *Mechanical behaviour of non-structural concrete made with recycled ceramic aggregates.* Cement and Concrete Composites. Vol. 27 (4), 429–433 (2005).
5. **Cailleux E., Cutard T., Bernhart G.:** *Pullout of steel fibres from a refractory castable, experiment and modelling.* Mech Mater 37, 427–445, (2005);
6. **Chanvillard G.:** *Modeling the pullout of wire-drawn steel fibers.* Cem Concr Res 29,1027–1037, (1999).
7. **Collins F., Sanjayan J.G.:** (1999) *Strength and shrinkage properties of alkali-activated slag concrete containing porous coarse aggregate.* Cement and Concrete Research. Vol. 29 (4), 607–610 (1999).
8. **Corder G.W., Foreman D.I.:** *Nonparametric Statistics for Non-Statisticians: A Step-by-Step Approach.* Wiley, New Jersey, USA (2009).
9. **Correia J.R., de Brito J., Pereira A.S.:** *Effects on concrete durability of using recycled ceramic aggregates.* Materials and Structures. Vol. 39, 169–177 (2006).
10. **Domski J.:** *Cracking moment in steel fibre reinforced concrete beams based on waste sand.* “OVIDIUS” University Annals – Constantza, Series Civil Engineering, Year XIII (2011), Issue 13, 29-34 (2011).
11. **Domski J., Katzer J.:** *Load-deflection Characteristic of Fibre Concrete Based on Waste Ceramic Aggregate.* Annual Set - The Environment Protection, Vol. 15, 69-80 (2013).
12. **Domski J., Katzer J., Fajto D.:** *Load-CMOD Characteristics of Fibre Reinforced Cementitious Composites Based on Waste Ceramic Aggregate.* Annual Set - The Environment Protection, Vol. 14, 69-80 (2012).
13. **Eadie W.T.:** *Statistical methods in experimental physics.* North-Holland, USA 1988.
14. **Gawenda T.:** *Wpływ rozdrabniania surowców skalnych w różnych kruszarkach i stadiach kruszenia na jakość kruszyw mineralnych, Gospodarka Surowcami Mineralnymi, vol. 29 (1), year 2013, 53-65. DOI 10.2478/gospo-2013-0002*

15. **Johnston C.D.:** *Fibre reinforced cements and concretes*. Gordon and Breach Science Publishers, Amsterdam 2001.
16. **Katzer J.:** *Steel fibers and steel fiber reinforced concrete in civil engineering*. Pacific Journal of Science and Technology. Vol.7, No.1, 53-58 (2006).
17. **Katzer J.:** *Properties of Precast SFRC Beams Under Harmonic Load*. Science and Engineering of Composite Materials. Vol.15, No.2, 107-120 (2008).
18. **Katzer J.:** *Median diameter as a grading characteristic for fine aggregate cement composite designing*. Construction and Building Materials, Vol. 35, 884–887 (2012).
19. **Katzer J.:** *Strength performance comparison of mortars made with waste fine aggregate and ceramic fume*. Construction and Building Materials, Vol. 47, 1-6 (2013).
20. **Katzer J., Domski J.:** *Quality and mechanical properties of engineered steel fibres used as reinforcement for concrete*. Construction and Building Materials, Vol. 34, 243–248 (2012).
21. **Katzer J., Domski J.:** *Optimization of fibre reinforcement for waste aggregate cement composite*. Construction and Building Materials. Vol. 38, 790–795 (2013).
22. **Katzer J., Kobaka J.:** *Ultrasonic pulse velocity test of SFRC*. Proceedings, The 2nd Central European Congress on Concrete Engineering “Concrete Structures for Traffic Network”, 21-22 September 2006, Hradec Kralove, Czech Republic, 389-392 (2006).
23. **Katzer J., Kobaka, J.:** *Harnessing Waste Fine Aggregate for Sustainable Production of Concrete Precast Elements*. Annual Set - The Environment Protection. Vol. 12, 33-45 (2010).
24. **Kim D.J. et al.:** *Loading Rate Effect on Pullout Behavior of Deformed Steel Fibers*. ACI Materials Journal, Vol. 106, 576-584 (2008).
25. **Kohno K., et al.:** *Effects of artificial lightweight aggregate on autogenous shrinkage of concrete*. Cement and Concrete Research. Vol. 29 (2), 611–614 (1999).
26. **Kovler K., Jensen O.M.:** *Novel techniques for concrete curing*. Concrete International. Vol. 27 (9), 39–42 (2005).
27. **Maidl B.R.:** *Steel fibre reinforced concrete*. Ernst & Sohn. Berlin 1995.
28. **Naaman A.E.:** *Engineered Steel Fibres with Optimal Properties for Reinforcement of Cement Composites*. Journal of Advanced Concrete Technology, Vol.1 (3), 241-252 (2003).
29. **Neville A.M.:** *Properties of Concrete*. Longman, 4th Edition, Addison Wesley Longman, Harlow, Essex 1995.

30. **Ponikiewski T., Katzer J.:** *Mechanical characteristics of green SCC modified by steel and polymer fibres.* Annual Set - The Environment Protection, Vol. 16, (2014).
31. **Suzuki M., Meddah M.S., Sato R.:** *Use of porous ceramic waste aggregates for internal curing of high-performance concrete.* Cement and Concrete Research. Vol. 39, 373–381 (2009).
32. **Weber S., Reinhardt H.W.:** *A new generation of high performance concrete: concrete with autogenous curing.* Advanced Cement Based Material. Vol. 6 (2), 59–68 (1997).
33. **Zhutovsky S., Kovler K., Bentur A.:** *Influence of wet lightweight aggregate on mechanical properties of concrete at early ages.* Materials Structure. Vol. 35, 97–101 (2002).
34. **Zhutovsky S., Kovler K., Bentur A.:** *Influence of cement paste matrix properties on the autogenous curing of high-performance concrete.* Cement & Concrete Composites. Vol. 26 (5), 499–507 (2004).

3. Mechanical properties

Mechanical properties of composites in question, tested in a traditional static way are shown in this chapter. The graphic representation of the results are presented in a form of 3D-column charts with one axis denominated with fibre volume V_f and second axis denominated with fibre type (directly associated with its aspect ratio). The third axis is denominated in units of tested property. To make all figures easier to read and analyse they were scaled in the same manner throughout the chapter. Results achieved for the matrix form the bottom surfaces of all the charts. In this way all differences between any given composite and matrix are easy to spot and understand.

In Fig 3.1 density of hardened composites is presented. The test was conducted according to EN 12390-7. Matrix was characterized by the density equal to 2001 kg/m^3 .

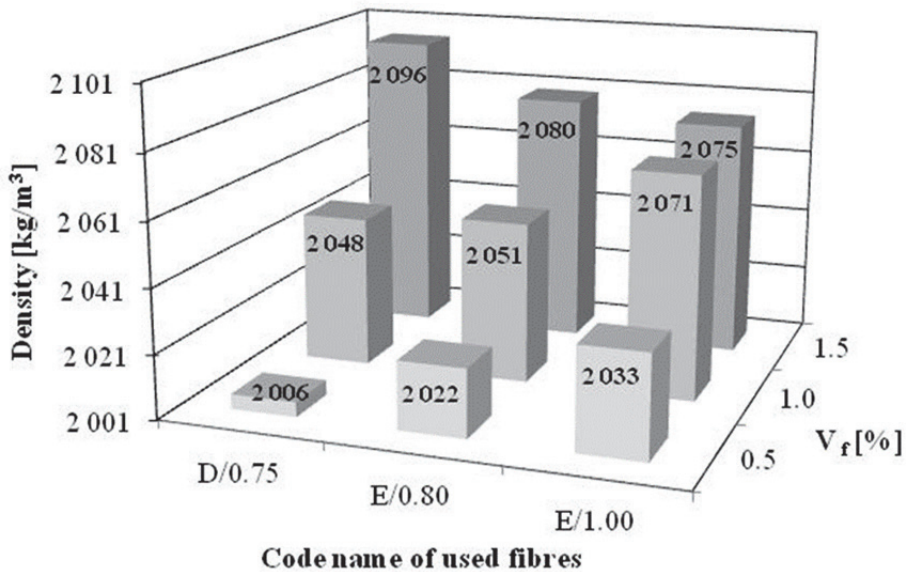

Fig. 3.1. Density of hardened composites

Rys. 3.1. Gęstość stwardniałych kompozytów

The density of composites modified by fibre varied from 2006 kg/m³ (for D/0.75 and V_f = 0.5%) to 2096 kg/m³ (for D/0.75 and V_f = 1.5%). In general density gets larger along the increasing volume of added fibre. Composites modified by fibre D/0.75 are characterized by the largest differences in density (2096 kg/m³ - 2006 kg/m³ = 90 kg/m³). Composites modified by E/1.00 fibre are characterized by smallest differences in density (2075 kg/m³ - 2033 kg/m³ = 42 kg/m³). Achieved results are similar to these from previous research programmes and described by multiple researchers [3, 4]. Statistical characteristics of the results is summarized in Tab. 3.1.

Table 3.1. Statistical description of results for density

Tabela 3.1. Statystyczny opis wyników gęstości

Composite symbol	Density [kg/m ³]	Standard deviation [kg/m ³]	Volatility ratio [%]
1	2006	29.29	1.46
2	2048	28.36	1.38
3	2096	32.58	1.55
4	2022	21.14	1.05
5	2051	31.58	1.54
6	2080	23.19	1.12
7	2033	23.74	1.17
8	2071	20.10	0.97
9	2075	23.28	1.12
10	2001	23.14	1.16

Compressive strength was tested on cube specimens (150 mm x 150 mm x 150 mm). The setting of a specimen during compressive strength is presented in Fig. 3.2. The test was conducted according to EN 12390-3. Results for compressive strength are presented in Fig. 3.3. The matrix was characterized by compressive strength equal to 39.14 MPa. In case of fibre composites, the highest compressive strength was achieved by composite no 6 (53.34 MPa) and the smallest one by composite no 1 (43.74 MPa).



Fig. 3.2. Cube specimen prepared for compressive strength test (photo by J. Katzer)

Rys. 3.2. Próbką sześcienną przygotowaną do badania wytrzymałości na ściskanie (foto J. Katzer)

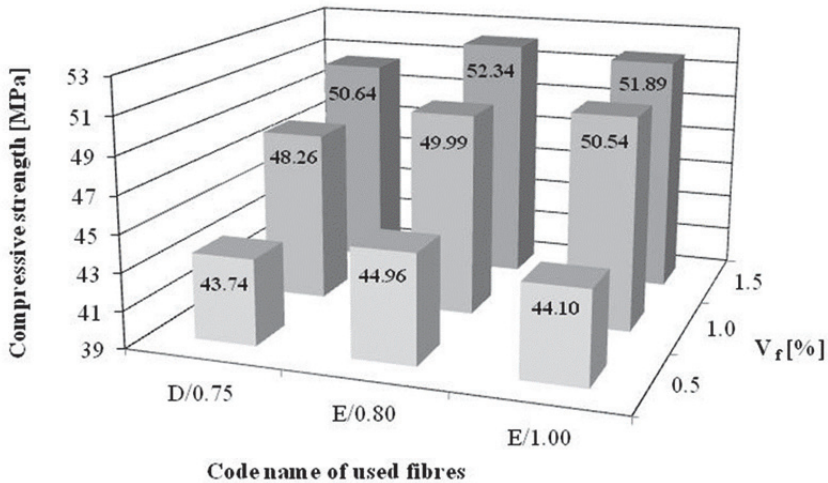

Fig. 3.3. Compressive strength tested on cubes 150 mm x 150 mm x 150 mm

Rys. 3.3. Wytrzymałość na ściskanie zbadana na kostkach 150 mm x 150 mm x 150 mm

It means that in comparison to the matrix, addition of fibre allowed to increase the compressive strength from 11.75% to 33.72%. The addition of E/0.80 fibre gave the best results in this case. Composite

modified by 0.5% of this fibre was characterized by the highest compressive strength comparing to other composites with 0.5% fibre addition. Composite modified by 1.5% of this fibre was also characterized by the highest compressive strength comparing to other composites with 1.5% fibre addition. General compressive strength characteristic of tested composites is similar to these achieved by other researchers who tested cement composites based on waste materials [1, 17, 20, 21]. Statistical characteristics of the results of compressive strength are summarized in Tab. 3.2.

Table 3.2. Statistical description of results for compressive strength

Tabela 3.2. Statystyczny opis wyników wytrzymałości na ściskanie

Composite symbol	Compressive strength [MPa]	Standard deviation [MPa]	Volatility ratio [%]
1	43.74	4.03	9.22
2	48.26	4.03	8.35
3	50.64	2.92	5.76
4	44.96	6.60	14.67
5	49.99	5.24	10.48
6	52.34	5.09	9.73
7	44.10	5.44	12.34
8	50.54	6.34	12.55
9	51.89	7.34	14.14
10	39.14	6.71	17.14

Tensile splitting test originally design for ordinary concrete (EN 12390-6) is often successfully used for fibre composite testing. This test is simple to perform and gives more uniform results than other tension tests [15]. There were used cube 150 mm x 150 mm x 150 mm as specimens to conduct this test. In the test a specimen is placed between the platens of a testing machine and the load is being applied through loading pieces (in a shape of crescents) resting against a cube on centre lines of two opposing faces (Fig. 3.4).



Fig. 3.4. Cube specimen after splitting tensile test (photo by J. Domski)
Rys. 3.4. Próbką sześcienna po badaniu wytrzymałości na rozciąganie przy rozłupywaniu (foto J. Domski)

The load is applied continuously at a constant rate until failure (by indirect tension in the form of splitting along the vertical dimension) takes place. This test is covered by EN 14651. The achieved results of testing the composites in question are presented in Fig. 3.5.

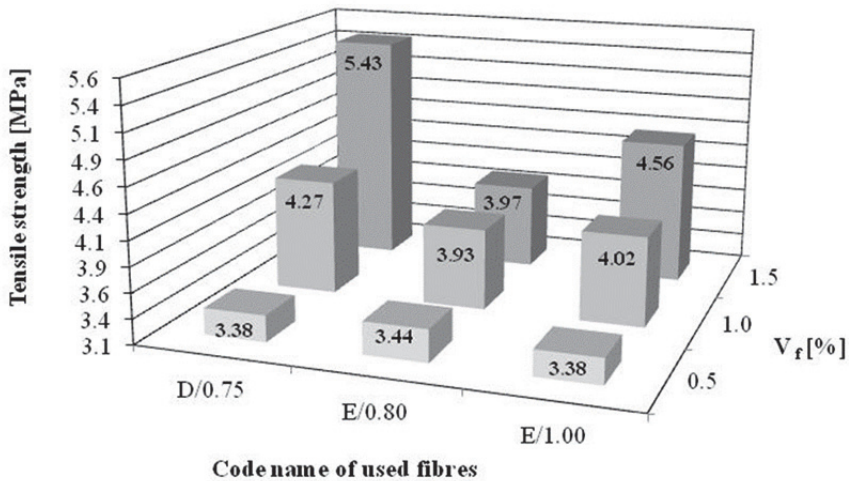

Fig. 3.5. Tensile splitting strength
Rys. 3.5. Wytrzymałość na rozciąganie przy rozłupywaniu

The matrix was characterized by tensile splitting strength equal to 3.12 MPa. In case of fibre reinforced composites the strength varied from 3.38 MPa to 5.43 MPa. The highest tensile splitting strength was achieved by composite no 3 (increase of 74% in comparison to the matrix). All three fibre composites modified by 0.5% of fibre (composite no 1, 4 & 7) are characterized by almost the same tensile splitting strength equal to 3.38 MPa, 3.44 MPa and 3.38 MPa respectively. These strengths are only about 0.3 MPa bigger than strength of the matrix. Statistical characteristics of the results of tensile splitting strength are summarized in Tab.3.3.

Table 3.3. Statistical description of results for tensile splitting strength
Tabela 3.3. Statystyczny opis wyników wytrzymałości na rozciąganie przy rozłupywaniu

Composite symbol	Tensile strength [MPa]	Standard deviation [MPa]	Volatility ratio [%]
1	3.38	0.76	22.43
2	4.27	1.19	27.77
3	5.43	1.44	26.56
4	3.44	0.57	16.49
5	3.93	0.69	17.49
6	3.97	0.20	5.05
7	3.38	0.41	12.27
8	4.02	0.92	22.98
9	4.56	1.30	28.58
10	3.12	0.59	18.96

Shear strength was tested according to JCI-SF6. There were used prism specimens (half-beams leftovers after flexural tests) which were loaded using shear apparatus as shown in Fig. 3.6. During the test, load acts perpendicularly on the specimen at all times. Loading was applied to the specimen continuously without impact. The rate of loading was such that the increase in shear stress was from 0.06 MPa to 0.1 MPa.

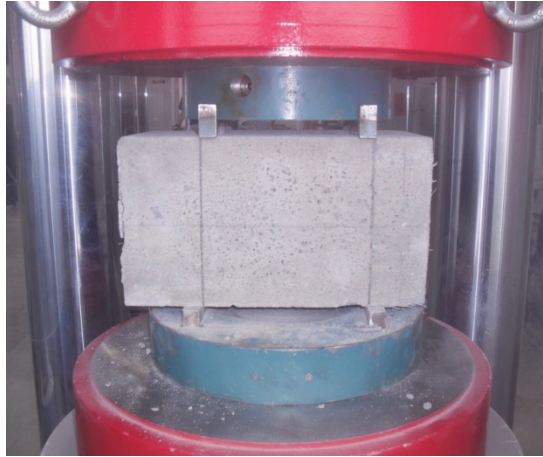

Fig. 3.6. Prism specimen prepared for shear test (photo by J. Domski)

Rys. 3.6. Próbkę równoległościenną przygotowaną do badania wytrzymałości na ścinanie (foto J. Domski)

The results of shear test are presented in Fig. 3.7. Matrix is characterized by shear strength of 4.97 MPa. Shear strength of fibre composites ranges from 7.18 MPa (composite 7) to 11.58 MPa (composite 3).

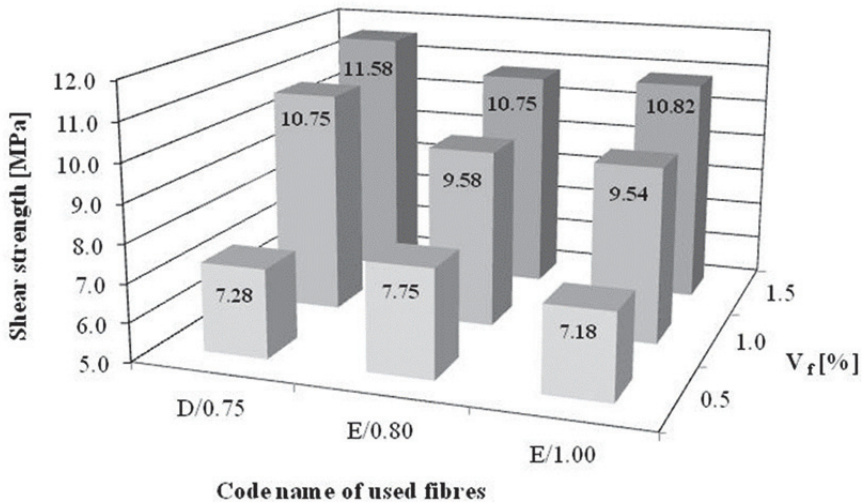

Fig. 3.7. Shear strength

Rys. 3.7. Wytrzymałość na ścinanie

There is a significant increase (up to 133%) in the shear strength transferred through the effect of fibre. This increase in shear strength can be explained by higher ultimate tensile strength of fibre composites comparing to matrix and by reduction in crack width which gives rise to an improvement in the shear transmission between the sides of the crack [13]. Statistical characteristics of the results of shear strength are summarized in Tab. 3.4.

Table 3.4. Statistical description of results for shear strength

Tabela 3.4. Statystyczny opis wyników wytrzymałości na ścinanie

Composite symbol	Shear strength [MPa]	Standard deviation [MPa]	Volatility ratio [%]
1	7.28	1.14	15.60
2	10.75	1.06	9.83
3	11.58	1.96	16.97
4	7.75	0.95	12.31
5	9.58	1.15	11.97
6	10.75	0.20	1.83
7	7.18	1.65	22.94
8	9.54	1.13	11.88
9	10.82	0.64	5.93
10	4.97	0.95	19.18

The flexural tensile strength was tested according to the limit of proportionality (LOP) method (EN 14651). The three-point flexural test was chosen as the most reliable one in comparison to four-point tests (Fig. 3.8). In case of three-point test, beam is formed with a notch and the first crack always appears in the vicinity of the mid-span. In case of four-point test the test beam is formed without a notch and the first crack appears at the weakest cross section and the location of the crack cannot be predicted. The crack mouth opening displacement (CMOD) was measured for all tested beams.

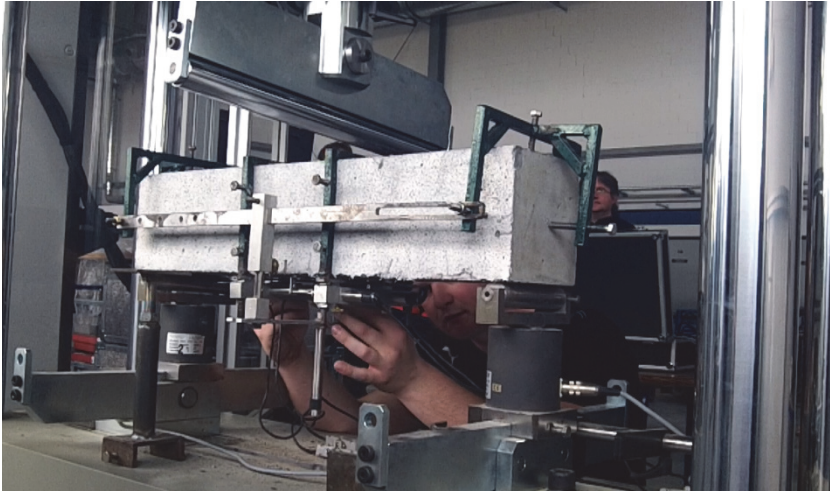

Fig. 3.8. Prism specimen (150 mm x 150 mm x 750 mm) prepared for testing according to EN-14651

Rys. 3.8. Próbka (150 mm x 150 mm x 750 mm) przygotowana do badań według EN-14651

In the case of evaluating the residual tensile strength (f_R), the responses of the fibre reinforced cement composite beams at CMOD 0.5 mm, 1.5 mm, 2.5 mm and 3.5 mm were of special interest. The loading rate was equal to 0.2 mm/min and load-CMOD curves were measured. The examination results were statistically processed, and values bearing the gross error were assessed on the basis of Grabb's criterion [2]. The objectivity of the experiments was assured by the choice of the sequence of the realization of specific experiments from a table of random numbers. This testing procedure was thoroughly described in previous publications [4, 20].

The load-deflection response of fibre composite under different types of stress reveals the extent of the influence of the steel fibre addition (Fig 3.9–3.11). The matrix is brittle and very easy to capsize. On contrary fibre composite after the maximum load has been exceeded and deformation is increasing, the load-bearing capacity is in no way exhausted [13]. This property is usually described using toughness which corresponds to the area under the load-deflection curve.

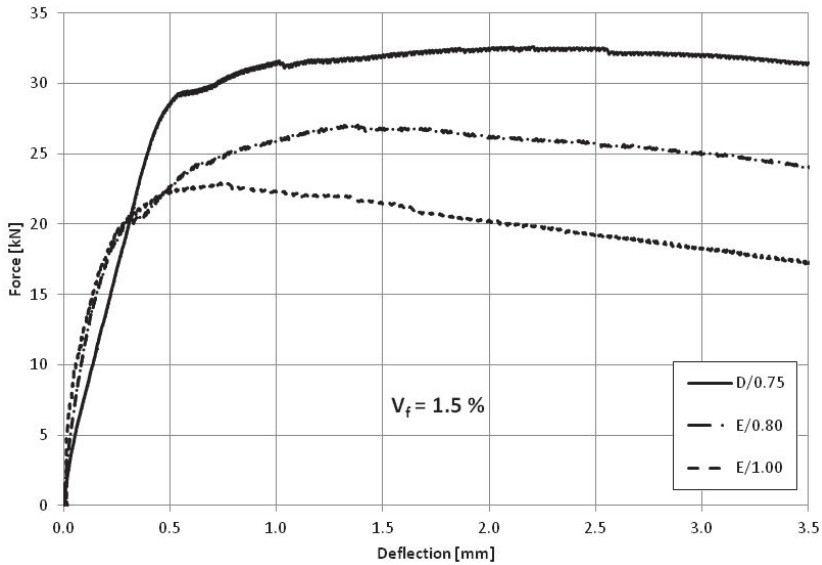

Fig. 3.9. Force – deflection relationships for prism specimens modified by 1.5% of fibre

Rys. 3.9. Zależności siła – ugięcie dla belek z dodatkiem 1,5% włókien

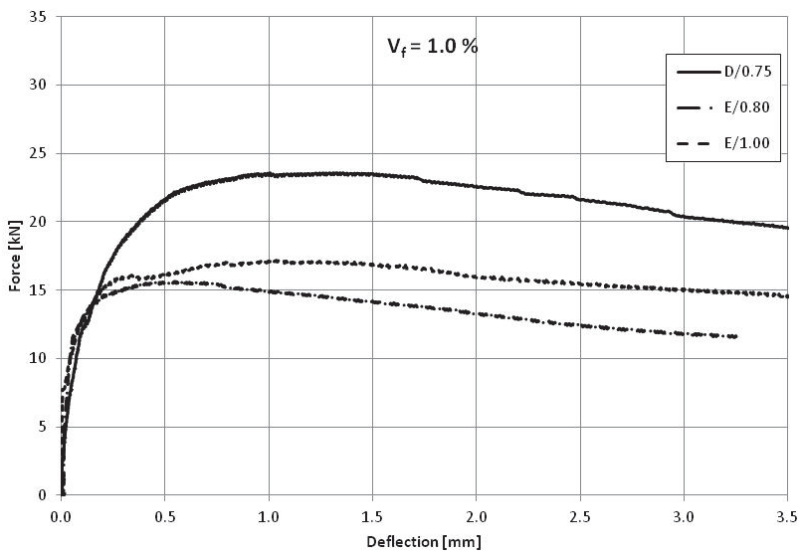

Fig. 3.10. Force – deflection relationships for prism specimens modified by 1.0% of fibre

Rys. 3.10. Zależności siła – ugięcie dla belek z dodatkiem 1,0% włókien

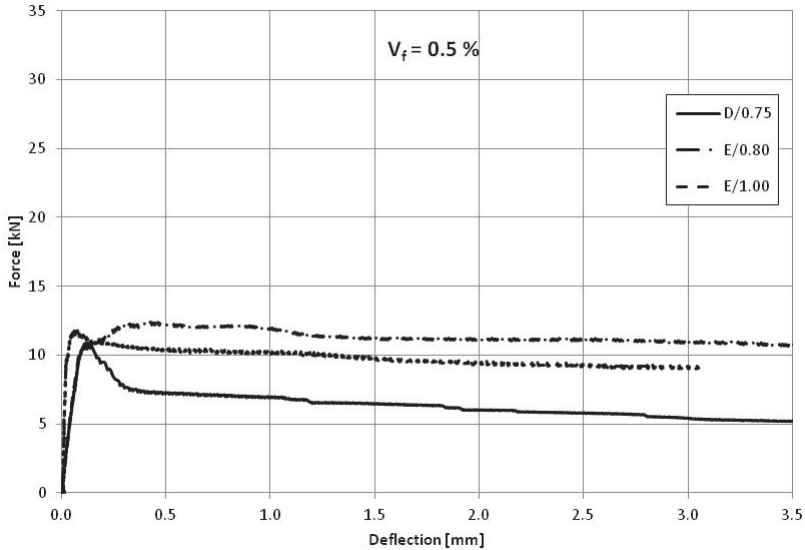

Fig. 3.11. Force – deflection relationships for prism specimens modified by 0.5% of fibre

Rys. 3.11. Zależności siła – ugięcie dla belek z dodatkiem 0,5% włókien

During the research programme flexural toughness was understood as total energy absorbed in breaking a specimen in flexure. This is probably the most important mechanical property of fibre reinforced cement composites. Flexural toughness although contested by some researchers is very useful to evaluate the resistance of the fibre composites under dynamic loadings (impact, harmonic, fatigue) [12, 13, 14, 19]. Even minimal fibre addition, which has no statistically valid influence on mechanical properties of a composite can influence its toughness. On the basis of force – deflection relationships achieved during the research programme there were calculated two measurements of toughness. The first was based on the area up to maximum load, the second was based on the area up to a specified end-point deflection equal to 3.44 mm. The flexural toughness calculated in these ways was presented in Fig.3.12 and 3.13 respectively. These properties are very important for fatigue resistance and cracking mechanism of fibre cement composites [9, 16, 17].

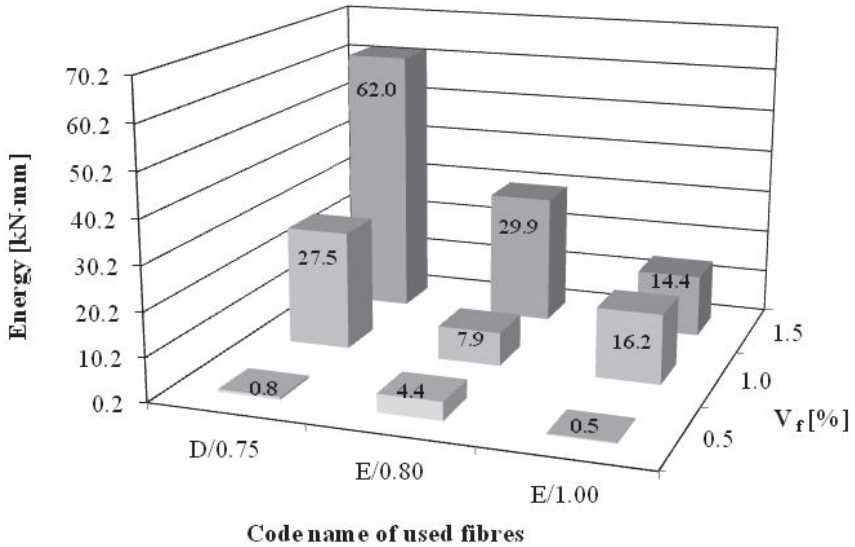

Fig. 3.12. Flexural toughness calculated for maximum value of loading force
Rys. 3.12. Energia (pole pod wykresem siła-ugięcie) potrzebna do osiągnięcia maksymalnej siły

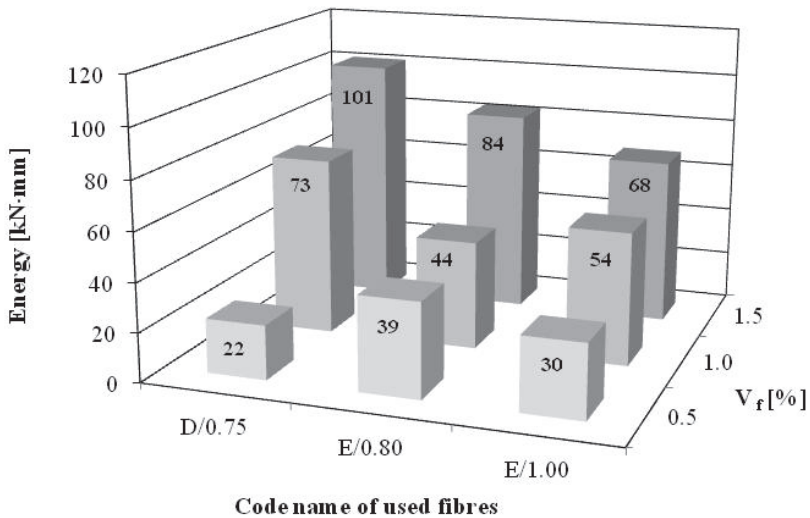

Fig. 3.13. Flexural toughness calculated for deflection equal to 3.44 mm
Rys. 3.13. Energia (pole pod wykresem siła-ugięcie) potrzebna do osiągnięcia ugięcia 3,44 mm

Compressive strength tested on cylinder specimens (according to EN 12390-3) is essential to establish the values of modulus of elasticity. The mean value of the compressive strength, determines the stress applied in the determination of static modulus of elasticity. Cylinder specimen prepared for compressive strength test is presented in Fig.3.14. Achieved results of compressive strength tested on cylinder specimens are presented in Fig. 3.15. Matrix is characterized by compressive strength equal to 27.9 MPa. The strength of fibre composites varies from 29.5 MPa for composite no 7 to 36.3 MPa for composites 6 and 9. The maximum compressive stress which can be absorbed by fibre composites is only slightly greater than that of the matrix. Increases in strength tested on cylinders remain in the range of 5.7% to 30.1%. Similar results were obtained by multiple researchers in previous research programmes [12, 13, 14]. Statistical description of results for compressive strength tested on cylinders is summarized in Tab.3.5.



Fig. 3.14. Cylinder specimen prepared for compressive strength test (photo by J. Domski)

Rys. 3.14. Próbkę walcową przygotowaną do badania wytrzymałości na ściskanie (foto J. Domski)

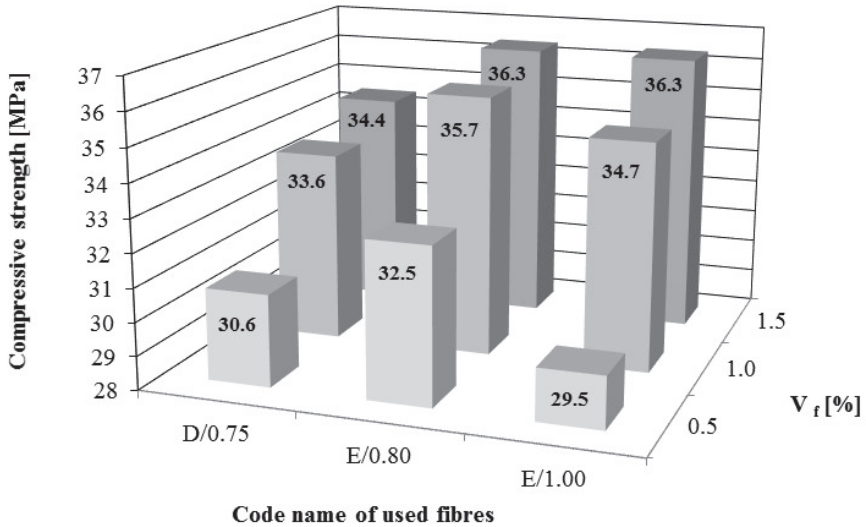

Fig. 3.15. Compressive strength tested on cylinders ($\varphi = 150$ mm, $h = 300$ mm)

Rys. 3.15. Wytrzymałość na ściskanie zbadana na walcach ($\varphi = 150$ mm, $h = 300$ mm)

Table 3.5. Statistical description of results for compressive strength tested on cylinders

Tabela 3.5. Statystyczny opis wyników wytrzymałości na ściskanie zbadanej na cylindrach

Composite symbol	Compressive strength [MPa]	Standard deviation [MPa]	Volatility ratio [%]
1	30.6	3.37	10.98
2	33.6	3.91	11.63
3	34.4	3.52	10.25
4	32.5	2.41	7.41
5	35.7	3.46	9.69
6	36.3	3.32	9.14
7	29.5	3.26	11.09
8	34.7	4.00	11.51
9	36.3	3.02	8.32
10	27.9	4.13	14.79

It is commonly known that inclusion of steel fibre in cement matrix has a little effect on the modulus of elasticity [12, 13, 14]. Nevertheless due to non-conventional matrix the tests of the modulus of elasticity for all composites in question were conducted.

Static modulus of elasticity in compression E (also known as the secant modulus or chord modulus), is calculated from the following formula:

$$E_c = \Delta\sigma/\Delta\varepsilon \text{ [N/mm}^2\text{]} \quad (3.1)$$

where $\Delta\sigma/\Delta\varepsilon$ and $\Delta\sigma/\Delta\varepsilon$ are the differences in stress and strain, respectively, between a basic loading level of 0.5 N/mm^2 and an upper loading level of one-thirds of the compressive strength of the concrete (tested on cylinder specimens). The test is based on steadily increasing the stress at a rate of $0,6 \pm 0,4 \text{ N/mm}^2$ per second until the stress equal to one-third of the compressive strength of the concrete is reached. The stress is then maintained for 60 seconds (a record of the strain readings is taken at this time). The load is reduce, at the same rate as during loading, to the level of the basic stress of 0.5 N/mm^2 . There are carried out at least two additional preloading cycles, using the same loading and unloading rate, and maintaining the stress (σ_a , and σ_b) constant for a period of 60 s. After completion of the last preloading cycle and a waiting period of 60 s under the stress $\sigma_b = 0,5 \text{ N/mm}^2$, recording the strain readings ε_b takas place. The specimen than is reloaded to stress σ_a at the specified rate, and recording of the strain readings ε_a takes place. When all elasticity measurements have been completed, the load is increase on the test specimen, at the specified rate, until failure of the specimen occurs. The scheme of the loading-unloading cycle during testing modulus of elasticity is presented in Fig. 3.16. Cylindrical specimen with three gauges mounted for measuring the changes in length is presented in Fig. 3.17. Gauge length was equal to of not less than two-thirds of the diameter of the test specimen. The gauges were attached in such a way that the gauge points were equidistant from the each other (180°) and at a distance not less than one quarter of the length of the test specimen from its ends. The achieved results of modulus of elasticity are presented in Fig. 3.18 and Tab 3.6.

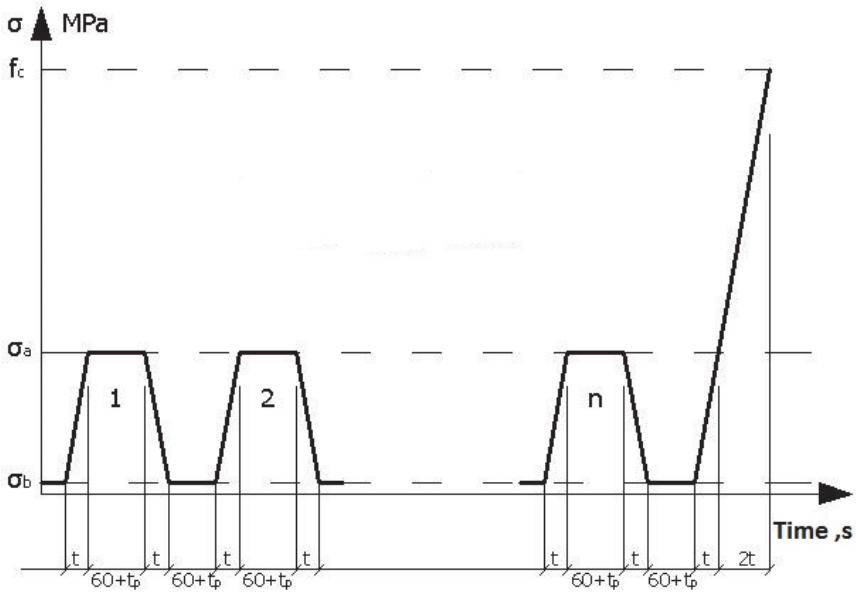

Fig. 3.16. The scheme of the loading-unloading cycle during testing modulus of elasticity (according to ISO 6784)

Rys. 3.16. Schemat cyklu obciążenie-odciążenie podczas badania modułu sprężystości (wg normy ISO 6784)

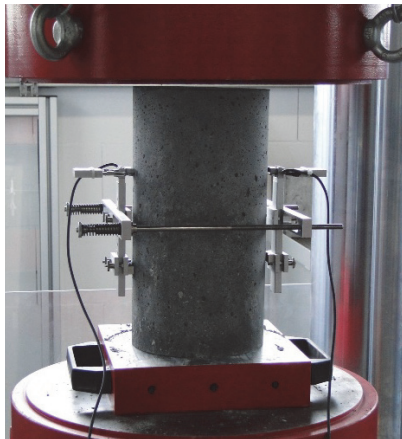

Fig. 3.17. Cylinder specimen prepared for testing procedure for establishing modulus of elasticity (photo by J. Domski)

Rys. 3.17. Próbkę walcową przygotowaną do procedury badawczej pozwalającej wyznaczyć moduł sprężystości (foto J. Domski)

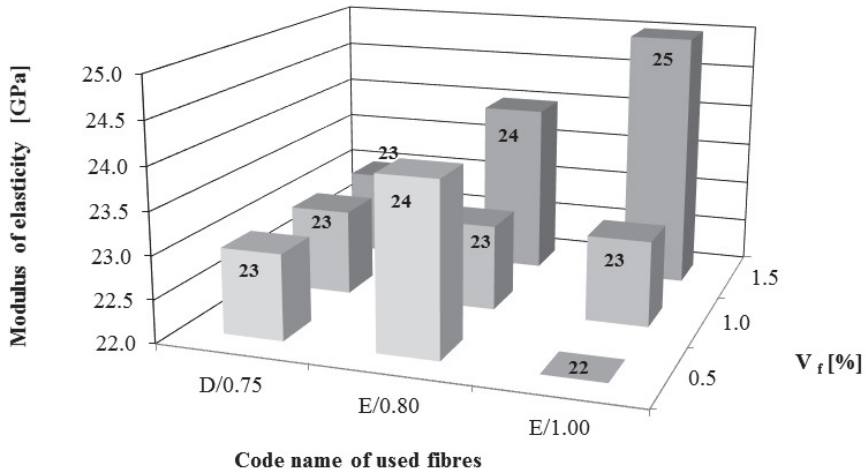

Fig. 3.18. Modulus of elasticity

Rys. 3.18. Moduł sprężystości

Table 3.6. Statistical description of results for modulus of elasticity

Tabela 3.6. Statystyczny opis wyników modułu sprężystości

Composite symbol	Modulus of elasticity [GPa]	Standard deviation [GPa]	Volatility ratio [%]
1	23	2.6	11.2
2	23	3.3	14.4
3	23	3.3	14.4
4	24	2.6	10.8
5	23	1.9	8.4
6	24	2.5	10.5
7	22	3.3	15.0
8	23	3.3	14.4
9	25	3.3	13.3
10	22	2.8	12.9

Values of modulus of elasticity for analysed composites are in range from 22 MPa to 25 MPa. Matrix is characterized by modulus of elasticity equal to 22 MPa. Composite no 9 has the highest E value of 25 MPa. It means that the maximum increase of E value is equal to 13.6%.

All composites modified by D/0.75 fibre are characterized by E equal to 23 MPa regardless of fibre addition. This value is only 4.54% higher than matrix characteristic. In general, it can be stated that no significant increase in modulus of elasticity was recorded during the research programme. The tested composites despite using non-conventional matrix behave similar to ordinary steel fibre reinforced concrete as far as modulus of elasticity is concerned.

The stress-strain testing procedure was also conducted on cylinder specimens. The original prototype apparatus (with three extensometers located every 120°) was harnessed to perform the test. The apparatus, which is shown in Fig.3.19 allowed to test specimens up to the very destruction of specimens. Using achieved data, the stress-strain relationships for cylinder specimens modified by 0.0, 0.5, 1.0 and 1,5% of fibre addition were plotted (Fig.3.20–3.22).

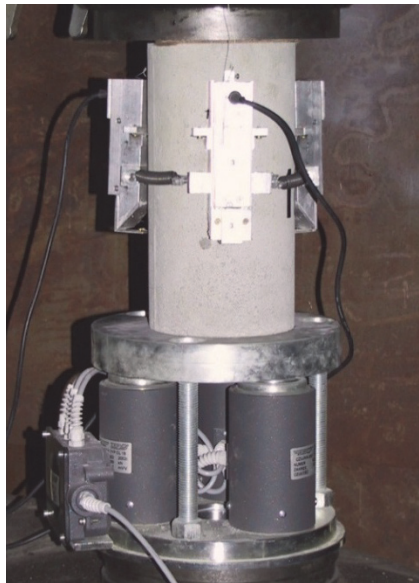

Fig. 3.19. Cylinder specimen prepared for testing procedure, for establishing stress-strain curves (photo by J. Dowski)

Rys. 3.19. Próbka walcowa przygotowana do procedury badawczej pozwalającej wyznaczyć zależność pomiędzy naprężeniem a odkształceniem (foto J. Dowski)

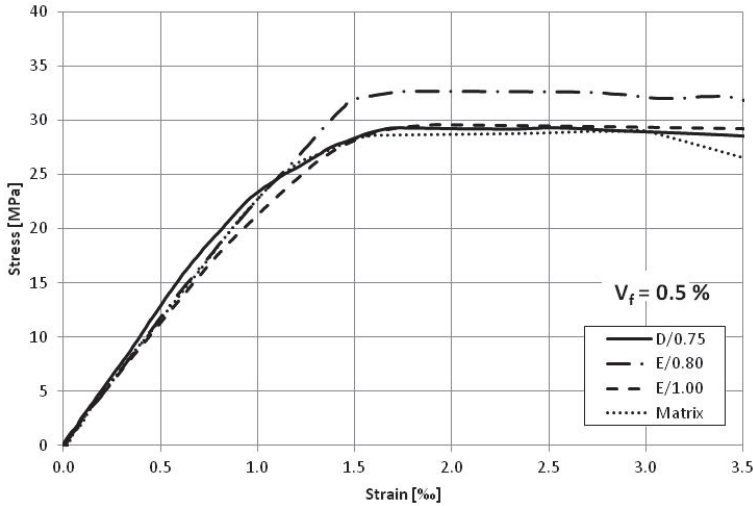

Fig. 3.20. Stress – strain relationships for cylinder specimens modified by 0.5% of fibre

Rys. 3.20. Zależności naprężenie – odkształcenie dla walców z dodatkiem 0,5% włókien

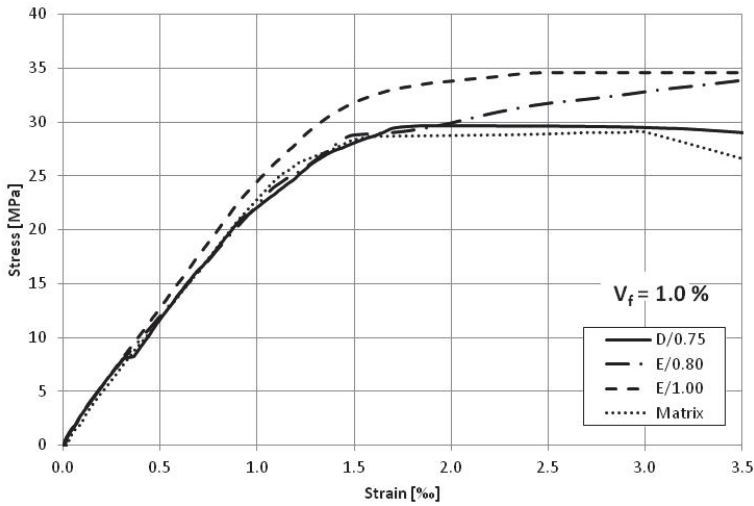

Fig. 3.21. Stress – strain relationships for cylinder specimens modified by 1.0% of fibre

Rys. 3.21. Zależności naprężenie – odkształcenie dla walców z dodatkiem 1,0% włókien

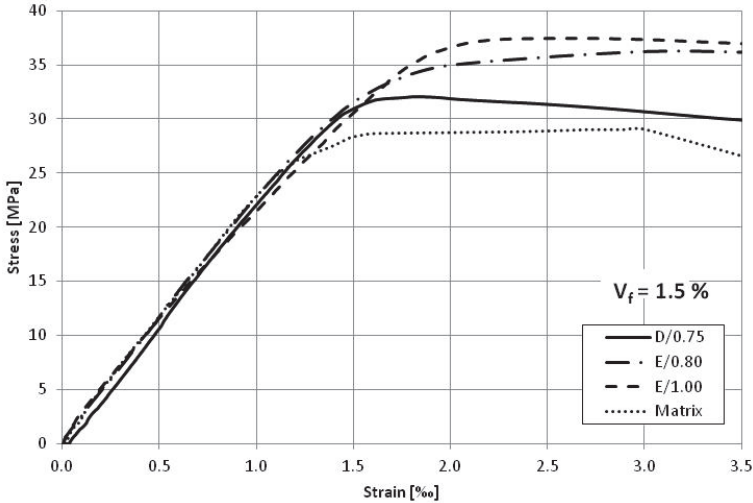

Fig. 3.22. Stress – strain relationships for cylinder specimens modified by 1.5% of fibre

Rys. 3.22. Zależności naprężenie - odkształcenie dla walców z dodatkiem 1,5% włókien

During the stress – strain testing procedure apart from extensometers, there were also used dynamometer. All sensors were connected to data acquisition system SAD-256. Increment of loading complied with EN 12390-3. Stress – strain relationships are very important for numerical analysis and modelling. Thus during the stress – strain testing procedure multiple parameters were followed and recorded, significantly exceeding code’s requirements. Authors wanted to get as much data as possible during this test, keeping in mind non-conventional character of the composite and associated with it lack of literature descriptions.

In Fig.3.20–3.22 one can follow stress – strain relations of tested fibre composites and the matrix. Shape of all presented stress – strain relations is similar and resembles σ – ε relation of ordinary concrete. One can divide stress – strain relations into two parts: “parabolic” and “square”. In case of matrix the parabolic part of the σ – ε relation ends after passing 1‰. Adding fibre to the matrix moves this point further. For maximum fibre addition ($V_f = 1.5\%$) the location of the end point of parabolic part of the σ – ε relation is located close to 2‰.

References

1. **de Brito J., Pereira A.S., Correia J.R.:** *Mechanical behaviour of non-structural concrete made with recycled ceramic aggregates*, Cement and Concrete Composites, 27(4), 2005: 429–433.
2. **Borovikov I. P., Borovikov V. P.:** *STATISTICA: Data Preparation and Analysis*. Moscow, Filini. 1998.
3. **Domski J., Katzer J.:** *Load-deflection Characteristic of Fibre Concrete Based on Waste Ceramic Aggregate*. Annual Set - The Environment Protection, Vol. 15, 69-80 (2013).
4. **Domski J., Katzer J., Fajto D.:** *Load-CMOD Characteristics of Fibre Reinforced Cementitious Composites Based on Waste Ceramic Aggregate*, Rocznik Ochrona Środowiska (Annual Set - The Environment Protection), Vol. 14, Year 2012, 69-80.
5. **EN 12390-3** *Testing hardened concrete – Part 3 Compressive strength of test specimen*.
6. **EN 12390-6** *Testing hardened concrete – Part 6 Tensile splitting strength of test specimens*.
7. **EN 12390-7** *Testing hardened concrete – Part 7 Density of hardened concrete*.
8. **EN 14651** *Test method for metallic fibered concrete – Measuring the flexural tensile strength (limit of proportionality (LOP), residual)*
9. **Graeff A.G., Pilakoutas K., Neocleous K., Peres M.V.N.:** *Fatigue Resistance and Cracking Mechanism of Concrete Pavements Reinforced with Recycled Steel Fibres Recovered from Post-Consumer Tyres*. Engineering Structures, Vol. 45, 385-395 (2012).
10. **ISO 6784** *Concrete – Determination of static modulus of elasticity in compression*.
11. **JCI-SF 6** *Method of Test for Shear Strength of Fibre Reinforced Concrete*.
12. **Johnston C.D.:** *Fibre reinforced cements and concretes*. Gordon and Breach Science Publishers, Amsterdam 2001.
13. **Maidl B.R.:** *Steel fibre reinforced concrete*. Ernst & Sohn. Berlin 1995.
14. **Mehta P.K., Monteiro P.J.M.:** *Concrete Microstructure, Properties and Materials*. Third edition, McGraw-Hill, New York, USA, 2006
15. **Neville A.M.:** *Properties of Concrete*. Longman, 4th Edition, Addison Wesley Longman, Harlow, Essex 1995.
16. **Pająk M., Ponikiewski T.:** *Flexural behavior of self-compacting concrete reinforced with different types of steel fibers*. Construction and Building Materials, Vol. 47, 397-408 (2013).

17. **Ponikiewski T., Golaszewski J.:** *Composition of steel fibre reinforced self-compacting concrete for optimal rheological and mechanical properties.* Conference: 7th International RILEM Conference on Self-Compacting Concrete. The 1st International RILEM Conference on Rheology and Processing of Construction Materials, 1-11, (2013).
18. **Ponikiewski T., Golaszewski J.:** *The Rheological and Mechanical Properties of High-performance Self-compacting Concrete with High-calcium Fly Ash.* Procedia Engineering, Vol. 65, 33-38 (2013).
19. **Seitl S., Bilek V., Kersner Z., Veselý J.:** *Cement based composites for thin building elements: Fracture and fatigue parameters.* Procedia Engineering, Vol. 2, 911-916 (2010).
20. **Tlemat H., Pilakoutas K., Neocleous K.:** *Stress-Strain Characteristics of SFRC Using Recycled Fibres.* Materials and Structures, Vol. 39, 333-345 (2006).
21. **Zych T., Krasodomski W.:** *Study on the properties of cement mortars with basalt fibres.* Conference: Brittle Matrix Composites 10, BMC 2010.

4. Material models for concrete under impulsive load

4.1. Introduction

The area of material damage models has undergone a rapid development in the past years. Skrzypek and Ganczarski [83], Skrzypek et al. [84] presented the state-of-art of the continuum damage mechanics approach to structural analysis. According to this formulation, the state of material damage is due to the presence of microdefects (cracks, voids, cavities). The damage of a material can be considered at various scales [45, 46, 91]: the atomic scale, the microscale and the macroscale. The assumption of the scale is a crucial decision for the structural analysis of the considered problem.

On the atomic scale, the material is assumed as discontinuous, and the state of its damage refers to the configuration of atoms. In this case, the current value of interatomic energy or the number of broken atomic constraints characterize the material damage

The microscale operates with size, orientation and number of microdefects occurred in material. Development and growth of microdefects in time is observed and considered as a measure of the current state of damage.

The macroscale uses the quasicontinuum formulation, where the discontinuous true damaged material is modeled by a fictitious undamaged continuum. Effective state variables, consisting of effective stress and strain tensors, scalars defining isotropic hardening, tensors referred to kinematic hardening, describe this continuum, instead of classical variables for true damaged material. In order to determine the whole set of effective state variables associated with this fictitious undamaged material, the equivalence of the selected state variables for the true damaged and fictitious undamaged material has to be applied [80]. Lemaitre [50], Lemaitre and Chaboche [51] applied the strain equivalence; the stress equivalence has been used by Simo and Ju [80, 82].

Cordebois and Sidoroff [16, 17], Sidoroff [79] applied the assumption of elastic energy equivalence. The damage parameter and damage law based on strain energy development was investigated by Chrzanowski [13, 14]. Total energy equivalence was assumed by Chow and Lu [12]. Damage theories based on energy equivalence were discussed in papers of Yu [40, 41]

One of the fundamental concepts in continuum damage mechanics is the "representative volume element", introduced in order to model the discontinuous true damaged material with a fictitious quasicontinuous undamaged one, with defined set of effective state variables. In this element the true distribution of microdefects is smeared out and homogenized on the macroscale by a set of adequately defined damage variables. These variables being scalars, vectors and tensors function as internal variables characterizing the current damage state of the true material.

Scalar damage variables have been proposed by Kachanov [42, 43], Rabotnov [75-77], Hayhurst [35], Hayhurst and Leckie [36], Chrzanowski [13], Hayhurst et al. [37], Dunne et al. [21-25]. Vector variables were used by Davison and Stevens [18], Kachanov [43,44]; second rank tensor by Rabotnov [77], Vakulenko and Kachanov [89], Murakami and Ohno [63], Litewka [53-57], Murakami [64-66], Murakami et al. [67-70], Hayakawa et al. [34]; fourth rank tensor by Chaboche [9], Leckie and Onate [48], Simo and Ju [80], Krajcinovic [46], Chen and Chow [11], Voyiadjis and Park [90]. Discussion of tensorial damage representation can be found in papers by Betten [5]. Isotropic damage defined by two independent scalar parameters was considered and the physical limitations on the path to full damage have been developed by Cauvin and Testa [7].

4.2. Plasticity based models

The most commonly used theories for the modeling of concrete are plasticity, fracture-based approaches and continuum damage mechanics (CDM). Plasticity, which has been successfully applied to metals, is nowadays theoretically consolidated and world-widely recognized as computationally efficient. Examples of its application to concrete can be found in Ohtani and Chen [71], Etse and Willam [26] and Feenstra and de Borst [28], as well as in Chen [10] reviews and references therein. Though the plasticity models are far superior to elastic approaches in representing hardening and softening characteristics, they fail to address the process of damage due to microcracks growth, such as the stiffness degradation, the unilateral effect, etc. Intermingled with classical continuum mechanics in uncoupled manner, fracture mechanics suggests an approach to describe localized damage as to be represented by the ideal

or regular discrete cracks with definite geometries and locations, and it has been extensively used in engineering practice [45].

However, the associated questions whether the J integrals and stress intensity factors are material parameters or not are far from being settled [93]. Besides, before the appearance of macrocracks in concrete there exist a lot of smeared microcracks whose geometries and locations could not be determined precisely, so it appears difficult to apply fracture mechanics for modeling concrete.

Based on the thermodynamics of irreversible processes, the internal state variable theory and relevant physical considerations [40], CDM provides a powerful and general framework for the derivation of consistent constitutive models suitable for many engineering materials, including concrete. In the earlier literature [58, 59], CDM was restricted to linear “elastic damage” mechanics for brittle materials, i.e., linear elastic solids with distributed microcracks, affording different ways for handling observed phenomena like the stiffness degradation, the tensile softening and the unilateral effect due to the development of microcracks and microvoids. More examples of elastic CDM models for concrete can be found in Lubarda et al. [57], Cervera et al. [8], Halm and Dragon [31], Comi and Perego [15], etc.

Coupled with plasticity or by means of empirical definitions, the irreversible strains due to plastic flow can also be accounted for in elastoplastic damage theories, such as those proposed by Ortiz [72], Lemaitre [52], Dragon [20], Resende [78], Simo and Ju [80], Yazdani and Schreyer [93], Carol et al. [6], di Prisco and Mazars [19], Lee and Fenves [49], Faria et al. [27], Hatzigeorgiou [33], Hansen et al. [32], Taqieddin et al. [87] among others.

4.3. Criteria of damage for material models

One of the critical issues associated with damage model of concrete is selection of damage criteria. Several different criteria, such as the equivalent strain-based [58], and the stress-based approaches [12; 72] as well as the damage energy release rate-based (DERR-based) proposals [40, 58; 80], are generally adopted in the current practice. Among them, it has been pointed out that [40] the equivalent strain-based damage criteria are only appropriate for the elastic state, and the stress-based damage criteria are inherently inadequate for predicting the perfect plastic dam-

age growth. As is well known, in classical plasticity the stress tensor is thermodynamically conjugated to the plastic strain tensor, so the yield criteria are defined as functions of the stress tensor invariants. Analogously thermodynamically consistent damage criteria might be based on DERRs that are the conjugated forces to the damage variables.

However, most of the above referred damage models, except given by Ju [40], are based on the Helmholtz free energy (HFE) and the DERR proposed by Lemaitre [52], where contribution of the plastic strains to the microcrack growth process is not considered, and the driving force of damage growth is the elastic DERR alone, which might not be physically appropriate. Therefore, if the damage criteria are based on the elastic DERRs, the strength enhancement observed in the compression–compression domain [47] cannot be predicted (see the unilateral damage model of Mazars [58]). To deal with the above problem, Ju [40] suggested an elastoplastic one-scalar damage model in which both the plastic strains and the plastic HFE were defined based on the effective stress space plasticity to cope with the coupled effects between the damage evolutions and the plastic flow. However, only in very simple situations such as Von Mises plasticity with linear isotropic hardening, the plastic HFE was provided explicitly in the model, and for other plasticity models more appropriate for concrete, it could only be computed incrementally with numerical integration, which might be time-consuming and unsteady. Moreover, though the model is thermodynamically more reasonable, but only under uniaxial compression its predicted results might agree with experimental observations; and no examples for concrete under more complex stress states, e.g., biaxial compression, were provided yet.

To improve the fitting of the model predictions to the concrete experimental data, other researchers [27; 15] abandoned the DERR-based damage criteria, and turned to the empirically defined ones. In spite of the satisfactory results obtained under pure tension and pure compression stress states, in the tension–compression domain the model of Faria et al. [27] neglects the influence on the compressive strength in one direction due to the tensile stress or strain acting perpendicularly and vice versa, which is obviously conflicting with the experimentally observed strength decays [47, 88]. In [15] a pure elastic-damage model is proposed, where the damage criteria were described by a hyperbola for the tensile stress domains and an ellipse for the pure compressive stress quadrants.

To identify the basic mechanisms that lead to concrete damage growth, some primary features of concrete behaviour experimentally observed in tests are presented first. When loaded in compression concrete experiences progressive loss of stiffness in the deviatoric space along with observed volumetric changes when approaching collapse putting into evidence strong dilatancy.

The available experimental results in tension indicate a deviatoric behaviour similar to that observed in compression, but the volumetric performance, unlike in compression, is of a softening nature. Finally, under hydrostatic compression concrete exhibits somewhat softening behaviour at low stress levels, but as stress increases a predominantly stiffening behaviour is observed; upon unloading, concrete behaves almost elastically at first, losing stiffness progressively afterwards [78].

Consequently, three damage mechanisms can be consensually identified from the experimental observations, which are: (i) a tensile one, which represents the separation of material particles leading to cracks developed predominantly in fracture mode I; (ii) a shear one, inherent to mode II, associated to the breaking of internal bonds during the loading of concrete in shear; and finally (iii) a compressive consolidation one, due to collapse of the microporous structure of cement matrix under triaxial compression.

From these damage mechanisms it is possible to conclude that:

- Loaded in tension concrete damage is activated as the result of both the tensile and shear mechanisms in the deviatoric space. In general the former one develops much quicker than the latter one [78], and thus the shear damage mechanism can be ignored for convenience. In the volumetric space the damage of concrete is activated by the tensile damage mechanism.
- Loaded in compression concrete damage is activated by the shear damage mechanism. The compressive consolidation mechanism of concrete in the volumetric space will be partially taken into consideration via minor modification of the shear damage criteria.

Thus, two basic but distinct mechanisms, namely the tensile and compressive damage ones, respectively, are consistently referred to in the derivation of the constitutive model to be presented herein.

The effectiveness and performance of a damage model depends heavily on its particular choice of a set of damage variables, which actually serves as a macroscopic approximation for describing the underlying micromechanical process of microcracking. In current literature, there are many ways to define appropriate damage variables which are phenomenologically defined or micromechanically derived. In this paper the attention is limited to the phenomenological approach. According to the damage variables adopted, the CDM models can be classified essentially in two categories: (i) the scalar damage ones, where one or several scalars are adopted to characterize the isotropic damage processes [58, 27, 49]; (ii) the tensor damage ones, where second-order, fourth-order or even eighth-order damage tensor are necessary to account for anisotropic damage effects [72, 20, 93].

The one-scalar damage models [58, 80, 40] are somewhat limited to describe the unilateral effect inherent to concrete behaviour. Moreover, Poisson's ratio is inferred to be a constant in this kind of damage model, which is inconsistent with the phenomena that Poisson's ratio decrease under tensile load and increase under compressive load due to microcracking. In fact, even for isotropic damage, not a one-scalar damage variable but at least a fourth-order damage tensor should be employed to characterize the state of damage in materials [41]. However, the inherent complexities of numerical algorithms required by most of the anisotropic tensor damage models restrict their applicability to practical engineering.

Lubarda and Krajcinovic [57] published a paper, where some fundamental issues in the rate theory of damage-elastoplasticity were elaborated on. The material degradation and induced elastic anisotropy were introduced by a set of damage tensors.

Tensile and a shear damage variable were adopted by Wu et. al. [92] to describe the degradation of the macromechanical properties of concrete. The evolution law for the plastic strains and the explicit expression for the elastoplastic Helmholtz free energy were determined and the damage energy release rates that are conjugated to the damage variables were derived.

Tao and Philips [86] elaborated a simplified isotropic damage model for concrete under bi-axial stress states. The model incorporates the failure of concrete into a conventional continuum damage mechanics framework, where particular emphasises are placed on highlighting the

different responses of concrete under tension and compression, as well as the different contributions of hydrostatic and deviatoric stress components on concrete damage.

A constitutive model for predicting dynamic anisotropic damage and fragmentation of rock materials under blast loading, using a second rank symmetric damage tensor was studied and described by Zhang et. al. [94].

Material damage, characterized by the degradation of elastic modulus, have been considered by Jones et al. [38] and Alves et al. [3].

The development and characteristic features of damage in concrete under load of various kind have been studied by many researchers in the framework of continuum damage mechanics. Meyer and Peng [61] investigated the damage of concrete subjected to complex loading, modelling and analysis of reinforced concrete structures for dynamic loading of various nature was the subject of the selection of papers edited by Meyer [62]. Cyclic loading of concrete and the damage mechanics model were analysed by Paskova and Meyer [73]. Damage of concrete with fiber reinforcement [29, 30] was compared with behaviour of plain concrete in order to assess the adequacy of constitutive material model. More general material model for plain concrete, based on thermomechanics was put forward in the work of Peng et al. [74].

There is also a wide variety of survey concerning scientific and practical aspects of continuum damage mechanics. Allix and Hild [1] published the proceedings of the lectures aimed to present engineers and scientists with an overview of the latest developments in the field of damage mechanics. The formulation of damage models and their identification procedures were discussed for a variety of materials.

Although the exhaustive presentation by McDowell [60] of state-of-the-art for the application of continuum damage mechanics in fracture and fatigue analysis concerns in majority the composites, metals and ceramic materials, the general remarks about the effect on nonuniformity of distribution on the evolution of damage were also presented. Impact loading and its consequences to the development of material damage has been described there.

Altenbach and Skrzypek [2] introduced the textbook with a concise survey of constitutive and structural modeling for high temperature creep, damage, low-cycle fatigue and other inelastic conditions. The book shows the creep and continuum damage mechanics as rapidly de-

veloping discipline which interlinks the material science foundations, the constitutive modeling and computer simulation application to analysis and design of engineering structures.

The book of Skrzypek and Ganczarski [85] contains invited lectures from the international symposium on the anisotropic behavior of damaged materials. Eminent researchers and world experts in the field of damage mechanics report recent achievements and state-of-the-art results in the field. The book deals with the anisotropic damage mechanics involving micromechanical aspects and thermo-mechanical coupling.

A wide survey of progress in nonlocal integral formulations of plasticity and damage can be find in publication of Bažant and Jirásek [4]. This paper reviews the last achievements in the nonlocal material models of integral type, and discusses their physical justifications, advantages, and numerical applications.

References

1. **Allix O., Hild F., (Eds.):** *Continuum Damage Mechanics of Materials and Structures*, Elsevier New York, 2002.
2. **Altenbach H., Skrzypek J.J.:** *Creep and Damage in Materials and Structures*, CISM International Centre for Mechanical Sciences. Courses and Lectures, NR 399, Springer Verlag, Wien, 1998.
3. **Alves M., Yu J., Jones N.:** *On the elastic modulus degradation in continuum damage mechanics*. Computers and Structures, Vol. 76, 703-712, 2000.
4. **Bažant Z.P., Jirásek M.:** *Nonlocal Integral Formulations of Plasticity and Damage: Survey of Progress*. J. Eng. Mech., 1119-1149, 2002.
5. **Betten J.:** *Application of tensor functions in Continuum Damage Mechanics*. Int. J. Damage Mech., Vol.1, 47-59, 1992.
6. **Carol I., Rizzi E., Willam K.:** *A unified theory of elastic degradation and damage based on a loading surface*. International Journal of Solids and Structures, Vol. 31, 2853-2865, 1994.
7. **Cauvin A., Testa R.B.:** *Elastoplastic material with isotropic damage*. International Journal of Solids and Structures, Vol. 36, 727-746, 1999.
8. **Cervera M., Oliver J., Faria R.:** *Seismic evaluation of concrete dams via continuum damage models*. Earthquake Engineering and Structural Dynamics, Vol. 24, 1225-1245, 1995.

9. **Chaboche J.L.:** *Le concept de contrainte effective appliqué à l'élasticité et à la viscoplasticité en présence d'un endommagement anisotrope*. In: *Mechanical Behaviour of Anisotropic Solids*, Boehler J.P. (ed.), Editions CNRS, Paris, 737-760, 1982.
10. **Chen W.F.:** *Constitutive Equations for Engineering Materials—Plasticity and Modeling*. vol. 2. Elsevier, Amsterdam, 1994.
11. **Chen X.F., Chow C.L.:** *On damage strain energy release rate*. *Int. J. Damage Mech.*, Vol. 4, 251-263, 1995.
12. **Chow C.L., Lu T.J.:** *An analytical and experimental study of mixed-mode ductile fracture under nonproportional loading*. *Int. J. Damage Mech.*, Vol. 1, 191-236, 1992.
13. **Chrzanowski M.:** *Damage Parameter in Continuum Damage Mechanics*. *Mech. Teor. Stos.*, Vol. 16, 151-167, 1978 (in Polish).
14. **Chrzanowski M.:** *Strain Energy Governed Damage Law For a Visco-Plastic Material*. *Eng. Trans.*, Vol. 39, 389-418, 1991.
15. **Comi C., Perego U.:** *Fracture energy based bi-dissipative damage model for concrete*. *International Journal of Solids and Structures*, Vol. 38, 6427–6454, 2001.
16. **Cordebois J.P., Sidoroff F.:** *Endommagement anisotrope en élasticité et plasticité*. *J. Méc. Théor. Appl.*, Numero Spécial, 45-60, 1982 (in French).
17. **Cordebois J.P., Sidoroff F.:** *Damage induced elastic anisotropy*. In: *Mechanical Behavior of Anisotropic Solids*. Boehler J.P. (ed.), Martinus Nijhoff, Boston, 761-774, 1983.
18. **Davison L., Stevens A.L.:** *Thermodynamical constitution of spalling elastic bodies*. *J. Appl. Phys.*, Vol. 44, 668-674, 1993.
19. **di Prisco M., Mazars J.:** *Crush-crack: a non-local model for concrete*. *Mechanics of Cohesive-Frictional Materials*, Vol. 1, 321–347, 1996.
20. **Dragon A.:** *Plasticity and ductile fracture damage: study of void growth in metals*. *Engineering Fracture Mechanics*, Vol. 21, 875–885, 1985.
21. **Dunne F.P.E., Othman A.M., Hall F.R., Hayhurst D.R.:** *Representation of uniaxial creep curves using continuum damage mechanics*. *Int. J. Mech. Sci.*, Vol. 32, 945-957, 1990.
22. **Dunne F.P.E., Hayhurst D.R.:** *Continuum damage based constitutive equation for copper under high temperature creep and cyclic plasticity*. *Proc. R. Soc. Lond.*, A 437, 545-566, 1992.
23. **Dunne F.P.E., Hayhurst D.R.:** *Modelling of combined high-temperature creep and cyclic plasticity in components using Continuum Damage Mechanics*. *Proc. R. Soc. Lond.*, A 437, 567-589, 1992.

24. **Dunne F.P.E., Hayhurst D.R.:** *Efficient cycle jumping techniques for the modelling of materials and structures under cyclic mechanical and thermal loadings.* Eur. J. Mech. A/Solids, Vol. 13, 639-660, 1994.
25. **Dunne F.P.E., Hayhurst D.R.:** *Physically based temperature dependence of elastic-viscoplastic constitutive equations for copper between 20 and 500°C.* Phil. Mag., A 74, 359-382, 1995.
26. **Etse G., Willam K.:** *Fracture energy formulation for inelastic behaviour of plain concrete.* Journal of Engineering Mechanics, ASCE 120, 1983–2011, 1994.
27. **Faria R., Oliver J., Cervera M.:** *A strain-based plastic viscous-damage model for massive concrete structures.* International Journal of Solids Structures, Vol. 14, 1533–1558, 1998.
28. **Feenstra P.H., de Borst R.:** *A composite plasticity model for concrete.* International Journal of Solids and Structures, Vol. 33, 707–730, 1996.
29. **Grzybowski M., Meyer C.:** *Damage Prediction for Concrete with and without Fiber Reinforcement.* Dept. of Civil Engineering and Engineering Mechanics, Columbia University, New York, 1992.
30. **Grzybowski M., Meyer C.:** *Damage Accumulation in Concrete with and Without Fiber Reinforcement.* ACI Materials Journal, Vol 11-12, 1993.
31. **Halm D., Dragon A.:** *A model of anisotropic damage mesocrack growth: unilateral effect.* International Journal of Damage Mechanics, Vol. 5, 384–402, 1996.
32. **Hansen E., Willam K., Carol I.:** *A two-surface anisotropic damage/plasticity model for plain concrete.* In: *Proceeding of Framcos-4 Conference*, Paris, 2001.
33. **Hatzigeorgioiu G.:** *A simple concrete damage model for dynamic FEM applications.* International Journal of Computational Engineering Science, Vol. 2, 267–286, 2001.
34. **Hayakawa K., Murakami S.:** *Space of damage conjugate force and damage potential of elastic-plastic-damage materials.* in: *Damage Mechanics in Engineering Materials*, Voyiadjis G.Z., Ju J.W., Chaboche J.L., (eds.), Elsevier, Amsterdam, 27-44, 1998.
35. **Hayhurst D.R.:** *Creep rupture under multiaxial state of stress.* J. Mech. Phys. Solids, Vol. 20, 381-390, 1972.
36. **Hayhurst D.R., Leckie F.A.:** *The effect of creep constitutive and damage relationship upon rupture time of solid circular torsion bar.* J. Mech. Phys. Solids, Vol. 21, 431-446, 1973.

37. **Hayhurst D.R., Dimmer P.R., Morrison C.J.:** *Development of continuum damage in the creep rupture of notched bars.* Phil. Trans. R. Soc. Lond., A 311, 103-129, 1984.
38. **Jones N., Alves M., Yu J.L.:** *On the Elastic Modulus Degradation in Continuum Damage Mechanics.* Comp. & Struct., Vol. 76, 703-712, 2000.
39. **Ju J.W.:** *On energy-based coupled elastoplastic damage theories: Constitutive modeling and computational aspects.* Int. J. Solids & Struct., Vol. 25, 803-833, 1989.
40. **Ju J.W.:** *On energy-based coupled elastoplastic damage models at finite strains.* J. of Eng. Mech., ASCE, Vol. 115, 2507-2525, 1989.
41. **Ju J.W.:** *Isotropic and anisotropic damage variables in continuum damage mechanics.* J. of Eng. Mech., ASCE, Vol. 116, 2764-2770, 1990.
42. **Kachanov L.M.:** *Time of the rupture process under creep conditions.* Izv. AN SSSR, Otd. Tekh., Nauk., Vol. 8, 26-31, 1958.
43. **Kachanov L.M.:** *Foundations of Fracture Mechanics.* Moscow, Nauka, 1974
44. **Kachanov L.M.:** *Introduction to Continuum Damage Mechanics.* Netherlands, Martinus Nijhoff, 1986
45. **Krajcinovic D.:** *Contiuum Damage Mechanics; When and How?* Int. J. Damage Mech., Vol. 4, 217-229, 1995.
46. **Krajcinovic D.:** *Damage Mechanics.* Elsevier, Amsterdam, 1996.
47. **Kupfer H., Hilsdorf H.K., Rusch H.:** *Behaviour of concrete under biaxial stress.* Proc. ACI, Vol. 66, 656-666, 1969.
48. **Leckie F.A., Onat E.T.:** *Tensorial nature of damage measuring internal variables, in: Physical Non-Linearities in Structural Analysis.* Hult J., Lemaitre J., (eds.), Springer-Verlag, 1981.
49. **Lee J., Fenves G.L.:** *Plastic-damage model for cyclic loading of concrete structures.* Journal of Engineering Mechanics Division, Vol. 124, 892-900, 1998.
50. **Lemaitre J.:** *Evaluation of dissipation and damage in metals submitted to dynamic loading.* Proceedings of I.C.M., Kyoto, Japan, Vol. 1, 1971
51. **Lemaitre J., Chaboche J.L.:** *Aspect phenomenologique de la rupture par endommagement.* J. Mec. Appl., Vol. 2, 317-365, 1978.
52. **Lemaitre J.:** *A continuum damage mechanics model for ductile fracture.* Journal of Engineering Materials Technology, Vol. 107, 83-89, 1985.
53. **Litewka A.:** *Effective material constants for orthotropically damaged elastic solid.* Arch. Mech., Vol. 37, 631-642, 1985.
54. **Litewka A.:** *On stiffness and strength reduction of solids due to crack development.* Eng. Fract. Mech., Vol. 25, 637-643, 1986.

55. **Litewka A.:** *Analytical and experimental study of fracture of damaging solids.* In: *Yielding, Damage and Failure of Anisotropic Solids.* Boehler J.P. (ed.), Mech. Eng. Publ., London, 655-665, 1987.
56. **Litewka A.:** *Creep rupture of metals under multi-axial state of stress.* Arch. Mech. Vol. 41, 3-23, 1989.
57. **Lubarda V.A., Krajcinovic D., Mastilovic S.:** *Damage model for brittle elastic solids with unequal tensile and compressive strength.* Engineering Fracture Mechanics, Vol. 49, 681–697, 1994.
58. **Mazars J.:** *A model of unilateral elastic damageable material and its application to concrete.* In: *Proceedings of the RILEM International Conference on Fracture Mechanics of Concrete,* Lausanne, Switzerland, Elsevier, New York, 1985.
59. **Mazars J., Pijaudier-Cabot G.:** *Continuum damage theory: application to concrete.* Journal of Engineering Mechanics, Vol. 115, 345–365, 1989.
60. **McDowell D.L.:** *Applications of Continuum Damage Mechanics to Fatigue and Fracture.* American Society for Testing & Materials; 1997.
61. **Meyer C., Peng X.:** *A Comprehensive Description for Damage of Concrete Subjected to Complex Loading.* Structural Engineering and Mechanics, Vol 5, 679-689, 1997.
62. **Meyer C. (ed.):** *Modeling and Analysis of Reinforced Concrete Structures for Dynamic Loading.* CISM Courses and Lectures No. 346, Springer, Wien-NewYork, 1998.
63. **Murakami S., Ohno N.:** *A continuum theory of creep and creep damage.* In: *Creep in Structures.* Ponter A.R.S., Hayhurst D.R. (eds.), Springer-Verlag, 422-444, 1981.
64. **Murakami S.:** *Notion of continuum damage mechanics and its application to anisotropic creep damage theory.* J. Eng. Mater. Technol., Vol. 105, 99-105, 1983.
65. **Murakami S.:** *Progress in continuum damage mechanics.* Int. J. JSME., Vol. 30, 701-710, 1987.
66. **Murakami S.:** *Mechanical modelling of material damage.* J. Appl. Mech., Vol. 55, 280-286, 1988.
67. **Murakami S., Mizuno M., Okamoto T.:** *Mechanical modelling of creep swelling and damage under irradiation of polycrystalline metals.* Nucl. Engng., Design, Vol. 131, 147-155, 1991.
68. **Murakami S., Mizuno M.:** *A constitutive equation of creep, swelling and damage under neutron irradiation applicable to multiaxial and variable states of stress.* Int. J. Solids Structures, Vol. 29, 2319-2328, 1992.

69. **Murakami S., Kamiya K.:** *Constitutive and damage evolution equations of elastic-brittle materials based on irreversible thermodynamics.* Int. J. Solids Structures, Vol. 39, 473-486, 1997.
70. **Murakami S., Hayakawa K., Liu Y.:** *Damage evolution and damage surface of elastic-plastic-damage materials under multiaxial loading.* Int. J. Damage Mech., Vol. 7, 103-128, 1998.
71. **Ohtani Y., Chen W.F.:** *Multiple hardening plasticity for concrete materials.* Journal of Engineering Mechanics, ASCE 114, 1890–1910, 1988.
72. **Ortiz M.:** *A constitutive theory for inelastic behaviour of concrete.* Mechanics of Materials, Vol. 4, 67–93, 1985.
73. **Paskova T., Meyer C.:** *Damage Mechanics Based Model for Cyclic Response of Concrete,* In: *Fracture and Damage in Quasibrittle Structures.* Bazant Z.P. et al. (eds.), E & FN Spon, London, 1994.
74. **Peng X., Meyer C. Fang L.:** *Thermomechanically Consistent Continuum Damage Model for Concrete Materials.* Engineering Mechanics Journal, ASCE, 1997.
75. **Rabotnov Y.N.:** *Damage from creep.* Zhurn. Prokl., Mekh. Tekhn. Phys., Vol. 2, 113-123, 1963.
76. **Rabotnov Y.N.:** *Creep rupture.* Proc. of 12 Int. Congr. Appl. Mech., 342-349, 1968.
77. **Rabotnov Y.N.:** *Creep Problems in Structural Members.* Nort-Holland, Amsterdam, 1969.
78. **Resende L.:** *A damage mechanics constitutive theory for the inelastic behaviour of concrete.* Computer Methods in Applied Mechanics and Engineering, Vol. 60, 57–93, 1987.
79. **Sidoroff. F.:** *Description of anisotropic damage application to elasticity.* In: *Physical Non-Linearities in Structural Analysis.* Hult J., Lemaitre J. (eds.), Springer, Berlin, 237-244, 1981.
80. **Simo J.C., Ju J.W.:** *Strain- and stress-based continuum damage models; I – Formulation, II – Computational aspects.* Int. J. Solids Structures, Vol. 23, 821-869, 1987.
81. **Simo J.C., Ju J.W., Pister K.S., Taylor R.L.:** *On strain-based continuum damage models: Formulation and computational aspects.* Proceedings of the Second International Conference and Short Course on Constitutive Laws for Engineering Materials: Theory and Application, Univ. of Arizona, USA, 233-246, 1987.
82. **Simo J.C., Ju J.W.:** *On continuum damage-elastoplasticity at finite strains: A computational framework.* Computational Mechanics, Vol. 5, 375-400, 1989.

83. **Skrzypek J., Ganczarski A.:** *Application of the orthotropic damage growth rule to variable principal directions.* Int. J. Damage Mech., Vol. 7, 180-206, 1998.
84. **Skrzypek J., Kuna-Ciskal H., Ganczarski A.:** *Continuum damage mechanics modelling of creep-damage and elastic-damage-fracture in materials and structures.* In *Modeling of Damage and Fracture Processes in Engineering Materials, Trends in Mechanics of Materials*, IPPT, Warsaw, 1999.
85. **Skrzypek J., Ganczarski A.:** *Modeling of Material Damage and Failure of Structures.* Springer Verlag, Berlin-Heidelberg, 1999.
86. **Tao X., Philips D.V.:** *A simplified isotropic damage model for concrete under bi-axial stress states.* Cement & Concrete Composites, Vol. 27, 716–726, 2005.
87. **Taqieddin Z.N., Voyiadjis G.Z., Almasri A.H.:** *Formulation and Verification of a Concrete Model with Strong Coupling between Isotropic Damage and Elastoplasticity and Comparison to a Weak Coupling Model.* Journal of Engineering Mechanics Vol. 138(5), 530-541, 2012.
88. **Vecchio F.J., Collins M.P.:** *The modified compression-field theory for reinforced concrete elements subjected to shear.* ACI Structure Journal, Vol 2, 219–231, 1986.
89. **Vakulenko A.A., Kachanov M.:** *Continuum theory of medium with cracks.* Izv. AN SSSR, M.T.T., Vol. 4, 159-166, 1971.
90. **Voyiadjis G.Z., Park T.:** *Anisotropic damage for the characterization of the onset of macro-crack initiation in metals.* Int. J. Damage Mech., Vol. 5, 68-92, 1996.
91. **Woo C.W., Li D.L.:** *A universal physically consistent definition of material damage.* Int. J. Solids Structures, Vol. 20, 2097-2108, 1993.
92. **Wu J.Y., Li J., Faria R.:** *An energy release rate-based plastic-damage model for concrete.* International Journal of Solids and Structures, Vol. 43, 583–612, 2006.
93. **Yazdani, S., Schreyer, H.L.:** *Combined plasticity and damage mechanics model for plain concrete.* Journal of Engineering Mechanics, Vol. 116 , 1435–1450, 1990.
94. **Zhang Y., Hao H, Lu Y.:** *Anisotropic dynamic damage and fragmentation of rock materials under explosive loading.* International Journal of Engineering Science, Vol. 41, 917–929, 2003.

5. Impact resistance of circular plates – experimental and numerical study

The main part of scientific research project *Impact resistant concrete elements with nonconventional reinforcement* (National Science Centre grant 2011/01/B/ST8/06579) were the experimental and numerical tests carried on circular plates realized with concrete produced from rubble waste and steel fibres [4, 7, 9]. Experimental part of the research was accomplished in the laboratory, and numerical analyses have been performed as a simulation of observed real dynamic response of the structure.

5.1. Experimental tests

The former analyses and studies on concrete samples realized with addition of waste materials (ceramic bricks rubble) and steel fibres allowed for research carried on larger elements, similar to structural elements in practical use. In this case the elements were circular plates (diameter 1.0 m, 0.10 m thickness) with various percentage of steel fibres reinforcement.

The set of 70 plates in 10 types has been produced. Each type is characterized by quantity and kind of used products. The adequate small size samples (cubes, cylinders, beams, etc.) were also fabricated for the standard tests of material characteristics of concrete (Fig. 5.1).

In order to carry on the experimental tests the adequate stand has been built (Fig. 5.2) from steel modular elements of high load carrying capacity. Tested plates were installed on the three massive supports located on the circumference. The view of the plate prepared for the test is shown in Fig. 5.3, and a schematic localization of the plate, supports and load in Fig. 5.4. During the test, the plate has been load by the free fall of 40 kg mass from the 1.0 m height.



Fig. 5.1. The entire set of samples and plates prepared for experimental tests
Rys. 5.1. Widok partii próbek i płyt do badań doświadczalnych

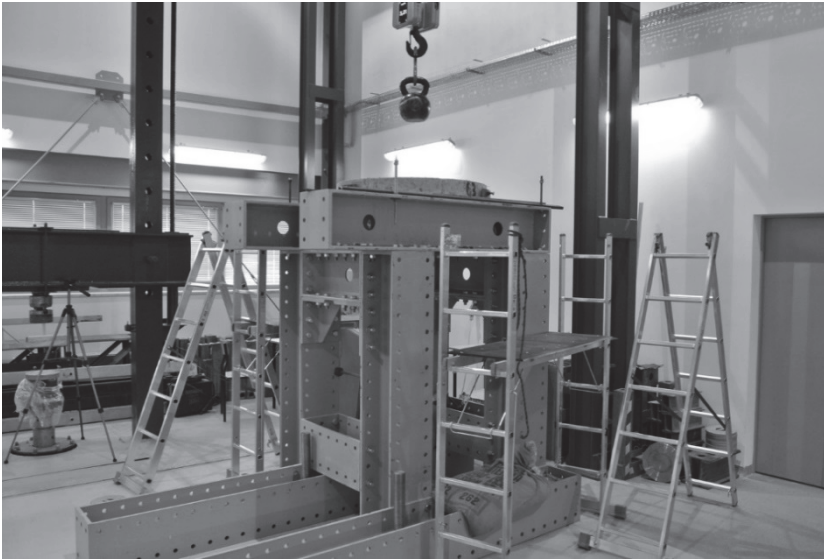

Fig. 5.2. The stand for experimental tests of plates
Rys. 5.2. Stanowisko do badań dynamicznych płyt

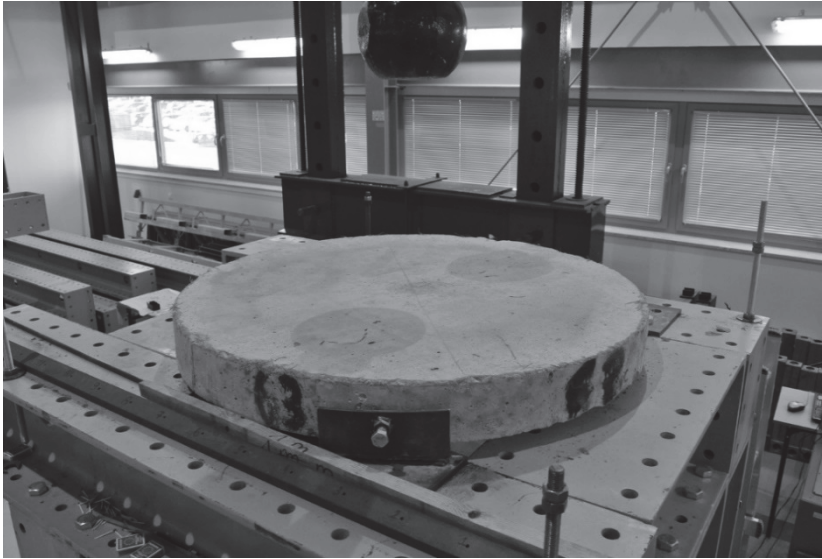

Fig. 5.3. The plate before tests

Rys. 5.3. Jedna z płyt przed badaniem

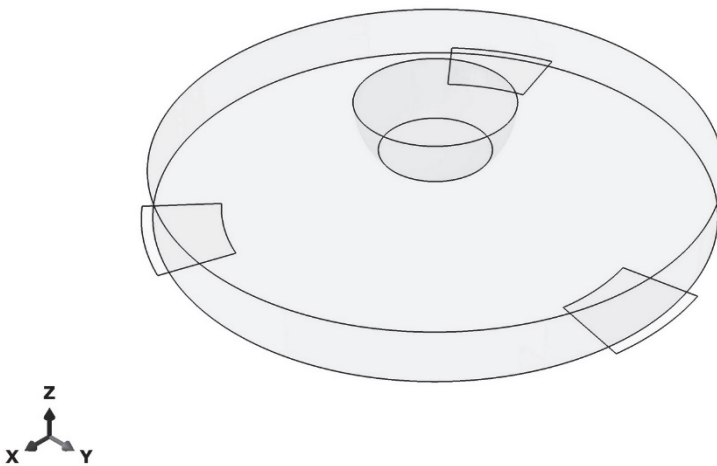

Fig. 5.4. The scheme of testing configuration (plate, supports, load)

Rys. 5.4. Schemat stanowiska badawczego (płyta, podpory, obciążnik)

Table 5.1. Types of tested circular plates**Tabela 5.1.** Rodzaje badanych płyt kołowych

Type of plates	Fibres	Reinforcement	Average number of impacts
M0	No fibres	0,0%	1
E1-05	E/0.8 50 x 0.8 mm	0,5%	7
E1-10	E/0.8 50 x 0.8 mm	1,0%	14
E1-15	E/0.8 50 x 0.8 mm	1,5%	21
E2-05	E/1.00 50 x 1.0 mm	0,5%	8
E2-10	E/1.00 50 x 1.0 mm	1,0%	11
E2-15	E/1.00 50 x 1.0 mm	1,5%	19
D1-05	D/0.75 60 x 0.75 mm	0,5%	6
D1-10	D/0.75 60 x 0.75 mm	1,0%	23
D1-15	D/0.75 60 x 0.75 mm	1,5%	70

The plate subjected to tests were subjected to several impacts, after each impact the displacements were measured as well as the development of fractures. Basic features of individual plates and the average number of impacts leading to the total damage of the plate are presented in Table 5.1. The applied recipes for the concrete and assumed reinforcement resulted in different damage patterns, examples shown in Figures 5.5–5.8. Distribution of damages for the plate without any reinforcement is presented in Figure 5.5 – this plate has been damaged after first impact. Plates shown in subsequent figures (Fig. 5.6–5.8) need a bigger number of impacts, the photos demonstrate different pattern of cracks development, their distribution and reduced opening.

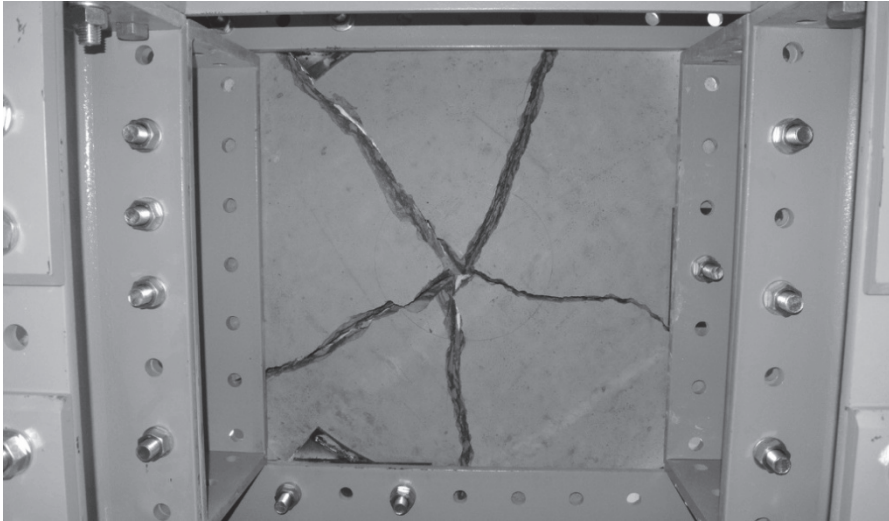

Fig. 5.5. Plate without reinforcement (M0) after first impact, bottom view
Rys. 5.5. Płyta bez zbrojenia (M0) po pierwszym uderzeniu, widok z dołu



Fig. 5.6. Reinforced plate (E2-05) after several impacts, bottom view
Rys. 5.6. Płyta zbrojona (E2-05) po serii uderzeń, widok z dołu

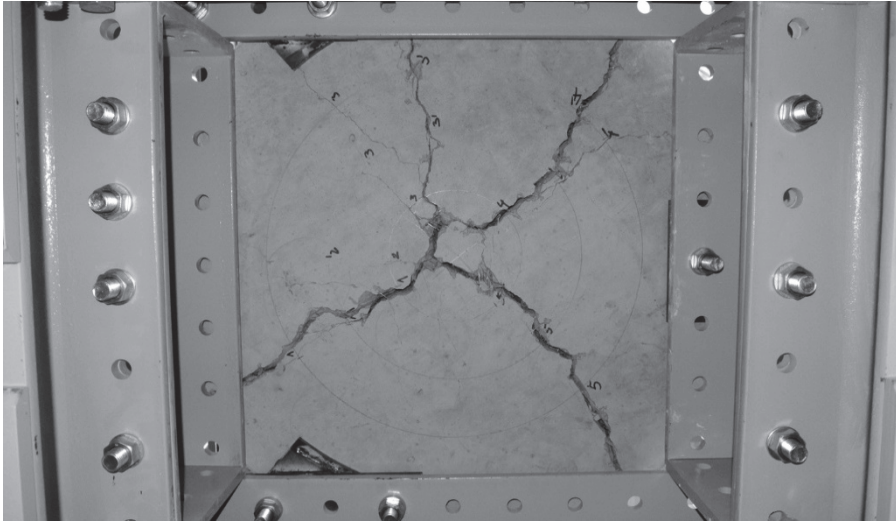

Fig. 5.7. Reinforced plate (E2-10) after several impacts, bottom view
Rys. 5.7. Płyta zbrojona (E2-10) po serii uderzeń, widok z dołu

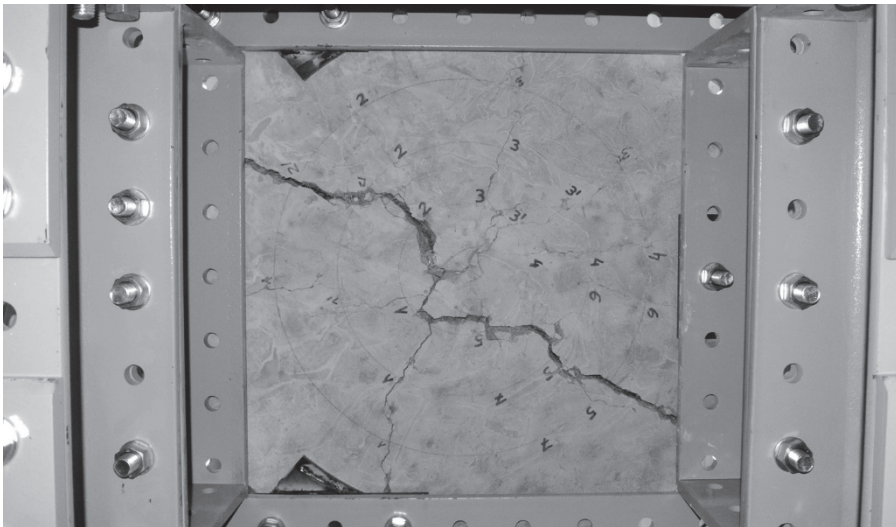

Fig. 5.8. Reinforced plate (E2-15) after several impacts, bottom view
Rys. 5.8. Płyta zbrojona (E2-15) po serii uderzeń, widok z dołu

5.2. Numerical analysis

The numerical simulation of dynamic response for tested plates has been carried out as a necessary supplement, in order to validate the assumed discrete finite element model. Analyses have been performed for selected four types of plates (Tab. 5.2) from the entire set of ten types.

General assumptions for physical model were common for all considered cases (Fig. 5.9) and concerned the dimensions of plates, localization of supports and applied impact load. The plates varied in material characteristics, and assumed presence of fibres.

Table 5.2. Basic characteristics of concrete for selected types of plates

Tabela 5.2. Podstawowe cechy zastosowanego betonu, w wybranych grupach płyt

Type of plates	Modulus of elasticity [GPa]	Compressive strength [MPa]	Tensile strength [MPa]
M0	22	39.14	3.12
E2-05	22	44.10	3.38
E2-10	23	50.54	4.02
E2-15	25	51.89	4.56

Table 5.3. Basic characteristics of applied fibres

Tabela 5.3. Podstawowe cechy zastosowanych włókien

Symbol	Modulus of elasticity [GPa]	Yield stress [MPa]	Tensile strength [MPa]
E/1.00	210	890	935

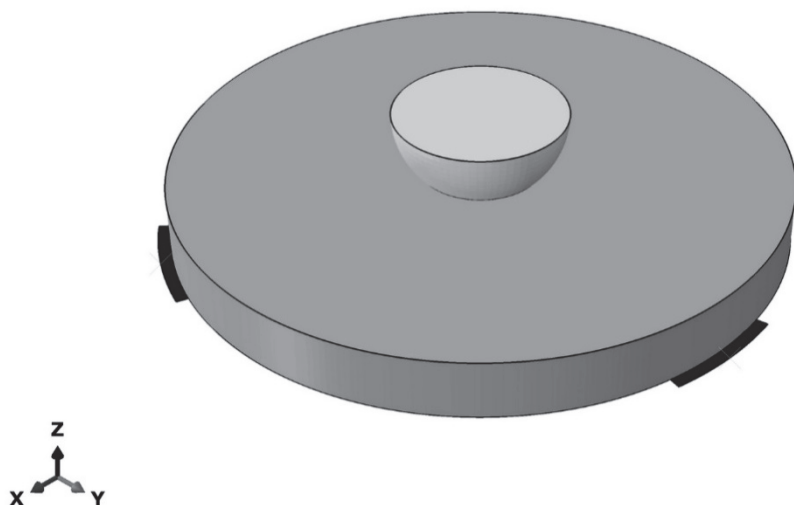

Fig. 5.9. Plate on the test site – numerical model

Rys. 5.9. Model płyty na stanowisku badawczym

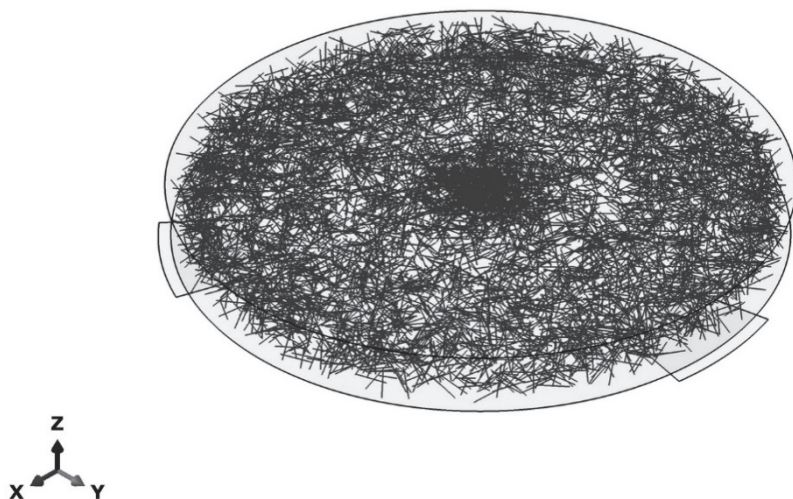

Fig. 5.10. An example of dispersed reinforcement in a model of the plate

Rys. 5.10. Przykładowy widok zbrojenia rozproszonego w modelu płyty

Initial analyses with assumption of homogenized material model (i.e. concrete and steel fibres modelled as homogenized continuum) did not give the results consistent with experimental observations [4]. Due to this fact the model assumed for final numerical simulations and analyses consists with two different elements: concrete (three dimensional continuum) and steel fibres with random distribution inside the entire volume of concrete. Concrete and steel have been modelled according their real parameters (Tab. 5.3). An example of randomly distributed fibre reinforcement is shown in Fig. 5.10, for the plate E2-10.

Numerical simulation has been carried using Finite Element Method (FEM) computer code ABAQUS [10]. Both the applied method and software are well known and efficient tools for static and dynamic analysis of structures [6, 12, 18, 19].

Due to complexity of assumed physical model the creation of computational model for each of considered plates was realized using the user's procedure written in *Python programming language* [11], an environment integrated with ABAQUS code with the scope to build the numerical models, carry out the computations and analyse the results.

Numerical model is based on real dimensions of concrete plate, steel fibres, supports and impactor. The plate was modelled as three-dimensional deformable solid body. Supports was assumed as non-deformable surfaces. The contact between the plate and supports was assumed as *master-slave* type. Impactor was modelled as deformable cast-iron solid body, the contact between the plate and impactor was also realized as *master-slave* type algorithm. For plate M0 the presence of fibres has been omitted. For plates E2-05, E2-10 and E2-15 the exact amount of fibres used to produce the plates has been considered. The localization of each fibre in numerical models was defined using the *pseudo-random number generator*. Coordinates of the middle of the fibre and the angles defining orientation towards assumed coordinate system were randomly selected. Additionally, the characteristics of space distribution of fibres in similar elements were taken into account (for example – the distribution through the thickness of the plate) [14, 15].

The crucial factor for entire numerical model is the assumed constitutive material model, especially for materials with nonlinear behaviour and damage [2, 3, 20].

Material model *Concrete Damaged Plasticity* (CDP) [10] was assumed to describe the material behaviour of plain concrete. This model is characterized by elasto-plastic behaviour in compression and brittle cracking response in tension. For both cases the model takes into account an independent development of damages and stress reduction during the cracking process [2]. Model assumes nonassociated potential plastic flow and used for this model is the Drucker-Prager hyperbolic function. CDP is an efficient tool for static [12] and dynamic analysis [6, 17, 18] of reinforced concrete structures. Characteristics for this model have been assumed as for the plate M0 (plate without reinforcement – Tab. 5.2).

Material model for fibres was assumed as elasto-plastic model for ductile steel, with Huber-Mises-Hencky yield criterion and isotropic plastic hardening [20]. Basic characteristics of this model are given in Tab. 5.2. For impactor the material parameters for cast iron were assumed according [20].

Finite element mesh was built by discretization of the plate, fibres, impactor and supports. Plate was discretized using three-dimensional 8-node linear solid elements, fibres - three-dimensional 2-node linear displacement truss elements, impactor - three-dimensional 8-node linear solid elements, and supports - three-dimensional quadrilateral rigid elements.

Due to impulsive characteristics of entire phenomenon, the explicit integration scheme was used to analyse the dynamic response of the plate [1, 8, 10].

Selected results of calculations are presented in Fig. 5.11–5.15. Results concerning distribution of damages in a plate without reinforcement are shown in Fig. 5.11, adequate results for reinforced plates (E2-05, E2-10, E2-15) are shown in Fig. 5.12–5.14. Additionally, in Fig. 5.15 the example of plastic equivalent strains distribution for plate E2-10 is presented.

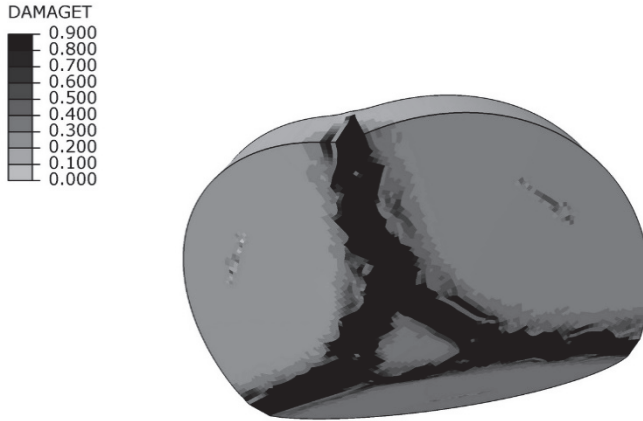

Fig. 5.11. Distribution of damages. Plate without reinforcement (M0), after first impact, bottom view

Rys. 5.11. Rozkład uszkodzeń w płycie bez zbrojenia (M0), po pierwszym uderzeniu, widok z dołu

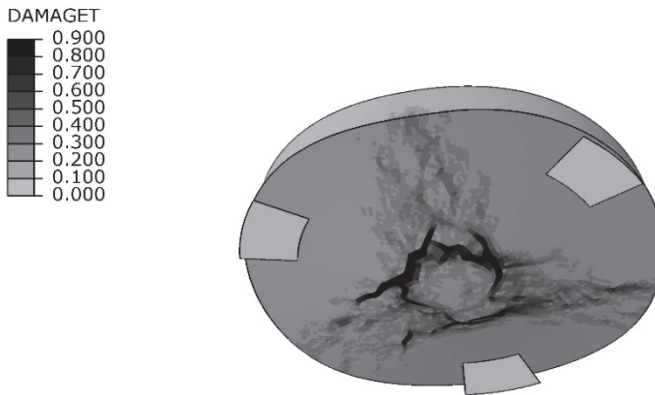

Fig. 5.12. Distribution of damages. Plate with reinforcement (E2-05), after three impacts, bottom view

Rys. 5.12. Rozkład uszkodzeń w płycie zbrojonej (E2-05), po serii trzech uderzeń, widok z dołu

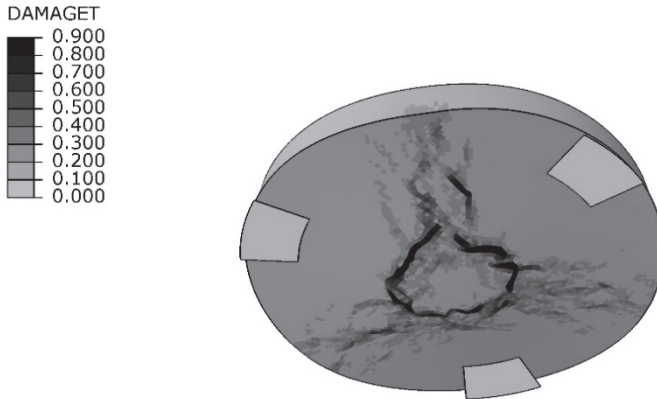

Fig. 5.13. Distribution of damages. Plate with reinforcement (E2-10), after three impacts, bottom view.

Rys. 5.13. Rozkład uszkodzeń w płycie zbrojonej (E2-10), po serii trzech uderzeń, widok z dołu

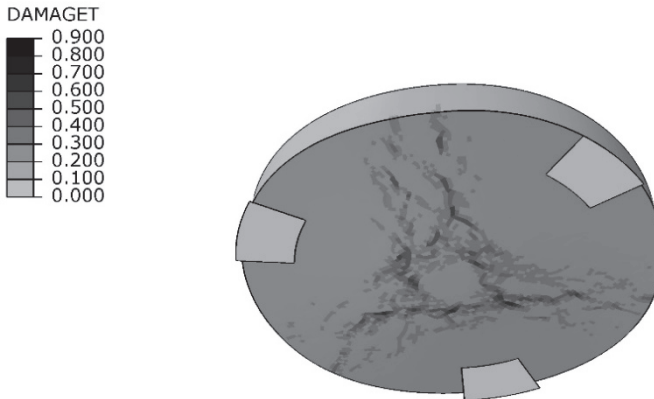

Fig. 5.14. Distribution of damages. Plate with reinforcement (E2-15), after three impacts, bottom view.

Rys. 5.14. Rozkład uszkodzeń w płycie zbrojonej (E2-15), po serii trzech uderzeń, widok z dołu

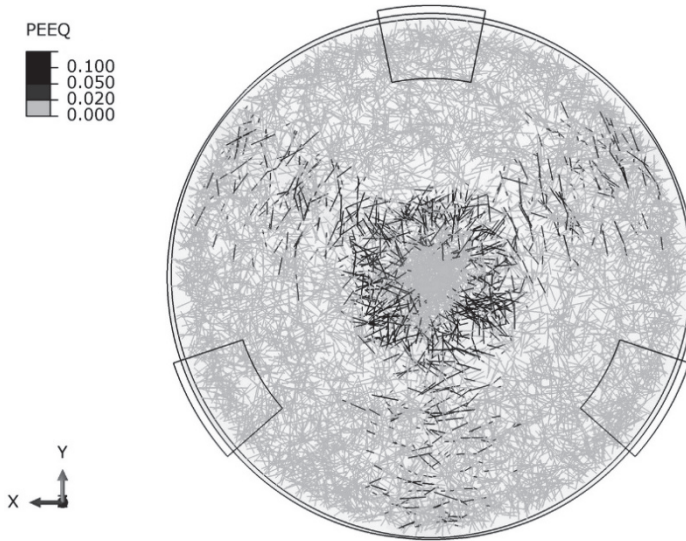

Fig. 5.15. Distribution of equivalent plastic strains in fibres. Plate with reinforcement (E2-10), after three impacts, upper view

Rys. 5.15. Rozkład zastępczych odkształceń plastycznych w rozproszonym zbrojeniu płyty (E2-10), po serii trzech uderzeń, widok z góry

5.3. Final remarks

The performed impact tests on circular plates are an important supplement in research on material characteristics of concrete produced from waste materials. Applied methodology of laboratory experimental tests [4] provided many interesting results, not available with the use of other methods [13]. Tests carried out on standard samples and impact tests on structural elements allowed for correct identification of material characteristics, difficult to realize in another way [16, 21].

Experimental study carried out on circular plates demonstrated the dependence between the dynamic response of structure and the material characteristics of concrete and fibres.

Elaborated numerical models taking into account the random distribution of fibres in plate volume allowed gave the results consistent with real distribution of damages in tested plates.

References

1. **Belytschko T., Liu W.K., Moran B.:** *Nonlinear Finite Elements for Continua and Structures*. John Wiley & Sons, 2000.
2. **Cichocki K.:** *Numerical Analysis of Concrete Structures under Blast Load*. Koszalin University of Technology, 2008.
3. **Cichocki K., Adamczyk R., Ruchwa, M.:** *Material modelling for structures subjected to impulsive loading*. Computer Assisted Mechanics and Engineering Sciences, Vol. 6(2), 231-244 (1999).
4. **Cichocki K., Domski J., Katzer J., Ruchwa, M.:** *The use of waste aggregate in building industry*. In: *Nordic Symposium for Energy Efficiency in Buildings*. Oulu, Finland, 27 September 2013. [Online]. Available from: http://www.oamk.fi/hankkeet/ieeb/final_symposium/materials/cichocki-1.pdf (2013).
5. **Cichocki K., Ruchwa M.:** *Badania eksperymentalne i analiza numeryczna niekonwencjonalnie zbrojonych elementów betonowych*. In: *XIII Konferencja Naukowo-Techniczna TECHNIKI KOMPUTEROWE W INŻYNIERII 2014, TKI-2014. STRESZCZENIA*. Licheń Stary, Poland, 6-9 May 2014. Warsaw: Military University of Technology. 39-40. (2014).
6. **Cichocki K., Ruchwa M.:** *Integrity analysis for multistorey buildings*. Ovidius University Annals - Constantza. Series: Civil Engineering. Constantza, Romania: Ovidius University Press, Vol. 15, 45-52 (2013).
7. **Cichocki K., Ruchwa M.:** *Numerical analysis of fibre reinforced slabs under impact loads*. In: *20th International Conference on Computer Methods in Mechanics, CMM-2013. Short Papers*. Poznań, Poland, 27-31 August 2013. Poznań: Poznań University of Technology. 379-380. (2013).
8. **Cook R.D., Malkus D.S., Plesha M.E.:** *Concepts and applications of finite element analysis. Third edition*. John Wiley & Sons, 1989.
9. **Domski J., Katzer J.:** *Load-deflection Characteristic of Fibre Concrete Based on Waste Ceramic Aggregate*. Annual Set - The Environment Protection, Vol. 15, 69-80 (2013).
10. Dassault Systemes SIMULIA: *ABAQUS Analysis User's Manual*. Providence, 2013.
11. Dassault Systemes SIMULIA: *ABAQUS Scripting Reference Guide*. Providence, 2013.
12. **Głodkowska W., Ruchwa M.:** *Static analysis of reinforced concrete beams strengthened with CFRP composites*. Archives of Civil Engineering, Vol. LVI(2), 111-122 (2010).
13. **Katzer J., Kobaka J.:** *Combined Non-Destructive Testing Approach to Waste Fine Aggregate Cement Composites*. Science and Engineering of Composite Materials, Vol. 16(4), 277-284 (2009).

14. **Pająk M., Ponikiewski T.:** *Flexural behavior of self-compacting concrete reinforced with different types of steel fibers*. Construction and Building Materials, Vol. 47, 397-408 (2013).
15. **Ponikiewski T., Katzer J., Bugdol M., Rudzki M.:** *Steel fibre spacing in self-compacting concrete precast walls by X-ray computed tomography*. Materials and Structures, Vol. 10, 1-12 (2014).
16. **Rucevskis S., Wesolowski M.:** *Identification of damage in a beam structure by using mode shape curvature squares*. Shock and Vibration, Vol. 17(4-5), 601-610 (2010).
17. **Ruchwa M.:** *Ocena odporności konstrukcji żelbetowej na działanie wybuchu*. Biuletyn Wojskowej Akademii Technicznej, Vol. LIX(4), 269-280 (2010).
18. **Ruchwa M.:** *Wykorzystanie spienionych metali do ochrony konstrukcji przed obciążeniami udarowymi*. Materiały Budowlane, Vol. 11, 38-40 (2013).
19. **Smadi M.M., Belakhdar K.A.:** *Nonlinear Finite Element Analysis of High Strength Concrete Slabs*. Computers and Concrete, An International Journal, Vol. 4(3), 187-206 (2007).
20. **Souza Neto E.A. de, Perić D., Owen D.R.J.:** *Computational methods for plasticity. Theory and applications*. John Wiley & Sons 2008.
21. **Wesolowski M., Barkanov E.:** *Model errors influence on identified composite material properties*. Composite Structures, Vol. 94, 2716-2723 (2012).

6. Conclusions and final remarks

The research carried out within the framework of project “*Impact resistant concrete elements with nonconventional reinforcement*” (National Science Centre grant 2011/01/B/ST8/06579) allowed for better understanding the entire problem and to gain the experience necessary to design, produce and analyze structures or their elements. Two major problems were analyzed experimentally and numerically:

- Application of waste materials to produce concrete. In this study the ceramic brick rubble was used as a substitute of traditional mineral gravel.
- Addition of steel fibers in order to produce structural elements resistant to impact loads. Although this solution is well known and popular in many practical applications there was a lack of experimental results concerning the extent of damages produced by such kind of loads in structural elements.

In authors’ opinion the problem of waste materials application in engineering practice is a growing tendency, observed in many developed countries. The increased demand for primary raw materials necessary to produce basic structural elements for civil engineering industry is limited by natural (lack of natural sources of mineral gravel) and environmental (protection of environment and landscape) reasons.

At present the use of waste materials as a substitute of gravel is still difficult and not always economical. Growing cost of transportation, difficulties to continue exploitation of natural sources of gravel and development of methods necessary to modify and recycle the raw waste materials into material ready to use lead to conclusions confirming the necessity to carry out such kind of scientific research.

This study contains many observations concerning the characteristics of concrete produced using the waste material – in this case limited to sorted and prepared ceramic brick rubble. Of course further investigation is still necessary in order to apply other kinds of wastes, mainly concrete available commonly in large quantities

Addition of steel fibers to concrete in order to obtain the almost homogeneous material (comparing with traditional reinforcement) resistant to many kinds of impact loads was the main goal of experimental

and numerical study performed on the set of circular plates. Special attention was paid to observe the entire process of initiation, development of damages and their pattern for various types of fires and percentage of dispersed reinforcement volume for the same kind of load (impact produced by a free fall of weight from the constant height 1 m).

Experimental results were the base for advanced numerical simulation performed with Finite Element Method computer code ABAQUS. Although the major part of features necessary to carry out such kind of study is well known and have been applied by authors in other numerical simulations, in this study the attempt to consider the random distribution of fibers in concrete volume has been done. The adequate algorithm to generate the distribution of steel fibers inside the defined volume, together with necessary boundary conditions (fibers cannot overlap or cross the boundary surfaces, etc.) has been written, implemented and successfully tested and verified. After generation of random distribution of steel fibers, they were embedded into three dimensional discrete numerical model of concrete structure. In this way the finite element model is very close to the real structure, without fictitious assumptions and simplifications. Of course, this need a powerful hardware, and the entire process is still a time-consuming one. The expected optimization of preprocessing algorithm will simplify the entire process.

Numerical analysis allows to simulate the entire phenomenon, define the robustness of the structure (understood as the structural ability to carry the loads after the development of damages) and its resistance level for any kind of exceptional loads (mainly impulsive due to impacts and blasts). The results obtained by numerical simulations of experimental tests are consistent (i.e. patterns, extent and development of damages are very similar) and enable to test other configurations (i.e. loads, geometry of plates, material characteristics, percentage of reinforcement, etc).

Elementy betonowe odporne na uderzenia z niekonwencjonalnym zbrojeniem

Streszczenie

Przedmiotem monografii jest analiza doświadczalna oraz numeryczna próbek oraz elementów wykonanych z kompozytu fibrobetonowego z udziałem kruszywa odpadowego (sortowany gruz ceglany). Badania doświadczalne oraz symulacje numeryczne przeprowadzone zostały w ramach grantu Narodowego Centrum Nauki pt. "Impact resistant concrete elements with nonconventional reinforcement" (2011/01/B/ST8/06579) i dotyczyły one badania własności wytrzymałościowych materiału oraz powstawiania oraz rozwoju zniszczeń w płytach z fibrobetonu obciążonych udarowo.

Monografia składa się z sześciu rozdziałów, uzupełnionych o odpowiednią bibliografię.

Rozdział pierwszy (Introduction) dotyczy sformułowania problemu będącego przedmiotem pracy. Uzasadniono w nim potrzebę wprowadzenia do wytwarzania elementów betonowych materiałów odpadowych, zastępujących tradycyjne kruszywo mineralne, motywując to zmniejszaniem się zasobów tych kruszyw, zwiększaniem kosztów transportu oraz względami związanymi z ochroną środowiska i krajobrazu. Wprowadzenie zbrojenia rozproszonego w postaci włókien stalowych umożliwia zdaniem autorów monografii uzyskanie materiału odpornego na obciążenia nagłe (uderzenia, wybuchy), zdolnego do przenoszenia naprężeń rozciągających powstających podczas propagacji fali w materiale.

Rozdział drugi (Used materials and research programme) poświęcony jest opisowi zastosowanych w badaniach materiałów oraz założonemu programowi badań dotyczących wyznaczania podstawowych parametrów charakteryzujących materiały.

W rozdziale trzecim (Mechanical properties) podano opis i rezultaty wykonanych badań podstawowych charakterystyk materiałowych fibrobetonu z udziałem kruszywa odpadowego.

Rozdział czwarty (Material models for concrete under impulsive load) zawiera przegląd konstytutywnych modeli materiałowych stosowanych w analizie numerycznej ustrojów betonowych poddanych obciążeniom o charakterze nagłym (impulsowym). Skupiono się na modelach zawierających kryteria powstawiania i rozwoju zniszczeń w materiale, oraz kryterium całkowitego zniszczenia (tj. utraty możliwości przenoszenia obciążeń).

Rozdział piąty (Impact resistance of circular plates – experimental and numerical study) stanowi opis zasadniczej części badań objętych projektem, tj. testom eksperymentalnym i symulacjom numerycznym odpowiedzi dynamicznej kołowych płyt o średnicy 1,0 m i grubości 0,10 m, wykonanych z fibrobetonu z udziałem kruszywa odpadowego i obciążonych swobodnym spadkiem ciężaru 40 kg z wysokości 1,0 m. Wykonano w sumie 70 płyt w 10 wariantach różniących się rodzajem włókien oraz stopniem zbrojenia. Zbadano zależność intensywności rozwoju zniszczeń w poszczególnych płytach od ilości uderzeń, starając się doprowadzić badania do momentu całkowitej utraty nośności płyty.

Na podstawie przeprowadzonych badań eksperymentalnych wykonano symulacje numeryczne przy zastosowaniu metody elementów skończonych, wykorzystując opracowany algorytm generacji losowego rozkładu włókien wobjętości elementu betonowego. Analizy wykonano w środowisku systemu elementów skończonych ABAQUS/Explicit, stosując nieliniowy sprężysto-plastyczny model materiałowy ze zniszczeniem dla opisu własności betonu. Wyniki symulacji numerycznych są zgodne z rezultatami uzyskanymi na drodze eksperymentalnej.

Rozdział szósty (Conclusions and final remarks) zawiera krótkie podsumowanie uzyskanych rezultatów oraz uwagi dotyczące samego analizowanego zagadnienia.

Monografia uzupełniona jest o krótkie notki biograficzne autorów.



Krzysztof Cichocki – associate professor of Koszalin University of Technology (Poland), Department of Structural Mechanics, Faculty of Civil Engineering, Environmental and Geodetic Sciences.

His scientific activity concerns numerical simulation of complex engineering problems, including impact dynamics (explosions, crashes, etc), constitutive material modelling, analysis of vehicle trajectories

due to accidents and many other real-life scenarios and phenomena. He was working on many research projects, in Italy (Dipartimento di Ingegneria Strutturale, Politecnico di Milano), USA (FAMU-FSU College of Engineering, Tallahassee) and Poland (Koszalin University of Technology). He was a coordinator of many research projects, granted by Committee of Scientific Research, Ministry of Science and Higher Education, National Centre of Science.

His didactic activity also concerns various subjects connected with numerical methods in mechanics, structural dynamics, computational methods, analysis of limit states for structures, etc.

List of chosen publications by Krzysztof Cichocki

Cichocki K., Ruchwa M. (2013) *Integrity analysis for multistorey buildings*. Ovidius University Annals - Constantza. Series: Civil Engineering. Constantza, Romania: Ovidius University Press, (15), pp. 45-52.

Cichocki K., Ruchwa M. (2013) *Numerical analysis of fibre reinforced slabs under impact loads*. In: *20th International Conference on Computer Methods in Mechanics, CMM-2013. Short Papers*. Poznań, Poland, 27-31 August 2013. Poznań: Poznań University of Technology. pp. 379-380.

Cichocki K., Ruchwa M. (2013) *Numerical analysis of fibre reinforced slabs under impact loads*. In: *20th International Conference on Computer Methods in Mechanics, CMM-2013. Short Papers*. Poznań, Poland, 27-31 August 2013. Poznań: Poznań University of Technology. pp. 379-380.

- Cichocki K., Domski J., Katzer J., Ruchwa M.** (2013) *The use of waste aggregate in building industry*. In: *Nordic Symposium for Energy Efficiency in Buildings*. Oulu, Finland, 27 September 2013. [Online]. Available from: http://www.oamk.fi/hankkeet/ieeb/final_symposium/materials/cichocki-1.pdf
- Cichocki K., Domski J., Katzer J.** (2013) *Markets for prefabricated timber houses in Poland*. In: *Nordic Symposium for Energy Efficiency in Buildings*. Oulu, Finland, 27 September 2013. [Online]. Available from: http://www.oamk.fi/hankkeet/ieeb/final_symposium/materials/cichocki2.pdf
- Cichocki K., Kulesza U.** (2013) *Numeryczna analiza propagacji pęknięć w elementach betonowych*. *Materiały Budowlane*, (11), pp. 9-11.
- Cichocki K., Ruchwa M.** (2011) *Propagation of damages in structures under blast load*. *Zeszyty Naukowe Politechniki Rzeszowskiej. Budownictwo i Inżynieria Środowiska*, 58(3/11/III), pp.17-24.
- Cichocki K.** (2008) *Robustness Oriented Analysis of Concrete Structures Subjected to Blast Exposure*. In: *Proc. of the 1st Workshop. Action COST-TU0601*. Zurich, Switzerland, pp. 123-132.
- Cichocki K.** (2008) *Material Modelling for Concrete Plate Subjected to Blast Load*. In: *Proc. of 8th. World Congress on Computational Mechanics (WCCM8), 5th. European Congress on Computational Methods in Applied Sciences and Engineering (ECCOMAS 2008)*. Venice, Italy.
- Cichocki K.** (2008) *Numerical Analysis of Concrete Structures under Blast Load*. Wydawnictwo Uczelniane Politechniki Koszalińskiej.
- Cichocki K., Ruchwa M.** (2001) *Numerical analysis of concrete slabs subjected to blast loading*. In: *European Conference on Computational Mechanics, ECCM-2001*. Cracow, Poland, 26-29 June 2001, pp.572-573.
- Cichocki K., Ruchwa M.** (2000) *Steel stiffened plates subjected to a blast load*. *JOURNAL DE PHYSIQUE IV*, (10), pp. 535-540.
- Cichocki K., Adamczyk R., Ruchwa M.** (1999) *Material modelling for structures subjected to impulsive loading*. *Computer Assisted Mechanics and Engineering Sciences*, 6(2), pp. 231-244.
- Adamczyk R., Cichocki K., Ruchwa M.** (1998) *Effect of protective coating on underwater structure subjected to an explosion*, *Computational Modelling of Concrete Structures, Euro-C IV, Badgastein, Austria, April*, pp. 623-631



Jacek Domski – assistant professor of Kozsalin University of Technology

He is a successful Ph.D. M.Sc. B.Sc. qualified scientist, highly experienced engineer of concrete structures. He has wide experience as a concrete researcher, mix designer, quality controller of concrete production (both ready-mix and precast elements) and concrete structures lecturer. Since finishing his M. Sc. studies in 1998 he has been involved in different research programmes focusing on steel fibre reinforced concrete

(SFRC), cement composites based on waste aggregate, NDT testing of concrete. As Director of Laboratory of Materials Strength and Civil Building Structures at Kozsalin University of Technology he collaborated with local producers of building materials and helped them achieve certifications enabled European sales of their products. Since 2008 he has been an active member of several organisations as Technical Committee in Polish Committee for Standardization, Polish Chamber of Civil and Structural Engineers and Polish Union of Construction Engineers and Technicians. In 2008 he obtained qualifications to structural design and to supervise construction works with no restrictions. He is an alumnus of “TOP 500 Innovators – science, management, commercialization” programme (University of California Berkeley, USA) and participant of multiple foreign internships (Czech Republic, Romania, Finland). His current research and technical interests cover: properties of concrete and SFRC, durability and serviceability of concrete and SFRC elements, non-destructive testing (NDT) of concrete, SFRC and other cement based composites, green concrete, waste and recycled aggregate. His teaching interests are focused on concrete structure and computer aided structural engineering. As a lecturer has promoted dozens of M.Sc. and Eng. theses. Author of over 30 scientific papers in various fields of concrete technology and concrete structures published in proceedings and journals.

List of chosen publications by Jacek Domski

- Domski J.** (2008) *Cracking of beams with fine aggregate concrete and steel fibres under short time load*. Inżynieria i Budownictwo, no. 6, pp. 316-319.
- Domski J.** (2008) *Load carrying capacity of beams with fine aggregate concrete with steel fibres*. Proceedings, 54 Konferencja Naukowa KILiW PAN i KN PZITB „Krynica 2008”, pp. 165-170.
- Domski J.** (2011) *Cracking moment in steel fibre reinforced concrete beams based on waste sand*. “OVIDIUS” University Annals – Constantza, Series Civil Engineering, Issue 13, pp. 29-34.
- Domski J.** (2011) *Shrinkage and creep of fine aggregate concrete with steel fibres*. Proceedings, VI Konferencja Naukowo-Techniczna „Zagadnienia materiałowe w inżynierii lądowej”. MATDUB’2011, pp. 83-91.
- Domski J.** (2011) *Deflection in steel fibre reinforced concrete beams based on waste sand*. Przegląd Budowlany no. 3, pp. 32-37 (2012).
- Katzer J., Domski J.** (2012) *Quality and mechanical properties of engineered steel fibres used as reinforcement for concrete*. Construction and Building Materials, Vol. 34, 243–248.
- Domski J.** (2012) *Bending moments in steel fibre reinforced concrete beams based on waste sand*. Riga Technical University 53rd International Scientific Conference dedicated to the 150th anniversary and The 1st Congress of World Engineers and Riga Polytechnical Institute / RTU Alumni, 11-12 October 2012, Rīga, Latvija.
- Domski J., Katzer J., Fajto D.** (2012) *Load-CMOD Characteristics of Fibre Reinforced Cementitious Composites Based on Waste Ceramic Aggregate*. Annual Set - The Environment Protection, Vol. 14, 69–80.
- Katzer J., Domski J.** (2013) *Optimization of fibre reinforcement for waste aggregate cement composite*. Construction and Building Materials, Vol. 38, 790–795.
- Domski J., Katzer J.** (2013) *Load-deflection Characteristic of Fibre Concrete Based on Waste Ceramic Aggregate*. Annual Set - The Environment Protection, Vol. 15, 69–80.
- Cichocki K., Domski J., Katzer J., Ruchwa M.** (2013) *The use of waste aggregate in building industry – numerical analysis of fibre reinforced slabs under impact loads*, Proceedings, Nordic Symposium for Energy Efficiency in Buildings, 27 September 2013, Oulu, Finland.
- Katzer J., Domski J.** (2013) *Cement mortars based on sand partially replaced by waste ceramic fume*. “OVIDIUS” University Annals – Constantza, Series Civil Engineering, no. 12, pp. 83–92.



Jacek Katzer – professor of Koszalin University of Technology

D.Sc. Ph.D. M.Sc. B.Sc. qualified, highly experienced technologist of concrete. He has wide expertise as a concrete researcher, mix designer, quality controller of concrete production (both ready-mix and precast elements) and concrete technology lecturer. Since 1994 (finishing M.Sc. studies) he has been continuously involved in technology of concrete as: professional engineer, researcher, quality controller, lecturer, KTP asso-

ciate at The University of Sheffield (UK), director of Laboratory of Building Engineering (Koszalin University of Technology) and European Commission expert. He is an alumnus of “TOP 500 Innovators – science, management, commercialization” programme (Haas School of Business, University of California Berkeley, USA). Since 2011 he is a member of editorial board of “OVIDIUS University Annals – Constantza”, Series: Civil Engineering. His current research and technical interests cover: green concrete, waste and recycled aggregate, static and dynamic properties of concrete, SFRC and SIFCON, durability and serviceability of concrete and fibre reinforced concrete, non-destructive testing (NDT) of concrete, fibre reinforced concrete and other cement based composites, modern and traditional brickwork, modern and traditional mortars, non-steel reinforcement for concrete elements and structures. His teaching interests are focused on technology of concrete, technology and application of building materials. Since 2006 he is a member of International Society for Concrete Pavements (USA). Apart from research and testing activities he has promoted dozens of M.Sc. and Eng. theses, most of which were purely research and innovative. Author of over 90 scientific papers in various fields of concrete technology published in proceedings and journals (in English, in German, and in Polish – see a list of chosen publications below).

List of chosen publications by Jacek Katzer

Katzer J., Kobaka J. (2006) *The assessment of fine aggregate pit deposits for concrete production*. Kuwait Journal of Science and Engineering. Vol. 33, 165–174.

Katzer J. (2008) *Properties of Precast SFRCC Beams Under Harmonic Load*. Science and Engineering of Composite Materials. Vol. 15, 107–120.

Katzer J., Kobaka J. (2009) *Influence of Fine Aggregate Grading on Properties of Cement Composite*. Silicates Industriels. Vol. 74, 9–14.

Katzer J., Kobaka J. (2009) *Combined Non-Destructive testing Approach to waste Fine Aggregate Cement Composites*. Science and Engineering of Composite Materials. Vol. 16, 277–284.

Katzer J., Kobaka, J. (2010) *Harnessing Waste Fine Aggregate for Sustainable Production of Concrete Precast Elements*. Annual Set - The Environment Protection. Vol. 12, 33-45.

Katzer J. (2011) *Impact and dynamic resistance of SFRCC modified by varied superplasticizers*. Archives of Civil and Mechanical Engineering. Vol. 11, 103–113.

Katzer J., Dowski J. (2012) *Quality and mechanical properties of engineered steel fibres used as reinforcement for concrete*. Construction and Building Materials, Vol. 34, 243–248.

Katzer J. (2012) *Median diameter as a grading characteristic for fine aggregate cement composite designing*. Construction and Building Materials, Vol. 35, 884–887.

Katzer J. (2012) *Impact Resistance of Sustainable SFRCC Road Pavement*. Baltic Journal of Road and Bridge Engineering. Vol. 7, 198–203.

Katzer J., Dowski J. (2013) *Optimization of fibre reinforcement for waste aggregate cement composite*. Construction and Building Materials. Vol. 38, 790–795.

Katzer J. (2013) *Strength performance comparison of mortars made with waste fine aggregate and ceramic fume*. Construction and Building Materials, Vol. 47, 1–6.

Dowski J., Katzer J. (2013) *Load-deflection Characteristic of Fibre Concrete Based on Waste Ceramic Aggregate*. Annual Set - The Environment Protection. Vol. 15, 69–80.

Ponikiewski T., Katzer J. (2014) *Properties of fresh SCC mix reinforced by different types of steel and polymer fibre*. Construction and Building Materials. Vol. 62, 96–101.

Ponikiewski T., Katzer J., Bugdol M., Rudzki M. (2014) *Determination of 3D porosity in steel fibre reinforced SCC beams using X-ray computed tomography*. Construction and Building Materials. Vol. 68, 333–340.

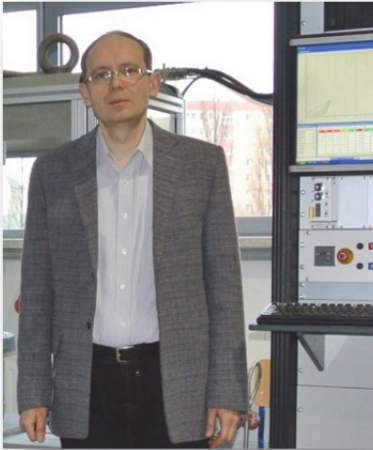

Mariusz Ruchwa – assistant professor of Koszalin University of Technology (Poland), Department of Structural Mechanics, Faculty of Civil Engineering, Environmental and Geodetic Sciences.

His area of interest covers Structural Mechanics problems concerning numerical methods, nonlinear static and dynamic analysis of structures subjected to impulsive loads, constitutive material models for concrete, metals, composites, and general problems of Finite Element Method analyses of complex engineering phenomena including analysis of damages due to high intensity loading.

Mariusz Ruchwa in an academic lecturer in Koszalin University of Technology since 1990. He defended with award his PhD thesis in 2001, and completed many professional courses (ABAQUS and ANSYS computer code applications in FEM, *Summer Course on Mechanics of Concrete* organized by Polish Academy of Sciences, etc.). He participated also in realization of many scientific projects concerning his area of interest: *Analysis of stability and integrity of multi-storey buildings subjected to exceptional loads* 457/N-COST/2009/0, COST TU0601 „*Robustness of Structures*”, *Impact resistant concrete elements with nonconventional re-inforcement* 2011/01/B/ST8/06579.

The results of his research have been presented at many scientific conferences and meetings (for example: *International Conference on Computer Methods in Mechanics*). Author of over 50 scientific papers published in conference proceedings and journals. He was several awarded by the Rector of Koszalin University of Technology for his scientific and organisational activity. His students were recognized several times for their B.Sc and M.Sc theses.

List of chosen publications by Mariusz Ruchwa

- Cichocki K., Ruchwa M.** (2013) *Integrity analysis for multistorey buildings*. Ovidius University Annals - Constantza. Series: Civil Engineering. Constantza, Romania: Ovidius University Press, (15), pp. 45-52.
- Cichocki K., Ruchwa M.** (2013) *Numerical analysis of fibre reinforced slabs under impact loads*. In: *20th International Conference on Computer Methods in Mechanics, CMM-2013. Short Papers*. Poznań, Poland, 27-31 August 2013. Poznań: Poznań University of Technology. pp. 379-380.
- Kulesza U., Ruchwa M.** (2013) *Application of XFEM in analysis of damage development in concrete beam*. In: *Poliptymalizacja i Komputerowa Pomoc w Projektowaniu. t. XI*. Kiczkowiak, T., Tarnowski, W. (eds.) Koszalin University of Technology, pp. 121-131 (in Polish).
- Cichocki K., Ruchwa M.** (2011) *Propagation of damages in structures under blast load*. *Zeszyty Naukowe Politechniki Rzeszowskiej. Budownictwo i Inżynieria Środowiska*, 58(3/11/III), pp.17-24 (in Polish).
- Ruchwa M.** (2011) *Application of elements made of metallic foams for the structural protection against impulsive loads*. In: *57th Annual Scientific Conference on SCIENTIFIC PROBLEMS OF CIVIL ENGINEERING. PROCEEDINGS*. Krynica, Poland, 18-22 September 2011. Rzeszów: Rzeszow University of Technology. pp. 108-109.
- Głodkowska W., Ruchwa M.** (2010) *Static analysis of reinforced concrete beams strengthened with CFRP composites*. *Archives of Civil Engineering*, LVI(2), pp. 111-122.
- Ruchwa M.** (2010) *Assessment of reinforced concrete structure resistance to blast*. *Biuletyn Wojskowej Akademii Technicznej*, LIX(4), pp. 269-280 (in Polish).
- Cichocki K., Ruchwa M.** (2001) *Numerical analysis of concrete slabs subjected to blast loading*. In: *European Conference on Computational Mechanics, ECCM-2001*. Cracow, Poland, 26-29 June 2001, pp.572-573.
- Cichocki K., Ruchwa M.** (2000) *Steel stiffened plates subjected to a blast load*. *JOURNAL DE PHYSIQUE IV*, (10), pp. 535-540.
- Cichocki K., Adamczyk R., Ruchwa M.** (1999) *Material modelling for structures subjected to impulsive loading*. *Computer Assisted Mechanics and Engineering Sciences*, 6(2), pp. 231-244.
- Adamczyk R., Cichocki K., Ruchwa M.** (1998) *Effect of protective coating on underwater structure subjected to an explosion*, *Computational Modelling of Concrete Structures, Euro-C IV*, Badgastein, Austria, April, 623-631