

Performance Analysis of the Cognitive Radio Network with Opportunistic Spectrum Access

Radosław Chęciński, Anna Kaszuba-Chęcińska, Michał Kryk, Jerzy Łopatka,

Krzysztof Malon, and Paweł Skokowski

Abstract—Efficient access to the spectral resources becomes a challenge for future military wireless communication systems. It requires spectral situation awareness, knowledge of current regulations, local policies and hardware platform limitations. It can be achieved by cognitive radios, realizing cognitive cycle, consisting typically of continuous observation, orientation, reasoning and decision making. All these elements must be realized in parallel and shouldn't interfere with each other. Even more difficult issue is related with cooperation between different nodes, especially in wireless domain, in harsh propagation conditions. Unpredictable phenomena create hard conditions for all deterministic behavior models, and their reproduction is a key element for efficient operation of the network. Very popular computer simulations are always simplified, and real time implementation gives an opportunity to make the next step in system elaboration. This paper presents a real-time demonstrator of cognitive radio network. It can work both in wired mode, using radio channel emulator and in mobile mode, to verify influence of real conditions on proposed cognitive solutions and assess their effectiveness.

Keywords—MANET, Cognitive Radio, Dynamic Spectrum Access, USRP, RF switch matrix, Real time demonstrator

I. INTRODUCTION

THE literature on Cognitive Radio (CR) is quite vast and in recent years it has covered many aspects of that issue. The core idea of cognitive radio is based on the cognition cycle proposed by Mitola [1]. An overview of the major achievements, developments and the most important challenges in the field of Cognitive Radio is presented in [2], and the general view on CR with the main emphasis on decision making and learning can be found in [3]. According to the cognition cycle, the radio must be firstly aware of its environment. It should sense its surroundings and identify all types of Radio Frequency (RF) activities. Next, the decision making process is executed and the appropriate actions are performed. A very important factor that distinguishes these radios from legacy ones is the ability to learn from their past actions. In [4] four main aspects of cognitive radios are presented: observation, adaptation, reasoning and learning. Reasoning uses the

knowledge, which is provided by the knowledge database and learning algorithm, to achieve certain goals. The authors in [5] investigate the differences between reasoning and learning, and the fundamentals of selection when a particular application requires learning, and when simple reasoning is sufficient. Generally, learning is necessary in the case when effects of the inputs on the outputs of a given system are not known.

One of the widely developed CR technology to alleviate the spectrum scarcity problem and increase spectrum utilization is a Dynamic Spectrum Access (DSA) [6][7]. There are three main DSA models: interwave spectrum access, underlay spectrum access and overlay spectrum access. In addition to this, the centralized the decentralized approaches could be considered. In this paper an interwave model, also called Opportunistic Spectrum Access (OSA), with the decentralized concept is used.

One of the key functionalities of the Cognitive Radio (CR) network is spectrum sensing, used for detection of spectrum holes (white spaces). Based on the achieved results from the Sensing Block (SB), CR network can more efficiently manage radio resources Spectrum Management (SM) in order to adapt to different transmission conditions, and increase flexibility of used radio channel changes. The flexibility of this layer is also required to dynamically adapt the coding scheme, modulation type and throughput. Monitoring of spectrum occupancy allows to use radio resources more efficiently and to modify network behavior depending on radio conditions change [1][8].

Detection of radio spectrum must cope with many drawbacks occurring in the radio environment, such as shadowing or the hidden node problem, which causes a limited ability to sense signal effectively. These problems can be overcome by introduction of cooperation between CR nodes. The solution is to make decisions on the basis of reports received from a number of CR nodes. Based on the reports received from many radio nodes, a decision of whether a signal is present or not may be taken, even if some of the CR nodes were not able to properly detect occurring transmission (e.g. due to the large distance from the signal source or shadowing effect) [9][10].

In the second section a system architecture is described. The next part includes a testbed presentation. Then the scenario assumptions and obtained results are provided. The last section concludes the paper and depicts direction for future work.

II. SYSTEM DESCRIPTION

The proposed system architecture is based on the clustered network (Fig. 1). In each cluster, there is one main node named Cluster Head (CH), which is responsible for managing its group (information aggregation and decision making process), and other nodes are called Ordinary (ORD) nodes.

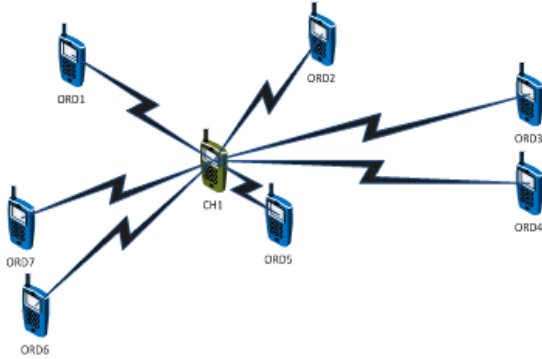

Fig. 1. An example cluster structure with 8 nodes (1 Cluster Head and 7 Ordinary nodes).

The structure of Cognitive Radio node is presented in Fig. 2 and consist of three basic elements: transmitting module (TX), receiving module (RX) with Sensing Block (SB) and Cognitive Manager (CM).

The sensing block in the CR can monitor available bandwidth using discrete out-band sensing. Using the out-band method, the CR monitors radio channels which are currently not used for radio transmission. The aim of this approach is to provide functional alternative channels, which can be used in case of disruption, interference or the existence of other factors preventing the transmission on the CR's own channel. Discrete detection involves sensing at specific, predefined moments of time, and during assumed period of time. In this case, situation awareness of CR is actual up to that moment in time.

Elaborated implementation contains CR nodes with elements responsible for situation awareness. Sensing Client (SC) is a logic module, which manages the work of SB and cooperates with the Cognitive Manager. SC sends to the CM information about alternative channels, which would allow proper

transmission, along with detection results, and directs the SB to monitor new channels (Fig. 2).

SC module can perform detection on selected channels with defined periodicity in TDMA frame structure containing 10 time slots. According to defined policy, it is possible to reserve from 1 up to 4 time slots for sensing. SB is an execute module and performs the task of detection incoming from SC. SC defines parameters for sensing preparation like:

- probability of false alarm (P_{fa}),
- number of slots for sensing (NumberOfSlots),
- detection periodicity in frames,
- channel number to monitor (Ch2Monitor),
- detector type: the single channel energy detector or the multichannel Weighted Overlap Add (WOLA) detector with energy detector for each subchannel [12][13].

The data exchanged within the node contain information on:

- new channel for transmitting module,
- new channel for receiving module and Frame Error Rate (FER) of received packets,
- new selected channel to exclude out-band sensing and local detection results from SC,
- sensing parameters and results.

The proposed algorithm assumes that each CR node performs local observation of electromagnetic environment based on out-band sensing of alternate channels and monitoring actually used channel by controlling FER.

For the developed implementation, the authors decided to implement centralized cooperative sensing. CH collects detection results from ORD, identifies available bandwidth and sends information back to ORDs. This solution was selected to reduce influence of the radio channel fading and increase detection efficiency [11].

Cognitive Manager in Cluster Head aggregate detection results from all nodes and prepare the backup channels list. This set, which contains currently the best channels, is then send to ORD nodes for potential use in the future in case of communication problems caused e.g. by intentional jamming. Therefore, this approach is a proactive solution. The decision making process regarding the need to change actually used channel can be taken in each CR node based on FER metric.

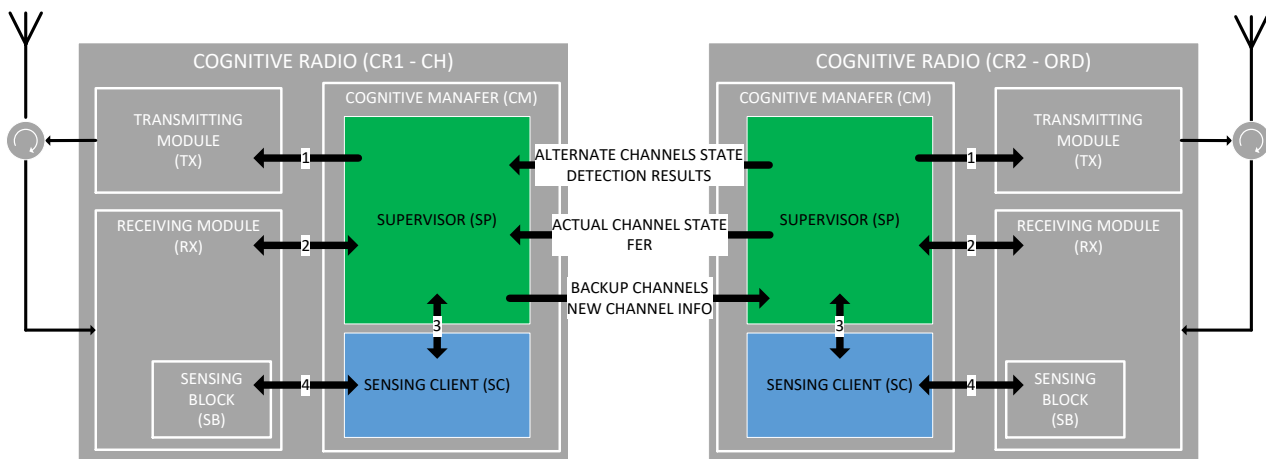

Fig. 2. Cognitive radio structure with data flow within the node and between Cluster Head and Ordinary nodes.

III. TESTBED

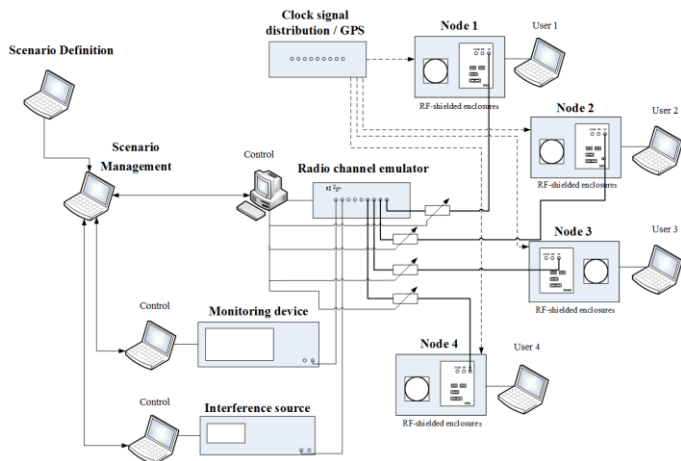

Fig. 3. Architecture of MANET testbed

The architecture of Mobile Ad-Hoc Network (MANET) testbed consists of (Fig. 3):

- Scenario definition station,
- Scenario management station,
- Radio channel emulator station,
- Radio nodes,
- Interference station,
- Monitoring station,
- Clock signals distribution / GPS.

Actual implementation of MANET testbed is shown on Fig. 4.

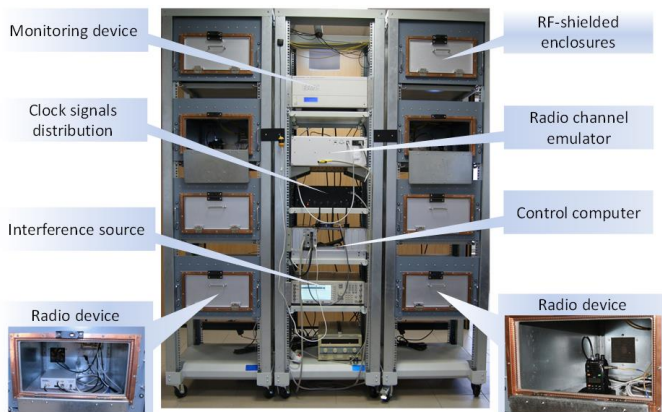

Fig. 4. Implementation of MANET testbed

A. Scenario definition station

The first step in testing proposed solution is scenario definition. It is implemented on the station which consists of PC and scenario application. Scenario application generates a pack of configuration files, which is passed to scenario management station. This pack is necessary to configure all stations in MANET testbed. It includes basic data scenario (scenario area, duration), a list of frequency channels, definition of nodes

(nodes number, node type and mobility), activity of jamming node, propagation database etc.

B. Scenario management

The station which controls the entire process of scenario realization is called scenario management station. It consists of PC and scenario management application. The application allows the user to select the scenario that was previously prepared and initiate the next steps of test by sending control commands to each station. All steps and events that occur during the scenario realization, user can observe in GUI (Fig. 5).

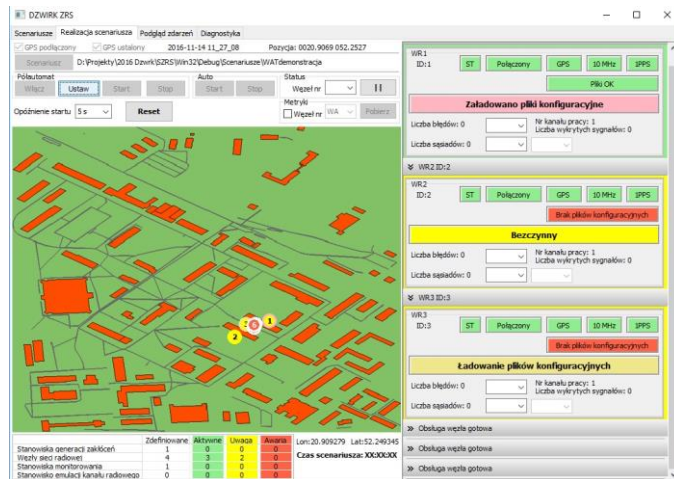

Fig. 5. Scenario management application

C. Radio nodes

Radio node consist of Universal Software Radio Peripheral (USRP) connected to computer via LAN interface. Software installed on computer is responsible for USRP configuration, scenario realization and real-time waveform processing. This software uses USRP Hardware Driver (UHD) to perform communication with USRP device and liquid-dsp library to implement physical layer of the waveform.

The radio node software has modular structure. The main modules are: waveform, remote control, metrics collecting, logger. Application does not provide graphical user interface. The information on application status is displayed in linux terminal.

Waveform module, executing radio data processing functions, has implemented four layers of OSI model and also radio node cognitive functions. Waveform architecture is presented on Fig. 6. Each of physical, network, MAC and application layer consist of manager and signal processing module. Sensing module has interface with physical layer, to enable IQ samples transfer from device, and interface to cognitive manager, to provide data about sensing results. Cognitive manager has also interfaces to MAC and physical layer for management purposes.

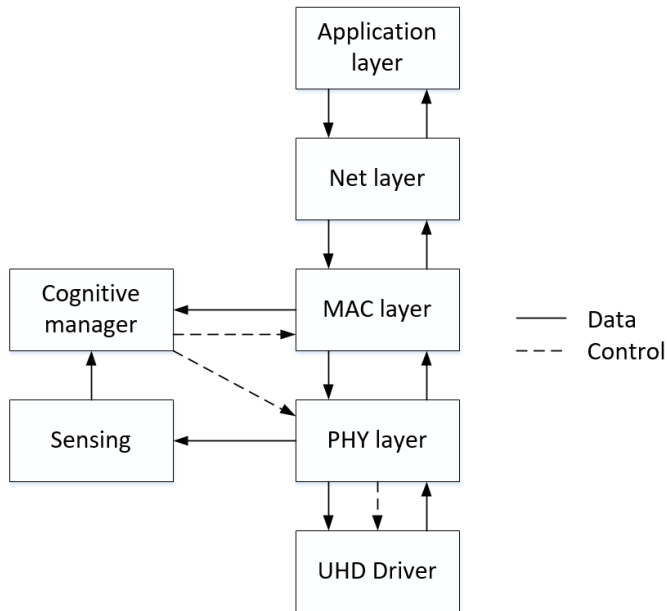

Fig. 6. Waveform architecture

D. Radio channel emulator station

This station emulates the symmetrical telecommunication channel. It consists of RF switch matrix, PC and control application. This application adjusts attenuations of specific paths. In result the matrix generates slow and fast fading with dynamic attenuation changes equal to 95 dB and switching time up to 2 us. It has the ability to connect up to 9 nodes with possible frequency range from 30 MHz to 3 GHz [14].

E. Interference station

This station is responsible for generating jamming signal during the scenario realization. All its activities, including signal shape, frequency and bandwidth are defined in the scenario file. This station consists of arbitrary function generator Agilent E4438C, PC and control application.

F. Monitoring station

This station is responsible for radio monitoring and signal recording during the scenario realization. Therefore, the user can preview the received signal in real time. This station consists of R&S ESMD receiver (monitoring device), PC and control application. Monitoring device works in frequency range from 20 MHz to 3,6 GHz and real-time bandwidth up to 80 MHz. It has numerous operation modes e.g. fixed and sweep frequency that should be used for larger monitoring band. Additionally, in order to achieve greater stability of time and frequency in monitoring devices, rubidium oscillator synchronized with the GPS signal is used.

IV. RESULTS

Tests of implemented algorithms were performed using prepared scenario with defined nodes type, their positions and frequency bandwidths available for cognitive nodes.

The structure of mobile network, defined in scenario, consisted of 4 cognitive nodes (realized data transmission and cognitive algorithms), one monitoring node, one defined jammer (which activity time was defined in scenario) and one external jamming node (turned on during arbitrary selected period of scenario time). Additionally, available radio frequency channels were defined (TABLE I).

TABLE I
RADIO FREQUENCY CHANNELS

Channel ID	Frequency [MHz]
1	400
2	412
3	424
4	436
5	448
6	460

Attenuations between radio nodes were changing and their values depended on radio nodes' position, distance between them and the terrain profile. Initial positions of radio nodes and their route path are presented on Fig. 7. Fig. 8 presents attenuations between CR nodes (1 – 4) and jammer (5) during scenario time. The attenuation changed dynamically in the range from -60 dB to -105 dB. Taking into account path losses, one can see that it is not possible to detect jammer activity by all nodes during scenario realization. CR 1 was not able to detect any jamming signal but CR 2 and CR 3 could detect signal only in some periods (CR 2: 45 – 50 [s] and 80 [s], CR 3: 0 – 60 [s]). Only CR 4 effectively detected all signals from the interference station. Global decision about the signal presence was based on aggregated data. Cooperative sensing method increases the detection probability and reduces influence of shadowing effect phenomena.



Fig. 7. Nodes' movement

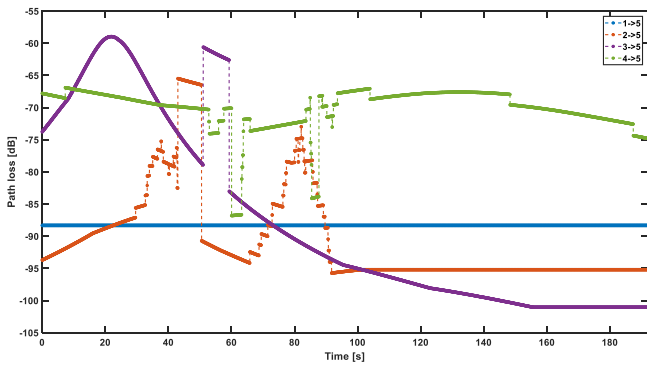

Fig. 8. Attenuation between nodes versus time

TABLE II presents a percentage number of received valid packets in the destination node, relatively to all packets transmitted by source node in electromagnetic environment with jamming signals, urban area, changing distances between nodes and different terrain profiles. These parameters show that network responded for activity of jamming signals because nodes received packet in about 80%. Results are different for all relations and they depend mainly on distance between nodes (nodes received invalid packets (or no packets) when the radio path attenuation was too high).

TABLE II
PACKETS TRANSMISSION EFFICIENCY

Source \ Dest.	1	2	4	5
1	-	66,67 %	85,61 %	86,36 %
2	91,28 %	-	92,29 %	40,35 %
3	79,11 %	97,56 %	-	92,42 %
4	93,87 %	89,02 %	92,23 %	-

Fig. 9. presents network traffic analysis between node 3 and 4. Graph 1 (the first from the top) presents calculated path loss defined in the scenario and Received Signal Strength Indication (RSSI) level of signal received by USRP device. The conclusion is that RF switch matrix and USRP RF tuners are working properly, because they match to each other. The second graph presents activity of nodes 3 (red color), 4 (green color) and jamming node (blue color). Results show that nodes properly responded to the jamming activity (they were changing frequency channel when jammer started transmitting). The third and fourth graph present packet error rate and number of bits transmitted in specified window time.

Fig. 10. presents type of packet exchanged between node 2 (ORD node) and 1 (CH node). During the test, most traffic were DATA packets (92 %). Additionally, ORD nodes were transmitting HELLO packets (to perform neighbor discover service) and SENSING/SENSING DATA packets to report cluster head about sensing results and user results (in SENSING DATA frame sensing results and user data were transmitted).

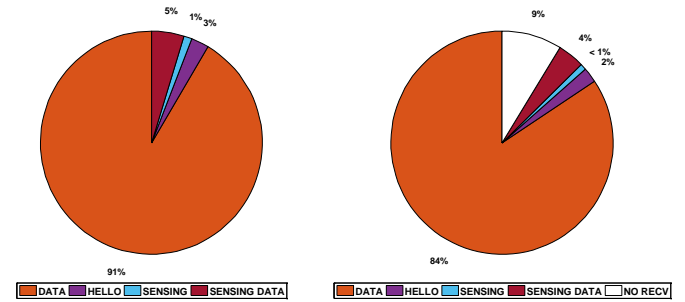

Fig. 10. Packet types exchanged between node 2 and 1 (left – send from node 2, right – received by node 1)

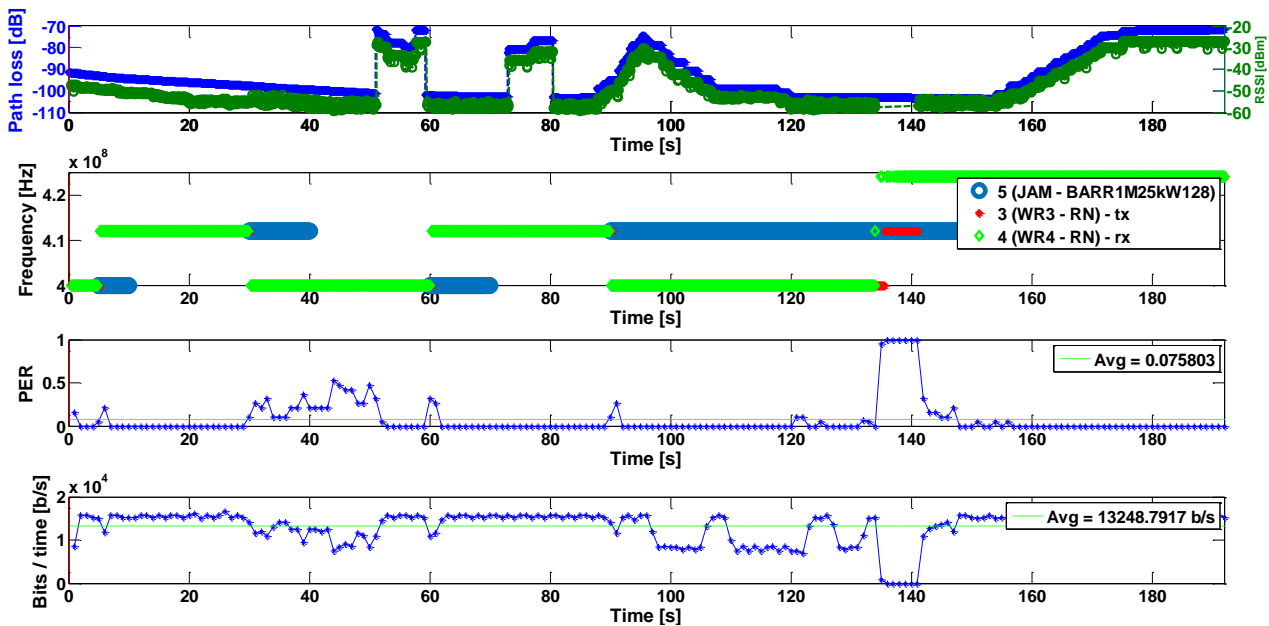

Fig. 9. Network traffic analysis between node 3 and 4

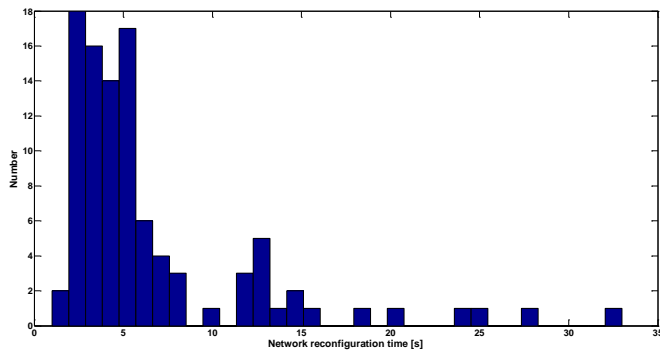

Fig. 11. Network reconfiguration time

Fig. 11. presents network reconfiguration time. This time is measured from the time of start jammer activity to time where network performed synchronization after channel change. This time mainly equals about 3-6 seconds. The longer times are caused by too long distance between nodes and Non Line Of Sight conditions.

V. CONCLUSIONS

The elaborated real time demonstrator of the cognitive radio network enables analysis of MANET performance in predefined scenarios. Programmable traffic generators are used for variable loading the network to achieve different operational cases, whereas RF switch matrix gives repeatable propagation conditions, and collected metrics gives a possibility for versatile analysis of the network behaviour and successive upgrades of cognitive radio elements.

One of them is sensing block, using cooperative spectrum sensing that greatly reduces the missed detection probability and the probability of false alerts. Based on the results received from many cognitive radio nodes CH can decide whether a signal is present in a given radio frequency even if not all network nodes detect that signal (e.g. due to a large distance from the source or signal, shadowing effect etc.). Global decision about the presence of the signal on the radio channel is taken on the basis of data aggregated in the CH. Aggregated results are used to decide about the presence or absence of a signal in the radio channel.

The demonstrator can also work in mobile mode, where no RF matrix is used. This mode can be used for verification of proposed solution in a real time.

Further plans of the demonstrator use are related with policy based radios, multispectral systems analysis and heterogeneous software defined networks implementation.

REFERENCES

- [1] J. Mitola, G. Q. Maguire, "Cognitive radio: making software radios more personal", *IEEE Personal Communications*, 6, pp. 13 – 18, 1999.
- [2] J. Palicot, J. Mitola, Z. Lei, F. K. Jondral, "Special issue on 10 years of cognitive radio: state-of-the-art and perspectives", *EURASIP Journal on Wireless Communications and Networking*, 2012, 2012:214.
- [3] W. Jouini, Ch. Moy, J. Palicot, "Decision making for cognitive radio equipment: analysis of the first 10 years of exploration", *EURASIP Journal on Wireless Communications and Networking*, 2012, 2012:26.
- [4] L. Gavrilovska, V. Atanasovski, I. Macaluso, L. A. DaSilva, "Learning and reasoning in cognitive radio networks", *IEEE Communications Surveys & Tutorials*, 15(2013), 1761 – 1777.
- [5] C. Clancy, J. Hecker, E. Stuntebeck, T. O'Shea, "Applications of machine learning to cognitive radio networks", *IEEE Wireless Communications*, 14(2007), 47 – 52.
- [6] M. Song, C. Xin, Y. Zhao, X. Cheng, "Dynamic spectrum access: from cognitive radio to network radio", *IEEE Wireless Communications*, 19, pp. 23 – 29, 2012
- [7] P. S. M Tripathi, A. Chandra, A. Kumar, K. Sridhara, "Dynamic spectrum access and cognitive radio," 2nd International Conference on Wireless Communication, Vehicular Technology, Information Theory and Aerospace & Electronic Systems Technology, Chennai, 2011, pp. 1 – 5
- [8] H. Arslan, "Cognitive radio, software defined radio, and adaptive wireless systems." Dordrecht: Springer, 2007.
- [9] K. Sithampanathan, A. Giorgetti, "Cognitive Radio Techniques: Spectrum Sensing, Interference Mitigation, and Localization," Artech House, 2012
- [10] T. Yücek and H. Arslan, "A survey of spectrum sensing algorithms for cognitive radio applications," *IEEE Commun. Surv. Tutor.*, vol. 11, no. 1, pp. 116–130, 2009.
- [11] P. Skokowski, K. Malon, J. M. Kelner, J. Dolowski, J. Lopatka, P. Gajewski, "Adaptive channels' selection for hierarchical cluster based cognitive radio networks," 8th International Conference on Signal Processing and Communication Systems, Gold Coast, 2014, pp. 1 – 6.
- [12] Wang, H., Youxin, L. and Wang, X., "Channelized Receiver with WOLA Filterbank," *CIE International Conference on Radar* (2006).
- [13] Abdulsattar, M. A. and Hussein, Z. A., "Energy detection technique for spectrum sensing in cognitive radio: a survey," *International Journal of Computer and Communications*, Vol.4, No.5, 223-241 (2012).
- [14] M. Kryk, J. Łopatka, "Radio environment simulation using RF switch matrix for MANET tests", *Signal Processing and Communication Systems*, (2014)