



MARINE DIESEL ENGINE COMMON RAIL INJECTORS MONITORING WITH VIBRATION PARAMETERS

Marcin KLUCZYK¹, Andrzej GRZĄDZIELA²

^{1,2}Polish Naval Academy Mechanical-Electrical Department, Śmidowicza 69 st. 81-127 Gdynia, Poland.
¹m.kluczyk@amw.gdynia.pl, ²a.grzadzIELa@amw.gdynia.pl

Abstract

The paper presents a results of vibration tests of common rail injectors operating in diesel engines. The most common methods of diagnosing common rail injectors (CR) as well as the most common damage of injectors of this type have been described. The results and analyzes of tests obtained during measurements on two different test stands were presented. Obtained results allowed for the preliminary determination of diagnostically sensitive parameters, which may allow the development of the injector diagnostics method without the need to stopping the engine.

Key words: marine engines, diagnostics, vibrations, Common Rail injectors

KONTROLA STANU TECHNICZNEGO WTRYSKIWACZY COMMON RAIL SILNIKÓW OKRĘTOWYCH NA PODSTAWIE POMIARÓW PARAMETRÓW DRGANIOWYCH

Streszczenie

W artykule przedstawiono wyniki badań drganiowych wtryskiwaczy Common Rail pracujących w silnikach o zapłonie samoczynnym zasilanych. Opisano najpowszechniej stosowane metody diagnozowania wtryskiwaczy Common Rail (CR), jak również najczęstsze uszkodzenia wtryskiwaczy tego typu. Zaprezentowano wyniki i analizy badań uzyskane podczas pomiarów na dwóch różnych stanowiskach testowych. Uzyskane wyniki pozwoliły na wstępne określenie parametrów wrażliwych diagnostycznie, co może pozwolić na opracowanie metody diagnostyki wtryskiwaczy bez potrzeby zatrzymywania silnika.

Słowa kluczowe: silniki okrętowe, diagnostyka, drgania, wtryskiwacze Common Rail

1. INTRODUCTION

Due to the increasingly stringent emission standards set out in Marpol Annex VI and other documents issued by the IMO (mainly by the MEPC - Marine Environment Protection Committee), designers of modern marine engines were forced to introduce solutions to control the combustion process in them. The most commonly introduced solution (not only in relation to marine engines) is the use of injection equipment operating in the common rail system. The main difference compared to the classic mechanical injection equipment is using one pump producing high pressure of 140-250 MPa and feeding all electronically controlled injectors from one fuel rail. Despite many undoubted advantages of such a solution, its main disadvantage is electronically controlled injectors relatively high failure rate. Currently, two types of injectors are used, piezoelectric and electromagnetic injectors. In the first group, the opening of the injector is caused by changing the volume of the piezoelectric stack. The second solution which will be the object of further consideration is characterized by the control by

means of an electromagnetic phenomenon created in the coil.

Operational problems resulting from the use of electronically controlled common rail injectors result mainly from the very high precision of their components and the degree of complexity of the injector, which is larger than in the classical injection equipment. CR injectors can be precisely controlled and tested on the test bench under laboratory conditions, whereas in "field conditions" their diagnosis is practically limited to measuring the volume of fuel flowing out of the control chamber of individual injectors or from all injectors at the same time [1, 8]. It follows that the personnel operating the engine on board a navy ship have very limited possibilities to determine the technical condition of the injectors. In most cases, it leads to a decision to replace the set of injectors of a given engine. Unfortunately, the costs of such an operation often constitute a serious expense for the shipowner. Lack of proper diagnostic tools on board the ship may also lead to a situation when the damaged injector will be still in operation, which in turn may cause serious damage to the entire engine.

Common rail injectors are more and more often used in dual fuel engines (diesel oil and gas fuel) [16]. In this case, they are even more vulnerable to damage and disturbances in their operation are also caused by disturbances in the combustion of gaseous fuel. Therefore, there is a strong need to develop methods for an effective and non-invasive method to assess the technical condition of CR injectors. A lot of authors working with this problem [1-7, 9, 11, 12, 15, 17-24] but still an universal vibration diagnostic fuel injection systems is not implemented

2. CONSTRUCTION OF ELECTRODYNAMICALLY CONTROLLED CR INJECTORS

In the case of high-speed and medium-speed engines, used CR injectors (electrodynamically controlled), structurally and functionally are very similar to injectors operating on the same principle in the automotive industry. In the case of engines fueled with heavy fuel, there are significant differences in the construction of Common Rail injectors due to the significantly higher viscosity of residual fuels. The comparison of the MAN high-speed injector engine structure (injector is manufactured by L'Orange) and the Bosch injector from car engines was presented on Figure 1 [21].

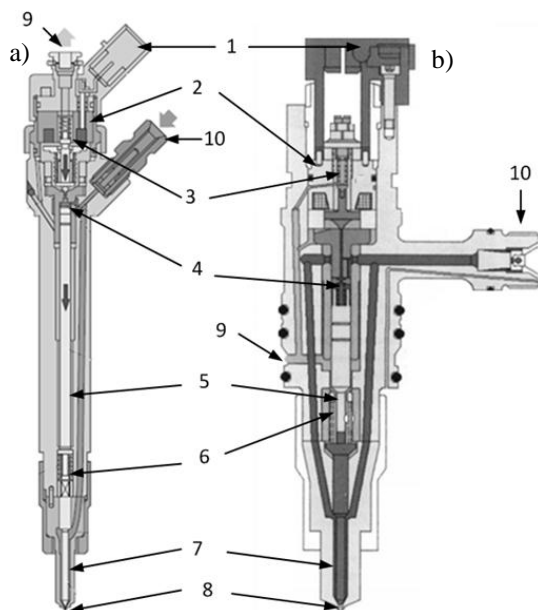

Fig. 1. Comparison of the construction of the MAN high-speed marine engine - b) [23] injector and the Bosch injector from car engines - a) [22]. 1 – electrical connection, 2 – coil, 3 – valve spring, 4 – valve control chamber, 5 – valve control plunger, 6 – needle spring, 7 – nozzle, 8 – atomizer, 9 – fuel return, 10 – high pressure fuel inlet

The main difference in the construction of the two presented injectors is based on a different method of regulating the spring tension of the control valve. In Polish Navy, light fuel is used, hence the conclusion that injectors used in new

engines assembled on Polish Navy ships will be similar to those from the automotive industry. The comparison of the injectors used by MTU is presented in figure 2. The analysis of the current needs of the Polish Navy results from and applies to series engines from 1100 to 4000 (some of these engines is already mounted on board of ships).

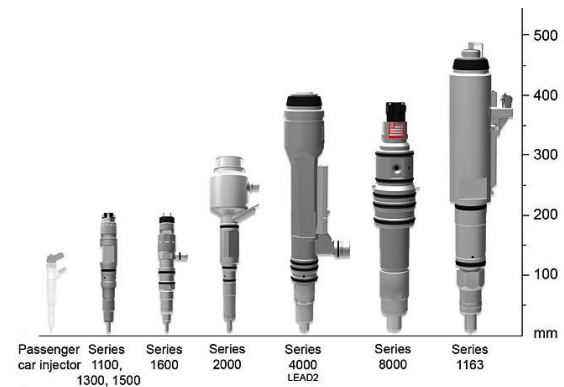

Fig. 2. Common Rail injectors used by MTU [21]

Despite the differences in the construction of CR system injectors and typical injectors in both cases, the main source of vibrations recorded on their hulls are phenomena associated with the lift and fall of the injector needle related to the opening and closing of the injector. The equation describing dynamics of the Common Rail injector needle according to [10] is:

$$m_i \frac{d^2 h_i}{dt^2} + (c + c_1 + c_2) \frac{dh_i}{dt} + (k + k_1 + k_2) h_i = F_{tr} - F_0 - F_{cr} + p_{II}(A_{II} - A_{III}) + p_{III}(A_{III} - A_{IV}) + p_{IV} A_{IV} \quad (1)$$

where:

m_i – needle mass; c – needle motion viscous damping coefficient; c_1 – upper needle seat damping coefficient; c_2 – lower needle seat damping coefficient; k – spring coefficient for nozzle valve spring; k_1 – spring coefficient for upper nozzle valve seat; k_2 – spring coefficient for lower nozzle valve seat; F_{cr} – coil force; F_{tr} – friction force between nozzle body and needle; F_0 – initial spring tension for needle; p_{II} , p_{IV} – pressures acting on needle presented on fig. 3; A_{II} – area of needle in cross-section II; A_{III} – area of needle in cross-section III; A_{IV} – area of needle in cross-section IV.

Taking into consideration the right side of the equation (1) and the construction of Common Rail injectors it can be stated that mechanical damage will result in pressure changes in the different parts of the injector nozzle. Mechanical damage to the control valve will result in a drop of pressure in the control chamber. As a consequence, changes in the technical condition of the injector must alter to the parameters of the needle's movement, which in turn will affect as changes of dynamic parameters recorded on the injector body. Changes in the initial spring tension for the needle on the right side of the equation (1) results in stiffness changes in the left side of the equation. This implies a reduction of

energy dissipation assuming a constant efficiency of the device. Analyzing the structure of the dissipated energy can be assumed injector vibroactivity reduction.

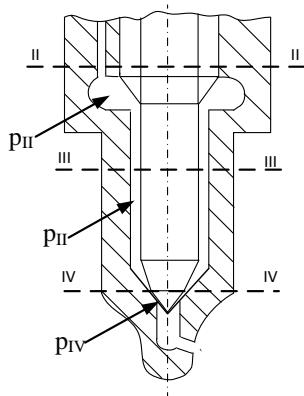

Fig. 3. Distribution of individual pressures in the injector's nozzle

3. COMMON RAIL INJECTORS THE MOST COMMON DAMAGES

CR injectors in accordance with available literature [8, 14, 15] are the most breakdown element of the fuel supply system of modern diesel engines. Injector damage can be divided into three main groups: damage to electrical and electronic components that are relatively easy to detect even without the need to disassemble the injector from the engine. The next group is damage to the injector's hull and its external elements, usually it is possible to diagnose after disassembling from the engine and thoroughly cleaning the injector. The last group of damages is damage to their internal components in most cases impossible to detect outside specialized repair workshops. According to the data presented by [14, 15], the most frequent internal damages of Common Rail injectors elements include all kinds of damage to the control valve consisting in loss of tightness of the pair valve-seat. This results in a change in the characteristics of the fuel injection process. The most common cause of such damage is poor fuel quality, especially the presence of water or mechanical impurities. Another group of damages are control piston damages consisting mainly of the formation of scratches and corrosion on its surface caused by the presence of solids or water in the fuel. The nozzles of the injectors are also damaged, mainly due to difficult operating conditions and the associated exposure to high temperatures occurring in the engine's combustion chamber. The last group of failures significant from the diagnostics point of view are damages to the injector's needle consisting of its erosion, corrosion or seizure. In this case, the poor quality of fuel fed to the engine is also the most common cause.

In conclusion, it should be noted that the most common cause of CR injectors damage is poor fuel quality. This issue is extremely important

considering the conditions of operation of navy engines, where they are exposed to contact with contaminated fuel. It should be emphasized that the most common contamination occurring in light marine fuel (in NATO, fuel type F-75) is water accumulating in storage tanks as well as in daily tanks.

4. INSPECTION OF INJECTORS TECHNICAL CONDITION

CR injectors technical control can be carried out in various ways. The simplest test that does not require disassembly of the injector from the engine is verification of injector electrical control signals. It is necessary to use an oscilloscope or a diagnostic device dedicated for a given engine brand. Another test is to check the amount of fuel overflowed by the injector, thanks to which it can be evaluated the condition of the control valve [9, 14, 15]. The best and usually reliable method is to dismantle the injectors from the engine, wash them in ultrasonic washers and test at special workstations to check the operation of the injector in selected operating conditions. Vibration tests of the investigated by authors injectors were carried out on the NT 816C test bench. The stand, the fragment of which can be seen in Figure 4, enables testing of the most brands injectors. Injector tests were first conducted to detect failures and deviations from the nominal parameters of the eight Common Rail injectors coming from the AR 32501 engine. The injectors type 0445110002 were tested, which normally cooperate with the Bosch EDC 15C-5.8 controller. In order to determine the values of vibration parameters of injectors working individually, measurements of vibration accelerations were already carried out on the all stages of the tests. The piezoelectric accelerometer was mounted on the hull of individual injectors in exactly the same place. The mounting location of the vibration sensor is shown in Figure 4. It should be emphasized that this measurement gives the possibility to register the injector's vibrations without any interference from other injectors working.

The injector test at the test bench is conducted in four stages. First, the injector overflow measurement was carried out at the maximum pressure in the power rail (for the tested type 140 MPa), then tests for maximum capacity (135 MPa) was carried out. The next stage was measurements for partial load (80 MPa). Finally, measurements for idling (25 MPa) and the measurements of the pilot dose was realized at the fuel pressure in the rail of 80 MPa. The test results for all injectors are summarized in Table 1. The table also shows the limit values for individual tests resulting from the information contained in the test bench software. Both measured and reference values are expressed in units mm^3/H , which is the volume of fuel calculated for one cycle of the injector operation. In

the case of tested injectors, the test lasted 30 s. The duration of the test and its parameters vary depending on the manufacturer and the type of injectors tested.

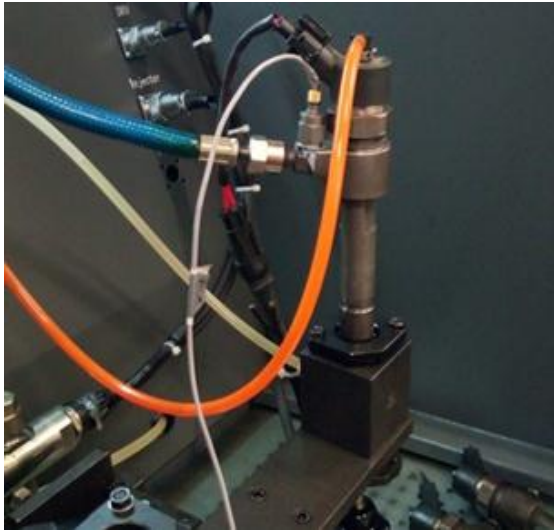

Fig. 4. The injector on the test bench with the marked location of the accelerometer

Table 1. Test results of individual injectors.

Injector number	1	2	3	4	5	6	7	8
Leak test, overflow: 35 mm ³ /H (+/- 35 mm ³ /H)	7,8	19,7	22,6	18,3	9,9	6,3	0,7	5,6
Full load, injected: 45,7 mm ³ /H (+/- 4,2 mm ³ /H)	12,7	16,2	16,9	20,5	45,8	43,0	45,1	44,4
Full load, overflow: 41 mm ³ /H (+/- 26,1 mm ³ /H)	27,5	50,1	44,4	46,6	35,3	25,4	24,7	26,1
Partial load, injected: 17,9 mm ³ /H (+/- 3 mm ³ /H)	6,7	8,9	8,1	10,3	15,6	14,3	12,4	13,5
Idle, injected: 2,8 mm ³ /H (+/- 2 mm ³ /H)	1,8	2,7	1,6	3,3	2,4	2,5	0,0	0,5
Pilot dose injected: 2,1 mm ³ /H (+/- 1,3 mm ³ /H)	1,2	2,2	1,9	2,5	3,1	1,0	0,0	1,2

In navy ship conditions, the crew is usually able to perform only the simplest overflow tests which, however, do not give full information about the technical condition of tested injectors, which is confirmed by the results presented in table 1. all injectors would meet the efficiency condition

specified by the overflow test. injectors 5 and 6 are characterized by optimal doses of injected and overflowed fuel with good leak test results. this proves their good technical condition (all values are within the middle range of values specified by the manufacturer) in contrast to other injectors, especially numbers 7 and 8, which should be considered as in the worst condition (not suitable for further use) . knowing the technical condition of the injectors, further tests were carried out to determine the relationship between the vibration parameters and the condition of the tested elements.

5. MEASUREMENTS OF VIBRATION PARAMETERS ON THE BENCH

The next stage of the research was to install the already tested two sets of injectors at the Common Rail diesel engine control unit station located at Polish Naval Academy. The stand was manufactured by Mechatronika company. The test station enables to control of the correct functioning of the CR system components with particular emphasis on the high pressure pump and injectors. The method of assembling the transmitters on the injector hulls is shown in Figure 5. Figure 6 shows the functional diagram of the station. The accelerometers was mounted at the same places as at the first stage of research. The accelerometers were mounted on threaded bases glued with epoxy adhesive glue.



Fig. 5. Four of tested injectors mounted on the test station together with vibration acceleration sensors (ACC1-ACC4)

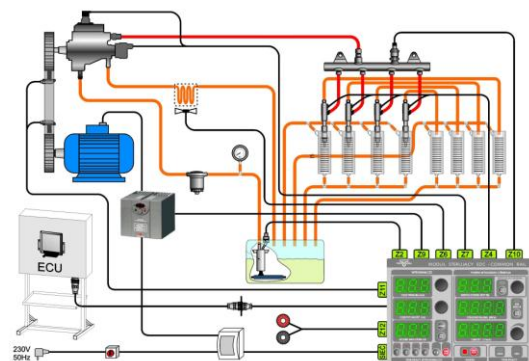

Fig. 6. Functional diagram of the Common Rail diesel engine control unit [22]

A characteristic feature of the station is the ability to control the operation of the injection system by an independent controller, thanks to which it is possible to change the injection

parameters and make them independent of the engine control map. However, for the needs of the measurements, the stand was controlled by a control computer dedicated to this type of engine. This enables the real character of the injectors operation to be reproduced. Recorded vibration signals excluding the forces associated with normal engine operation. The tests were carried out under operating conditions set for two rotational speeds (1500 rpm and 2000 rpm) and two different pressures in the Common Rail (50 and 80 MPa). During the measurements, the time courses of vibration accelerations in the band from 1 Hz to 12.8 kHz were recorded. Examples of vibration acceleration courses of all tested injectors operating at 80 MPa and 2000 rpm are presented in Figure 7. A sensors with guaranteed linearity for 10 kHz were used, therefore all analyzes were limited to this frequency.

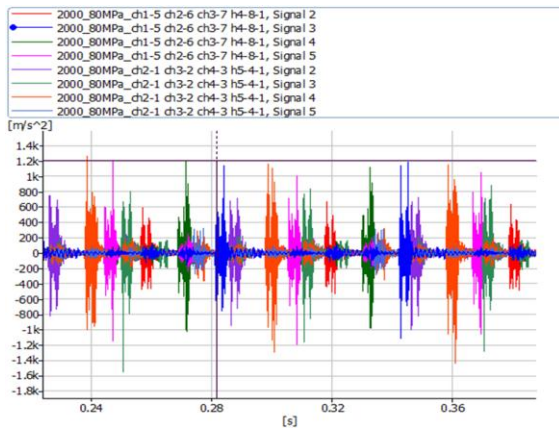

Fig. 7. Accelerations of vibrations comparison for all tested injectors working at CR pressure of 80 MPa and shaft rotational speed of 2,000 rpm

6. MEASUREMENTS AND RESULTS

Accelerations of vibrations time courses recorded during the measurements were analyzed using the Pulse Reflex software. First, the general values of vibration accelerations were compared from the entire recording time. Values were averaged over time periods of 50 ms. Figure 8 compares the values of the acceleration of vibration general level of all tested injectors. These are the results obtained during the test for partial load (test stand for injectors testing), so they refer to injectors working individually without the influence of other working in the injector engine. The bolded continuous lines indicate signals from the injectors, which technical condition was determined to be the best (no. 5 and 6).

The broadband analysis (5Hz-10kHz) makes it possible to state that injectors in good technical condition are characterized by values of the general level of acceleration at an average level. The deterioration of the technical condition results in the reduction or increase of the broadband value of vibration accelerations. Similar results were

obtained during all tests carried out in the first stage of testing (the exception was the leak test during which the injector does not work). During the next stage of analyzes, recorded signals were subjected to frequency analysis - Figure 9.

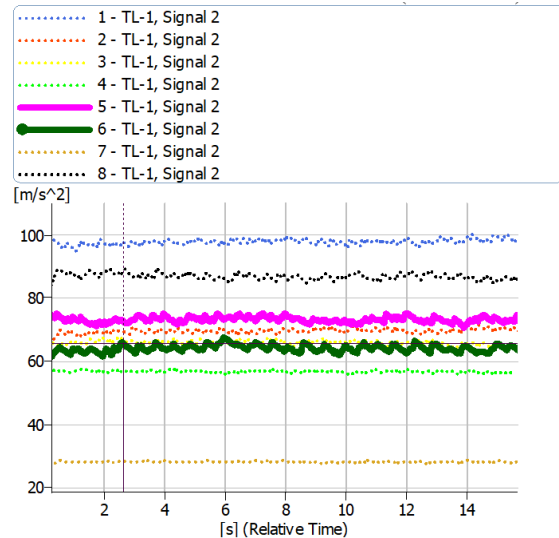

Fig. 8. General level of vibration accelerations in the range of 5 Hz-10 kHz of tested injectors during measurements at the test stand of the injectors under partial load (80 MPa)

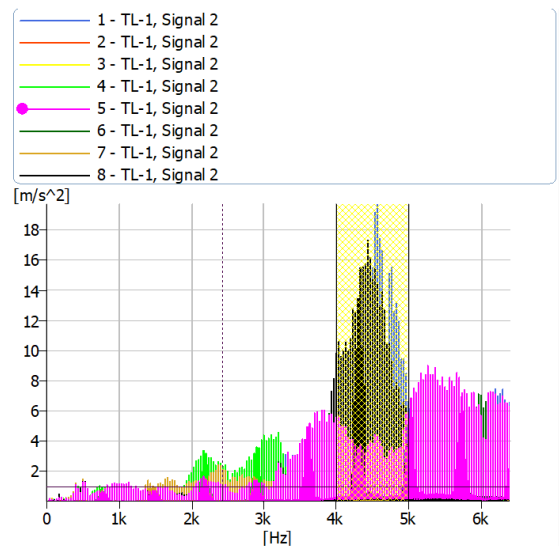

Fig. 9. Accelerations of vibrations amplitude spectra of all tested injectors during measurements at the injector test stand under partial load (80 MPa)

Analysis of the spectra presented on Figure 9 allowed to determine the range of potentially sensitive frequencies (4-5kHz) for changes in the technical condition of the type of injectors under consideration. Table 1 presents the average values of vibration accelerations calculated for the frequency range indicated in Figure 9.

Table 2. Average values of vibration accelerations in the range of 4-5kHz

Injector number	1	2	3	4	5	6	7	8
a_{rms} (4-5kHz) [m/s ²]	66,50	48,56	48,68	39,47	25,42	36,18	17,63	69,26

The occurrence of the same dependencies as in the case of analysis of the general vibration level in the range of 10Hz-10kHz was found. The deterioration of the technical condition of injectors caused a change in the value of vibration accelerations below or above the range of characteristic values for efficient injectors. It is characteristic that the initial stages of damage occurring in the case of injectors 1-4 (see table 1) causing an increase in the value of vibration accelerations in the indicated frequency band. Injectors operating with significant damage 8-9 (see table 1) are characterized by decreasing these values in relation to the optimal values characteristic of fully functional injectors.

The same method of signal analysis was used in the case of signals registered during the operation of injectors at the Common Rail engine control station (Fig. 5). The values of the general level of vibration acceleration of all tested injectors are shown in Figure 10.

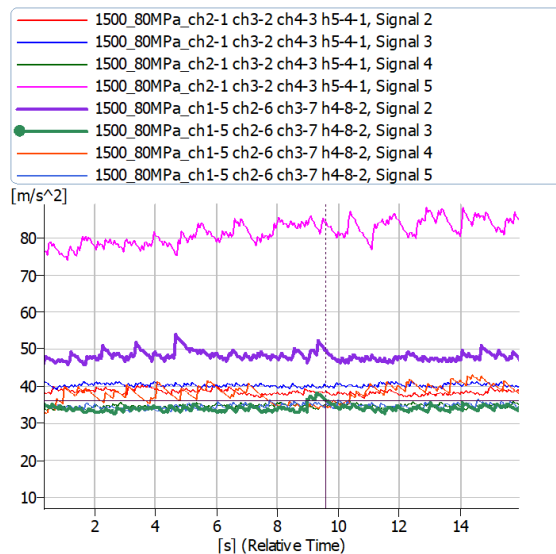

Fig. 10. Accelerations of Vibrations general level in the range 5 Hz-10 kHz for tested injectors during measurements at the common rail engine control station stand

Interpretation of the results presented in Figure 10 does not allow to state similar conclusions as for first stage of measurements. The reason for this fact is probably the impact of vibrations generated by the remaining working injectors. Therefore, the analysis of frequency spectrums was made, resulting in the selection of a frequency region potentially sensitive to changes in the technical condition in the range of 500-2000 Hz - Figure 11. This region is different than in the case of analyzes carried out in relation to signals from the first stage

of research. This is due to the fact that the way the injectors are mounted on test bench is completely different.

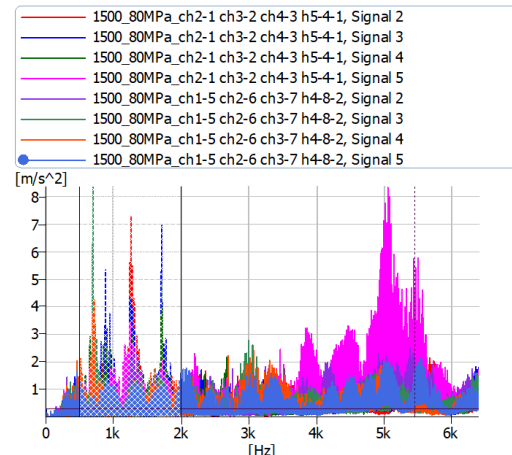

Fig. 11. Vibrations of acceleration amplitude spectra of all tested injectors during measurements at the common rail engine control station for a rotational speed of 1500 rpm and CR pressure of 80 MPa.

The values of the mean value of vibration accelerations for the selected 500-2000Hz frequency range are shown in Table 3.

Table 2. Average values of vibration accelerations in the range of 500-2000Hz.

Injector number	a_{rms} (500-2000Hz)			
	Load rpm_MPa			
	1500_50	1500_80	2000_50	2000_80
1	13,58	24,26	22,17	20,93
2	15,38	26,11	22,16	25,62
3	15,09	20,18	18,84	20,70
4	16,32	19,96	16,60	19,65
5	12,56	16,99	15,03	19,01
6	14,24	17,36	15,78	23,79
7	11,43	14,14	12,76	20,58
8	10,99	10,96	9,74	17,88

The obtained average values of vibration accelerations in the frequency range 500-2000 Hz of efficient injectors assume to have nominal values, especially for partial loads. It is necessary to select a frequency range sensitive to each type of injectors due to the fact that the values of vibration parameters from the individual injectors working under nominal operating conditions are imposing. Therefore, the obtained values of general vibration levels can be misleading.

7. CONCLUSIONS AND FURTHER RESEARCH

The analysis of the obtained results allows to indicate certain dependencies between the technical condition of Common Rail injectors defined at the measurement stands and their vibration parameters. It is possible to specify the frequency range in which changes in the value of vibration

accelerations identify changes in the technical condition of the injectors. This frequency range is characteristic for a given type of injectors, depending also on the method of its mounting on the engine. Therefore, it is necessary to perform the reference characteristics of vibration accelerations of efficient injectors in the full range of engine loads. By referring current values of vibration parameters to known reference values, it is possible to determine if a given injector is suitable for normal operation. It has been found that the state of technical inefficiency of injectors causes their vibroactivity to increase. Damaged injectors are characterized by vibration parameters lower than those specified for fully functional injectors.

The obtained results are a good premise for further research, which the authors will take in relation to the tested injectors working on the engine. It will allow to obtain signals disturbed by vibrations generated by engine auxiliary mechanisms. It will also be important to change the way how injectors are mounted on the engine. This will probably change the range of sensitive frequencies.

In order to implement the method of determining the technical condition of Common Rail injectors on board of Polish Navy ships, it is still necessary to carry out many tests on CR engines of various types with injectors. It will be necessary to determine the values of vibration parameters characteristic of fully efficient injectors. On this basis, it will be possible to precisely determine the value of changes in vibration symptoms that give information on the technical condition of injectors of naval diesel engines operating in the Common Rail fuel systems.

REFERENCES

- Arroyo J, Muñoz M, Moreno F, Bernal N, Monné C. Diagnostic method based on the analysis of the vibration and acoustic emission energy for emergency diesel generators in nuclear plants. *Applied Acoustics*. 2013;74,(4): 502-508. <https://doi.org/10.1016/j.apacoust.2012.09.010>
- Carlucci AP, Chiara FF, Laforgia D. Analysis of the relation between injection parameter variation and block vibration of an internal combustion diesel engine. *Journal of Sound and Vibration*. 2006; 295: 141-164.
- Chiatti G, Chiavola O, Recco E, Magno A, Vaglieco BM. Accelerometer measurement for MFB evaluation in multi-cylinder diesel engine. *Energy* 2017; 133:843-850. <https://doi.org/10.1016/j.energy.2017.04.148>
- Delvecchio S, Bonfiglio P, Pompoli F. Vibro-acoustic condition monitoring of Internal Combustion Engines: A critical review of existing techniques *Mechanical Systems and Signal Processing*. 2018; 99: 661-683. <https://doi.org/10.1016/j.ymssp.2017.06.033>
- Dykas B, Harris J. Acoustic emission characteristics of a single cylinder diesel generator at various loads and with a failing injector. *Mechanical Systems and Signal Processing*. 2017;1:397-414 <https://doi.org/10.1016/j.ymssp.2017.01.049>
- Jafarian K, Mobin M, Jafari-Marandi R, Rabiei E. Misfire and valve clearance faults detection in the combustion engines based on a multi-sensor vibration signal monitoring. *Measurement*. 2018; 128:527-536. <https://doi.org/10.1016/j.measurement.2018.04.062>
- Jianmin L, Yupeng, Xiaoming Z, Shiyon X, Lijun D. Fuel Injection System Fault Diagnosis Based on Cylinder Head Vibration Signal. 2011. *Procedia Engineering*. 2011;16:218-223. <https://doi.org/10.1016/j.proeng.2011.08.1075>
- Kluczyk M, Grządziela A. Vibration diagnostics of common rail injectors, *Journal of Marine Engineering & Technology*, 2016;16(4):177-184.
- Konieczny Ł, Adamczyk B, Adamczyk G. Diagnostyka i regeneracja wtryskiwaczy CR. *Scientific Journal of Silesian University of Technology. Series Transport*. 2015;86:65-73. Polish. <https://doi.org/10.1080/20464177.2017.1387088>
- Mancaruso E, Sequino L, Vaglieco BM. Analysis of the pilot injection running Common Rail strategies in a research diesel engine by means of infrared diagnostics and 1d model. *Fuel*, 2016;178:188-201. <https://doi.org/10.1016/j.fuel.2016.03.066>
- Marčič S, Marčič M, Praunseis Z. Mathematical Model for the Injector of a Common Rail Fuel-Injection System. *Engineering*. 2015;7:307-321.
- Puchalski A. A technique for the vibration signal analysis in vehicle diagnostics. *Mechanical Systems and Signal Processing* 2015;56-57:173-180. <https://doi.org/10.1016/j.ymssp.2014.11.007>
- Siano D, Panza MA. Diagnostic method by using vibration analysis for pump fault detection. *Energy Procedia*, 2018;148:10-17. <https://doi.org/10.1016/j.egypro.2018.08.013>
- Stoek T, Osipowicz T. Usterki mechaniczne wtryskiwaczy układów Common Rail. *Buses*. 2015;6: 214-217. Polish.
- Szymański GM, Tomaszewski F. Diagnostics of automatic compensators of valve clearance in combustion engine with the use of vibration signal. *Mechanical Systems and Signal Processing*. 2016; 68-69:479-490. <https://doi.org/10.1016/j.ymssp.2015.07.015>
- Taghizadeh-Alisarai A, Mahdavian A. Fault detection of injectors in diesel engines using vibration time-frequency analysis. *Applied Acoustics*. 2019; 143: 48-58. <https://doi.org/10.1016/j.apacoust.2018.09.002>
- Śmieja M, Wierzbicki S, Mamala J. Sterowanie dawką wtryskiwanego paliwa w układzie Common Rail z wykorzystaniem środowiska LabView. *Combustion engines*. 2013;154(3):542-548.
- Wierzbicki S, Śmieja M, Grzeszczyk R. Zintegrowane sterowanie stanowiskiem badawczym silników o ZS w środowisku fast prototyping. *Combustion engines*. 2013;154(3): 536-541.
- Wierzbicki S, Śmieja M. Visualization of the parameters and changes of signals controlling the operation of Common Rail injectors. *Solid State Phenomena*. 2014;210:136-141. <https://doi.org/10.4028/www.scientific.net/SSP.210.136>
- Wierzbicki S. Effect of the proportion of natural gas in the feeding dose on the combustion process in a self-ignition engine with a Common Rail fuel system. *Diagnostyka*. 2018;19(4):65-70. <https://doi.org/10.29354/diag/99534>

21. www.mechatronika.pl – instrukcja zespołu sterowania silnikiem ZS typu Common Rail.
22. www.bosch.com
23. www.mtu-report.com
24. Qiang W, Peilin Z, Chen M, Huaiguang W, Cheng W. Multi-task Bayesian compressive sensing for vibration signals in diesel engine health monitoring. *Measurement* 2019;136:625-635.
<https://doi.org/10.1016/j.measurement.2018.07.074>

Received 2019-02-17

Accepted 2019-06-03

Available online 2019-06-04



Ph.D. Eng. Lt. **Marcin**

KLUCZYK is an Assistant in the Faculty of Mechanical Electrical Engineering at the Polish Naval Academy. He had been chief mechanic on board of minesweeper for four years. Since 9 years he has working in Polish Naval Academy conducting classes in various subjects mainly in marine

power plants, theory of vibrations, diagnostics of marine equipment and some other subjects. He is focused especially on vibroacoustic diagnostic of marine diesel engines and marine auxiliaries.



Ph.D Eng. **Andrzej**

GRZADZIELA., Assoc. Prof. Cpt (R), is a Professor in the Faculty of Mechanical Electrical Engineering and former Dean of this Faculty. He served on Tarantula class corvettes as a Chief Engineer six years. Over 20 years he has working in Polish Naval Academy in Gdynia, from last

five years as a professor. His teaching areas are Naval Engineering and Machine Dynamics. He has published articles on vibroacoustics, marine propulsion dynamics and diagnostics of gas turbines.