

Received April 27, 2018; reviewed; accepted November 28, 2018

Coupling mineralogy with physicochemical parameters in view copper flotation efficiency improvement

Dejan Naumov ¹, Lachezar Stamenov ², Stoyan Gaydardzhiev ¹, Hassan Bouzahzah ¹

¹ University of Liege, GeMMe, Allée de la Découverte 9, Sart-Tilman B52/3, 4000 Liege, Belgium

² Dundee Precious Metals Chelopech EAD, Village of Chelopech 2087, Bulgaria

Corresponding author: s.gaydardzhiev@uliege.be (S. Gaydardzhiev)

Abstract: The Chelopech epithermal arsenic bearing high-sulphidation, copper-gold deposit located in Bulgaria is often considered as the richest European gold deposit. Selected physicochemical parameters have been measured at key flotation streams inside the processing plant. Sampling campaign has followed with samples being submitted to chemical and mineral liberation analyses. A quantitative analysis has enabled to link copper flotation response to the type of copper bearing minerals and physiochemical parameters such as redox potential (E_h), dissolved oxygen (DO), EDTA extractable Cu and Fe. Data from the mineral liberation analysis (MLA) have highlighted an important process-relevant information explaining the variable floatability in different particle size ranges. A low chalcopyrite recovery can be linked to the non-sufficient amount of dissolved oxygen inside the copper selective flotation. Given the finely-disseminated copper bearing minerals, copper losses due to particle locking could be suggested as well.

Keywords: copper ore, flotation, quantitative mineralogy, physico-chemical factors

1. Introduction

1.1. Geology

The Chelopech mine located in Bulgaria is a part of the Dundee Precious Metals (DPM) group from Canada. The underground mine and the associated flotation plant produce copper and pyrite concentrates. The Chelopech deposit itself is a high sulphidation (HS) volcanic-hosted epithermal gold-copper one (Bonev et al., 2002; Strashimirovet al., 2002; Kouzmanov et al, 2009;). It is considered as one of the largest and economically most important ore deposits in Bulgaria and often is referred to Europe's largest currently mined gold resource. It is located in the Srednogorie zone, which falls within the central sector of the extensive Tethyan–Eurasian copper belt formed during Mesozoic–Cenozoic time along the southern margin of Eurasia. The Srednogorie zone has the features of a subduction-related, Late Cretaceous island arc, with development of a calc-alkaline to sub-alkaline volcano-plutonic magmatism and associated hydrothermal ore deposits (Bonev et al., 2002).

Gold copper mineralisation occurs as veins, mineralised breccia, and massive sulphide replacements and disseminations. Three mineralisation stages have been identified at the Chelopech deposit. An early pyrite–marcasite mineralisation (stage I), characterised by disseminated to massive pyrite followed and partly brecciated by enargite–luzonite and tennantite–chalcopyrite–bornite (stage II) mineralisation. Gold is met in ores belonging to the stage II. Sphalerite and galena veins characterise stage III, best developed below and adjacent to the pyrite–enargite–chalcopyrite ore bodies. Advanced argillic altered volcanoclastic rocks commonly host this mineralisation (Chambefort and Moritz, 2014).

1.2 Mineralogy

The mineralogy of the Chelopech deposit is dominated by pyrite, likewise marcasite, melnikovite etc., which form on average some 20% of the orebodies by volume. The principal ore minerals comprise

chalcopyrite, tennantite, enargite and luzonite together with subordinate famatinite, sphalerite and galena. Quartz, barite and kaolinite are the dominant gangue minerals with chlorite, ankerite and gypsum subordinate. It should be noted, that the mineralogy is very complex and to date some 71 mineral species have been identified (Bonev et al., 2002).

In their order of abundance, the main economic copper bearing minerals are: chalcopyrite, tennantite, enargite, tetrahedrite, luzonite, bornite and famatinite. In overall about 65% of the copper is in the form of arsenides and sulphosalts, and about 35% appears as chalcopyrite.

1.3. Ore processing

The Chelopech flotation circuit entails several stages, the first one is a bulk sulphide stage realised in four 100 m³ Outokumpu tank cells. pH is kept around 8.5, and a bulk sulphide concentrate containing all copper bearing minerals and majority of pyrite is collected and forwarded to a cleaner circuit.

The combined concentrate flows to a conditioning tank, where lime is added for pyrite depression at pH 12. After the conditioner, the concentrate is transported to four Denver-500-4 cells, which constitute Cu-rougher flotation. The rougher section produces an intermediate concentrate, which is sent to the first copper-cleaner realised by SFR's (Staged Flotation Reactors), producing the final copper-gold concentrate that is dewatered, filtered and stocked for shipment. The tailing from the rougher section is fed into four D300-4 cells to form the Cu-selective scavenger flotation. The concentrate from this section is recycled back to the Cu-rougher section, while tailings are directed towards pyrite flotation. The flowsheet used at the copper recovery stage is pictured in Fig. 1. For illustration simplicity, the product marked as n° 24 (Cu- selective scavenger tailing) is joined with the bulk tail instead be delivered to pyrite recovery section.

The pyrite recovery circuit (not discussed in this study) consists of a two cleaning stages, involving 5 and 3 SFRs respectively. It delivers the pyrite concentrate enriched in gold, which is subsequently dewatered and stocked for shipment, and the final tailing being disposed.

The reagents currently used are potassium amyl xanthate (PAX) as a collector, Oreprep F549 as a frother and slaked lime for pH control.

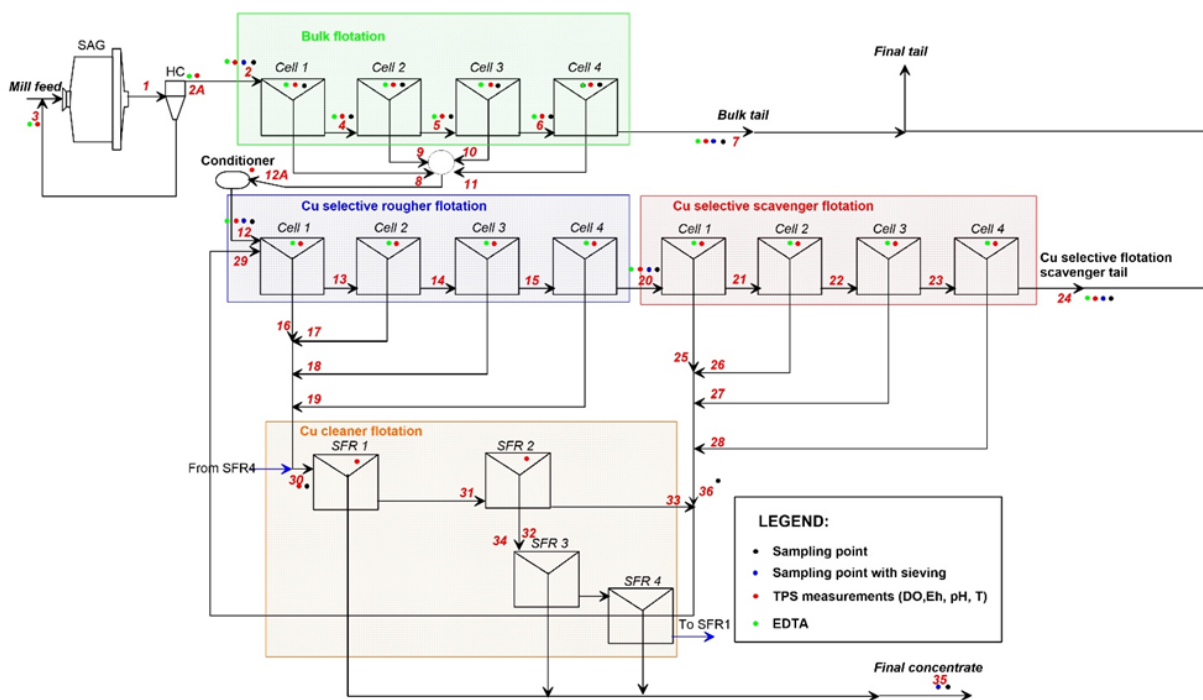

Fig. 1. Copper flotation circuit with sampling and measuring points

The objective of the present study was to investigate the operational conditions at both bulk sulphide and copper selective circuits and to diagnose their metallurgical performances in line with the measured

physicochemical parameters. In parallel, a mineralogical analysis on selected samples taken during plant survey was aimed to find a clue about the reasons for possible metallurgical losses.

2. Materials and methods

2.1. Processing plant survey

Plant survey of bulk and copper selective flotation circuits was realised by collecting representative samples from purposely determined points. The obtained samples were subsequently split for chemical assays and mineralogical examination.

In order to assess the electrochemical and physicochemical conditions in a quantitative manner, selected points of the circuit were monitored using a TPS device (model TPS 90 FLMV data logger) with recording redox potential (E_h), pH, dissolved oxygen (DO) and temperature. Sampling was conducted during 135 minutes with 15 min interval. Material was transferred in buckets and dried in an oven at around 105 °C.

Moreover, Cu and Fe EDTA extractable ions were measured in pulp samples taken at bulk and copper selective stages. These samples were collected at the end of the sampling campaign in 1 dm³ plastic bottles and placed in a fridge to minimize chemical reactions and oxidation of copper and iron species. Fig. 1 depicts the location of the sampling points within the circuit.

2.2. E_h , pH and dissolved oxygen (DO) recording

The TPS instrument records E_h , pH, DO and temperature values automatically. During the current campaign, the instrument was set to sample every 5 seconds in a 2-minute interval in accordance to the established procedures. The DO concentration follows the exponential line and collected data are fitted according to the equation:

$$DO = DO_0 e^{-Kla \cdot t} \quad (1)$$

where DO is the dissolved oxygen at time t , DO_0 is DO at time zero, t is time and Kla is oxygen demand constant (also called DOD).

2.3. EDTA extraction

EDTA extraction was used to determine the amount of oxidation species in the pulp. A 3 wt% EDTA solution, based on ethylene diamine-tetra acetic acid disodium, was always freshly prepared. The pH was adjusted to 7.5 by adding the sodium hydroxide solution. Further, 250 cm³ of the EDTA solution was placed in a vigorously-stirred reaction vessel and continuously purged with nitrogen for 10 minutes to eliminate oxygen. Then, 25 cm³ of the slurry sample was introduced to the EDTA solution and agitated with EDTA for 10 min., while nitrogen was continuously purged throughout. The slurry was then filtered through a 0.45 µm Millipore filter. Atomic adsorption spectroscopy (AAS-ContrAAA Zeiss) was used to quantify Cu and Fe ions in the solution.

2.4. Chemical and mineralogical analysis

The collected samples from the flotation plant survey were divided with a riffle splitter to suitable masses between 1.5 - 3.0 grams. The copper-selective scavenger tailings were sieved in five size fractions: - 20, + 20 - 45, + 45 - 90, + 90 - 180 and + 180 µm. The chemical analyses of Cu, S and As were done using an ICP-AES after the indispensable digestion procedure.

An Olympus BX60 optical microscope under reflected light was used for observations. The microscope is equipped with a digital camera, which allows recording images. The system was fitted with four objectives, providing magnifications: 5x, 10x, 20x and 50x.

Samples for the mineral liberation analysis (MLA) were prepared as 30 mm polished epoxy blocks. After cleaning with ethanol and ultrasound and coating with 4 nm graphite under vacuum, the polished samples were investigated by a SEM Quanta 650 FEG from FEI Company, equipped with a Bruker EDX spectrometer. Data processing and visualization were realized by the MLA2.9 Software (JKTech).

Automated sessions with the XBSE- and XBSE-STD method were performed at an image magnification of 175x. Enargite and tennantite were not distinguished separately since their chemical

composition is quite similar, with the only exception being the amount of Fe present in the tennantite (<4 %), which is however difficult to be used as a discriminator.

The copper minerals as given by their wt% in the bulk sample and each size fraction were summed up to present modal mineralogy where the proportion of each copper mineral was respectively calculated. The elemental distribution of copper that presents the copper losses in each mineral was calculated multiplying the wt% of each mineral with its stoichiometric copper amount.

The particles measured in the samples were sorted by decreasing area and this data further processed and optimised for detailed inspection of individual grains using the MLView software.

3. Results and discussion

3.1. Physicochemical observations

Fig. 2 shows the redox potential (E_h), measured at the various surveyed points together with the Kla constant representing the dissolved oxygen removal rate per minute (also called here DOD). The low E_h and high DOD immediately after the grinding stage could be explained by emerging of fresh pyrite surfaces and by generation of iron hydroxides released from the grinding media. Although the grinding circuit uses semi-autogenous milling, the latter effects take place. The rapid depletion of oxygen in the pulp can be spotted in the HCOF and HCUF points, likewise in the flotation feed stream. It is reported that pyrite could generate H_2O_2 on its surface during grinding (Javadi, 2013), thus contributing to the low oxygen level being measured. High values of DOD (Kla) could be also observed following pH increase through lime addition in the pulp. Inside the flotation cells, the oxygen that enters with air bubbles seems to be sufficient for maintaining the oxidising environment. The redox potential (E_h) for streams 12A and 12 showed negative values below -100 mV and under these conditions one could assume that pyrite surfaces consumed virtually the entire amount of dissolved oxygen. From the other side, it should be noted that after conditioning, stream 12 had the highest oxygen demand suggesting the need for prolonged conditioning of the pulp in order to guarantee satisfactory pyrite depression. Although there are still some debates on pyrite depression mechanisms, it is generally agreed that formation of a mixed films of $Fe(OH)_3$, $FeO(OH)$, $CaSO_4$ or $CaSO_3$ on pyrite surfaces takes place, which prevents collector adsorption (Bulatovic, 2007; Chen et al., 2014).

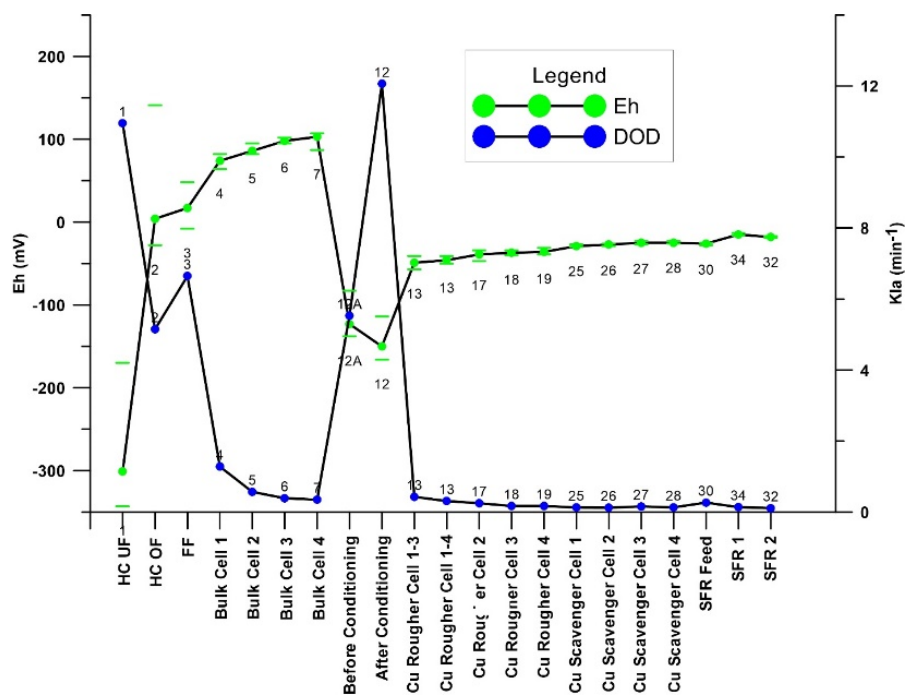

Fig. 2. Variation of E_h and Kla (DOD) at the investigated points

The data of E_h and pH as measured at the bulk flotation section are depicted in Fig. 3. One could see, that both parameters increase starting from hydrocyclone overflow and going further towards the

flotation feed. Dashed lines represent the deviation of the measured values. The wide range of E_h recorded is witnessing the high chemical reactivity of the pulp. Pulp conditions tend to be more stable inside bulk flotation cells with E_h values slowly increasing due to oxidation conditions. The same oxidation conditions are responsible for the decreased pH in the bulk flotation cells. After the bulk flotation stage, pH increases to 12 and brings pyrite surface charge to shift from positive to negative.

Fig. 4 shows the concentration of EDTA extractable iron and copper ions in the measured points within the flotation circuit. As a rule, EDTA has the ability to selectively dissolve oxidised metals, but not the sulphide minerals themselves (Rumbal et al., 1996). Elevated concentration of EDTA extractable iron in the hydrocyclone overflow is notable, which is logical considering the preceding grinding stage. The extractable copper ions have lower concentrations in the pulp from bulk flotation stage than those inside the selective copper flotation. Increasing pH generates copper and iron oxides and hydroxides on the mineral surfaces. The results shown in Fig. 4 imply a significant presence of copper ions, a situation being also encountered by Chen et al. (2013), when investigating the role of copper ions on pyrite flotation.

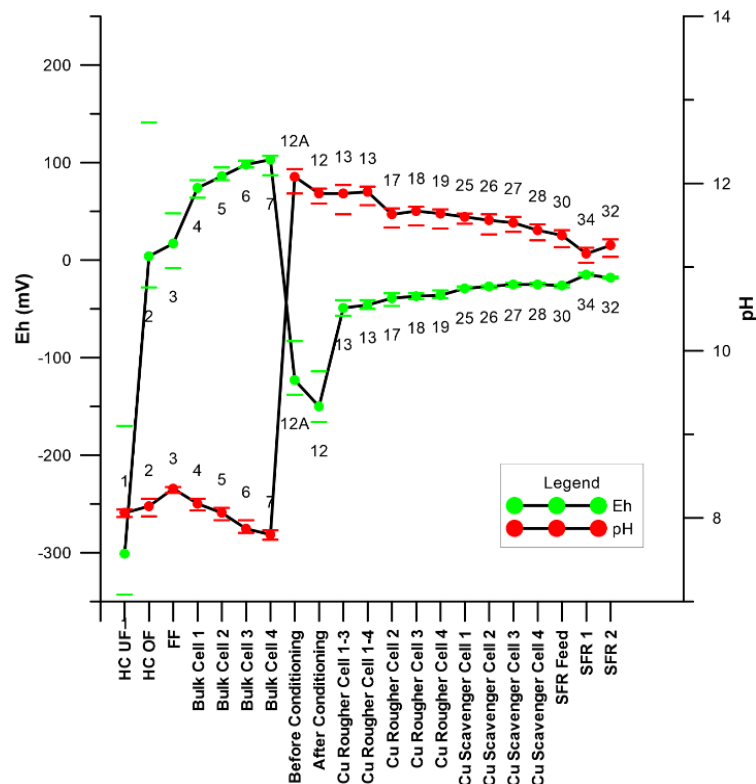

Fig. 3. Eh and pH registered at the plant survey sampling points

3.2. Mineralogical peculiarities

As indicated by the MLA findings (Fig. 5), the mineral composition of the tailings from Cu-selective scavenger undoubtedly ranks pyrite as the most abundant mineral with quartz, kaolinite, muscovite and oxides of titanium and iron (below 1%) as the major gangue minerals. The remaining gangue minerals altogether account to less than 1%. The principal copper mineral coming across is chalcopyrite, followed by enargite/tennantite and minor portions of bornite and covellite.

The mineral association of copper bearing for different size fractions (Fig. 6) more or less corroborates with the results of modal mineralogy, with quartz and pyrite being the main gangue minerals associated with copper bearing minerals. The rest gangue minerals united under "gangue", does not correlate closely with the copper minerals losses. The quartz abundance is not significant in $-90 \mu\text{m}$ fractions. Bornite is not associated with quartz in the tailings. The free surface shows unsuitable conditions for chalcopyrite flotation. Indeed, while copper shows the most liberated surface, the observed recovery is relatively low. The copper minerals are interlocked mostly with the pyrite, which is not surprising having in mind that the bulk sulphide flotation is supposed to reject the non-sulphide gangue.

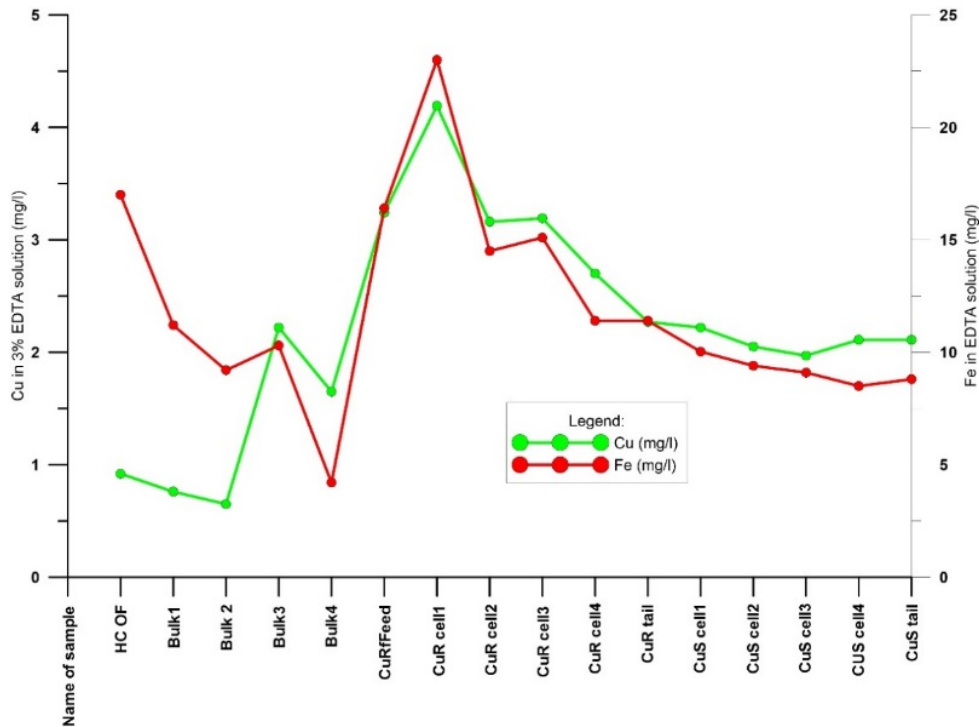

Fig. 4. EDTA extractable Cu and Fe at the various plant survey points

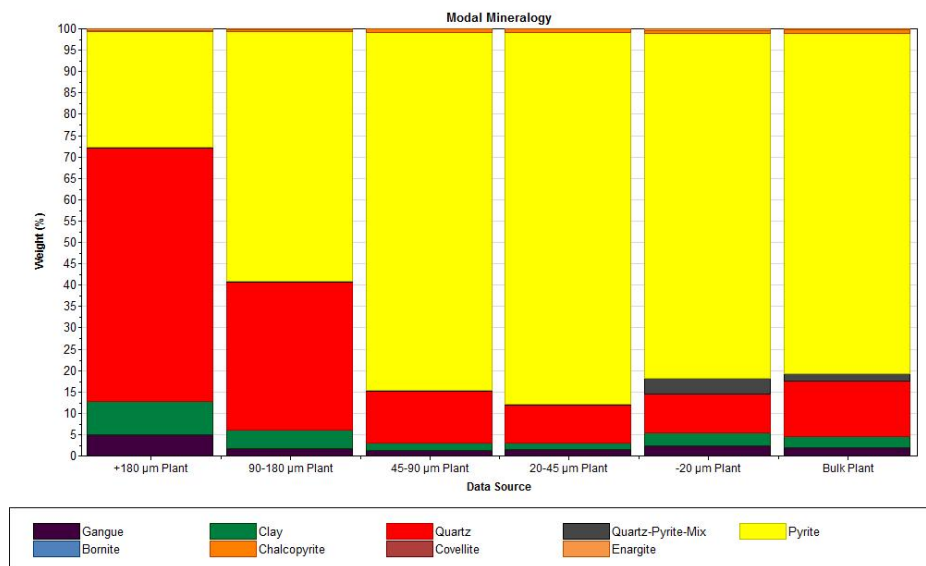

Fig. 5. Mineral composition (% by weight) of scavenger tailings from copper selective circuit (granulometric fractions and bulk material)

Micrographs from the 45-90 μm fraction of the copper-selective scavenger feed and tailings are presented in Fig. 7. In Fig. 7 (left), one could distinguish ore minerals having different textures entering this the flotation stage. The feed contains minerals being either entirely liberated or simple locked, accompanied by finely disseminated copper bearing minerals. The tailings, apart from their high amount of pyrite containing micro-inclusions of copper, appear to carry as well locked covellite and tenantite as well (Fig. 7 right).

The MLA per size fractions and the respective copper losses associated with the principal copper bearing minerals are presented in Table 1. It could be noted, that the main copper minerals contribute to a different extent towards flotation losses. The results clearly indicate that the principal copper losses are linked to chalcopyrite (69%) and enargite/tennantite (28%). It is expected since those are the two main copper minerals. However, an average 35% of the copper, which is related to the chalcopyrite, fits well

to 31% copper losses in the +180 μm fraction. A perusal of the data also suggests how decreasing chalcopyrite grain size corroborates with increase in Cu losses, in contrast to the rest copper bearing minerals (i.e. enargite) which are well liberated and float well.

The chalcopyrite mineral liberation by the particle composition in different size fractions of the tailings is given in Fig. 8. The results indicate that chalcopyrite present in the +180 μm size fraction is 10% liberated, while its liberation degree in the 90-180 μm size fraction is around 50%. The size fraction below 20 μm contains less liberated chalcopyrite than 20-45 and 45-90 μm size fractions. This fact most likely provoked better flotation of chalcopyrite in the -20 μm size fraction (only 58% being lost, Table 1). The mean liberation of the chalcopyrite for the composite sample is 70%. The results imply that the chalcopyrite recovery in the copper scavenger circuit is not influenced by chalcopyrite locked with the gangue. Since the liberation degree of the chalcopyrite seems quite acceptable, the reasons for its low recovery could therefore lie either in pulp physicochemical conditions or in unsuitable reagent suite or could be due to its notorious low flotation kinetics.

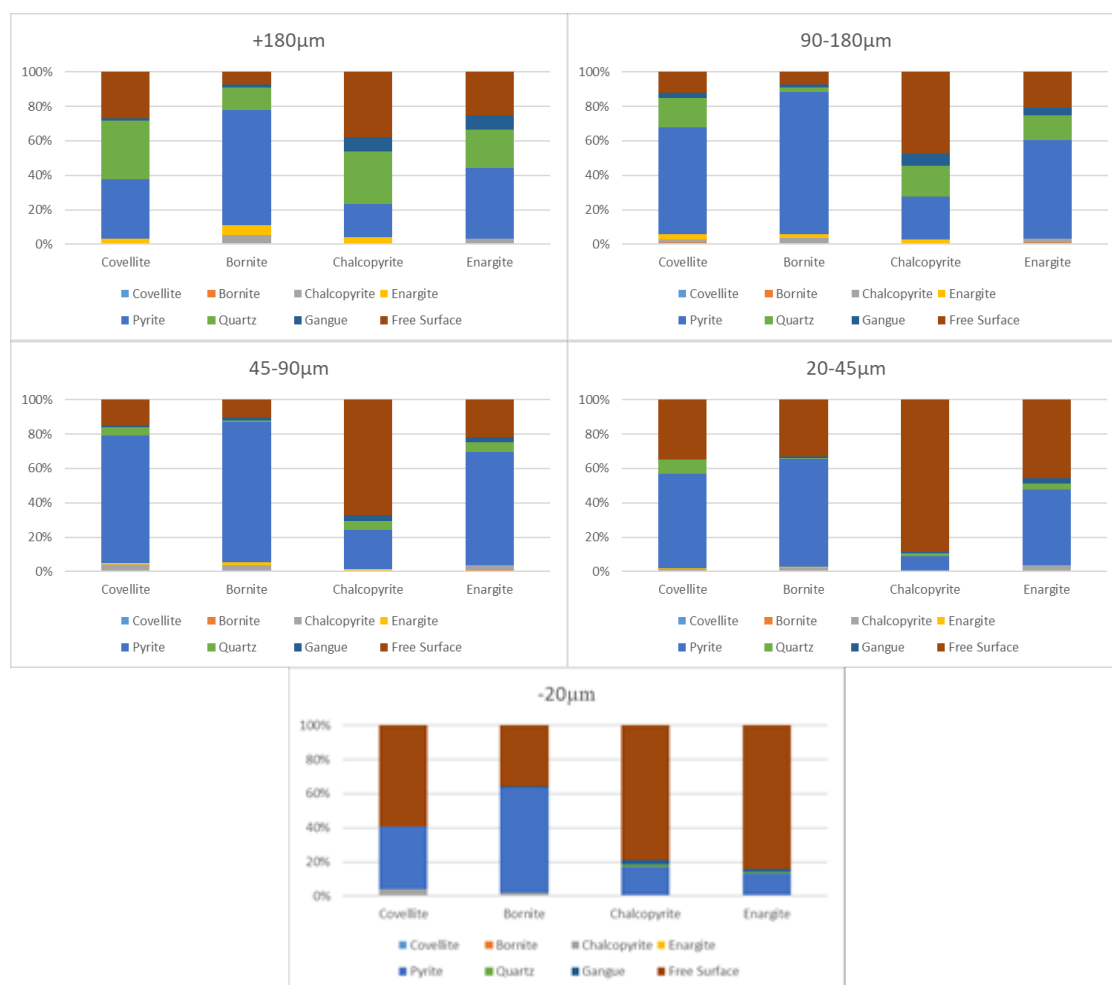

Fig. 6. Copper mineral association in the tested size fractions

Table 1. Modal mineralogy and copper losses elemental distribution

Mineral/ size fraction (μm)	Mineral, wt%						Copper losses elemental distribution, %					
	+180	90-180	45-90	20-45	-20	Bulk	+180	90-180	45-90	20-45	-20	Bulk
Bornite	3	4	3	2	0	2	4	7	5	3	0	3
Chalcopyrite	40	73	85	93	66	76	31	65	79	90	58	69
Covellite	2	1	1	0	0	0	3	2	2	0	0	0
Enargite	56	21	11	5	34	22	61	26	14	7	42	28

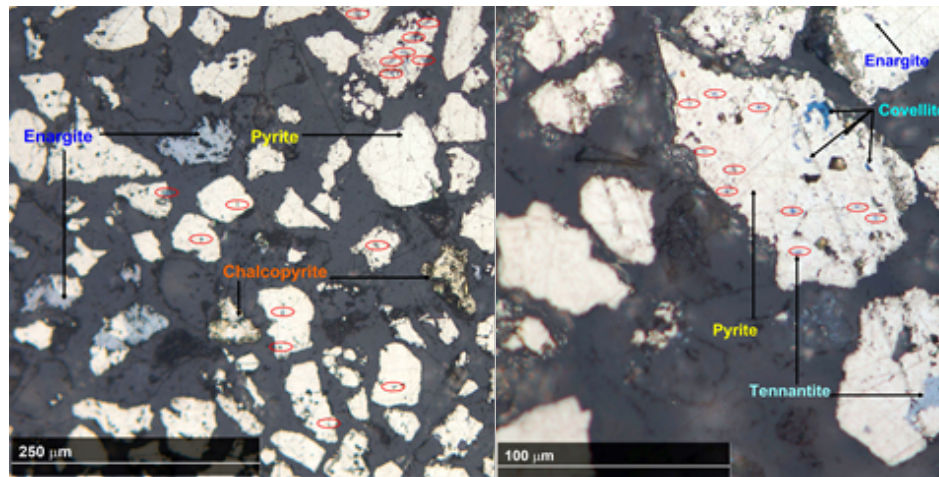

Fig. 7. Optical view of 45-90 μm Cu-selective scavenger feed (left) and scavenger tailings (right) (micro inclusions)

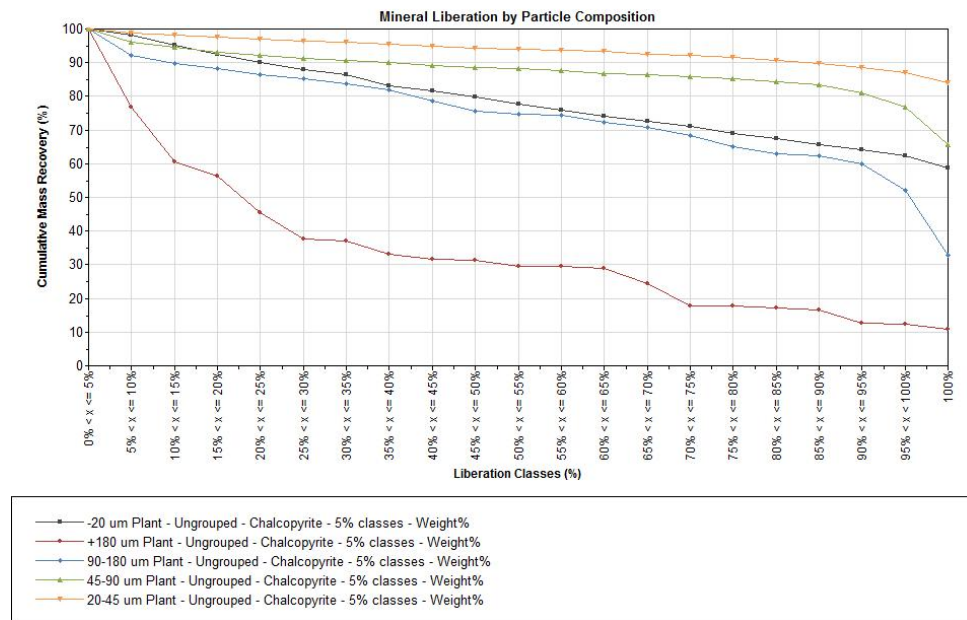

Fig. 8. Chalcopyrite mineral liberation by particle composition

Enargite/tennantite mineral liberation by particle composition for different size fractions is given in Fig. 9. The principal observation, is that enargite and tennantite are poorly liberated in the size fractions coarser than 45 μm , while the finer size fractions tend to be liberated to approximately 50%.

Although covellite and bornite are found traces in the ore, thus barely contributing to 5% of the total copper, their liberation by particle composition has been performed but not shown here. Both minerals were detected as not entirely liberated in the copper-selective scavenger tailings. They were nevertheless well floating, hence could not contribute to major copper losses, but rather could be suspected as a principal source of copper ions in the pulp.

The MLA images of feed particles sorted by decreasing area are summarized in Fig. 10. Chalcopyrite was in majority found as liberated and as simple locking, mainly associated with pyrite (Fig. 10A). Locked particles were found as micro inclusions generally in pyrite, with copper minerals and galena sized in the range of few microns (Fig. 10B and 10C). Again, copper losses could be predominately due to locking resulting from fine disseminated copper bearing minerals. These locked mineral assemblages are unrecoverable by conventional flotation. A complex texture can be noted for the gangue minerals, quartz and pyrite (Fig. 10D).

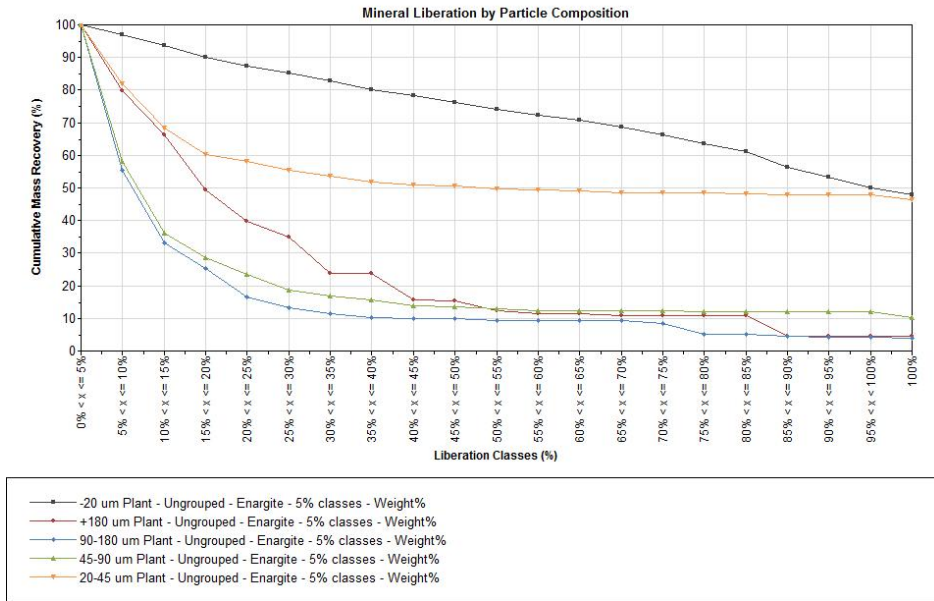

Fig. 9. Enargite/tennantite mineral liberation by particle composition

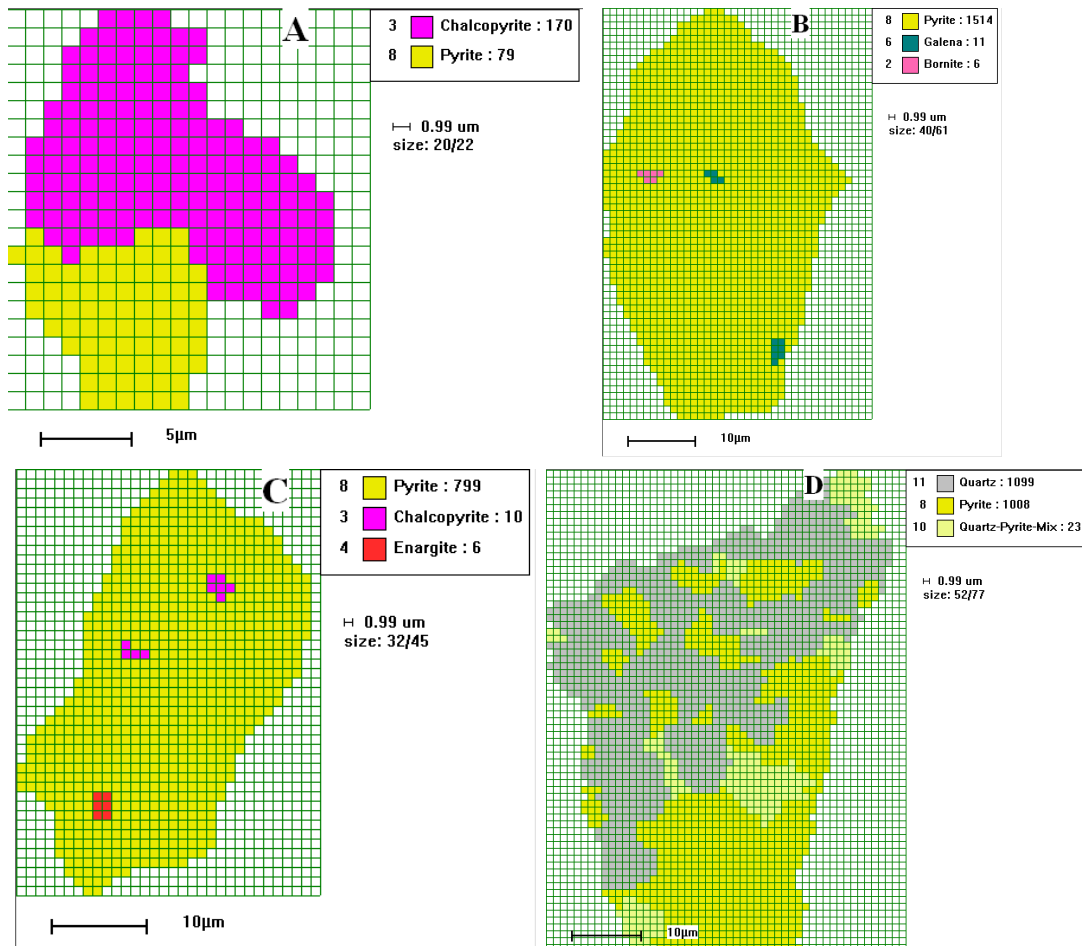

Fig. 10. Particle images as given by the MLA

4. Conclusions

The presented results demonstrate the importance of understanding how ore mineralogy could influence flotation results. Maintaining proper aeration conditions within the entire flotation circuit has to be a priority. The lack of DO in the conditioner outflow was provoked most probably by the rapid oxygen consumption through fresh pyrite surfaces generation. This situation justifies the use of the first flotation cell bank for conditioning only.

Copper losses in the copper selective stage were either due to non-floatable chalcopyrite or linked to the micro inclusions mainly in pyrite, with average grain size of 3 μm . The liberation rate of the chalcopyrite in the tailings increased with particle size decrease, which implied that even at prolonged grinding duration, meaning high energy consumption, the chalcopyrite recovery was unlikely to increase. The reason for the drop in the chalcopyrite recovery can be found in the low level of DO or in the inappropriate choice of collector and high pH.

The EDTA survey enabling to detect iron and copper ions in the pulp suggests that correlating covellite and bornite presence with the process conditions leading to pyrite activation in the copper-selective circuit is an important target for further work.

A recovery model, based on mineralogy and texture, could provide useful information for the overall optimisation of the metallurgical performance, and therefore further work is underway to include detailed MLA of the entire flotation flow-sheet.

Acknowledgements

The authors gratefully acknowledge the support of Dundee Precious Metals Chelopech (DPMCh) for this project and their assistance in sampling collection and pulp survey. One of the authors (DN), wishes to thank the EMERALD ERASMUS-MUNDUS Master course on Geo-resources engineering.

References

- BONEV, I., KERESTEDJIAN, T., ATANASSOVA, R. and ANDREW C., 2002. *Morphogenesis and composition of native gold in the Chelopech volcanic-hosted Au-Cu epithermal deposit, Srednogorie zone, Bulgaria*, Miner. Depos. 37, 6-7, 614-629.
- BULATOVIC, S., 2007. Summary for Policymakers, in *Handbook of Flotation Reagents Chemistry, Theory and Practice: Flotation of Sulfide Ores*, Elsevier Science & Technology Books, Cambridge, 1- 443.
- CHAMBEFORT, I, MORITZ, R., 2014. *Subaqueous environment and volcanic evolution of the Late Cretaceous Chelopech Au-Cu epithermal deposit, Bulgaria*, J. Volcanol. Geotherm. Res., 289, 1-13.
- CHEN, X., SEAMAN, D., PENG, Y., BRADSHAW, D., 2014. *Importance of oxidation during regrinding of rougher flotation concentrates with a high content of sulphides*, Miner. Eng., 66, 165-172.
- CHEN, X., SEAMAN, D., PENG, Y., BRADSHAW, D., 2013. *Effect of regrinding conditions on pyrite flotation in the presence of copper ions*, Int. J. Miner. Process. 125, 129-136.
- JAVADI, A., 2013. *Sulphide Mineral Flotation - a new insides into oxidation mechanisms*. Licenciate thesis, Universitetstryckeriet Luleå Sweden, 162 p.
- KOUZMANOV, K., MORITZ, R., VON QUADT, A., CHIARADIA, M., PEYTCHEVA, I., FONTIGNIE, D., RAMBOZ, C., BOGDANOV, K., 2009. *Late Cretaceous porphyry Cu and epithermal Cu-Au association in the Southern Panagyurishte District, Bulgaria: The paired Vlaykov Vruh and Elshitsa deposits*, Miner. Depos. 44, 6, 611-646
- RUMBALL, J., RICHMOND, G., 1996. *Measurement of oxidation in a base metal flotation circuit by selective leaching with EDTA*, Int. J. Miner. Process. 48, 1-2, 1-20
- STRASHIMIROV, S., PETRUNOV, R., KANAZIRSKI, M., 2002. *Porphyry-copper mineralisation in the central Srednogorie zone, Bulgaria*, Miner. Depos. 37, 6-7, 587-598.