



IMPROVING THE PROCEDURE OF PROBABILISTIC LOAD TESTING DESIGN OF TYPICAL BRIDGES BASED ON STRUCTURAL RESPONSE SIMILARITIES

P. OWERKO¹, K. WINKELMANN²

This paper concerns load testing of typical bridge structures performed prior to operation. In-situ tests of a two-span post-tensioned bridge loaded with three vehicles of 38-ton mass each formed the input of this study. On the basis of the results of these measurements an advanced FEM model of the structure was developed for which the sensitivity analysis was performed for chosen uncertainty sources. Three uncorrelated random variables representing material uncertainties, imperfections of positioning and total mass of loading vehicles were indicated. Afterwards, two alternative FE models were created based on a fully parametrised geometry of the bridge, differing by a chosen global parameter – the skew angle of the structure. All three solid models were subjected to probabilistic analyses with the use of second-order Response Surface Method in order to define the features of structural response of the models. It was observed that both the ranges of expected deflections and their corresponding mean values decreased with an increase of the skewness of the bridge models. Meanwhile, the coefficient of variation and relative difference between the mean value and boundary quantiles of the ranges remain insensitive to the changes in the skew angle. Owing to this, a procedure was formulated to simplify the process of load testing design of typical bridges differing by a chosen global parameter. The procedure allows - if certain conditions are fulfilled - to perform probabilistic calculations only once and use the indicated probabilistic parameters in the design of other bridges for which calculations can be performed deterministically.

Keywords: bridge load testing, imperfections and uncertainties, response surface method, Monte Carlo Simulation, finite element model, design of experiments

¹ Ph.D., Eng., Faculty of Materials, Civil and Environmental Engineering, University of Bielsko-Biala, ul. Willowa 2, 43-300 Bielsko-Biala, Poland, e-mail: powerko@ath.bielsko.pl

² Ph.D., Eng., Faculty of Civil and Environmental Engineering, Gdańsk University of Technology, ul. Narutowicza 11/12, 80-233 Gdańsk, Poland, e-mail: karol.winkelmann@pg.edu.pl

1. INTRODUCTION AND RESEARCH SIGNIFICANCE

In the last two decades intensive development of transportation infrastructure could have been noticed in Central Europe. As an effect a significant increase in the number of road bridges was observable, most of which are typical. They have been classified and described in numerous research papers, e.g. [12,27,38,39] and design catalogues [7,34].

A two-girder post-tensioned concrete bridge is one of the most common. These structures serve most often as two- or three-span viaducts, crossing express roads and highways. Most of them have spans ranging from 20 to 40 m, which qualifies them to undergo load testing prior to opening, performed in e.g. Poland, Slovakia, Spain or Italy [17,28].

Up to the present, the design of load testing and evaluation of its results has been based mostly on deterministic approach [18,19,20,22,25]. However, it is proven in [5,24] that reliability analyses should be a part of load testing of bridges in the context of their load-bearing capacity evaluation. In addition to this, a complex proposal to complement deterministic approach with probabilistic considerations in load testing, performed at the stage of admission of the structure to service, has recently been presented by [28]. Taking into account a great number of discussed typical bridges, it seems reasonable to also perform comparative and sensitivity analyses aimed at finding common features of structural response of these bridges, especially in the view of current discussions about sensibility and economics of load testing of typical structures [13].

An innovative proposal of load testing design based on probabilistic tools given in [28] and chosen in-situ measurements of a typical bridge structure under test loading are the two fundamentals of this paper. Thus, it begins with the description of the course of load tests and their results, given in section “In-situ load testing”. This section also concisely presents the tested bridge and its geometrical and material parameters. Section “Refinement of FE model” is a description of FE models of the bridge. The refinement of a solid model based on the presented in-situ results was also presented. In addition, this section introduces the so-called derivative models, created on the basis of a fully parametrized geometrical model of the presented bridge, differing by a skew parameter of the structure. Section “Uncertainty sources and sensitivity analysis” presents methodology and results of probabilistic sensitivity analyses to the chosen uncertainty sources under consideration during load testing of typical bridges. In section “Comparative probability analyses” the results of computations performed using Response Surface Method are presented in order to collect information on probabilistic properties of structural response of particular models. In the last sections a unification procedure of

load testing design for typical bridges incorporating the probabilistic approach was formulated along with key conclusions and summary of the work.

Therefore, a direct aim of the paper is to compare probabilistic features of structural response of three models of a chosen typical bridge, differing by a selected parameter – the skew angle in this case. This is achieved with the use of parametric models of the bridge, calibrated based on the in-situ tests results. The conclusions drawn from the analyses serve to achieve the second goal of this study – to formulate a unification procedure for load testing design of typical bridge structures prior to opening. Application of the proposed procedure may reduce workload of load testing design preparation of bridges with similar geometry, differing by only one or several parameters.

2. IN-SITU LOAD TESTING

In-situ load testing, to which this study refers, is an important part of decision process of admitting of the bridge to service. The testing have been performed for the bridge under consideration, its structural geometry details and the parameters of used loading vehicles are presented Fig. 1.

It is a two-span road bridge, with span lengths of 30 m each. It consists of two trapezoidal post-tensioned girders and a deck with appropriately shaped cantilevers for sidewalk slabs. Each girder was stressed with four 22-strand tendons with multi-arched layout, preventing the occurrence of tensile stresses greater than the concrete tensile strength (0.05 quantile) under live loads. It is a very common bridge type, constructed as viaducts over highways, express roads or small watercourses.

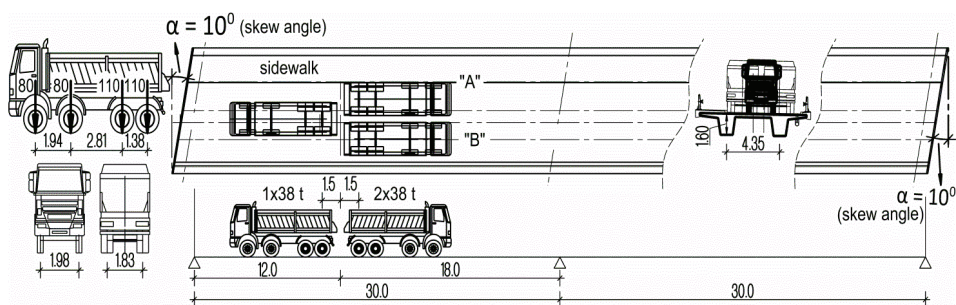

Fig. 1. Sketch of bridge geometry, including loading vehicles positioning

A load testing design was made based on deterministic approach in accordance to standardized guidance [30]. In this context, one of the most important aspects of such admission testing is to compare span deflections under test loading (the measured displacements of the girder are reduced to

account for settlement of supports) and the deflections obtained in a numerical analysis of theoretical FE model. According to [30] the result of the test is positive if the in-situ deflection is smaller than the theoretical one. For this purpose, the most commonly used, deterministic beam FE model of the bridge was created, denoted in this paper as “M0”, shown in Fig. 2a.

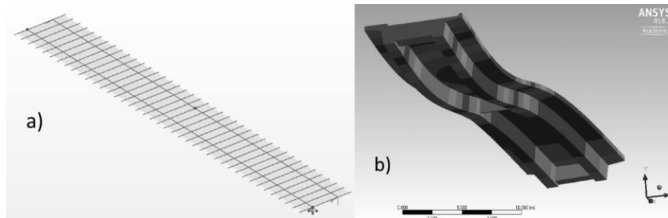

Fig. 2. Visualization of FE models a) grating model – e1p2; b) solid model after calibration – e3p3

With the abovementioned model it was possible to compute appropriate test loading (three 38-ton, 4-axle vehicles, shown in Fig. 2) and determine theoretical values of girders deflections in the FE model. These deflections were compared with the in-situ measurements. None of the measured values exceeded theoretical ones so the admission criterion for deflections was fulfilled. The corresponding deflections from in-situ measurements and the “M0” model are presented in Table 1.

Table 1. Results of deterministic analysis of deflections [mm]

model	α	Girder A		Girder B		sidewalk slabs included?	E [GPa]
		span I	span II	span I	span II		
		min	max	min	max		
-	10°	-6.27	2.44	-7.60	2.70	Yes (in-situ)	
M 0	10°	-7.41	2.93	-8.18	3.10	No	42
M 1	10°	-6.39	2.53	-7.56	2.73	Yes	42
M 2	20°	-6.16	2.32	-7.43	2.63	Yes	42
M 3	30°	-5.79	2.04	-7.18	2.43	Yes	42

3. REFINEMENT OF FE MODEL

In order to perform probabilistic and parametric analyses a new, independent FE model of higher class e3p3 [1] was created with the use of ANSYS® software (Fig. 2b). This model consisted of 301587 nodes and 74359 finite elements. Most of them had the shape of solids bound by six surfaces, with 20 nodes (nodes in the vertices and intermediate nodes) and 3 degrees of freedom in each node

(„solid186”). Quadratic shape functions were used. The remaining elements were analogical 10-node quasi-tetrahedral elements („solid187”). The size of a single element was chosen to be 20 cm, although denser discretization was also checked (15 cm) with two different techniques of elements selection used. Satisfactory compliance of results was achieved – relative differences of deflections did not exceed 0.90%. Given the level of post-tensioning of the structure and its expected capacity use under test loading (about 80% of the effects of characteristic load combination) linear-elastic material model was assumed to be sufficient. Moreover, in the stage of in-situ load testing, the effect of mid-span lift due to post-tensioning is already present. Therefore, it can be omitted in the design of load testing, as only relative deflections are investigated.

One of the key parameters influencing model flexural stiffness is the secant modulus of elasticity of concrete. Its value was determined according to the guidelines of [8] and suggestions of [31] as:

$$E_{cm}(t) = 22 \cdot \left(\frac{f_{cm}}{10} \cdot e^{s \left(1 - \sqrt{\frac{28}{t}} \right)} \right)^{0.3} \cdot \alpha_E \text{ [GPa]}$$

where:

f_{cm} – mean compressive strength of concrete, s – coefficient dependent on the type of cement, α_E – coefficient dependent on the type of aggregate, t – time between concrete placement and loading

The secant modulus of elasticity was calculated equal to 42 MPa. Assuming the calculated value of the modulus, first FE simulation was performed. The model was loaded in a manner shown in Fig. 1. The obtained deflections approximated the in-situ measurements more accurately than the grating model (Table 1). However, the response of the solid model in transverse direction did not sufficiently reflect the measured one. That is why it was modified to account for the fact that sidewalk slabs had already been present at the moment of testing. Thus, the model was refined and the height of the sidewalk slabs was properly reduced to apply a single, global value of the modulus of elasticity (the same as in the load-bearing structure), similarly to calculations of composite structures. This way the “M1” model was created, shown in Fig. 2b. This correction resulted in two benefits: a more accurate proportion of girders deflections (transverse behavior of the model) and a better estimation of theoretical deflections in comparison to the measured ones (Table 1). Given the accuracy of measurements in the in-situ tests [3,9] the obtained theoretical results can be regarded as satisfactory. Thus, this model was used in the subsequent probabilistic and comparative analyses.

4. UNCERTAINTY SOURCES AND SENSITIVITY ANALYSIS

As observed in [28], it is worth to extend deterministic designs of load testing with probabilistic analyses. Appropriate identification of uncertainty sources should be their starting point. This leads to a computation of a probable range of structural response and not basing on a single, deterministic admission value, e.g. allowable deflection of a girder. In case of load testing of bridges, regarding analysis of deflections (settlements of supports are accounted for in the measurement algorithm) the following uncertainty sources can be distinguished:

- material parameters of the bridge, e.g. modulus of elasticity [12,16,35,36],
- geometrical imperfections imposed during execution [6,27,36],
- stiffness of individual load-bearing elements, e.g. due to possible cracking [18],
- vehicle loading: values of loads per particular axles, axle base dimensions, setup of vehicles on the bridge [10,26,36], and pedestrian loading in case of footbridges [35],
- influence and stage of completion of the bridge equipment [22],
- thermal conditions during measurements [40],
- measurements inaccuracy [3],
- the class and response of theoretical model [1,25].

An exhaustive list of uncertainty sources has been presented in [28] (in the aspect of load testing), and in [36] (in the aspect of reliability assessment during service). The quantity and significance of these uncertainties change depending on the moment when load testing is performed, especially when the data from on-site surveyors and laboratories is available. In case of the analysed bridge and its related design three most important uncertainty sources were identified:

value of the secant modulus of elasticity of concrete, represented by random variable X_1 ,

total mass of loading vehicles, represented by random variable X_2 , imperfections of the loading vehicles positioning with respect to design given specifications – both in transverse (random variable X_3) and longitudinal (random variable X_4) direction.

X_1 was assumed log-normal, with an expected value of $\mu_1 = 42$ GPa and a coefficient of variation $\nu_1 = 15\%$, according to JCSS instructions [31]. However, if on-site laboratory data on the concrete compression tests is available, the parameters of X_1 may be calibrated accordingly. X_2 has a normal distribution, with an expected value $\mu_2 = 3 \cdot 38 \text{ t} = 114 \text{ t}$ and a coefficient of variation $\nu_2 = 2.5\%$ (analogically to [28]). X_3 is described with a chi-square distribution with one degree of freedom,

scaled by 0.10. With such an adoption, the most probable values of the distribution correspond to proper (design-complying) transverse positioning of the vehicles, according to Fig. 3.

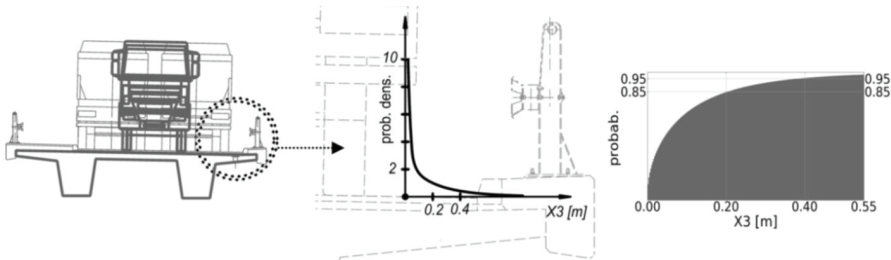

Fig. 3. Variable X_3 represented by its probability density function and cumulative distribution function

With this form, the modal value of X_3 is equal to 0.00, while the 85% and 95% of its sample population lies in the range of 0-0.20 and 0-0.40 m, respectively (Fig. 3). Probability of encountering samples with a value exciding 0.55 m (the distance between the tyre edge and the curb) is lesser than 2%. This corresponds to a design situation quite well, as the error in transverse positioning of loading vehicles greater than 0.55 m would require either running on the curb, or having unusually thin tires while misreading the design guidelines. The variable X_4 representing imperfections in longitudinal positioning of loading vehicles has a normal distribution with an expected value of $\mu_4 = 0.00$ m and standard deviation of $\sigma_4 = 0.20$ m.

The remaining uncertainty sources were omitted due to the expected conditions in which measurements would be performed (e.g. nearly constant temperature of the bridge during testing) as well as information from the construction site (surveyors reports, information on the equipment of the bridge, information on the level of post-tensioning – elimination of cracking).

Sensitivity analysis began with a study on the influence of an error in longitudinal positioning of the loading vehicles on deflections determined in “M1” FE model shown in Fig. 2b. In numerical simulations maximum deflections of girders were investigated depending on the value of particular random variables, step-changed by a value of standard deviation for X_1, X_2, X_4 or by 0.20 m for X_3 . The corresponding results are collectively presented graphically in Fig. 4, where the k parameter denotes the multiplier of standard deviation e.g. $X_1(k=2) = \mu_{X_1} - 2 \cdot \sigma_{X_1}$ for normal variables X_1, X_2, X_4 or k denotes modal value (if $k=0$), 85th percentile (if $k=1$) and 95th percentile (if $k=2$) for the chi-square variable X_3 .

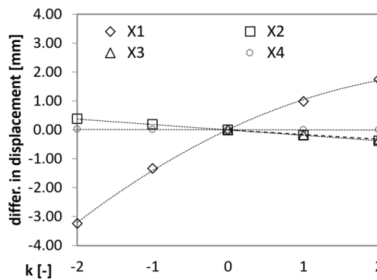

Fig. 4. Results of sensitivity analyses of model “M1”

Analysing Fig. 4 it can be concluded that the deflections results are almost insensitive to the local imperfections in longitudinal positioning of the vehicles (variable X_4). For the analysed values of X_4 the differences in corresponding deflections did not exceed 0.03 mm. In contrast, the influence of imperfection in transverse positioning of the vehicles (variable X_3) on the maximum displacement of girder “B” is comparable to the influence of variability of the total mass of the vehicles (variable X_2). Variable X_1 , representing uncertainty of the secant modulus of elasticity of concrete (and the corresponding shear modulus), is the most significant, showing non-linear impact on the analysed response of the FE model. Hence, in further analyses only X_1 , X_2 and X_3 were taken into account while the effect of X_4 was recognised as negligible.

5. COMPARATIVE PROBABILITY ANALYSES

5.1. DERIVATIVE MODELS – CHANGE OF BRIDGE SKEW ANGLE

In the next analysis step a fully parametric model of bridge geometry was built based on a script language Tool Command Language (TCL) and commercial environment Allplan Bridge® (Fig. 5). Such an approach allowed for an effective way of generating alternative input files in chosen FE system. In addition to the basic model with a skew angle of $\alpha = 10^\circ$ (model “M1”), two additional models were created with a skew angle of $\alpha = 20^\circ$ (model “M2”) and $\alpha = 30^\circ$ (model “M3”). In each model a scheme of the loading vehicles used in the in-situ tests was modified, pertaining constant distance of the vehicles axles from theoretical axis of the bridge support. Deflections results of deterministic FE simulation of “M1”, “M2” and “M3” models are shown in Table 1. The maximum deflection of girders decreases with an increase of the skew angle of the structure.

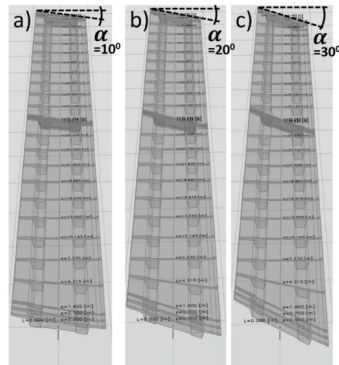

Fig. 5. Visualization of parametric models a) "M1", b) "M2", c) "M3"

5.2. PROBABILISTIC COMPARISON OF STRUCTURAL RESPONSE

Deterministic analyses of models "M1", "M2" and "M3" were extended by introducing representation of corresponding uncertainty sources based on the "design of experiments" methodology [15]. This was done in the pre-processor used in the FE system according to the parameters of random variables X_1 , X_2 and X_3 in characteristic „design points”, as shown in Fig. 6. For X_1 and X_2 this refers to the expected values and values „shifted” by an integer multiplier of standard deviation (see Table 2). For X_3 these characteristic points are the modal value, and the 85th and 95th percentile of its cumulative distribution function (Fig. 3).

The results presented in Table 2 related to the model „M1” were further enhanced by additional design points (so-called „corner points”), as shown in Fig. 6.

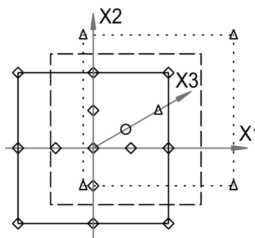

Fig. 6. Method of design points selection

Analogical calculations were performed for the “M2” and “M3” models. 15 design points per model were created, so 45 FE simulations in total. Such an approach allowed to approximate structural response of these models, in terms of deflections induced by test loading, using polynomial functions according to the Response Surface Method (RSM) [2]. This method is frequently used in probabilistic analyses of bridge structures [4,11,23,32]. Two types of approximating polynomials were used in calculations. In majority of civil engineering analyses first-order polynomial is used:

$$\bar{U}(X) = \beta_0 + \sum_{i=1}^n \beta_i X_i$$

where:

β_0 – elevation coefficient, β_i – coefficients of regression (slope gradients), X_i – analysed random variables, $\bar{U}(X)$ – approximation function of structural response of FE models (vertical deflections of girder “B” in presented example)

However, due to observable nonlinearity displayed by variable X_1 a more advanced polynomial was considered, namely the quadratic function of random variables with cross-terms:

$$\bar{U}(X) = \beta_0 + \sum_{i=1}^n \beta_i X_i + \sum_{i=1}^n \beta_{ii} X_i^2 + \sum_{i < j}^n \sum_{j=2}^n \beta_{ij} X_i X_j$$

This method of approximation requires greater computation effort than in case of the first-order function, however, it provides more accurate description of structural response of bridges.

Optimal response surface was sought two ways: in Python® environment with the use of Sci-kit-learn [29], and Scipy libraries [14] and independently using a proprietary RSM-Win® software developed in Fortran 90® [37]. In both cases the least square method was used, although minimisation of the approximation error is realised differently. Sci-kit-learn adopts singular value decomposition of design matrix technique, while in RSM-Win® the tabular ANOVA (Analysis of Variance) method is incorporated [33]. Independently of the environment used, analogical results of RSM analyses and corresponding β coefficients were obtained.

Both tools showed a significant difference in the quality of approximation between the first-order and second-order models. For example, structural response of “M1” model in terms of maximum deflections of girder “B” approximated with the first-order polynomial gave unsatisfactory coefficient

of determination $R^2 = 0.97$ and mean square error $\mu_{SQE} = 0.13$ mm, while application of the second-order function led to significant improvement of these indicators - $R^2 = 1.00$ R and $\mu_{SQE} = 0.01$ mm were obtained. Therefore, further probabilistic and comparative analyses were conducted with the use of the second-order model.

The search for probable ranges of deflections of particular models was conducted with discrete sampling from the determined approximation function. The Monte Carlo method with 10^5 random trials was used for each assessed surface to reach a satisfactory convergence (iteration discrepancy lower than 0.01), with creation of appropriate cumulative histograms of high numerical quality. Because the analyses considered typical bridges, the suggested ranges for admission of the structure to service with respect to the deflection criterion were narrowed down from 95% to 90% of most probable results [28]. The final results were presented in Fig. 7 and Table 2.

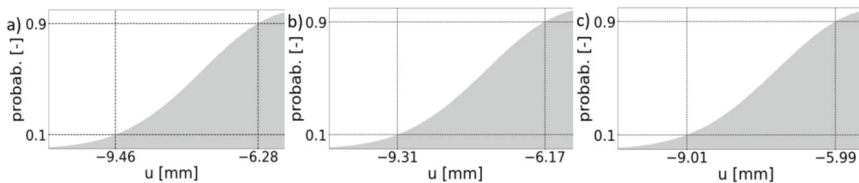

Fig. 7. Probable ranges of struct. response – deflections [mm], in regard to model a) “M1”, b) “M2”, c) “M3”

Table 2. Observations regarding deflections [mm] resulting from performed simulations

Model/ skew angle	Deterministic deflection [mm]	Lower limit of the deflection range (0.10 quantile) [mm]	Upper limit of the deflection range (0.90 quantile) [mm]	Coefficient of variation of function $\bar{U}(x)$
“M1”/ 10°	$U_{det}^{10} = -7.56$	$\bar{U}_{0.1}^{10} = -9.43$	$\bar{U}_{0.9}^{10} = -6.28$	$c_v^{10} = 0.156$
“M2”/ 20°	$U_{det}^{20} = -7.43$	$\bar{U}_{0.1}^{20} = -9.31$	$\bar{U}_{0.9}^{20} = -6.17$	$c_v^{20} = 0.156$
“M3”/ 30°	$U_{det}^{30} = -7.18$	$\bar{U}_{0.1}^{30} = -9.01$	$\bar{U}_{0.9}^{30} = -5.99$	$c_v^{30} = 0.156$

It can be concluded from Table 2 that both deterministic values of deflections and their probable interval range decreased from 3.15 mm (in “M1” model) to 3.02 mm in “M3” model with increasing α angle. Contrarily, the value of the coefficient of variation of approximating functions $\bar{U}(X)$ (a quotient of standard deviation and mean value of realisations of this function) is insensitive to the change of α and equals to $c_v = 0.156$ in all three considered models “M1”, “M2”, “M3”. Similar observation can be made regarding the relative differences between deterministic values of

deflections and chosen quantiles of realisations of $\bar{U}(X)$ function (κ_1^α and κ_2^α). They can be determined in all three models according to:

$$\kappa_1^\alpha = \frac{U_{\det}^\alpha - U_{0.1}^\alpha}{U_{\det}^\alpha} = 0.17 ; \quad \kappa_2^\alpha = \frac{U_{\det}^\alpha - U_{0.9}^\alpha}{U_{\det}^\alpha} = 0.25 ; \quad \alpha \in \{10^\circ; 20^\circ; 30^\circ\}$$

6. SIMPLIFYING PROCEDURE

The results of simulations and computations presented in this paper allowed to formulate a hypothesis that the skew angle of two-girder post-tensioned bridges of the discussed type does not influence the previously defined values c_ν , κ_1^α and κ_2^α . Therefore, a preliminary procedure was defined (Fig. 8) for simplification of the load testing design process in case of several tests of similar structures differing by geometrical parameters (skew angle of a bridge in the example). This is a frequent situation, especially during realisation of large-scale highways or express roads.

It should be emphasised, that the computational procedure application should be preceded by an analysis concerning the specific guidelines regarding in-situ load testing outlines valid in a given country. Due to a high variety of regulations in the country-specific documents, this analysis requires an individual, experience-based approach and cannot be automated.

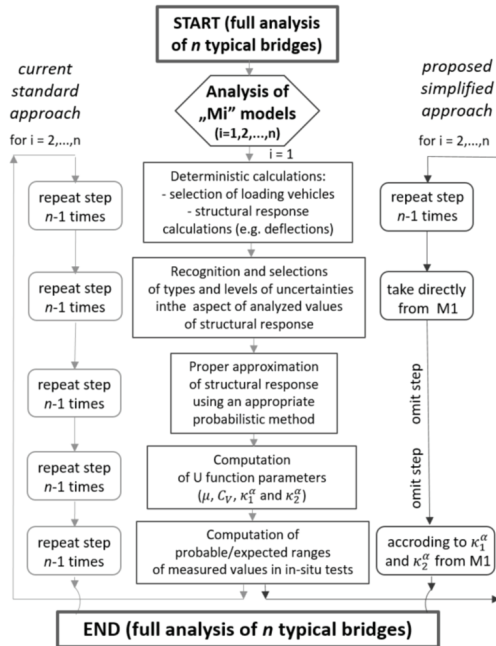

Fig. 8. Graphical interpretation of proposed simplifications

The main idea of this proposal is to perform only one approximation of the response function. The remaining structures can be analysed deterministically and the corresponding range of a probable response of the bridge is obtained based on the probabilistic parameters computed in the first analysis. This can be done according to

$$\begin{aligned} \wedge_{i \neq 1} \bar{U}_{0.1}^{M_i} &= U_{\det}^{M_i} - U_{\det}^{M_1} \cdot \kappa_1^{M_i} \\ \wedge_{i \neq 1} \bar{U}_{0.9}^{M_i} &= U_{\det}^{M_i} + U_{\det}^{M_1} \cdot \kappa_2^{M_i} \end{aligned}$$

Such an approach allows to accelerate the load testing design process and to reduce the costs of documentation preparation, without losing its credibility. It should be, however, emphasised that to apply such simplification the designer must be certain about similarity of parameters describing the uncertainties' significance in load testing of particular bridges.

7. SUMMARY AND CONCLUSIONS

This study investigated possibilities to increase efficiency of preparation of load testing designs of typical bridge structures prior to their admission to service. As an example a real post-tensioned bridge and the results of its in-situ tests are analysed together with its hypothetical, FE-based derivative models differing by a chosen geometrical parameter – skew angle of the structure. Computations were performed both deterministically and probabilistically. This example is limited to analysis of the maximum deflections of one of the girders. The following essential observations and conclusions can be drawn from the study:

- In-situ deflections (displacements were reduced to account for the effect of the settlement of supports and bearings compression) were smaller than the ones determined theoretically in a grating model. There was no basis to reject the bridge from service based on the deflection criterion.
- The results of structural response from the grating deterministic model differed significantly from the measurements results. A more advanced, solid model was built independently for further comparative analyses.
- A fully parametrised geometry of the bridge was defined for the computational example. This allowed to create two additional solid models differing by a skew angle α . Deterministic calculations performed on all three models indicated a decrease of theoretical deflections induced by test loading with the increase of the skew angle.
- Sensitivity analyses to chosen uncertainty sources indicated that it is necessary to account for three uncorrelated random variables. They represent uncertainties related to material properties of concrete, the total mass of loading vehicles and possible imperfections in their transverse positioning. It was proven that local imperfections in longitudinal positioning are negligible in the discussed case.
- Probabilistic calculations were conducted with the use of RSM and MCS. Second-order model was proven indispensable to achieve satisfactorily accurate approximation of structural response. This method was used to find probable (expected in the in-situ measurements) ranges of deflections. Their range was decreasing with respect to the decreasing α angle. The coefficient of variation of approximating functions was almost identical in all three cases. The same observation was made on the differences between mean deflections and identified values of boundary quantiles.

- Conclusions drawn from the study allowed to formulate a simplification proposal of load testing design of typical bridge structures differing by a chosen global parameter. In this approach probabilistic calculations are performed only once (for one bridge); while the remaining bridges can be analysed deterministically on the basis of appropriate probabilistic ranges calculated for the first model.

Summarising, the use of existing results of in-situ loading tests for calibration of not only numerical models but also parameters of random variables representing particular uncertainty sources in the designs of future tests is an innovative yet adequate approach. The proposed procedure limits workload in preparation of project documentation for test loading of typical bridges.

ACKNOWLEDGEMENTS

The authors would like to express their gratitude for the possibility of conducting simulations of solid FE models using “PLGrid” – The Polish Grid Infrastructure (NGI) and to Mr. Grzegorz Łaba for co-participation in conducting original load tests of the bridge considered in the paper.

REFERENCES

1. J. Bień, M. Kuźawa, T. Kamiński, “Validation of numerical models of concrete box bridges based on load test results”, *Archives of Civil and Mechanical Engineering* 15(4): 1046–1060, 2015.
2. G. E. P. Box, K. B. Wilson, “On the Experimental Attainment of Optimum Conditions”, *Journal of the Royal Statistical Society. Series B (Methodological)* 13(1): 1–45, 1951.
3. T. Braml, A. Taffe, S. Feistkorn, O. Wurzer, “Assessment of Existing Structures using Probabilistic Analysis Methods in Combination with Nondestructive Testing Methods”, *Structural Engineering International* 23(4): 376–385, 2013.
4. J. Cheng, R. Xiao, “Probabilistic free vibration and flutter analyses of suspension bridges”, *Engineering Structures* 27(10): 1509–1518, 2005.
5. H.-N. Cho, Y.-M. Choi, B.-C. Sho, “Field load testing and reliability-based integrity assessment of segmental PC box girder bridges before opening to traffic”, *Engineering Structures* 20: 948–956, 1998.
6. J. Cieśla, M. Biskup, Ł. Topczewski, M. Skawiński, “Cases of failure of bridge structures during the process of pre-stressing”, *Roads and Bridges - Drogi i Mosty* 1: 15–35, 2017.
7. B. Endres, M. Wagner, V. Marg, H. Nienhoff, M. Pfisterer, W. Eilzer, M. Kwiatkowski, “Design manual BAB A3—Würzburg to Erlangen” (Ed. S. Altrock), 2017.
8. Eurocode 2. Design of concrete structures – Part 1-1: General rules and rules for buildings, 2004.
9. J. Gocał, Ł. Ortył, T. Owerko, P. Kuras, R. Kocierz, P. Cwiąkała, A. Bałut, “Determination of displacements and vibrations of engineering structures using ground-based radar interferometry”, 2013.
10. T. Guo, D. M. Frangopol, Y. Chen, “Fatigue reliability assessment of steel bridge details integrating weigh-in-motion data and probabilistic finite element analysis” *Computers & Structures* 112–113: 245–257, 2012.
11. K. Haciefendioğlu, H. B. Başağa, S. Banerjee, “Probabilistic analysis of historic masonry bridges to random ground motion by Monte Carlo Simulation using Response Surface Method”, *Construction and Building Materials* 134: 199–209, 2017.
12. M. Hassan, O. Burdet, R. Favre, “Ultrasonic measurements and static load tests in bridge evaluation”, *NDT&E International* 28(6): 331–337, 1995.
13. D. Hester, J. Brownjohn, M. Bocian, Y. Xu, “Low cost bridge load test: Calculating bridge displacement from acceleration for load assessment calculations”, *Engineering Structures* 143: 358–374, 2017.
14. E. Jones, T. Oliphant, P. Peterson, “SciPy: Open Source Scientific Tools for Python”, 2001.

15. R. W. Kennard, L. A. Stone, "Computer Aided Design of Experiments", *Technometrics* 11(1): 137–148, 1969.
16. A. Knoppik-Wróbel, B. Klemczak, "Degree of restraint concept in analysis of early-age stresses in concrete walls", *Engineering Structures* 102: 369–386, 2015.
17. M. Łagoda, "Potrzeba wykonywania badań konstrukcji mostowych pod próbnym obciążeniem statycznym i dynamicznym", Wrocław's Bridge Days seminar, Wrocław, Poland, 2013.
18. E. O. L. Lantsoght, C. van der Veen, A. de Boer, D. A. Hordijk, "State-of-the-art on load testing of concrete bridges", *Engineering Structures* 150: 231–241, 2017.
19. E. O. L. Lantsoght, C. van der Veen, D. A. Hordijk, A. de Boer, "Development of recommendations for proof load testing of reinforced concrete slab bridges", *Engineering Structures* 152: 202–210, 2017.
20. M. Laura, C. Francesco, F. Antonio, "Static and dynamic testing of highway bridges: A best practice example", *Journal of Civil Structural Health Monitoring* 10: 43–56, 2020.
21. P. Łaziński, "Procedura modelowania obiektów rzeczywistych w postaci pewnego typu konstrukcji mostowych", 2009.
22. P. Łaziński, M. Salamak, "Load test of extremely wide extradosed concrete bridge", *Proceedings of the 11th Central European Congress on Concrete Engineering CCC 2015*: 302–305, 2015.
23. A. S. Nowak, T. Cho, "Prediction of the combination of failure modes for an arch bridge system", *Journal of Constructional Steel Research* 63(12): 1561–1569, 2007.
24. A. S. Nowak, T. Tharmabala, "Bridge Reliability Evaluation Using Load Tests", *Journal of Structural Engineering* 114(10): 2268–2279, 1988.
25. P. Ołaszek, M. Łagoda, J. Ramon Casas, "Diagnostic load testing and assessment of existing bridges: Examples of application", *Structure and Infrastructure Engineering* 10(6): 834–842, 2014.
26. P. Owerko, "The stochastic finite element method in the assessment of bridge infrastructure objects – Review", *E3S Web of Conferences* 45: 00062, 2018.
27. P. Owerko, M. Honkisz, "Innovative technique for identification of prestressing tendons layout in post-tensioned bridges using a probe with MEMS accelerometer", *Structure and Infrastructure Engineering* 13(7): 869–881, 2017.
28. P. Owerko, K. Winkelmann, J. Górski, "Application of probabilistic tools to extend load test design of bridges prior to opening", *Structure and Infrastructure Engineering* 16(7): 931–948, 2020.
29. F. Pedregosa, G. Varoquaux, A. Gramfort, V. Michel, B. Thirion, O. Grisel, É. Duchesnay, "Scikit-learn: Machine Learning in Python", *Journal of Machine Learning Research* 12: 2825–2830, 2011.
30. PN-S-10040. "Obiekty mostowe: Konstrukcje betonowe, żelbetowe i sprężone; Wymagania i badania", 1999.
31. Probabilistic Model Code—JCSS, 2018.
32. L. Sgambi, E. Garavaglia, N. Basso, F. Bontempi, "Monte Carlo simulation for seismic analysis of a long span suspension bridge", *Engineering Structures* 78: 100–111, 2014.
33. S. S. Shapiro, M. B. Wilk, "An analysis of variance test for normality (complete samples)", *Biometrika* 52(3/4): 591–611, 1965.
34. T. Siwowski, E. Michałak, D. Kaleta, E. Reizer, D. Macheta, "Katalog typowych konstrukcji drogowych obiektów mostowych i przepustów", 2018.
35. J. Szafran, M. Kamiński, "Bridges for Pedestrians with Random Parameters using the Stochastic Finite Elements Analysis", *International Journal of Applied Mechanics and Engineering* 22(1): 175–197, 2017.
36. D. V. Val, M. G. Stewart, R. E. Melchers, "Life-Cycle Performance of RC Bridges: Probabilistic Approach", *Computer-Aided Civil and Infrastructure Engineering* 15(1): 14–25, 2000.
37. K. Winkelmann, "Probabilistic Methods in Reliability Assessment of Engineering Lightweight Structures", *XXIV Lightweight Structures in Civil Engineering – Contemporary Problems*: 147–157, 2018.
38. V. Yepes, J. V. Martí, T. García-Segura, F. González-Vidosa, Heuristics in optimal detailed design of precast road bridges", *Archives of Civil and Mechanical Engineering* 17(4): 738–749, 2017.
39. W. Zhang, C. S. Cai, F. Pan, "Nonlinear fatigue damage assessment of existing bridges considering progressively deteriorated road conditions", *Engineering Structures* 56: 1922–1932, 2013.
40. G.-D. Zhou, T.-H. Yi, "Thermal Load in Large-Scale Bridges: A State-of-the-Art Review", *International Journal of Distributed Sensor Networks* 9(12): 217983, 2013.

LIST OF FIGURES AND TABLES:

Fig. 1. Sketch of bridge geometry, including loading vehicles positioning

Rys. 1. Szkic geometrii mostu, z ukazaniem pozycjonowania pojazdów obciążających

Fig. 2. Visualization of FE models a) grating model – e1p2; b) solid model after calibration – e3p3

Rys. 2. Wizualizacja modeli MES a) model rusztowy – e1p2; b) model bryłowy po kalibracji – e3p3

Fig. 3. Variable X_3 represented by its probability density function and cumulative distribution function

Rys. 3. Zmienna X_3 przedstawiona poprzez jej funkcję gęstości prawdopodobieństwa i dystrybuantę

Fig. 4. Results of sensitivity analyses of model "M1"

Rys. 4. Rezultaty analizy wrażliwości modelu "M1"

Fig. 5. Visualization of parametric models a) "M1", b) "M2", c) "M3"

Rys. 5. Wizualizacja modeli sparametryzowanych a) "M1", b) "M2", c) "M3"

Fig. 6. Method of design points selection

Rys. 6. Metoda wyboru punktów projektowych

Fig. 7. Probable ranges of structural response – deflections [mm], in regard to model a) "M1", b) "M2", c) "M3"

Rys. 7. Prawdopodobne zakresy odpowiedzi konstrukcji – ugięcia [mm] w odniesieniu do modelu a) "M1", b) "M2", c) "M3"

Fig. 8. Graphical interpretation of proposed simplifications

Rys. 8. Interpretacja graficzna zaproponowanych uproszczeń

Tab. 1. Results of deterministic analysis of deflections [mm]

Tab. 1. Rezultaty deterministycznej analizy ugięć [mm]

Tab. 2. Observations regarding deflections [mm] resulting from performed simulations

Tab. 2. Spostrzeżenia odnośnie ugięć [mm] płynące z przeprowadzonych symulacji

WZBOGACENIE PROCEDURY PROBABILISTYCZNEGO PROJEKTOWANIA PRÓBNEGO OBCIĄŻENIA MOSTÓW TYPOWYCH NA PODSTAWIE CECH WSPÓLNYCH MECHANICZNEJ ODPOWIEDZI KONSTRUKCJI

Słowa kluczowe: *próbné obciążenia mostów, imperfekcje i niepewności, metoda powierzchni odpowiedzi, symulacja Monte Carlo, Metoda Elementów Skończonych, projektowanie eksperymentów*

STRESZCZENIE:

Pracę otwiera przegląd najnowszej literatury fachowej o zasięgu międzynarodowym, dotyczącej próbných obciążeń obiektów mostowych. W licznych publikacjach badawczych jednoznacznie stwierdzono, iż zasadne jest, by często stosowane w tym zakresie metody deterministyczne uzupełniać lub zastępować analizami probabilistycznymi. Niniejsza praca stanowi zatem rozwinięcie dotychczasowych osiągnięć i spostrzeżeń.

Przedmiotem pracy jest analiza możliwości zwiększenia efektywności procesu przygotowania probabilistycznych projektów próbných obciążeń typowych konstrukcji mostowych, różniących się wybranym parametrem geometrycznym (w tym przypadku – kątem ukosu konstrukcji „ α ”) przed ich dopuszczeniem do eksploatacji w zakresie pomiarów statycznych.

Punktem wyjściowym przedstawionej analizy jest próbné obciążenie in-situ typowego, drogowego mostu sprężonego. Jednym z podstawowych kryteriów dopuszczenia obiektu mostowego do użytkowania w niektórych krajach, jest wykazanie, iż ugięcia dźwigarów głównych obiektu mostowego wywołane statycznym obciążeniem próbnym są mniejsze niż te określone teoretycznie w modelu MES obiektu. W pierwszej kolejności zatem, wyniki pochodzące z rzeczywistych badań próbného obciążenia zostały zestawione z ich teoretycznymi odpowiednikami, pochodzącymi z prostego modelu rusztowego mostu. Ten przykład ogranicza się do analizy maksymalnych ugięć jednego z dźwigarów głównych obiektu. Wykazano, iż ugięcia z pomiarów in-situ (pomierzone przemieszczenia zostały odpowiednio przeliczone na ugięcia, aby uwzględnić wpływ osiadania podpór i zgniotów łożysk) były mniejsze niż te określone teoretycznie. Nie było zatem podstaw do niedopuszczenia mostu do użytkowania ze względu na niespełnienie kryterium ugięć.

Jednakże, w rezultacie analizy wykazano, iż wyniki odpowiedzi konstrukcji z prostego modelu deterministycznego różniły się znacznie od wyników pomiarów. W związku z tym, w celu opracowania procedury zwiększenia efektywności procesu przygotowywania probabilistycznych projektów próbnych obciążeń obiektów typowych, do dalszych analiz porównawczych i probabilistycznych wygenerowany został znacząco bardziej zaawansowany model bryłowy MES.

W przykładzie obliczeniowym zdefiniowano w pełni sparametryzowaną geometrię mostu. Pozwoliło to łatwo stworzyć dwa dodatkowe modele bryłowe różniące się kątem ukosu „ α ”. Rozpęto od obliczeń deterministycznych, które zostały przeprowadzone na wszystkich trzech modelach. Zaobserwowano zmniejszenie teoretycznych ugięć wywołanych obciążeniem próbnym wraz ze wzrostem kąta ukosu konstrukcji. Wygenerowane trzy modele bryłowe zostały w dalszym etapie pracy poddane analizom probabilistycznym w celu określenia podstawowych parametrów ich odpowiedzi, począwszy od standardowej analizy wrażliwości. Analiza wrażliwości odpowiedzi konstrukcji na odpowiednio wybrane źródła niepewności wykazała, że konieczne jest uwzględnienie trzech nieskorelowanych zmiennych losowych. Reprezentują one niepewności właściwości materiału betonu oraz niepewności związane z pojazdami obciążającymi – imperfekcje masy całkowitej i niedokładności ich pozycjonowania, wyłącznie poprzecznego. Wykazano, że wpływ lokalnych niedoskonałości pozycjonowania wzdłużnego na odpowiedź konstrukcji są w omawianym przypadku znikome. Kolejno, przeprowadzono pogłębione analizy probabilistyczne z wykorzystaniem metody powierzchni odpowiedzi (RSM) i symulacji Monte Carlo (MCS). Wykazano, że model powierzchni odpowiedzi drugiego rzędu jest niezbędny do osiągnięcia zadowalająco dokładnego przybliżenia odpowiedzi konstrukcji.

Metodę RSM wykorzystano do ustalenia prawdopodobnych (oczekiwanych w pomiarach in-situ) zakresów ugięć. Zaobserwowano, iż zarówno zakresy mierzonych ugięć, jak i odpowiadające im wartości średnie zmniejszały się wraz ze wzrostem skosu modeli mostu. Jednocześnie, współczynnik zmienności funkcji aproksymacyjnych był prawie identyczny we wszystkich trzech przypadkach. Tej samej obserwacji dokonano analizując znormalizowane różnice między średnimi ugięciami, a wartościami kwantyli brzegowych.

Wnioski wyciągnięte z analizy probabilistycznej pozwoliły na sformułowanie propozycji procedury uproszczenia projektowania próbnego obciążenia typowych konstrukcji mostowych różniących się wybranym parametrem globalnym w aspekcie testów statycznych. Sytuacja, w której na danym kontrakcie infrastrukturalnym, do przetestowania jest kilka lub nawet kilkanaście bardzo podobnych konstrukcji jest dość częsta. W proponowanej procedurze obliczenia probabilistyczne są wykonywane tylko jednokrotnie (dla jednego mostu), a parametry probabilistyczne wyprowadzone dla obiektu pierwszego są ekstrapolowane na pozostałe obiekty (w celu projektowania próbnego obciążenia innych mostów). Pozwala to na ograniczenie się wyłącznie do deterministycznej analizy tychże mostów, przypisując im z góry odpowiednie zakresy parametrów probabilistycznych wyprowadzonych z pierwszego modelu.

Podsumowując, uważa się że wykorzystanie istniejących wyników testów obciążenia in-situ do kalibracji nie tylko wyjściowych modeli numerycznych, ale także parametrów zmiennych losowych reprezentujących szczególne źródła niepewności w projektach przyszłych testów próbnego obciążenia jest innowacyjnym i właściwym podejściem. Proponowana procedura ogranicza znacząco nakład pracy związany z przygotowaniem dokumentacji projektowej do testowego obciążenia typowych mostów różniących się wybranym parametrem globalnym.