

Liucija Berežanskytė*, Tiziana Campisi**

The traditional sacral wooden construction in Lithuania between XVIII and XIX century

Tradycyjne litewskie drewniane budownictwo sakralne z XVIII i XIX wieku

Key words: Lithuania, church, wood, construction, technics, heritage

Słowa kluczowe: Litwa, kościół, drewno, konstrukcja, technika, dziedzictwo

1. INTRODUCTION

Lithuania has exceptionally a rich heritage of wooden buildings, most of which has been realized between the 18th and 19th centuries. This architecture includes private and public buildings, and it is mostly prevalent in villages and towns, as well as in large cities and also in inaccessible areas, where the architectures are intimately related with landscape and nature. The most valuable architectures are the sacred ones, which are characterized by their interesting stilish and structural solutions, rich of historic values and presenting different volumetric shapes and sizes. In Lithuania we can enumerate 265 wooden churches, 100 chapels, 220 bell towers, 13 orthodox churches, 13 wooden synagogues and an unknown number of other sacral buildings [1]. In this country the Catholic faith has been always prevailed, therefore a large number of churches has been produced. The places chosen for the construction of a church usually were well visible, so that the bell towers and the church volumes could be seen immediatly and the sound of church bells could be also heard from afar.

The size of the building has been defined by the number of the community people where a new church must be built. These sacred buildings become so an integral part of every citizen's life, in occasion of the Sunday Mass, Christmas and Easter time, baptism, wedding, funeral and other important events (fig. 1) [2].



Fig. 1. Catholic Churches in Plateliai (1744) and in Palūšė (1757)

* Phd Student, Department of Architecture, University of Palermo, Italy

** Assistant professor, Department of Architecture, University of Palermo, Italy

Cytowanie / Citation: Berežanskytė L, Campisi T. The traditional sacral wooden construction in Lithuania between XVIII and XIX century. *Wiadomości Konserwatorskie – Journal of Heritage Conservation* 2016;46:98-108

Otrzymano / Received: 29.10.2015 • **Zaakceptowano / Accepted:** 19.11.2015

doi:10.17425/WK45LITHUANIA

Praca dopuszczona do druku po recenzjach

Article accepted for publishing after reviews

The wooden Orthodox churches are less, and only 13 remain in the Country. These churches were built along the main streets, often in remote or hardly reachable places, such as the forested areas. Regularly they have a medium size, particularly adorned and usually painted using a blue color. The land around the church is surrounded by a wooden or metal fence. They are easily recognizable by their bulbous domes, and they preserve their original characters that during the centuries haven't undergone because of drastic transformations. The Orthodox churches remain without function and abandoned, furthest from the large urban centers, where the number of believers is been decreased (fig. 2).



Fig. 2. Orthodox churches in Panevėžys (1892), Kaunatava (1894), Lebeniškiiai (1909)

The first Jewish religious buildings in Lithuania had been realized in the 14th century, and today only 13 wooden synagogues are remained; the biggest part of these religious buildings were been destroyed, in fact, during the Second World War. Unlike the Roman Catholic churches, the synagogues were frequently built in urban context, distinguished and manifesting their differences from the other buildings through their roof volume. Those constructions are the result of several factors: the hybridization between the original type of synagogue and it's conversion done by the lithuanian workers; the introduction of different decorative elements, and also the strict rules imposed on Jewish for the construction in the Lithuanian territory. These buildings were realized with squared section logs, based

on stone or bricks foundations, presenting a mansard or different volumes in correspondence of roof. During the evolution of construction techniques, the interiors of the synagogues became spatially more complex, because of the division of the internal volume into height vaulted structures, supported by columns (fig. 3) [3].



Fig. 3. The Synagogues in Kurkliai and Alanta (built in 19th-century)

Among the other confessions there is also the Islamic faith, that spread in Lithuania between the XIV-XV centuries. Only three wooden mosques remain, all of them located in the south-east area of the Country. The buildings are from the outside similar to the Catholic churches, presenting a rectangular plan with a small tower – minaret.

All these religious buildings compose a rich and complex compendium of architectural traditional elements, of which the Catholic churches are the oldest. Over the centuries various religious denominations have developed differences in their wooden architecture spatilities, shaped by the specific rituals that took place in them. Nonetheless, they shared similar structural and technical solutions, based on the possibilities offered by wood and its derivatives, also founded – however – on different functional-planimetric needs, or diversified symbolic-spatial and figurative-aesthetic instances.

For the construction of wooden buildings in Lithuania all local natural resources were used: various wooden species (that ones ordinarily used for building construction), compact stone for foundations, clay and brick, lime mortar, dried moss for building insulation, straw and wooden shingle for roof cladding. Some

sacred architectural and structural differences were resulted by different religions and cultures. Also each region presents some specific architectural features, which are often associated with different choices of constructive materials and decorative elements.

2. CONSTRUCTION TECHNIQUES

2.1. Foundations

The majority of the Lithuanian old single-family houses were built directly on the ground, without any groundwork. In some cases oak or conifer logs, partially planted in the ground, were used for the foundations, positioned at the corner and at the center portions of the building, in order to isolate or elevate the wooden walls. During the evolution of the construction techniques the foundations supporting wooden structures were built using large and compact blocks of stone, or realizing a stratum of smaller dry stones [1].

2.2. Load-bearing wooden walls

Most of the wooden Lithuanian churches were built using the so called *Blockbau* system, while for the construction of bell towers was used the framework constructive system. Wooden Lithuanian churches were characterized by an extreme constructive simplicity and for wooden vertical structures were used not perfectly squared logs, having often a circular cross-section. The logs have been carved with small grooves on the top and on the bottom nearby the corners of the log and they were connected together by a partial or total overlaps at the corners of the building (fig. 4a, 4b). Each log was connected to the lower one by wooden nails. Using the drill some holes were made in the logs where, subsequently, long wooden nails have been inserted to support the wall and-at the same time – even the whole wooden structure (fig. 4e). Small grooves also were made all along the log – on its' lower part – in order to avoid rain damages. This system can be eas-

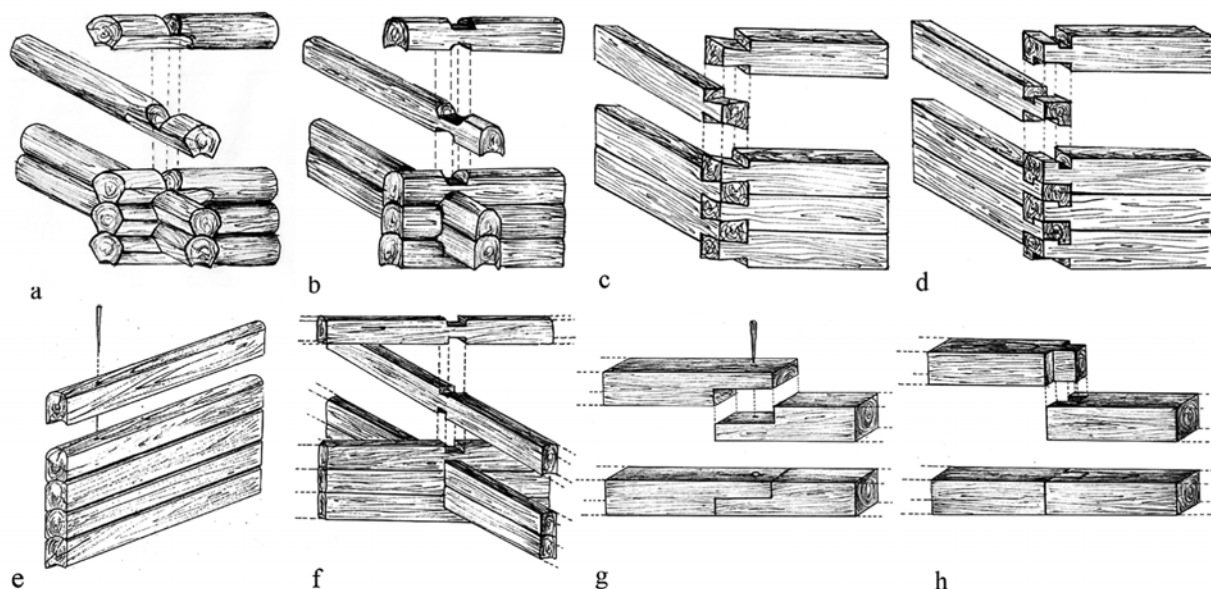

Fig. 4. a-d) *Blockbau* constructive system; e) log connected to the lower one by wooden nails; f) timber walls intersection; g), h) log connections (designed by L. Berežanskytė)

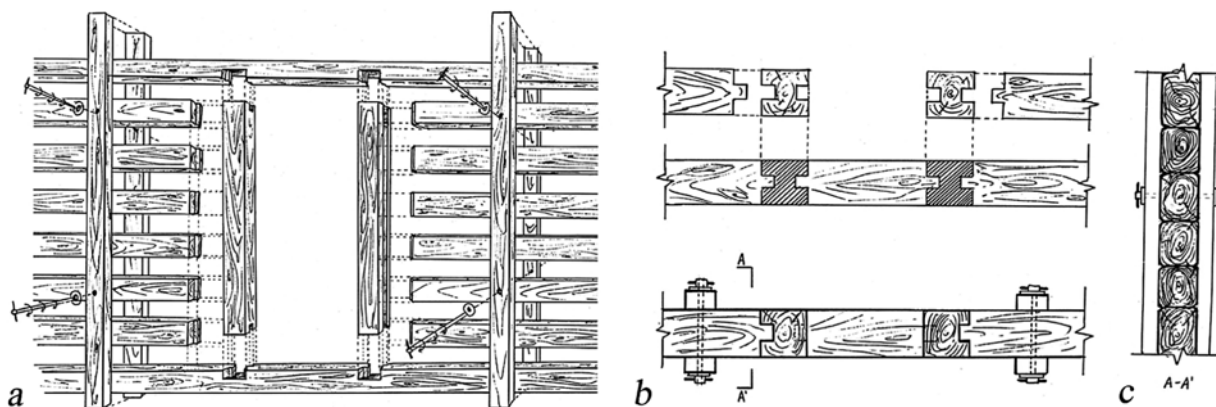

Fig. 5. Secondary structure composed of pillars placed on the internal and external walls of the church, in order to reinforce and stiffen the perimeter walls (designed by L. Berežanskytė)

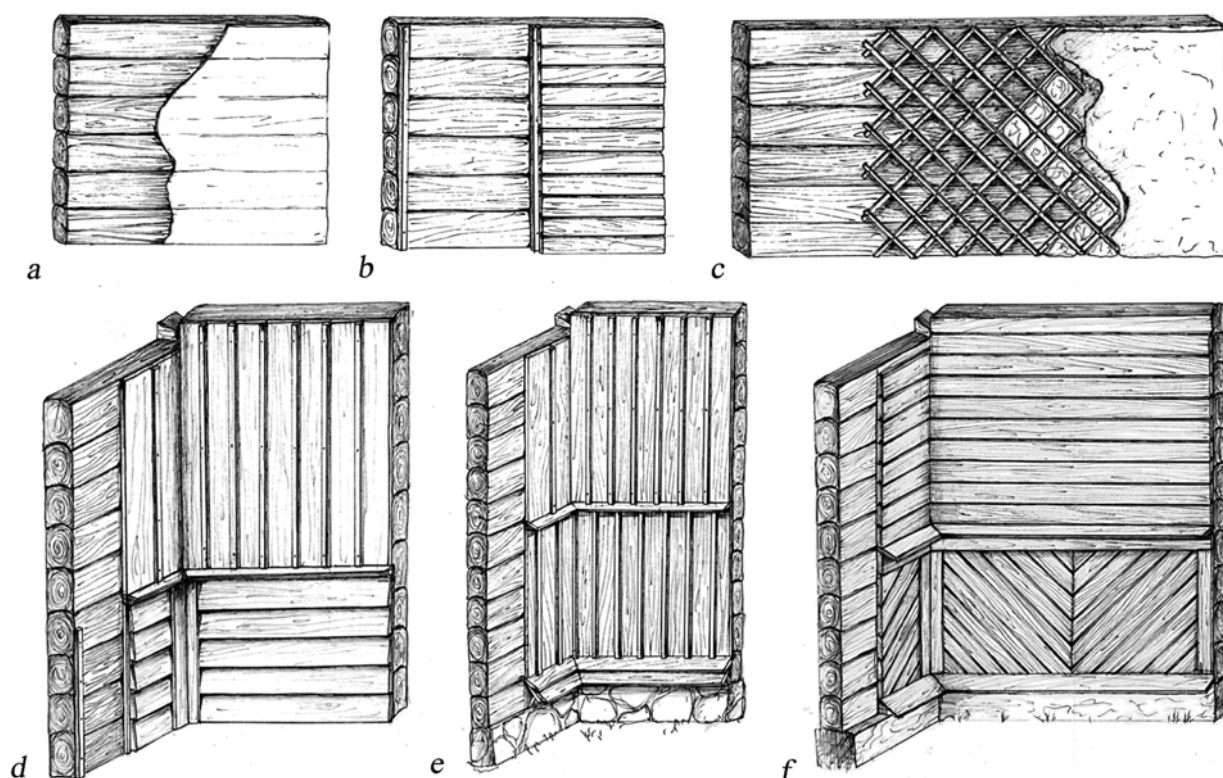

Fig. 6. Internal (a-d) and external (e,f) wooden wall cladding (designed by L. Berežanskytė)

ily recognized in the corners of the building exterior walls, where the supporting structure is clearly visible.

The usage of clay guaranteed from the possibility that water and air could pass through the connections and it improves the contact between the same logs. Frequently moss has also been used as a sealant. In the northern Lithuanian areas the use of moss was preferred, while in the southern areas more often clay was used, determining the wall-insulation differences [1].

Subsequently, with the development of new and more specific tools, carpenters began to cut the logs with a square section; in this case, the construction of perimeter walls, following the *Blockbau* system type, could reach a complete and perfect cohesion and result. Nowadays, we can find just few types of wooden walls realized using a rectangular section (fig. 4c, 4d).

The same principle was adopted for the realization of internal walls by making rectangular recesses at the bottom and the top of the trunk (fig. 4f).

In order to increase the walls linear dimension carpenters found a way to join the extremities of the logs as – until then – the maximum longitudinal dimension of churches was dependant on the linear dimension of the single log. Logs were connected with great precision to prevent the penetration of moisture and rainwater: as a result of a secondary processing, the ends of the logs were well-shaped and adjusted to facilitate the joints (fig. 4g, h). The connection points were staggered from line to line of logs, in order to avoid the weakening of the wooden wall.

Furthermore, a secondary structure, composed of wooden pillars placed on the internal or external walls of

the church, was realized, in order to reinforce and stiffen the perimeter walls. Together with the *Blockbau* system, earlier mentioned, these pillars were connected by metal bars fixed at the ends through bolted connections (fig. 5).

2.3. Internal and external walls cladding

Usually, the interior walls of the churches appear without any cladding, with the *Blockbau* system well-visible; only sometimes it's possible to find an internal timber cladding, directly nailed in various directions to the wooden wall. In some cases, wooden internal walls could be covered instead with a simple clay mixture, or with a lime mortar plaster. The clay mixture was applied on the interlacement of wooden slats, placed in a diagonal direction. Another type of covering is a coat of paint, directly applied to the wooden wall (fig. 6a-6c).

External walls cladding have a double function: to protect the wall from humidity and to guarantee a better lifetime to timber structure, as well as to provide a decorative finishing. That's the main reason why the façades present different decorative and ornamental technical choices.

The wooden planks, mounted in various directions, divide the vertical surfaces in frames and compartments, creating ridges conformations of the surfaces, useful for the disposal of rainwater or positioned in order to cover up the connection points between the large beams of walls.

Façade cladding is often divided into two recognizable zones: one located near the basement area, where the planks could be easily harmed by the damp and

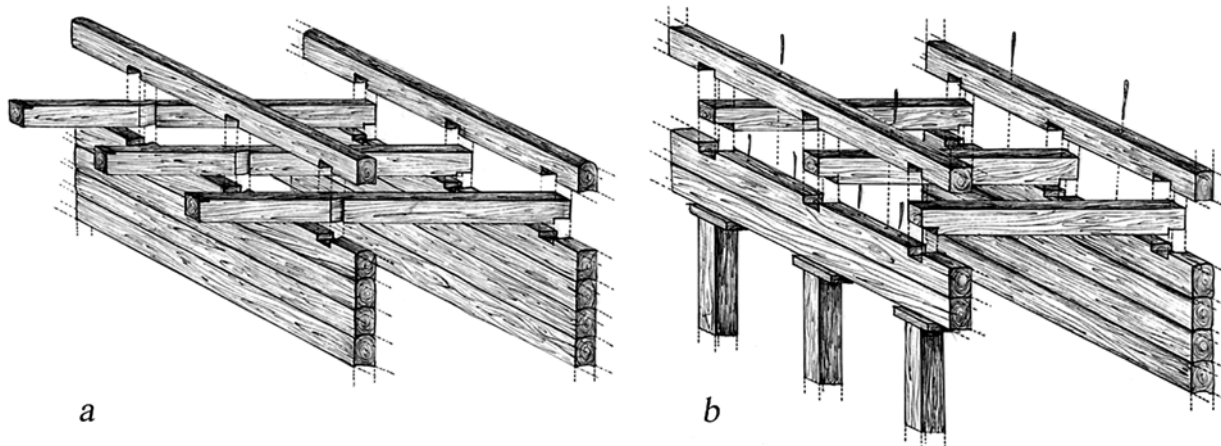

Fig. 7. Construction techniques of interior balconies (designed by L. Berežanskytė)

water, and another part located instead at the top, which was less affected by damp.

Every religious building had a different construction and assembly type of planks; in the most common cases we notice the use of timber planks, nailed in vertical and diagonal directions, also with a herringbone and squared elements (fig. 6d-f).

In the *Blockbau* system, if the construction wall was smooth and without any bumps and deformations, the wooden planks were nailed directly to the wall. But if the wall had bumps and deformations, therefore the planks were nailed in a horizontal way, in order to make smoother the surface and to give more space for the coating elements of.

2.4. Internal balconies

The internal balconies are a constructive element always present in Lithuanian churches; they are designed from the beginning of the church construction and have a double function: to allocate upside the pipe organ and to constitute an useful space for the singers.

The internal balconies are also useful also to divide the churches space into a main entrance and an ecclesiastical hall.

There are two different ways to build the internal balconies: the first one was adopted when the beams of internal balconies lay on the perimeter and on the inner walls (fig. 7a). The second one was realized when the beams rest on external wooden walls and on internal pillars or columns (fig. 7b). Over the beams of the balcony main structure, the wooden planks are nailed, creating an available attic space. Then, a railing located along the edge of the balcony was constructed; usually it was full-empty or discontinuous, as a balustrade.

The handrail of the railing was made with a semi-circular trunk and its lower part was connected to the balusters with a mortise-tenon connections or nailed, if it's necessary.

2.5. Roof structure: trusses

The slopes and proportions of the Lithuanian roofs were inspired and modeled by climatic conditions, such

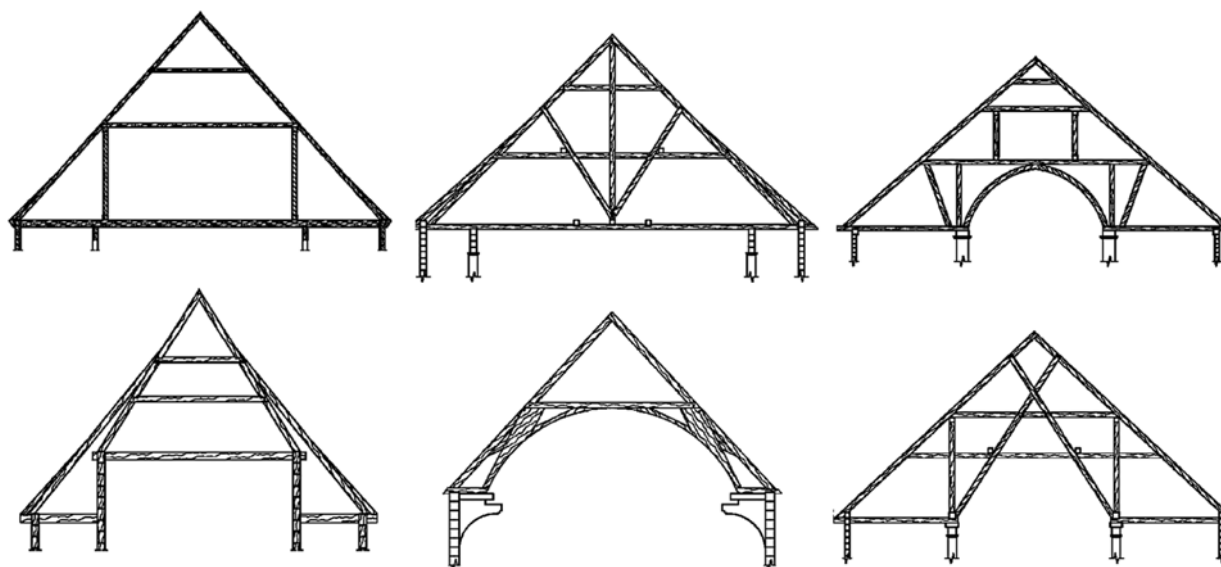

Fig. 8. Types of timber roof trusses

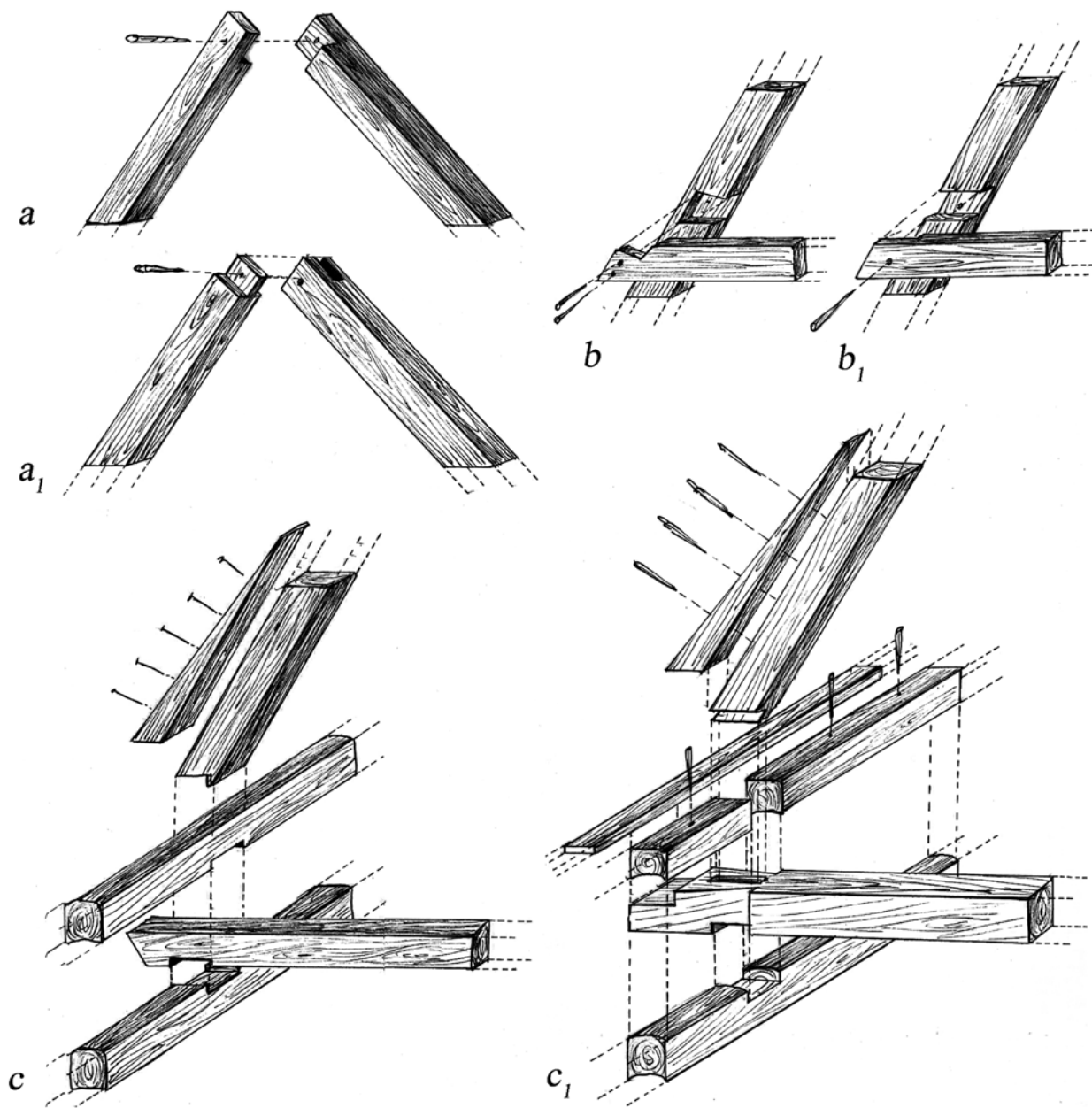

Fig. 9. Technological analysis of the truss; special structural nodes a1 – “rafter-rafter” connection, b1 – “collar tie-rafter” connection, c1 – “rafter-ceiling joist” connection (designed by L. Berežanskytė)

as the high levels of precipitations and the awareness to built in a geographical area having a high risk of snow and rain. We observe a great attention to protect buildings from damage provoked by weather conditions. The large quantity of snow, accumulated on the roofs during winter, produced substantial overloads on wooden structures. This is the reason why carpenters realized trusses very close one to each other, placed them at a short step of about 1,30–1,50 mt.

The main structure consists in some rafters and trusses, also in this case denoting a great variety of shapes and technological choices (fig. 8). Over the time wooden roofs have suffered a lot of changes: the evolution of structural systems has improved geometries and structural systems. In particular, trusses have evolved in

their wooden connections as the “rafter-rafter” connection (fig. 9a₁), “collar tie-rafter” connection (fig. 9b₁), “rafter-ceiling joist” connection (fig. 9c₁). In the early wooden buildings they were made by a combination of elements, connected by means of wooden pins and nails, then gradually were adopted instead metal rivets (metal screws).

The same constructive wisdom was used in the realization of the church towers, that complete the volumetry of the religious building: these towers were incorporated into the roof structure, they rose up in the architecture of the main façade, and had a framework wooden structure in which, over the centuries, were added more structural elements, useful to strengthen the original structure.

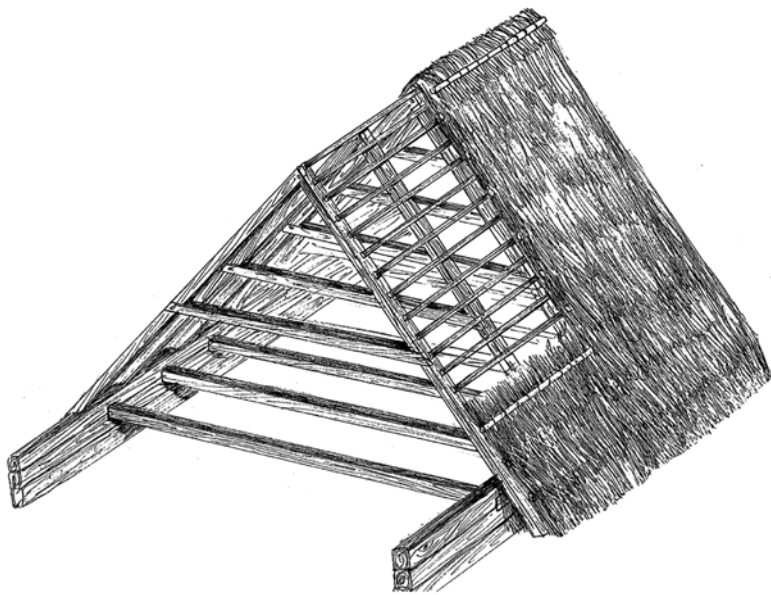

Fig. 10. Roof structure covered with a mantle of wheat sheafs; in the picture above: roof cladding using wooden shingles, in the picture below: metal sheets cladding

2.6. Roof coverings, consolidations and reinforcements

The roof structure was completed when the timber strips was nailed over the realized trusses in a perpendicular direction and placed close together in a way to ensure the sufficient support and fixing of the external covering. The roof coverings differed from nailed wooden little planks, wooden shingles to wheat sheafs. Lithuania was been – and partly is still today – a country mainly based on agriculture: this is the reason because the ancient roofs were covered with a mantle of wheat sheafs, in order to use as better as possible the local resources (fig. 10) [4].

The construction systems and the materials of coverings determined the different roof volume and shape, also guaranting the correct roof structure isolation and protection from the rain and snow.

During the years, the original sacral building coverings were subsequently replaced with slate sheets or metal shingles. Today it is possible to recognize and identify the original elements of the ancient structures from a multitude parts added and /or later replaced. The church exterior decorations have the function of concealing the structure reinforcing elements. These reinforcing elements are clearly visible in correspondance of the attic. The structure of the roof shows the various strengthening interventions made during the life of the building.

Starting by the end of the nineteenth century we can find the employ of a bitumen layer, placed under the roof covering. During the eighteenth and nineteenth centuries churches roofs did not have gutters, and rain was dripping off freely; so the builders protected the ground surface of perimetral wooden walls by a metal sheet. Metal drainpipes were adopted only during the late nineteenth century.

2.7. Ceilings

The wooden ceilings have a great variety of shapes and constructive technics, because they represent one of the main elements that identify and characterize the interior church volume. Usually, they present a rectilinear, vaulted or polygonal conformation. When the building has more than one nave, ceilings were realized at different heights and with different conformations: usually, the ceiling of the central nave have a major height than that of the lateral ones.

The church ceiling was also set at a not too high height, in order to heat the interior environment more easily during the winter. The empty space between the ceiling and the roof structure was working as a thermal and acoustic insulation. The construction technique is based on the variety of types and shapes. The horizontal (or pseudo-horizontal) ceilings are made nailing the wooden boards directly on the top, on the bottom or on the both sides of tie beam (fig. 11b, 11c). A linen tow layer has been realized on the wooden ceiling as a thermal insulator, due to guarrantee a warm attic also in the winter time. Often the ceiling is relized with the timber boards nailed on the both sides of tie beam and between these two layers is insert the linen tow layer: in this way the ceiling extrados becomes an usable attic (fig. 11a).

The barrel-vaulted ceilings follow the same construction technique of flat ceilings; the shape of wooden arches that consitute tha main structure of ceiling defines the barrel-vaulted form, and then the secondary structure of close slats was nailed on their lower surface.

2.8. Pavings

Among Lithuanian wooden sacral buildings we found very few examples of pavings. The beams of paving are placed above the foundation (compact stones, or

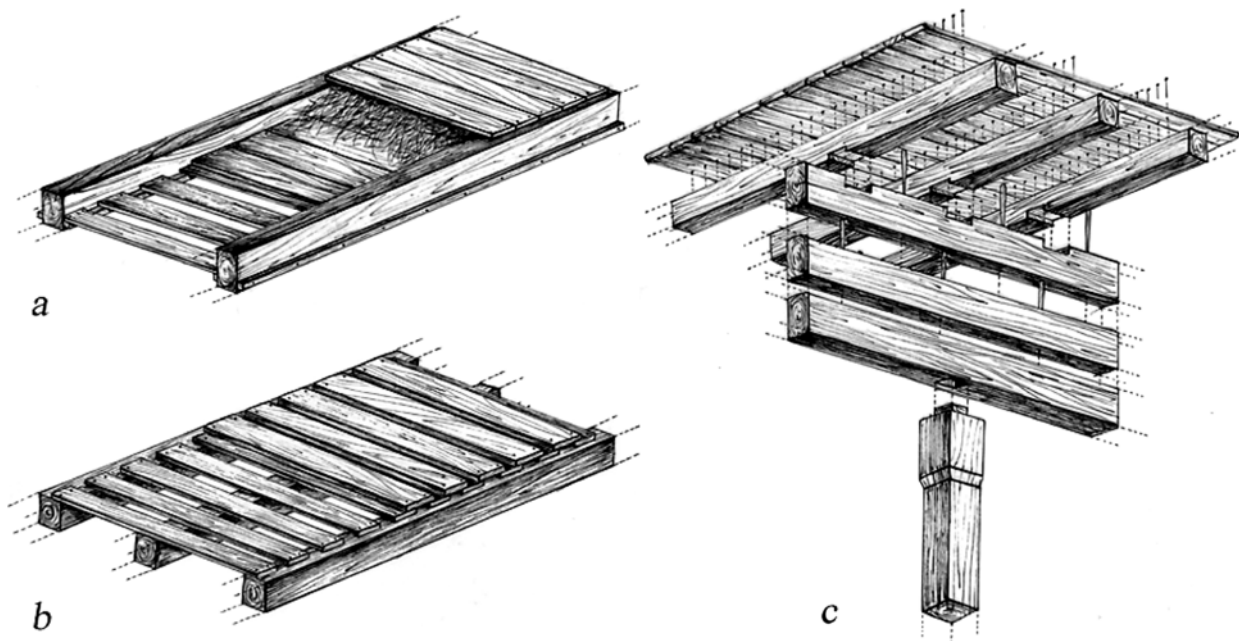

Fig. 11. Examples of interior wooden ceilings (designed by L. Berežanskyté)

oak trunks – burned to prevent soil humidity), inserted into the ground, until the clay level. On this level is placed a gravel stratum, which may constitute a crawl space useful to eliminate humidity. The space between beams and gravel was filled up by linen tow. Finally, the wooden floor was constructed on these beams in an opposite direction (fig. 12a).

The other flooring type is composed by resistant oak logs, cut into various sections and inserted directly into the ground, each one close next to the other one (fig. 12b).

2.9. Openings

The realization of the openings is made by the implementation of doorjamb liners, made using logs vertically placed and realized with a rectangular groove throughout the entire length of the log and also tied

to the horizontal logs. They are well conformed, with adequate nodes to ensure the doorjamb attachment to the wooden perimetric walls of *Blockbau* system.

The opening lintel was directly constituted by the log forming the upper structure of the perimetric wooden wall, instead the windowsill is derived from the lower trunk of the same perimetric wall. On thus obtained opening space was installed the window frame, having his opening system (fig. 13).

2.10. The bell towers: types, materials and constructive systems

The Lithuanian wooden bell towers were built in the fifteenth century, after the construction of the first churches. Bell towers were built inside the church enclosure. In some cases, however, the wooden belfries are older than the churches. Churches have been restored or

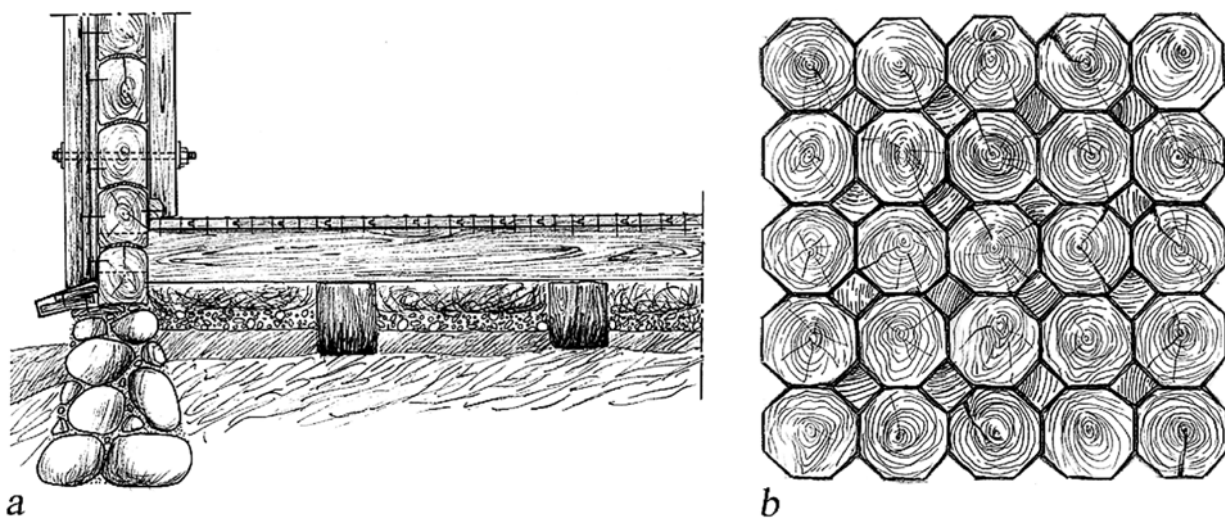

Fig. 12. Flooring types; a – section of paving construction, made of the wooden boards, b – flooring made of sectioned logs (designed by L. Berežanskyté)

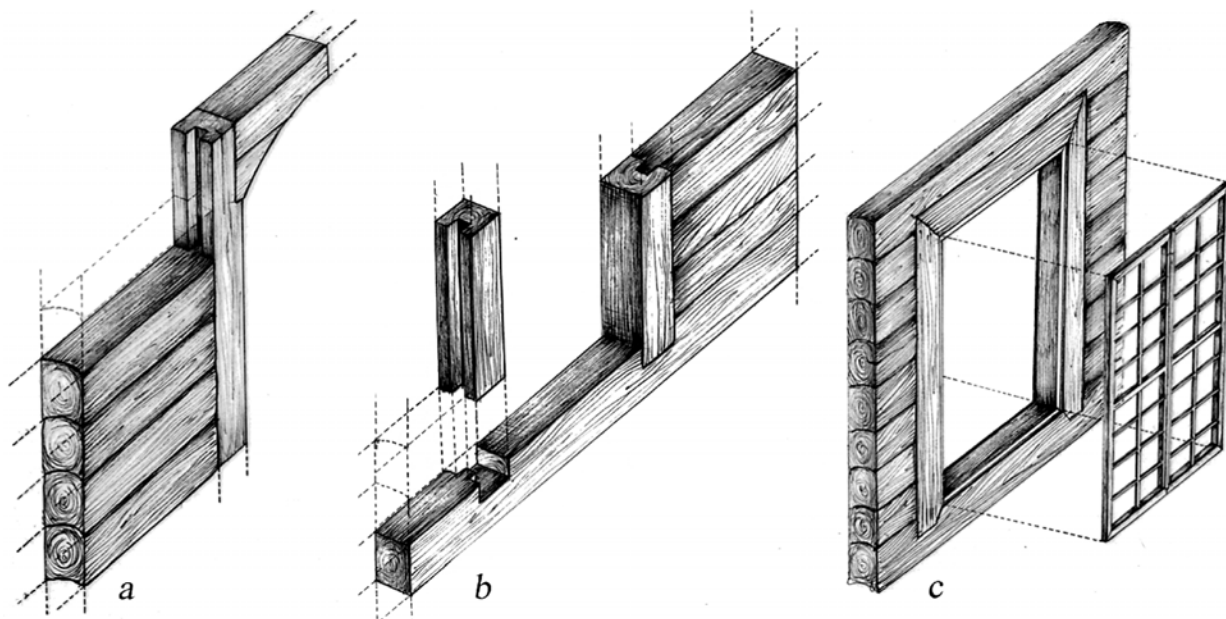

Fig. 13. Opening construction system (designed by L. Berežanskyté)

re-built over time, while bell towers almost never were subjected to such works. Both, wooden churches with towers, and those without, have belfries to preserve the

structure of the church from the huge weight of the bell and the dynamic loads that could damage the construction of towers [2].

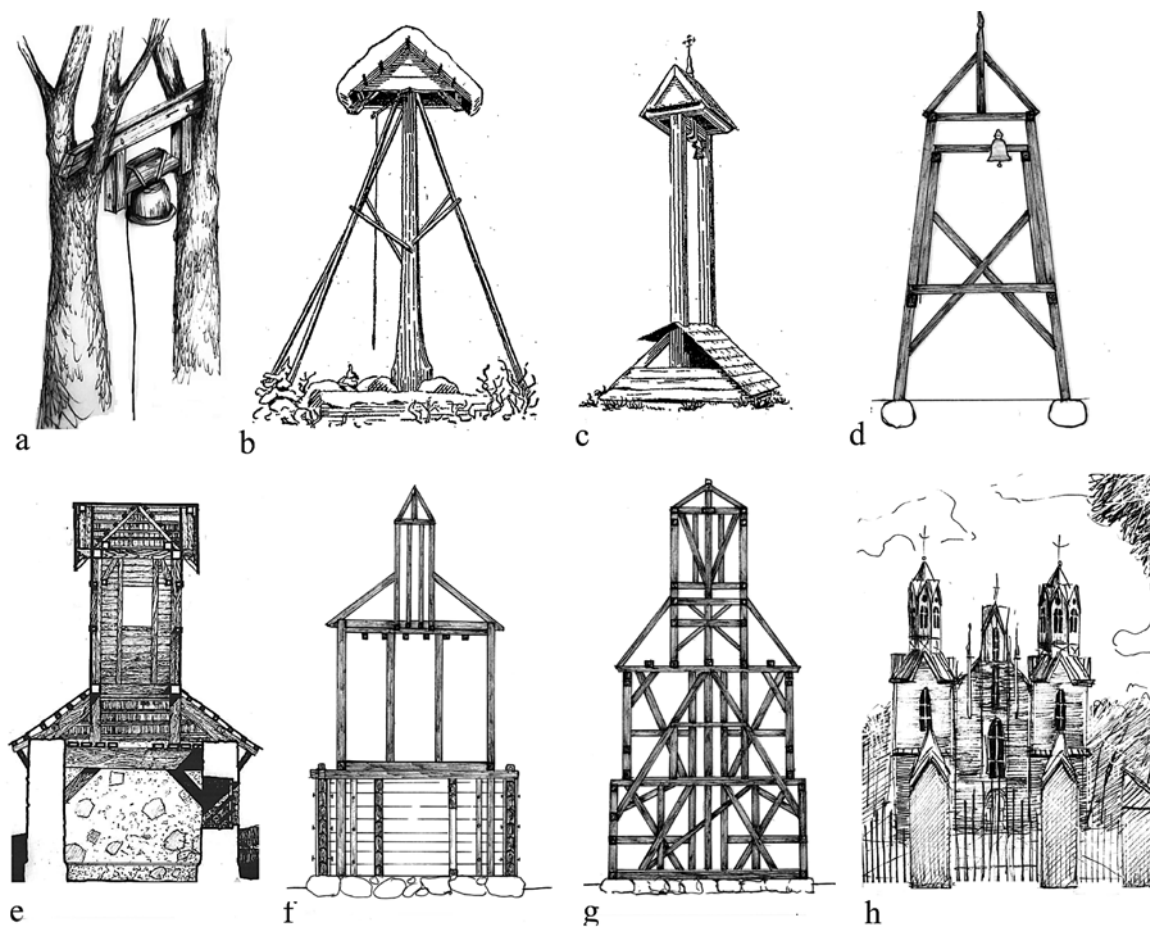

Fig. 14. Types of bell towers: a) bell, hanging between two trees; b) bell tower realized with wooden oblique or crossed planks; c) belfry, made by two trunks fixed to the ground; d) bell tower made with four logs joined together by a frame trellises; e) bell tower built on masonry ground works, adopting the frame system; f) belfry made mixing different systems (Blockbau and frame system); g) tower realized with small roofs with intermediate connections; h) belfry, incorporated into the church (Some sketches are taken from Kauno Technologijos Universitetas archives)

Bells were installed in belfries to reinforce the sound to be heard from afar, and also to protect metal bells from atmospheric agents. The so called *cemeterian* type of bell towers is the most simple and primitive. Sometimes nearby the churches the bell was mounted on a crossbar, hanging between two trees (fig. 14a). At first bells were small and light, they were raised and hung on a long tree trunk, embedded in the ground and connected in a radial way with four sticks. These timber sticks were sometimes strengthened with wooden oblique or crossed planks. On the top of this structure was built a small roof, covered with wooden boards (fig. 14b). There was another more complex type of primitive belfries: the belfry was made by two trunks fixed to the ground and joined at the top by a small roof. To make this structure more stable in the lower part wooden structure was mounted further with a second small covering (fig. 14c) [5].

Over the time, bells became larger and heavier and therefore it was necessary to construct more resistant supporting structures, which could also inhibit strangers from the improper use. New bell towers had a squared plan, with four logs at the corners fixed to the ground or raised on stones or bricks, wall panels joined together by a frame trellises made with wooden boards put in place with various geometric configurations. The outer covering of wooden trellis included the installation of boards placed vertically, and the whole structure generated a volume tapered towards the top (fig. 14d) [2].

This kind of belfry has evolved in time in very different ways: with square, hexagonal, octagonal plans, adopting increasingly a complex constructive methods comparable to those used for the construction of the towers placed inside the churches, and visible on façades. In the beginning of the eighteenth century towers were often built on masonry ground

works, adopting the *Blockbau* system (fig. 14e). Other types of belfries were made mixing different systems: *Blockbau* system at the basement, a structural frame in the remaining part of the erecting structure (fig. 8f).

Bell towers with an unique and compact volumes had a complex building system, adopting internal oblique connections between the opposite walls, made to clampe and shackle structural walls which were not very thick. In those types of bell towers where external volumes varied considerably in width, tapering from the base upward, small roofs with intermediate connections were created, in order to protect lower floors from the rain (fig. 14g) [2]. Towers built since the eighteenth century were mostly incorporated into the churches, and represent façade elements, so that slowly the isolated belfries began to decrease (fig. 14h) [1].

3. CONCLUSIONS

Since the 19th century all the Europe witnessed a general decline of the arts and techniques, related to wooden buildings and for a long time no new wooden buildings were made [2]. Architects are no longer able to correctly identify the shapes of the sacred architecture, and this leads to numerous mistakes during the restoration and reconstruction phases [7].

In order to preserve this architectural heritage, that witnesses the development of our culture and history, we hope for restorations particularly careful in the use of traditional materials while limiting the use of incongruous materials, as well as the uncultivated tamperings, demolitions and replacements.

This research can give a detailed analysis and knowledge of the wooden buildings, associated to useful guidelines for technicians and workers that operate in recovery and maintenance intervention.

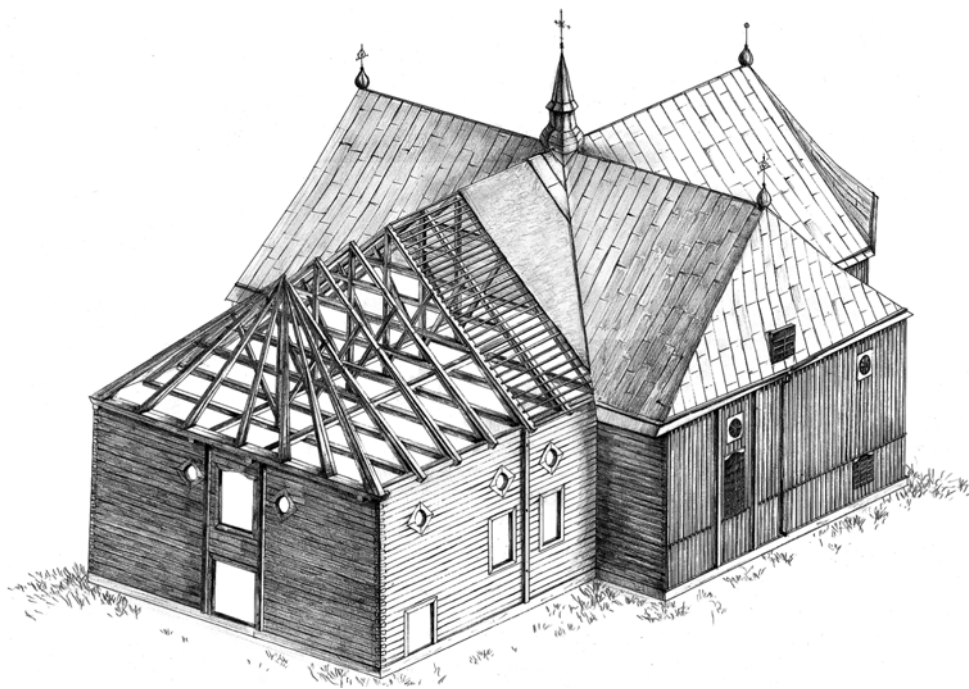

Fig. 15. Axonometric view of the church (designed by L. Berežanský)

We hope that this research can be traced an operational tool and an impulse to improve and implement the knowledge of this unique building heritage, even in its simplicity, but rich in history and established building traditions, that we have to preserve by negligence and uncultivated interventions.

REFERENCES

- [1] Bertašiūtė R. Forma ir konstrukcija lietuvių sodybos medinių trobesių architektūroje. Dr. disertacija. Kaunas, 2002.
- [2] Jankevičienė A. Lietuvos medinės bažnyčios, koplyčios ir varpinės. VDA leidykla, Vilnius, 2007.
- [3] Rupeikienė M. Nykstantis kultūros paveldas: Lietuvos sinagogų architektūra. E. Karpavičiaus leidykla.
- [4] Detlefzenas R. Rytų Prūsijos kaimo namai ir medinės bažnyčios. Vilnius, 1995, 77.
- [5] Galaunė P. Lietuvių liaudies menas. Vilnius „Mokslas“ 1988: 89-100.
- [6] Gimbutas J. Varpinė. Lietuvių enciklopedija. T. 33. Boston, 1965, 181-185.
- [7] Bolotskih N., Klimov I. Rescuing the Hidden European Wooden Churches Heritage, Italy supported by “Culture 2000” of the European Community. Florence, 2006.

Abstract

Lithuania is situated in a highly forested North-eastern Europe area and has a great variety of wooden buildings. Among the wooden structures we can enumerate the religious buildings, rich of historic values, presenting different shapes and sizes and also a complex design and stratified construction phases. The oldest wooden churches began to built in Lithuania in the 13th century. Currently, there are more than 600 existing wooden sacral buildings, which not yet have detailed studies about their constructive and structural aspects.

The main objectives of the research are:

- knowledge of the rituals, related to the building types and stylistics and architectural solutions which were adapted to the Lithuanian sacred architecture;
- systematization of the all sacred Lithuanian wooden buildings, with a particular attention to a detailed study of the more significant examples;
- systematization of the building types and design of a constructive techniques catalogue, useful to the future recovery and preservation of timber structures;
- schedules of the technological solutions, implementation of analyzed wooden buildings, related to the damage mechanisms and detected failures;
- architectural and constructive terms glossary (Italian-Lithuanian-English languages).

The research project proceeds – according to the direct knowledge of the building and through the analysis of the actual conditions – to define a geometric – dimensional and constructive survey, the analysis of the constitutive geometries, the history of construction techniques, the analysis of the main failures and degradations, the retrieval of the literature of the churches and their construction techniques.

Streszczenie

Litwa położona jest na gęsto zalesionych terenach Europy Północno-Wschodniej, stąd bogactwo budownictwa drewnianego w tym kraju. Wśród budynków drewnianych wyróżniają się obiekty sakralne, o dużej wartości historycznej, różnorodnej formie i rozmiarach, złożonych projektach i wieloetapowej realizacji. Najstarsze kościoły drewniane zaczęto budować na Litwie w XIII wieku. Obecnie na terenie kraju znajduje się ponad 600 drewnianych obiektów sakralnych, których aspekty konstrukcyjne i strukturalne nie zostały jeszcze szczegółowo zbadane.

Główne cele przedstawionych badań to:

- poznanie tradycji i rytuałów związanych z typami budynków oraz rozwiązań stylistycznych i architektonicznych wykorzystywanych przy wznoszeniu obiektów sakralnych na Litwie;
- usystematyzowanie wszystkich drewnianych obiektów sakralnych na Litwie oraz szczegółowe badania najważniejszych przykładów;
- usystematyzowanie typów budynków oraz opracowanie katalogu technik budowlanych, przydatnego w przyszłych pracach konserwatorskich i rekonstrukcyjnych obiektów drewnianych;
- rozwój i zmiany w stosowanych rozwiązaniach technologicznych, zachodzące na przestrzeni wieków, analiza obiektów drewnianych pod kątem mechanizmów zniszczenia i zidentyfikowanych uszkodzeń;
- opracowanie słownika zwrotów architektonicznych i konstrukcyjnych (w językach włoskim, litewskim i angielskim).

W ramach projektu przeprowadzono analizę obiektów pod kątem ich geometrii, wymiarów, konstrukcji, geometrii elementów składowych, historii technik budowlanych, głównych uszkodzeń i degradacji drewna – na podstawie badań obiektów i ich rzeczywistych warunków, a także na podstawie znalezionej i zgromadzonej dokumentacji dotyczącej kościołów i technik zastosowanych do ich budowy.