

STRUCTURAL OPTIMIZATION ON THE DESIGN OF AN AUTOMOBILE ENGINE INTAKE PIPE¹

JIANXIN XIE, ZIMENG LIU

College of Intelligent Manufacturing, Qingdao Huanghai University, Qingdao, China

Corresponding author Jianxin Xie, email: jasonxjx@126.com

The engine intake pipe is an important part of the engine. A reasonable layout of the intake pipe can prolong service life of the engine and improve engine power. The optimization of design of the intake pipe has a great impact on the overall performance of the engine. The design of the intake pipe based on experience is subjective and unilateral, and the design cycle and experimental period are long. Ansys Fluent software is used to simulate the design, which can more intuitively reflect the air flow condition of the intake pipe and enable selection of the best layout. First of all, a three-dimensional model of the intake pipe is simulated and the airflow characteristics are studied and analyzed. The streamline diagram and velocity contour under various conditions are obtained. Then, compared with the simulation results, the position of the intake pipe is optimized. Finally, the optimized intake pipe is simulated and verified. According to the experimental results, the intake performance of the optimized intake pipe is greatly improved.

Keywords: engine, intake pipe, Fluent, optimization design

1. Introduction

The engine intake pipe is an important part of the automobile intake system and the first channel to guide the air flow into the combustion chamber for mixed fuel transformation (Li, 2018; Gao *et al.*, 2017). Although the electronically controlled fuel injection engine simplifies the structure of the intake pipe to a certain extent and reduces design considerations, the structural design of its inner wall directly affects the flow law of the air flow and thus the amount of intake air (Zhang *et al.*, 2019; Yi *et al.*, 2018; Wahono *et al.*, 2019). When designing the intake pipe, in addition to considering the performance requirements of different engines, we should also pay attention to the economy and emission of the engine, and consider the atomization and evaporation effect of the fuel and fuel distribution. Therefore, the design of the engine intake pipe should be considered and coordinated in many aspects. According to the flow law of air in the intake pipe of the engine, measures are taken to improve the charging efficiency, improve the uniformity of intake air, and make the engine better matched with the intake pipe (Dhital *et al.*, 2019; Karthickeyan, 2019; Khoa and Lim, 2019).

This paper takes a 480 four cylinder in-line water-cooled diesel engine as the research object. The main parameters of the 480 diesel engine before transformation are shown in Table 1.

2. Establishment of intake pipe model

Although the structure of the engine intake pipe is simple, its bending degree is relatively complex. It is very easy to produce a non-standard surface after scanning, so it is impossible

¹Paper presented at the 5th International Conference on Material Strength and Applied Mechanics, MSAM 2022, Qingdao, Shandong, China

Table 1. 480 Diesel engine specifications

Cylinder bore stroke [mm×mm]	Displacement L	Rated power [kW]	Rated speed [r/min]	Maximum torque [N m]	Speed at max. torque [r/min]	\mathcal{A} [g/(kW h)]
80 × 107	3.68	51.8	2300	240.5	1700	152.1

\mathcal{A} – Minimum fuel consumption ratio of external characteristics

to standardize it, so it is not easy to adopt interactive modeling. In contrast, the advantages of parametric modeling are highlighted. Using the parametric modeling, firstly, this paper selects SolidWorks as the three-dimensional model modeling software, uses SolidWorks to establish parts, establishes a single intake pipe part through parameters and uses cooperation steps in SolidWorks to assemble the intake pipe arrangement for numerical simulation calculation and analysis.

The intake pipe model is divided into five parts:

- (1) The inlet of the engine intake pipe has a transverse width of 1000 mm and a height of 115 mm.
- (2) The engine intake pipe assembly is integrated into a round pipe with a radius of 60 mm in a flat circular shape, which is composed of two semi-circular arcs with a radius of 25 mm with a center distance of 160 mm at the inlet of the intake pipe.
- (3) The left end of the intake pipe and the connecting pipe of the air filter is a 120 mm square rounded with a quarter arc with a radius of 30 mm, and the right end is a regular circle with a radius of 60 mm.
- (4) The placement box of the engine air filter is 600 mm long, 200 mm wide and 300 mm high.
- (5) The engine intake pipe, intake manifold connecting pipe and pure circular pipe have a radius of 55 mm.

The specific model is shown in Fig. 1.

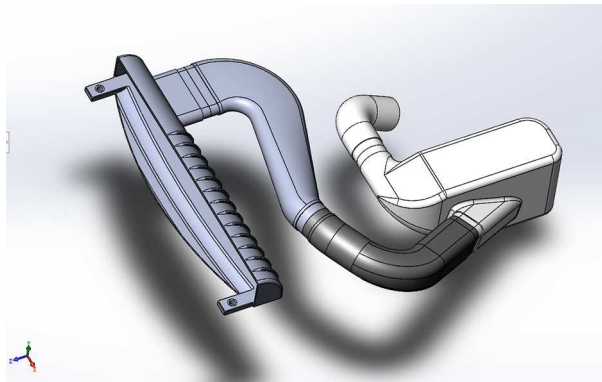

Fig. 1. Assembly of the engine intake pipe

3. Parameter setting of Fluent intake simulation

The grid division of the engine intake pipe is an important step in numerical simulation of the intake state of the engine intake pipe. The detail of the grid division will directly affect the accuracy of numerical simulation. Therefore, the important positions of the intake pipe should be divided in detail in order to obtain more accurate simulation data. As shown in Fig. 2, it is the grid division diagram of the fluid control domain of the intake pipe.

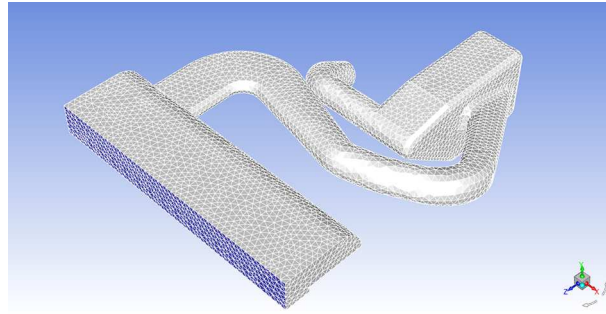

Fig. 2. Grid division of the intake pipe fluid control domain

After the grid division of the fluid control domain of the intake pipe, according to various solution methods of numerical simulation of gas flow in the fluid control domain in the second Section of this paper, the Fluent module in Ansys software is used for numerical simulation of the air flow, and the flow state in the intake pipe is obtained.

For simulation analysis of the intake pipe, the control area of gas flow should be selected first, and the circulation medium should be selected as well. Generally, the main gas flowing in the intake pipe is the air, so various parameters of the air should be set during the simulation (Xu *et al.*, 2021; Yan *et al.*, 2020). The internal model is set as $k-\varepsilon$ (2 eqn), and the gravity acceleration is 9.8 m/s^2 in the negative direction of Y axis. When idling, the negative pressure of the single intake manifold is 64-71 kPa, then the negative pressure of the general intake manifold is about 128-142 kPa under normal idle state of the engine. With a change of the pipe radius, the vacuum degree in the intake pipe is also changing. Therefore, the value of vacuum degree does not have a significance of full reference. In order to better study air flow characteristics, a method of amplifying the negative pressure is used to more obviously reflect the flow state of the air flow (Shi *et al.*, 2020). When simulating the intake of the intake pipe, the vacuum degree (i.e. boundary parameter) of the intake pipe is taken as 135 kPa. The air flowing in the intake pipe is generally the air under normal pressure, and the temperature is set to 20°C . Given the value at 20°C in Table 2, physical parameters of gas at 20°C are assumed.

After setting various parameters in Fluent, the inlet speed and outlet pressure of the gas flow in the intake pipe are selected to simulate the air convection speed under different vehicle speeds and the air flow state under negative pressure in the intake pipe. The simulation interface and working environment of the intake pipe are shown in Fig. 3.

4. Simulation analysis of the intake pipe

The rated speed of diesel four cylinder engine is maintained at about 2300 r/min. During the calculation, the air density is set as 1.15 kg/m^3 , the inlet and outlet pressure are used as the inlet and outlet boundary conditions, and the wall surface of the intake manifold adopts the non-slip boundary conditions. Assuming that the gas flow in the intake system of the explosion-proof diesel engine is a steady turbulent flow of an incompressible viscous fluid, the $k-\varepsilon$ turbulence model can be used as the flow model. The boundary conditions are shown in Table 3.

4.1. Velocity contour analysis

Based on the perfect creation of a three-dimensional model, accurate meshing of the fluid control domain, accurate setting of the fluid domain boundary value and correct fluid physical parameters, numerical simulation of the fluid control domain is carried out with the help of Fluent module of Ansys software according to the calculation method given in Section 2 (Zhuang

Table 2. Air physical property parameters

Temperature t [°C]	Density ρ [kg/m ³]	Thermal conductivity λ [W/(m k)]	Specific heat capacity c_p [kJ/kg k]	Thermal diffus. coefficient α [$\mu\text{m}^2/\text{s}$]	Viscosity μ [$\mu\text{Pa}\cdot\text{s}$]	Kinematic viscosity ν [$\mu\text{m}^2/\text{s}$]	Planck number Pr [-]
-50	1.584	204	1.013	12.7	14.6	9.23	0.728
-40	1.515	212	1.013	13.8	15.2	10.04	0.728
-30	1.453	220	1.013	14.9	15.7	10.80	0.723
-20	1.395	228	1.009	16.2	16.2	11.61	0.716
-10	1.342	236	1.009	17.4	16.7	12.43	0.712
0	1.293	244	1.005	18.8	17.2	13.28	0.707
10	1.247	251	1.005	20.0	17.6	14.16	0.705
20	1.205	259	1.005	21.4	18.1	15.06	0.703
30	1.165	267	1.005	22.9	18.6	16.00	0.701
40	1.128	276	1.005	24.3	19.1	16.96	0.699
50	1.093	283	1.005	25.7	19.6	17.95	0.698
60	1.060	290	1.005	27.2	20.1	18.97	0.696
70	1.029	296	1.009	28.6	20.6	20.02	0.694
80	1.000	305	1.009	30.2	21.1	21.09	0.692
90	0.972	313	1.009	31.9	21.5	22.10	0.690
100	0.946	321	1.009	33.6	21.9	23.13	0.688
120	0.898	334	1.009	36.8	22.8	25.45	0.686
140	0.854	349	1.013	40.3	23.7	27.80	0.684
160	0.815	364	1.017	43.9	24.5	30.09	0.682
180	0.779	378	1.022	47.5	25.3	32.49	0.681
200	0.746	393	1.026	51.4	26.0	34.85	0.680

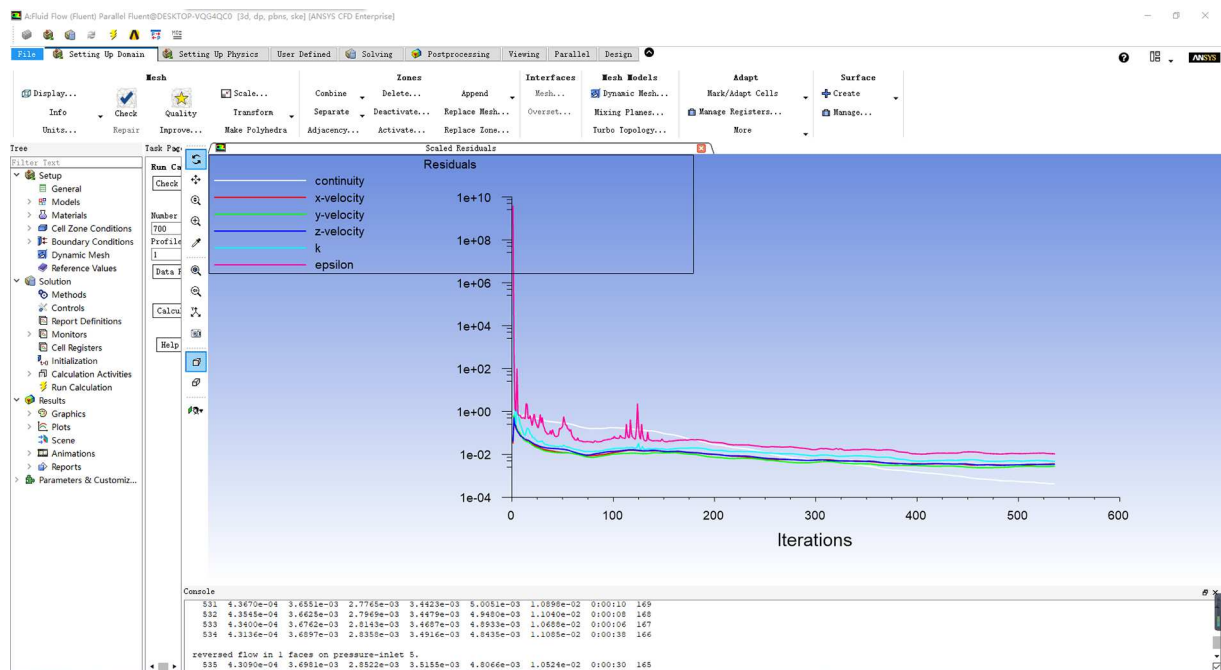

Fig. 3. Intake pipe simulation workbench

Table 3. Boundary conditions of parameters

Wall temperature [K]	Inlet pressure [kPa]	Outlet pressure [kPa]	Air density [kg/m ³]	Kinematic viscosity [m ² /s]	Speed [r/min]
320	95	93	1.15	$1.5 \cdot 10^{-5}$	2300

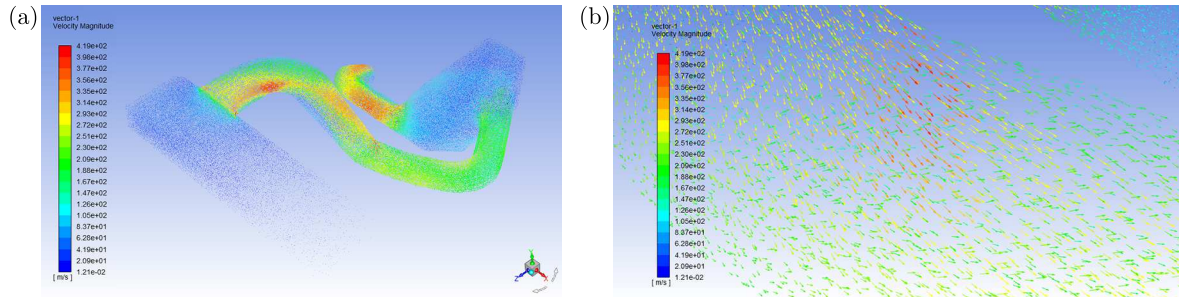

Fig. 4. (a) Velocity cloud diagram of the intake pipe assembly, (b) local velocity cloud diagram of the intake pipe

et al., 2020; Yin *et al.*, 2020; Zheng *et al.*, 2019). The velocity cloud diagram of the intake pipe is shown in Fig. 4a.

By observing the velocity cloud diagram obtained from numerical simulation of the intake pipe of the original engine, it can be seen that the maximum flow velocity 418.56 m/s and the minimum one is 0.01 m/s. The air flow at the inlet and outlet is 2.47 kg/s and -2.47 kg/s, respectively, which conforms to the law of mass conservation (Lin and Lv, 2019; Wang *et al.*, 2018). When the original engine intake pipe turns too sharp, it is easy to produce high-speed air flow, which intensifies friction and heat generation on the inner wall of the intake pipe, resulting in an intake loss. As shown in Fig. 4b, at the inlet of the engine intake pipe, the air flow velocity in the pipe caused by a rapid contraction of the pipe wall is accelerated, which is easy to produce intake turbulence, which is not conducive to improving the intake performance (Agiureev *et al.*, 2020; Mazzaro *et al.*, 2020).

4.2. Pressure cloud analysis

Under the cloud image option in Fluent of Ansys, the pressure cloud image of the intake air flow in the engine intake pipe, as shown in Fig. 5 is found and analyzed.

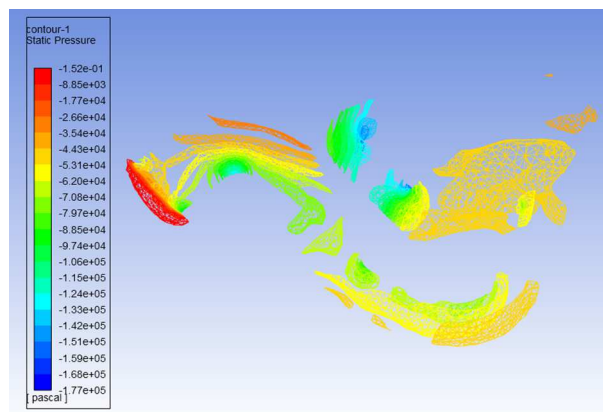

Fig. 5. Pressure cloud of the intake pipe

According to the observation in Fig. 5, the air flow pressure in the intake pipe changes with the bending degree of the pipe. At the bend, the pressure gradually increases from inside to outside, that is, the negative pressure gradually decreases. Compared with Fig. 4a, the position with a small negative pressure is the position with a small air flow rate. Because the negative pressure at the elbow changes greatly and the air flow state is complex, the greater the curvature is, the more unfavorable it is to the rapid flow of gas (Adithya *et al.*, 2020).

4.3. Turbulent flow energy analysis

Turbulent kinetic energy is a kind of flow potential energy generated by the swirling inertia of the air flow in the intake process of the intake pipe (Sun *et al.*, 2020). Turbulent kinetic energy is divided into turbulent component kinetic energy and total turbulent kinetic energy. The calculation formula for turbulent kinetic energy is usually

$$k = \frac{3}{2}(ul)^2 \quad (4.1)$$

where u is velocity, l – turbulence intensity.

In the engine combustion chamber, intake turbulence can increase the mixing degree of the combustible mixture, but in the intake pipe, larger intake turbulence is more likely to cause intake turbulence, which is not conducive to the rapid flow of the air in the intake pipe. Therefore, to analyze the intake turbulence, the intake turbulence cloud diagram shown in Fig. 6 should be analyzed.

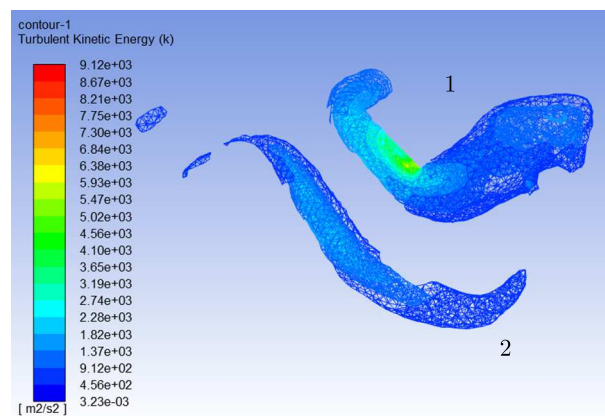

Fig. 6. Cloud diagram of inlet turbulence

Through the analysis of the turbulence cloud diagram in Fig. 6, it can be found that positions 1 and 2 in Fig. 6 are prone to inlet turbulence affecting the air flow. Improving the above components can enhance the intake response of the engine and is conducive to the rapid intake.

4.4. Analysis of a partial nephogram of the air inlet pipe

The local pressure cloud diagram at the inlet of the air filter housing of the engine intake pipe is shown in Fig. 7. Due to the complex geometric situation at the inlet, the intake pressure changes greatly due to the excessive bending angle, excessive fillet and lack of necessary air flow guidance support. Close to the inner wall of the shell, the air directly flows into the plane, and commutation is not timely. It is not conducive to the rapid air intake.

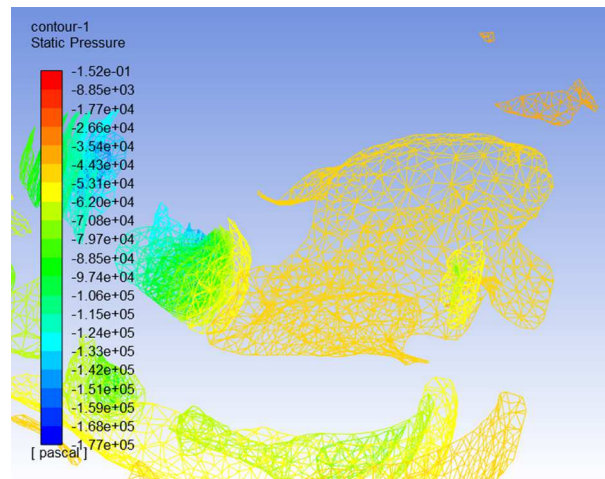

Fig. 7. Partial pressure nephogram at the inlet of filter housing

5. Analysis and improvement of the intake pipe structure

5.1. Structural analysis of the intake pipe

In order to verify feasibility of the improvement measures and provide a basis for the improvement measures, the following simple local pipelines are simulated and analyzed:

- (1) During numerical simulation and analysis of the simple local pipe of the engine intake pipe, the air is set to enter the local pipe with the speed of 10 m/s, which turns too fast and gently, as shown in Fig. 8a and 8c, but the reversing angle is 90 degrees.

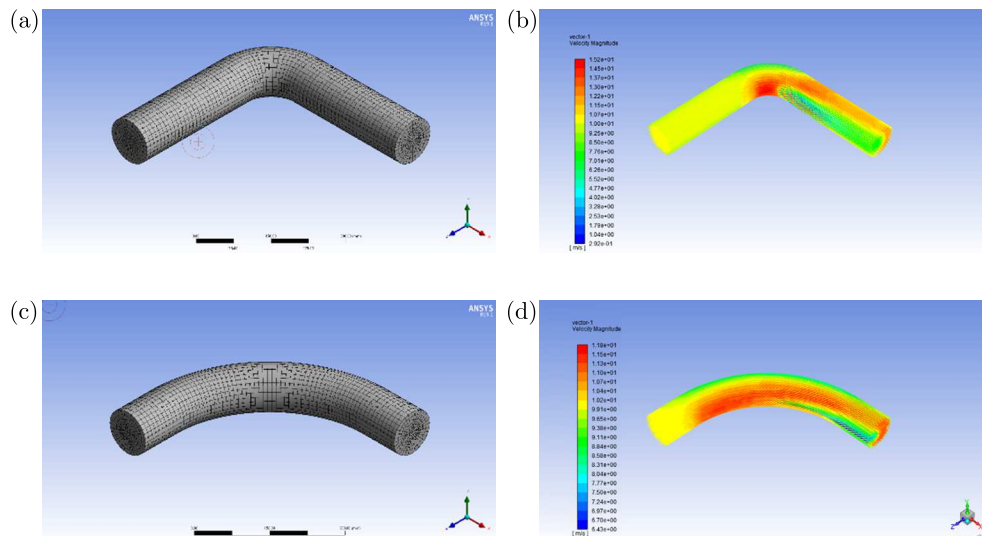

Fig. 8. Three dimensional modeling and velocity cloud chart comparison of simple local pipelines

It is found that when the inlet pipe turns too sharp, the velocity cloud diagram is as shown in Fig. 8b. Due to its flow inertia, the turning speed becomes larger, which is easy to produce a turbulent flow, and the flow velocity near the inner wall of the inlet pipe is easy to become larger, which consumes a lot of intake energy and is not conducive to the intake. On the contrary, when turning of the air inlet pipe is relatively gentle, the velocity cloud diagram is as shown in Fig. 8d. The air velocity in the air inlet pipe is relatively uniform, which reduces the flow resistance to a certain extent. Therefore, reducing the rotation angle of the intake pipe is an effective method to improve the intake performance of the

engine intake pipe. Therefore, according to space conditions in the engine compartment, the intake pipe layout with a low curvature should be properly selected (Magdas *et al.*, 2019; Gobi *et al.*, 2019).

- (2) When the engine intake pipe lacks the necessary air flow guide pipe wall, it is easy to increase the intake turbulence. It is not conducive to the rapid flow of the air in the intake pipe. An appropriate application of the corresponding guide device can reduce or even avoid the generation of turbulence that hinders the flow of the air in the intake pipe. The air flow of 10 m/s is introduced into the ordinary and improved pipes with diversion grooves respectively, and their simulation analysis is carried out. As shown in Fig. 9, comparison of the air flow in a section of the pipeline for the same parameters without and with the guide groove is shown.

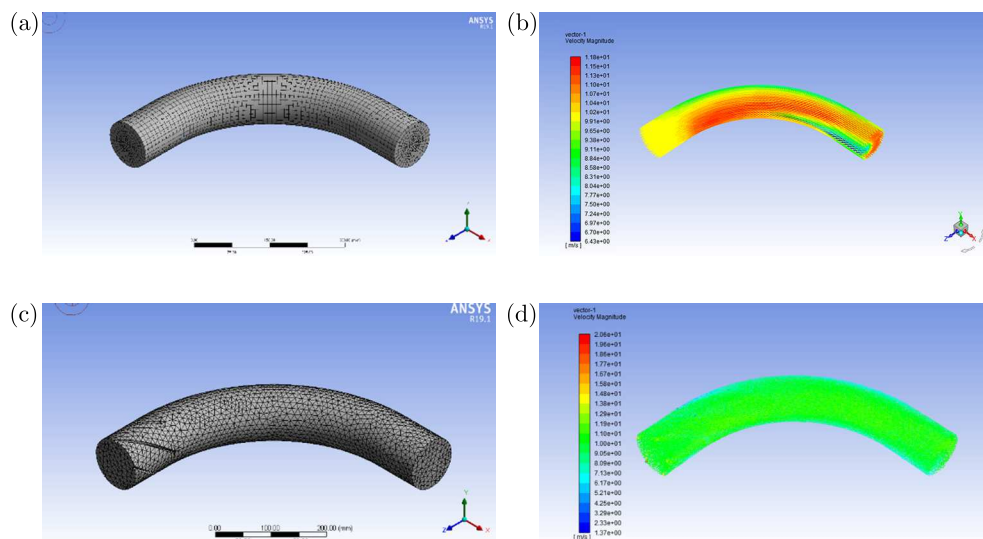

Fig. 9. Three dimensional modeling and comparison of the velocity contour in a simple local pipeline diversion channel

Through the comparison of simulation, it can be seen that there is no pipeline velocity cloud diagram with the guide groove, as shown in Fig. 9b. There is a certain obstruction in the process of air inlet, and the uneven distribution of air inlet velocity is not conducive to the rapid air inlet. The velocity cloud diagram in the pipe after setting the guide groove at an angle of 30° to the axis direction is shown in Fig. 9d. In the process of air intake, the intake vortex is formed due to action of the guide groove, which reduces the intake loss caused by bending, reduces the back pressure on the inner wall due to the airflow inertia, and makes the air flow in the intake pipe smoother. According to the local simulation experiment, the air inlet performance of the intake pipe can be improved by setting the guide groove at the appropriate position.

5.2. Improvement measures for the intake pipe

According to the results of simulation analysis, such as speed, air pressure, density and shock cloud diagram, a specific improvement is achieved out under the condition of taking effective measures:

- (1) Guide and optimize the inlet of the engine intake pipe, as shown in a mark in Fig. 10, introduce engine intake pipe inlet fillet guide improvement, modify the inner wall of the inlet to a fillet with a radius of 100 mm inclined to the direction of the narrow inlet, pass it with a smooth curve, so as to help the vehicle obtain more air brought by the oncoming wind during riding. At the same time, the air inlet obstruction caused by edges and corners

is reduced. As shown in Figs. 9c,d, the narrow inlet of the engine intake pipe is set with a radius of 60 mm, and the fillet is optimized to increase the inlet area, increase the fluency of the upwind intake and reduce the intake resistance.

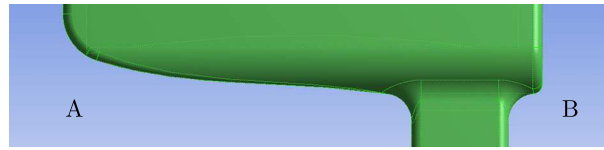

Fig. 10. Improvement of the fillet guide of the air inlet in the air inlet pipe

- (2) An appropriate vortex guide groove is applied at the sharp bend in the middle of the pipe, as shown in Fig. 11, to help the air take the central axis of the pipe as the rotation center, and rotation of the vortex to quickly pass through the curved pipe to reduce generation of the turbulence is achieved.

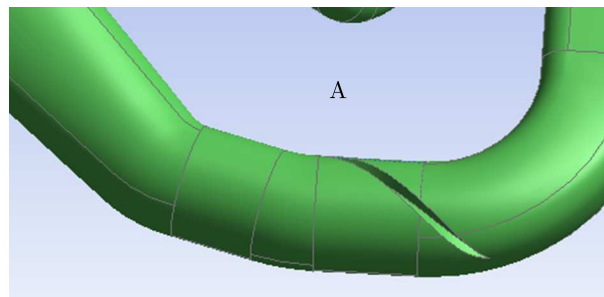

Fig. 11. Improvement of the diversion groove in an excessively sharp bend of the air inlet pipe

- (3) The improvement of the filter housing is shown in Fig. 12. The excessive fillet improvement is cancelled at the inlet of the filter (C in Fig. 12) to provide necessary airflow guidance support to help the airflow smoothly enter the air filter. Large arc fillets with a half diameter of 150 mm and 100 mm are added on the air filter housing (A and B in Fig. 12) to help the airflow change direction and achieve the purpose of rapid filtration. At the same time, it ensures the maximum efficiency of inlet filtration.

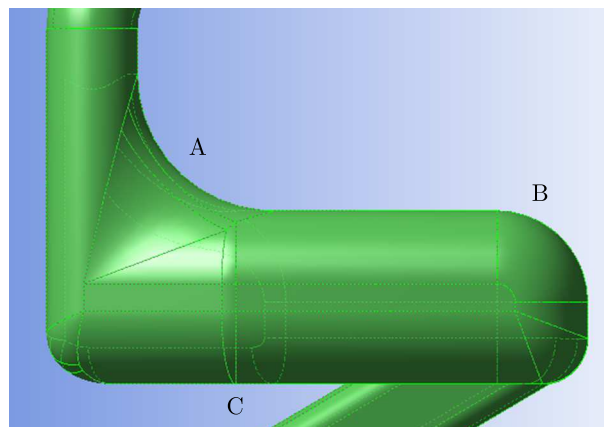

Fig. 12. Filter housing fillet improvement

- (4) A vortex guide groove is applied at the inlet of the pressure stabilizing chamber of the intake pipe (as shown in Fig. 13), so that the intake air flow enters the large angle curved pipe in front of the pressure stabilizing chamber in the form of a vortex under the action

of the guide groove, so as to improve the flow rate of the intake air into the pressure stabilizing chamber, and then increase the flow rate of the air into the intake manifold, so that the air is quickly sucked into the cylinder from each intake manifold.

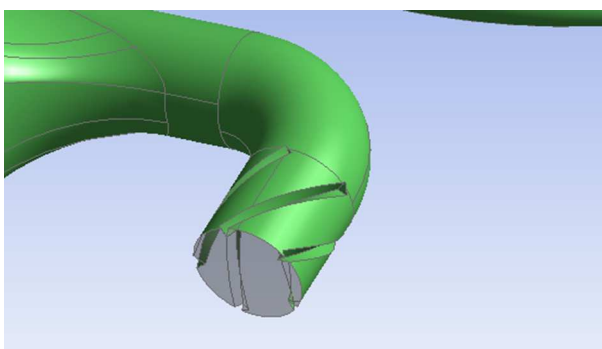

Fig. 13. Improvement of the guide groove at the inlet of the pressure stabilizing chamber

According to the above improvement measures, a three-dimensional model of the fluid control domain of the intake air flow of the intake pipe after the improvement of the automobile engine is established, as shown in Fig. 14.

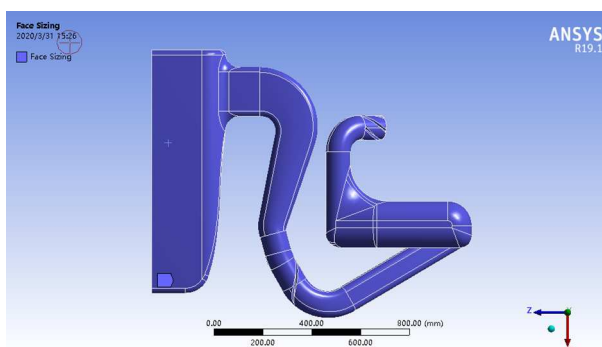

Fig. 14. Modeling of the fluid control domain of the optimized intake pipe

6. Comparison of improvement results of the intake pipe

The optimized three-dimensional model of the fluid control domain of the intake pipe has been imported into the Fluent module of Ansys for simulation analysis, and the results were compared with the simulation data before the improvement:

- (1) The intake air flow line diagram from numerical simulation before and after improvement is shown in Fig. 15a and 15b, respectively.

Through comparison, it can be seen that the fluctuation of the air flow diagram in the gas pipe before improvement is small in the early stage, but with increasing duration of the simulation process, the fluctuation begins to stabilize in a large range and continues to decline, and the comprehensive flow rate significantly decreases. The optimized intake pipe performs better in the intake response. Although the fluctuation in the early stage is large, it is more stable in the later stage, and the comprehensive flow rate is less than that before the improvement. The intake performance of the optimized intake pipe is improved, which is conducive to the continuous operation of the engine and ensures continuous and reliable intake of the engine.

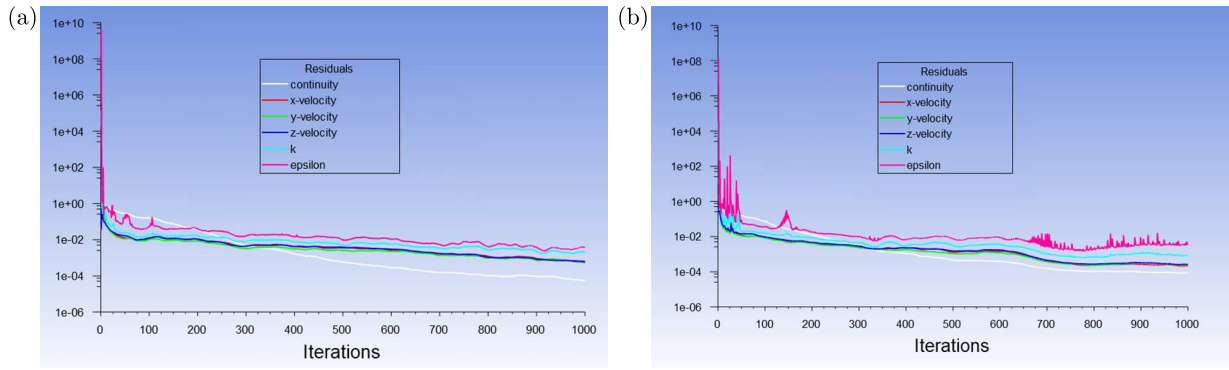

Fig. 15. Air flow line diagram of the air inlet pipe before and after improvement

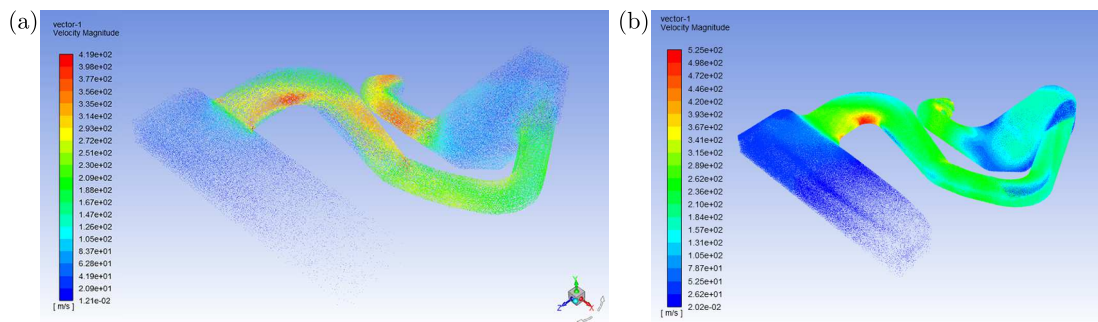

Fig. 16. Cloud chart of air velocity before and after improvement

- (2) Before and after the improvement, the numerical simulation intake air velocity contour is shown in Fig. 16a and 16b, respectively.

The comparison shows that the optimized intake pipe has a better intake efficiency at the inlet of the intake pipe. The maximum speed in the intake pipe is 524.57 m/s and the minimum speed is 0.02 m/s. The air flow at the air inlet and outlet of the intake pipe is 2.80 kg/s and -2.80 kg/s, respectively, which conforms to the law of mass conservation. The maximum and low speeds are increased by 106 m/s and 0.01 m/s, respectively. The air intake per unit time is increased by 0.4 kg/s compared with that before the improvement. In particular, the left side can collect the air more effectively to enter the narrow inlet of the intake pipe, which can effectively improve the cross-sectional average air velocity in the intake pipe. The vortex guide groove set at the sharp turn in the intake pipe can effectively apply the air flow in the intake pipe through the bend in the form of vortex, improve the intake condition at the bend of the intake pipe, reduce the vacuum caused by poor intake, and improve the intake response in a short time.

- (3) The local velocity contour of the intake air flow in the air cleaner housing from numerical simulation before and after the improvement is shown in Fig. 17a and 17b, respectively. Through comparison, the vacuum degree in the optimized air filter housing is significantly reduced and the air inlet is smoother, which is conducive to improving the filtering efficiency of the air filter to a greater extent and reducing the air inlet resistance caused by the edges and corners of the housing. The optimized speed of air inflow, air filtration and air outflow in the shell is significantly accelerated, which improves the intake response of the engine intake pipe. It is conducive to improvement of the overall intake efficiency of the intake pipe, and then improvement of the performance of the engine.

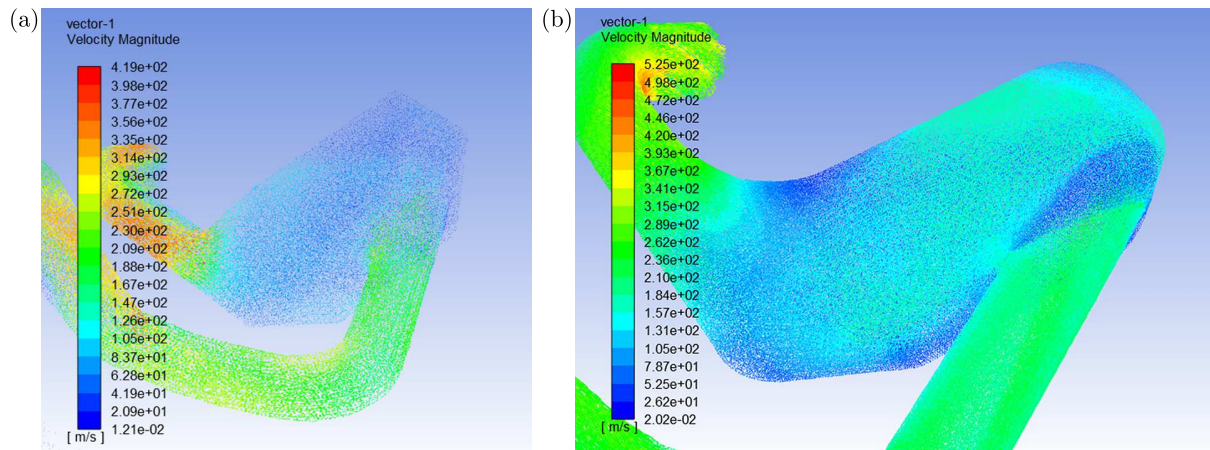

Fig. 17. Cloud chart of air flow velocity in optimized front and rear filter housings

7. Conclusion

In this paper, a three-dimensional model of an intake pipe is established by SolidWorks three-dimensional modeling software. The Fluent module of Ansys is used to simulate and analyze the air flow state of the engine intake pipe, and deficiencies in the design of the existing engine intake pipe are found out, including too large angle of the pipe, lack of necessary support or excessive fillet. The fillet improvement shall be cancelled or reduced, and the position of the air inlet shall be surrounded by the inner wall of the pipe as far as possible to increase the pressure effect of the facing air flow. The innovation puts forward the improvement measure of setting a guide groove at the position with too large angle to help the intake air flow pass through the intake pipe bend quickly and evenly, and establishes a three-dimensional model of the improved intake pipe fluid control domain. Through simulation and comparative analysis, the optimized engine intake pipe has a good intake response, which is more conducive to the engine to inhale more air in a short time. The maximum and low speeds in the intake pipe are increased by 106 m/s and 0.01 m/s, respectively, and the air intake per unit time is increased by 0.4 kg/s. The cross-sectional velocity distribution perpendicular to the pipe wall is more uniform, which improves the intake efficiency of the intake pipe.

References

- ADITHYA K., AHMED F., PADMANATHAN P., MOHAN C.G., PRAKASH R., 2020, Design optimization of intake manifold of dual fuel engine, *Materials Today: Proceedings*, **45**, 646-651
- AGUREEV I.E., ELAGIN M.YU., PAVLOV D.V., KHMELEV R.N., 2020, Studies of the process of heating air in the inlet pipe for starting a diesel engine at low temperatures, *IOP Conference Series: Materials Science and Engineering*, **971**, 4, 042028
- DHITAL N.B., YANG H.H., WANG L.C., HSU Y.T., ZHANG H.Y., YOUNG L.H., LU J.H., 2019, VOCs emission characteristics in motorcycle exhaust with different emission control devices, *Atmospheric Pollution Research*, **10**, 5, 1498-1506
- GAO W.J., ZHOU W.W., ZHAO H.B., ZHANG Q., 2017, Analysis of flow characteristics in intake pipe of gas engine (in Chinese), *Internal Combustion Engines and Accessories*, **3**, 45-47
- GOBI K., KANNAPIRAN B., DEVARAJ D., VALARMATHI K., 2019, Design, performance evaluation and analysis of the inlet tube of pressure sensor for chamber pressure measurement, *Sensor Review*, **39**, 4, 612-621

6. KARTHICKEYAN V., 2019, Effect of combustion chamber bowl geometry modification on engine performance, combustion and emission characteristics of biodiesel fuelled diesel engine with its energy and exergy analysis, *Energy*, **176**, 830-852
7. KHOA N.X., LIM O., 2019, The effects of combustion duration on residual gas, effective release energy, engine power and engine emissions characteristics of the motorcycle engine, *Applied Energy*, **248**, 54-63
8. LI H., 2018, Application of CFD analysis in intake manifold design (in Chinese), *Proceedings of Henan Society of Automotive Engineering*, 160-166
9. LIN S.M., LV Q.H., 2019, Cause analysis and countermeasures of carbon deposition in intake pipe of EA888 engine, *Automotive Practical Technology*, **10**, 125-126
10. MAGDAS V.B., MOLDOVANU D., MASTAN D.C., 2019, Intake and exhaust pipe optimization for an internal combustion engine, *IOP Conference Series: Materials Science and Engineering*, **568**, 1, 012048
11. MAZZARO R.S., HANRIOT S.M., AMORIM R.J., MAGALHÃES P.A.A. JR, 2020, Numerical analysis of the air flow in internal combustion engine intake ducts using Herschel-Quincke tubes, *Applied Acoustics*, **165**, 107310
12. SHI D.X., GUO L.X., LI K.N., YAO C.D., YANG H.T., 2020, Effect of intake pipe structure on exhaust gas recirculation rate uniformity of natural gas engine (in Chinese), *Internal Combustion Engine Engineering*, **41**, 3, 42-48
13. SUN Z.Z., WANG B.T., ZHENG X.Q., KAWAKUBO T., TAMAKI H., NUMAKURA R., 2020, Effect of bent inlet pipe on the flow instability behavior of centrifugal compressors, *Chinese Journal of Aeronautics*, **33**, 8, 2099-2109
14. WAHONO B., SETIAWAN A., LIM O., 2019, Experimental study and numerical simulation on in-cylinder flow of small motorcycle engine, *Applied Energy*, **255**, 113863
15. WANG Y.Y., MA Z.M., HU S., WANG H.C., GAO Z.B., 2018, Study on the influence of intake manifold injection on the accelerated loading process of diesel engine, *Automotive Engine*, **5**, 14-19
16. XU M., WANG D., ZHANG Q.K., ZHANG X.L., WEI S.T., WANG X.Z., 2021, Effect of structural optimization of light truck intake pipe on flow field characteristics of the system, *Automotive Practical Technology*, **46**, 17, 128-130+141
17. YAN K.N., GENG J., WANG X.J., WANG D.J., 2020, Optimal design of intake pipe of Honda energy saving racing engine (in Chinese), *Internal Combustion Engines and Accessories*, **23**, 1-2
18. YI T., BU Y.H., CHEN M., JU J., 2018, Model reconstruction and CFD analysis of gasoline engine intake pipe based on reverse design (in Chinese), *Mechanical Design*, **35**, S1, 79-82
19. YIN A.H., LI Z.Y., WAN P.Y., ZUO F.S., 2020, Research on short circuit fault of pure electric vehicle motor based on multi parameter, *Forest Engineering*, **36**, 1, 103-108
20. ZHANG J., YE L., SUN S.L., 2019, Shuli research on optimization design and processing technology of engine intake system based on Fluent (in Chinese), *Hydraulic and Pneumatic*, **9**, 50-55
21. ZHENG Q.M., ZUO F.S., ZHU Y.X., LI Z.Y., ZHANG Y., 2019, Research on vibration of permanent magnet synchronous motor based on modal analysis, *Forest Engineering*, **35**, 5, 76-81
22. ZHUANG S.K., LIN M.S., HU B.K., ZHUANG W.J., 2020, Material technology and forming of engine variable diameter and different direction intake pipe, *Employment and Security*, **3**, 23-24