

The ship control system for trajectory tracking experiments with physical model of tanker

Leszek Morawski,
 Nguyen Cong Vinh,
 Janusz Pomirski,
 Andrzej Rak,
 Gdynia Maritime University

Abstract

This paper presents a cascade system which stabilizes the transverse deviation of the ship in relation to the set path. The ship's path is determined as a broken line with specified coordinates of way points. Three controllers are used in the system. The primary controller is the trajectory controller. It generates the set value of heading for the course control system or angular velocity for the turning control system. The course control system is used on the straight line of the set trajectory while the turning controller is used during a change of the set trajectory segment. The characteristics of the nonlinear controllers are selected in such a way that the properties of the control system with the rate of turn controller are modelled by the first-order inertia, while the system with the course keeping controller is modelled by a second-order linear term. The presented control system was tested in Matlab-Simulink environment. The results of tests performed on a lake are presented and discussed.

Keywords: Nonlinear control, ship control, track keeping

INTRODUCTION

Ship trajectory tracking is a programme control task. The trajectory along which the ship is bound to move is determined on a horizontal plane, in the system of geographic coordinates X_0Y_0 , as a broken line with defined x_ky_k coordinates of the way points (Figure 1). The required trajectory can be a safe trajectory, which leaves aside all areas threatening with collision, or a trajectory resulting from sailing directions and regulations in the water region. It can also have a form of an orthodrome, approximated by rhumb-line segments. Usually, the trajectory parts between adjacent way points are approximated by straight line segments, with the attributed directions Ψ_k measured from the X_0 axis (north). The ship has to cover each of these line segments with a given constant speed. After introducing an additional right-handed system of XY coordinates fixed to a current trajectory segment, ship trajectory tracking is reduced to the stabilisation of transverse deviations of the hull centre y on the minimal level.

Kinematical model of the process

Let us assume that the origin of the XY coordinate system for the current trajectory segment (k -th segment) is in line with the coordinates x_ky_k of its ending point. Then the transverse deviation from the trajectory is given by the formula:

$$y = -(x_r - x_k) \sin(\Psi_k) + (y_r - y_k) \cos(\Psi_k) \quad (1)$$

where Ψ_k is the directional angle of the current trajectory segment, measured from the north, and $x_r y_r$ stand for coordinates of the hull centre in the earth-fixed coordinate system X_0Y_0 .

With u and v representing, respectively, the longitudinal and transverse components of the ship speed vector, (both fixed to the hull), and Ψ standing for ship's course measured from the X_0 axis, the rate of change of $x_r y_r$ coordinates in the X_0Y_0 coordinate system is given by:

$$\begin{aligned} \dot{x}_r &= u \cdot \cos(\Psi) - v \cdot \sin(\Psi) \\ \dot{y}_r &= u \cdot \sin(\Psi) + v \cdot \cos(\Psi) \end{aligned} \quad (2)$$

while the rate of change of x, y coordinates of the hull centre in the XY system is given by:

$$\begin{aligned} \dot{x} &= u \cdot \cos(\Psi - \Psi_k) - v \cdot \sin(\Psi - \Psi_k) \\ \dot{y} &= u \cdot \sin(\Psi - \Psi_k) + v \cdot \cos(\Psi - \Psi_k) \end{aligned} \quad (3)$$

These kinetic relations define the motion of the hull in the calm waters. In case a sea current is present they have to be complemented by the current speed components.

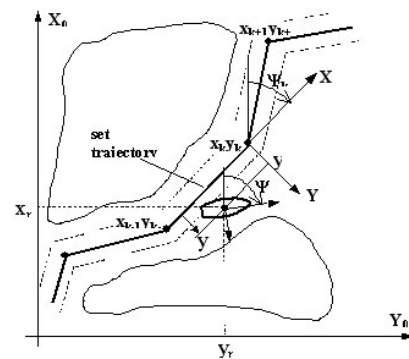

Fig. 1. The trajectory-fixed coordinate system

Steering System - Controllers

Stabilisation of the transverse deviation from the trajectory is obtained using a control system having a cascade structure, shown in Fig. 2. The main controller is a trajectory controller, also playing the role of a decision making system. It determines which, out of the two remaining controllers, is to be used for trajectory tracking. Along the straight trajectory segments it generates the assumed value $\Psi_k + \Delta\Psi_y(t)$ for the course control system. The correction $\Delta\Psi_y(t)$ depends on instantaneous scale of deviation of the hull centre from the assumed trajectory. Along trajectory parts that require large course changes a turning angular velocity controller is used. The supervising controller generates the assumed constant value of the angular

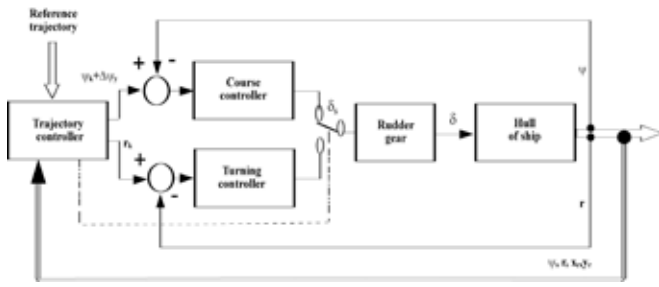

Fig. 2. Block diagram of the control system

velocity of turning and passes to the angular velocity control system. It can also generate varying values of the angular velocity in response to the speed changes of the hull translation, in order to obtain stability of the turning radius.

Linear algorithms, which are usually used in ship autopilots, can keep the stability of a course control system on a directionally unstable ship. However, a global stability requirement for controlling such a ship needs strong derivative action of the controller. High value of the derivative gain coefficient compensates the unstable pole of the object within the range of small rudder angles. It is, however, unfavourable for large rudder angles and large course deviations as it limits the turn rate, thus extending the settling time. These difficulties can be avoided by using a controller, the parameters of which are a function of the course deviation. Error deviation thresholds, which determine the changes of controller parameters, are usually selected heuristically.

Isidori [2] has proposed a simple algorithm of non-linear control. The algorithm can be most easily synthesised using a simple non-linear model of ship's dynamics. Let the object (controlled ship) be modelled by a Norrbinn model defined by:

$$T \cdot r + a_3 \cdot r^3 + a_2 \cdot r^2 + a_1 \cdot r + a_0 = k \delta \quad (5)$$

where: δ - rudder angle, r - angular velocity of hull, T, k, a_i - parameters of ship dynamics, The 3rd-order polynomial:

$$H_N(r) = a_3 r^3 + a_2 r \quad (6)$$

describes the non-linear manoeuvring characteristic generated by Bech's reverse spiral manoeuvre. For course-unstable ships $a_1 = -1$ while for those course-stable ones $a_1 = 1$.

The parameters of this model were also determined with the aid of the recorded results of manoeuvre trials of the model tanker performed on the lake [5]. A general concept of non-linear control is explained in Figure 3.

The course and turn rate determine the actual state of the ship. Here, a static-state feedback control mode is applied. The control is defined by a non-linear function of state variables. The dynamics of the steering gear is omitted during control synthesis. This simplifying assumption is fully acceptable, as it does not create significant errors in cases when the time-constant

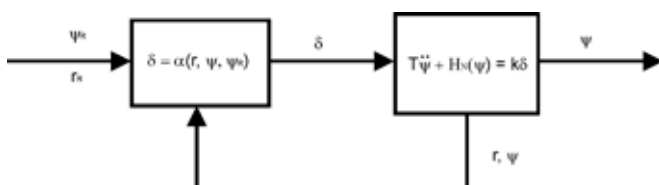

Fig. 3. Schematic diagram of the non-linear control system

of the ship dynamics is much larger than the equivalent time-constant of the steering gear [6]. The instantaneous component of the course control error:

$$e = \psi_R - \psi \quad (7)$$

where:

ψ_R - denotes desired course of the ship, is assumed to satisfy the following differential equation in the transient state:

$$\ddot{e} + \beta_1 \dot{e} + \beta_2 e = 0 \quad (8)$$

Parameters β_1 and β_2 can be determined using the natural frequency ω_n , and the relative damping factor ξ , of a closed loop system. They are equal: $\beta_1 = 2\xi\omega_n$, and $\beta_2 = \omega_n^2$. Placing the error definition from (7) into (8), and then into the dynamics model defined by (5), and setting $d\psi/dt=r$ gives:

$$\delta_\psi = \frac{T}{k} \left[\beta_2 (\psi_R - \psi) + \beta_1 (r_R - r) \right] + \frac{1}{k} H_N(r) \quad (9)$$

assuming that $d^2\psi_R/dt^2 = 0$.

This equation defines the structure of the non-linear ship course controller. The advantage of the controller is its ability to vary the derivative action, adjusting it to non-linear characteristics of the unstable object. Moreover, the control law described by (9) allows to define the characteristics of a closed loop control system in a direct way using the natural frequency of the system and the relative damping factor.

For large course changes, the reference rudder angles generated by the controller are larger than the maximum rudder angle. Then the rudder angle has to be limited, and changes of error in the control system are not defined by (8) any longer.

It is desirable for large course changes that the course change be performed at a constant turn rate. The instantaneous component of the turn rate error $e_r = r_R - r$ is assumed to satisfy the equation:

$$\alpha_1 \cdot \dot{e}_r + e_r \quad (10)$$

where r_R is the required turn rate and α_1 is a time-constant. Placing the Norrbinn model defined by (5) into (10) we arrive at the formula that determines the rudder angles during the turn rate stabilisation period:

$$\delta_r = \frac{T}{k \cdot \alpha_1} (r_R - r) + \frac{1}{k} H_N(r) \quad (11)$$

For continuous operation of the ship control system, conditions for switching between course-keeping and rate of turn controllers have to be defined.

This function is executed in the system by the trajectory controller. Along the straight trajectory segments, small deviations from the assumed trajectory are recorded and the course of the current trajectory segment $\psi_k + \Delta\psi_k$ is stabilised. The correction $\Delta\psi_k$ is a function of an instantaneous deviation y of the hull centre from the assumed trajectory. Let us assume that the transverse trajectory deviation y changes non-periodically (exponentially) during the steering:

$$y(t) = y \cdot e^{-\frac{t}{T_y}} \quad (12)$$

Then, after placing to (3) and neglecting the second term $v \cdot \cos\Delta\psi_k$ (which is small along a straight line trajectory segment) we arrive at:

$$\Delta\psi_y(t) = -\arcsin\left(\frac{y(t)}{T_y u}\right) \quad (13)$$

$$\psi_R = \psi_k + \Delta\psi_y = \psi_k - \arcsin\left(\frac{y(t)}{T_y u}\right) \quad (14)$$

As a result, the course assumed for the course control system will be equal to:

$$\psi_R = \psi_k + \Delta\psi_y = \psi_k - \arcsin\left(\text{sign}(y(t)) \cdot \min\left(\left|\frac{y(t)}{T_y u}\right|, 1\right)\right) \quad (15)$$

After analysing the results of the simulation tests the presented formula was modified by limiting the correction range to ± 90 deg.

Due to certain inertial characteristics of the object, ship trajectory tracking along the segments including course change requires starting this manoeuvre at an appropriate time instant. If it is started too late, it leads to strong overshoot of the control system. Optimisation of the steering process, or in-advance steering with sufficiently large steering horizon solve this problem. In practical execution, this task can be solved by changing, at a proper time instant, the position of the XY co-ordinate system (Figure 1). The time instant at which the position of the XY co-ordinate system is to be suddenly changed to match the next trajectory segment can be most easily defined by the time instant when the ship nears the tuning point by a certain distance referred to as the advance distance l_{wy} . The manoeuvre advance distance is a function of dynamic characteristics of the ship, its speed, turning abilities, the shape of the assumed trajectory and special requirements concerning the shape of the real trajectory of ship's motion. Figure 4 presents selected cases of possible trajectories of ship's motion for positive and negative manoeuvre advance distances. The negative advance distance means that the manoeuvre is started after the turning point has been passed by.

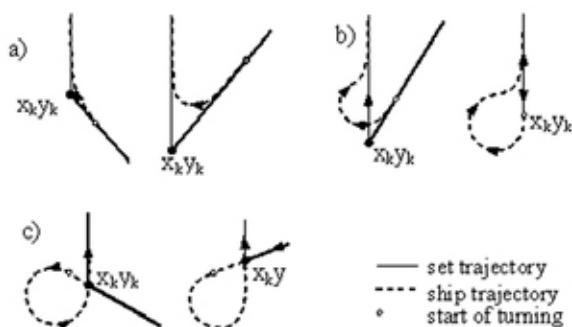

Fig. 4. Examples of the assumed and real trajectories of the ship

During trajectory tracking along straight line segments, the scales of course, rudder angle, and angular velocity deviations are small. Therefore in those situations switching on the turning controller gives no benefit. For large reference course changes, the turn rate that is reached when the course controller is switched on corresponds to the maximum rudder

angle and is usually larger than the rudder angle corresponding to the required turn rate. Therefore, in those cases the turning controller is to be switched on as it generates smaller rudder angle than the course controller. Generally, the object is to be controlled by that controller in the control system, which calculates smaller commanded rudder angle. The condition for using a rudder angle generated by one of the two controllers is the following:

$$\delta = \begin{cases} \delta_r & \text{if } \delta_r \leq \delta_\psi & \text{turning controller} \\ \delta_\psi & \text{if } \delta_\psi < \delta_r & \text{course controller} \end{cases} \quad (16)$$

The above switching condition can be applied for steering, during which the real trajectory is inscribed into the arms of the angle created by two adjacent segments of the assumed trajectory (Figure 4a). For the remaining variants of steering (Figure 4b and c) the switching condition is the following :

$$\begin{aligned} \psi - \psi_k &\geq -k_p \cdot y & \text{for } y < 0 & \text{turning controller} \\ \psi_k - \psi &\geq k_p \cdot y & \text{for } y > 0 & \text{course controller} \end{aligned} \quad (17)$$

Hardware Setup

The tanker „Blue Lady” model was used for tests of the control system on the lake. It is a physical model of the tanker, done in scale 1:24, which is usually used for training navigators at the Shiphhandling Centre of the Foundation for Safety of Navigation and Environment Protection, on the lake Silm near Ilawa [3]. Basic characteristics of the model are collected in Table 1. The shape of tanker and general diagram of the control system is shown in Figure 5.

Item	Ship	Model
Length overall	330.65 [m]	13.78 [m]
Beam	57.00 [m]	2.38 [m]
Draft – full load	20.60 [m]	0.86 [m]
Displacement – full load	323 660 [t]	22.83 [t]
Draft – ballast	12 [m]	0.5 [m]
Displacement – ballast	176 000 [t]	12.46 [t]
Speed	15.2 [kn.]	3.1 [kn.]

Table 1 Parameters of the Ship and the „Blue Lady” model

The control system consists of two PC-type computers, Anschütz Standard 20 gyro-compass, DGPS receiver Leica System 500 as well as an ultrasonic anemometer for measuring speed and direction of wind. Current levels of the control signals are measured and passed, in feedback, to the concentrator via 12-bit A/D converters. The concentrator, the design of which bases on the M6800 microcontroller, sends measurement data and receives control signals via RS232 link. The two RS 422 serial links with NMEA 183 standards are used to connect of gyro-compass and DGPS receiver. Due to the presence of lake waters which cause the varying humidity and temperature, that surround the research environment, all actuator, as well as control and measuring signal lines are galvanically separated.

The basic component of the real-time system software is the Matlab-Simulink environment, with the toolboxes of Real Time Workshop, xPC Target, Control System Toolbox, Signal Processing Toolbox, and System Identification Toolbox. Predominant idea of building the software was to employ MATLAB's power into control algorithms development process. This software give opportunity to use the built-in procedures of control, signal processing, and many more algorithms collected in toolboxes. The user is also separated from the hardware and software

level problems and can use high level MATLAB language and Simulink graphical programming [4] to test his own ideas instead of spending hours coding C. The dedicated drivers (controllers) for serial ports RS232/ RS422 with NMEA183 protocols were written in C language and implemented to Simulink diagrams in the form of S-functions [4]. Thus the user has an easy access to input and output signals at the Simulink diagram. Toolboxes RTW and xPC target as well as C compiler are used for creating the kernel of the real-time system and the control programme.

After compilation, the kernel and the control programme are loaded to one of the IBM PC deck computers via ethernet connection. This connection is also used for initiating, stopping, logging, and changing parameters in the control-and-measurement algorithms started from the level of the Simulink scheme, installed on the other PC. Selected signals of the already started process can be monitored and recorded in the real-time system and then, after the process has been completed, imported to the Matlab level.

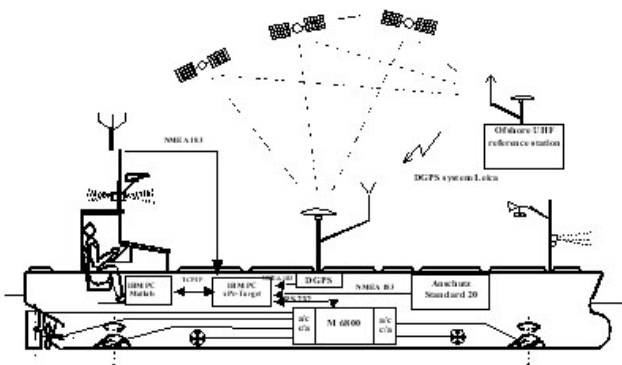

Fig. 5. General scheme of the control system on the "Blue Lady" training boat

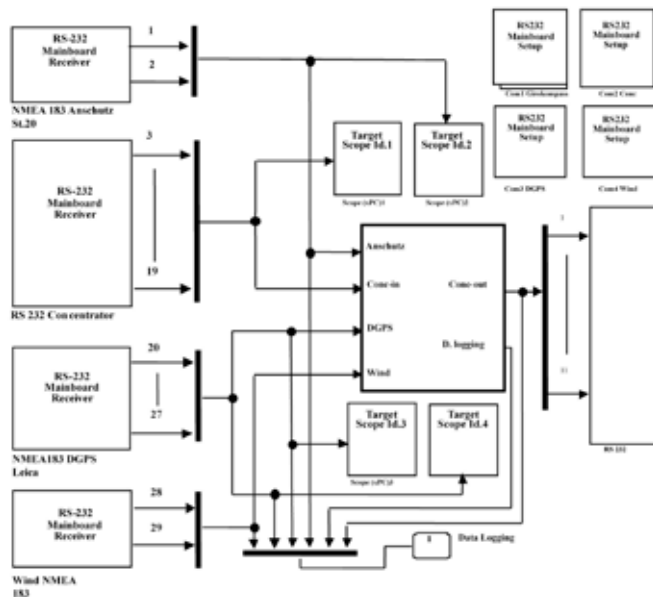

Fig. 6. General block diagram of the Simulink control system on the "Blue Lady" tanker model

A general block scheme of the developed software is given in Figure 6. The examined controller is placed in the central block. The controller can use signals received from input ports and generate output signals to control the model actuators.

Results of the Experiment

The tests of operation of the control algorithm were performed for various speeds of the model tanker, and for various disturbances. Figures 7 and 8 show the obtained trajectory and selected time-histories of the course, angular velocity, transverse deviation from the reference trajectory, and rudder angle during steering the model tanker along the assumed trajectory that included turning manoeuvres with various angles and course stabilisation on a straight trajectory segment.

The presented trajectories correspond to trials at the model speed equal to „half ahead” 0.96m/s and the set parameters of controllers of the course $\beta_1=2\xi\omega=2\cdot0.4\cdot0.1T$, ($T=48.5$ sec) $\beta_2=\omega^2=(0.1T)^2$ and angular velocity $\alpha_1=0.1T$. The angular velocity of the turning was stabilised at the different level of range 0.5 to 1.3 deg/s while the advance distance of the turning was chosen individually for each manoeuvre.

Conclusions

On the basis of the performed trajectory tracking experiments the following conclusions can be formulated :

- The presented algorithm of ship trajectory tracking reveals good dynamic characteristics

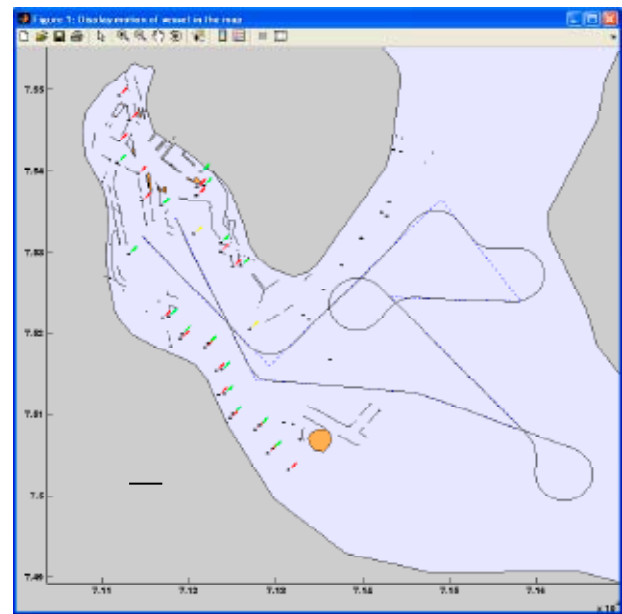

Fig.7. Simulation results of trajectory tracking.

- During synthesis of trajectory tracking, dynamic characteristics of the course and angular velocity control systems are modelled by characteristic equations of the second and first order, respectively. Therefore they can be easily modelled using, for instance, natural frequencies and damping factors of the control system, or the time constant of the angular velocity stabilisation system.
- Using different turning manoeuvre advance distances and set different turning velocity, one can obtain various shapes of the trajectories: either inscribed into the arms of the angle created by two adjacent segments of the assumed trajectory, or going beyond that area.
- The accuracy of trajectory tracking along the selected trajectory segments was not worse than 1m.

- The proposed method of switching the controllers is relatively simple. In case the course change is small during the trajectory segment change manoeuvre, the controlled ship does not reach the required angular velocity fast enough. That is why the turning controller switches on for a short time period only

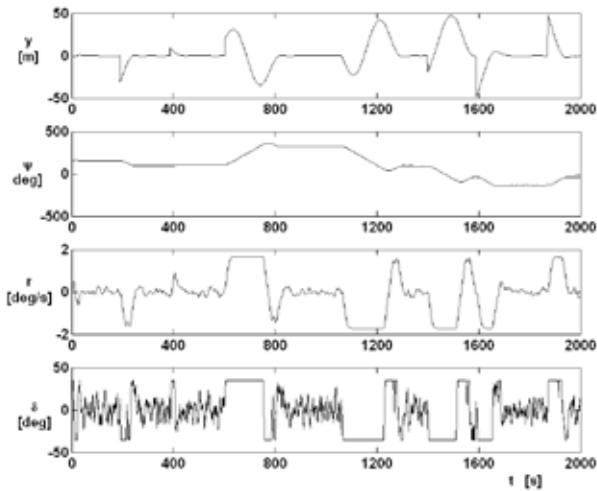

Fig. 8. Time-histories of transverse deviation from the trajectory y , the real course Ψ , angular velocity r , and rudder angle δ during the steering of the model tanker along the assumed trajectory



References

- [1] Gierusz W., "Simulation model of the ship handling training boat Blue Lady", Proceedings of IFAC Conference on Control Applications in Marine Systems CAMS 2001, Glasgow, 2001.
- [2] Isidori A., Nonlinear Control Systems, Springer Verlag, Berlin-New York, 1989.
- [3] Kobyliński L., (ed.) Manned Model Course on Handling of Large Ships and Ships with Unusual Manoeuvring Characteristics: Course File, Ship Handling Research and Training Centre, Ilawa, 1999.
- [4] Matlab Simulink - User's Guide, The MathWorks Inc., Natick, MA, 2002
- [5] Morawski L., Pomirski J., Rak A., "Non-linear Control of Course-Unstable Ship: Experiments with Physical Tanker Model", Proceedings of 10th IMAM Congress, Rethymnon, Crete, 2002.
- [6] Van Amerongen J., Adaptive Steering of Ships – A Model Reference Approach to Improved Manoeuvring and Economical Course Keeping, PhD Thesis, Delft University of Technology, 1982.

