

Lechosław Tuz

QUALITY OF MARKS ON METALS MADE WITH THE USE OF THE Nd:YAG LASER ENGRAVING METHOD

JAKOŚĆ ZNAKÓW NA MATERIAŁACH METALOWYCH WYKONANYCH METODĄ GRAWEROWANIA WIĄZKĄ LASERA Nd:YAG

Abstract

The results of the investigation concerning the influence of engraving parameters on the mark quality and material removal rates from panels made by different types of metals by the Q-switched diode-pumped Nd:YAG laser are presented in this paper. Quality of marks is examined by considering readability and durability as the function of material removed and parameters. The parameters under consideration are: the average power, pulse frequency and surface scanning velocity. The results disclosed that laser engraving can be applied in marking metals successfully.

Key words: *laser engraving, laser marking, Nd:YAG laser, metals*

Streszczenie

Przedstawiono wyniki badań dotyczących wpływu parametrów grawerowania na jakość znaku i szybkość usuwania materiału z płyt wykonanych z różnych metali. Jakość znaków rozważano pod względem ich czytelności i trwałości oraz w funkcji odwzorowania zadanego kształtu przy różnych parametrach procesu. Parametrami branyymi pod uwagę były: średnia moc, częstotliwość impulsów i prędkość skanowania powierzchni. Wyniki ujawniły, że grawerowanie laserowe może być stosowane z powodzeniem w znakowaniu metali.

Słowa kluczowe: *grawerowanie laserowe, znakowanie laserowe, metale, lasery Nd:YAG*

Lechosław Tuz Ph.D. Eng.: AGH University of Science and Technology, Faculty of Metals Engineering and Industrial Computer Science, Krakow, Poland, ltuz@agh.edu.pl

1. Introduction

The development of lasers concerns not only welding or cutting operations, but more often techniques of surface modification thanks to a high degree of automation and the possibility of non-contact working with high beam power range. That lasers are made useful for different materials processing.

In recent years, lasers were used in the process of marks making on products, which aims in their further identification. Qi et al. [1] noticed that conventional marking methods such as ink-marking, mechanical engraving, labeling or electro-chemical treatment in comparison with laser marking are extensively used in product marking processes by industry. The most popular laser markers are Q-Switched CO₂ laser and Nd:YAG laser with an average power level of several tens of watts. In the past few years, the above mentioned processes were applied in some experiments i.e. by Qi et al. who used Nd:YAG laser for stainless steel marking or by Ming-Fei et al. [2], who applied CO₂ pulsed laser for eggshell marking.

The advantages of those lasers are: their non-contact working, flexible and susceptible to automation, high repeatability and high scanning speed. Additionally, nevertheless low average power, it is possible to make the inscriptions on a wide range of materials. Kuo and Lin [3] performed an experiment with glass marking using multiple laser beam. Noor et al. [4] applied successfully the Nd:YAG laser for ceramic and plastic marking. Technology of wood engraving and parameters of this process are obtained by Leone et al. [5]. Cheng-Jung et al. [6] investigated the effects of feed speed ratio, laser power on engraved depth and color difference of Moso bamboo lamina. Qi et al. studied the influence of the pulse frequency of the laser beam on the mark depth, width and mark contrast of the stainless steel.

Products marked by unique identification tags, such as logotypes, serial numbers, barcodes or 2D data matrix marks serve a multitude of functions, from individual product customization and tracing the origin to the performance and maintenance history of certain components. The marking of these products is also important and useful as a supportive tool in the quality and storage management of products, as a result of the flexibility of the laser marking method on the numbering of products as well as the possibility of their further optic identification. Moreover, laser marking is often used in decorative applications and secure applications.

Two main techniques depended on the system of beam focusing on material surface are known in the method of laser marking. The first one is described by Shin et al. [7], who applied the laser marking process for the electrochemical etching of stainless steel. There is used a mask with the designed sign. Laser marking with masks is usually applicable when there is a need for preparing many of the same and simple signs, i.e. the brand-name on the product. In the applications, when variable and unique tags are prepared, there is used a technique of laser marking involving steering light beam on the material surface. This kind of method is described i.e. by Qi et al. In this method, a beam of focused light is directed across a material surface by mirrors mounted on the high-speed, computer-controlled galvanometers. The flat-field lens focus laser beam to the spot with a diameter of less than 0.01 mm and guarantees that high and non-variable average power density is achieved during travel of the spot on the surface and in the whole work area. In the Figure 1 the basic concept of beam steering used in the laser marking is presented. In this technique, the relationship between the marking parameters such as laser average power, pulse power, pulse frequency and changes

in the material surface such as marking depth, width and contrast is observed. Heat which is generated as the result of power density on material surface, allows for the use of different processes, such as engraving, annealing, ablation, carbonization or foaming, for marking. This technique is mainly made use of in industrial applications.

The aim of the present research is to study the quality of marks reached on different metals by laser engraving. The Q-switched diode-pumped Nd:YAG laser is used in the research. Moreover, the influence of engraving parameters on material removal and engraved depth, lines width and parallel and the contrast between rough material and line are examined. The investigated parameters are: the average power, pulse frequency and marking velocity on target surface.

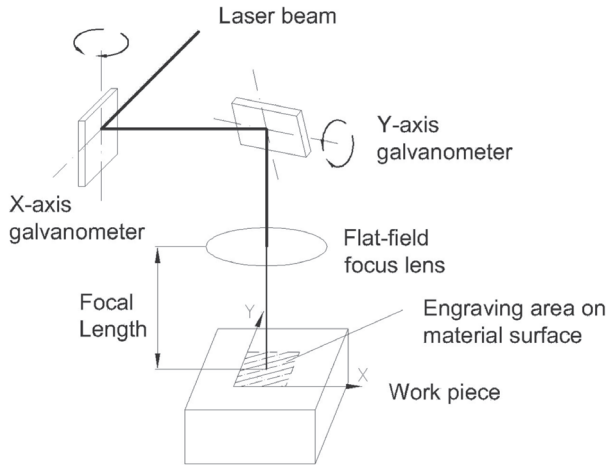

Fig. 1. Concept of beam steering in the laser marking and engraving process

2. Equipment, materials and experimental procedure

An industrial Q-switched diode-pumped Nd-YAG laser working at a wavelength of 1064 nm was used in the experiments. The laser is characterized by a maximum average power of 8 W, pulse frequency ranging from 5 to 50 kHz and a scanning velocity up to 600 mm/s. In the laser head, the beam is firstly expanded, then directed towards mirrors of galvanometers to the flat-field lens where the light beam is focused onto the material's surface. The galvanometers, steered by the computer, move the light beam, the first one on the X-axis and the second one on the Y-axis. Correlation of the movement gives the possibility of marking straight and arc lines. The focal length is 100 mm and the focused light beam diameter, which is indicated by the manufacturer, is 26 μm . The pulse duration indicated by the manufacturer is 140 ns. The work area is 100 \times 100 mm wide. The laser system can be controlled by a controller or by a PC with customized CAD-CAM software. The controller allows us only to generate engraving parameters for the whole process, software allows us to generate patterns with the engraving parameters for the whole process or defined as independent points or lines with different parameters and to control the working parameters.

The engraving parameters are: marking velocity (25, 50, 100 mm/s), pulse frequency (5, 10 kHz) and the average power (4.8, 6.4, 8,0 W). The pulse power density depends on the focused beam diameter and the pulse repetition frequency, which is determined by the average power, the pulse duration and pulse frequency. The pulse power density is an important indirect parameter which decides about the material ablation.

Table 1. Chemical composition of engraved metals

Metal	Alloying elements [%]									
	Cu	C	Si	Mn	P	S	Cr	Ni	Ti	other
X6CrNiTi18-10	–	≤ 0,1	≤ 0,8	≤ 2	0,045	0,03	17+19	8+10	5%C <0,8	–
08X	–	0,05 +0,11	max 0,04	0,25 +0,5	max 0,04	max 0,04	–	–	–	–
Cu-ETP	≥ 99,9	–	–	–	–	–	–	–	–	rest
X18CrN28	–	≤0,15	≤0,1	≤0,8	≤0,045	≤0,03	24+27	–	4%C -0,8	–

The metals used in the investigations were: commercial copper (Cu-ETP), heat-resisting steel (X18CrN28), construction steel (08X) and stainless steel (X6CrNiTi18-10) with the chemical composition given in Table 1. The samples, which are to be marked, are cut from the sheet with 2 mm thickness. The mark is designed with the consideration of horizontal, vertical and with an angle of 45° straight lines and arcs. Moreover, the lines are crossed but a part of them is engraved only once per point, and the rest is engraved twice per point. The designed sign is 6 mm wide and 6 mm high.

The problem statement of the experimental part is formulated as follows:

- firstly, for producing visible marks it is necessary to determine the optimum operating conditions; in this part, three parameters: the average power of laser, marking velocity and pulse frequency are taken under consideration;
- secondly, using the optic microscope with image analysis software the quality of the engraved marks in the function of parallel, straightness and width of lines and diameter of spots are determined;
- thirdly, the depth of the marks measured by Taylor Hobson surface analyzer as a consequence of the engraving parameters is determined.

3. Results

3.1. Marking parameters

Using different combinations of parameters, the changes in engraved marks are observed. It means that it is necessary to find the right parameters for different materials and the quality of the marks as a function of the average power, frequency and the marking velocity, highly depends on the optimum values of them.

Continuous lines with low contrast are observed when using low average power and small marking velocity and low frequency. It is the consequence of low pulse power density. One parameter increase i.e. the average power, makes better contrast and non-visible spots observed. The marking velocity increase influences the discontinue

lines with very low contrast. Lower contrast is noticed also for increasing the pulse frequency. The change of two of parameters i.e. the average power and marking velocity increase, causes appearing of the discontinues lines with good contrast of spots. The average power and frequency increase makes it possible to achieve continue lines with good contrast and non-visible spots. Changing all parameters causes limited improvement of lines continuity and contrast.

3.2. Optical analysis

Figures 2 and 3 present the engraved marks using all examined materials made by the right parameters. The surface of the materials after the engraving process has to be cleaned by dry material.

All parts of engraved marks are visible and easy to identify. Lines are darker than the material surface and they are dark brown in colour. It is suspected that it is the result of intensive corrosion processes taking place during engraving without shielding gas. The contrast between engraved lines and surface is lower for heat-resisting steel (H25T) where the contrast is limited by the darkness of the surface. In these samples lines are brighter than the material surface. Similar results were obtained also for copper, but in these samples in the centre of lines it is observed the metallic lustre and the sides are dark. The spots engraved twice are brighter than other spots and have metallic lustre. Such an effect is well observed in the construction steel (08X) and is presented in Figure 3. The light change, as a result of change of magnification, shows that visible differences of spot colour are noticeable because the colour of these areas for all materials is similar. Only the lustre of the spots is different.

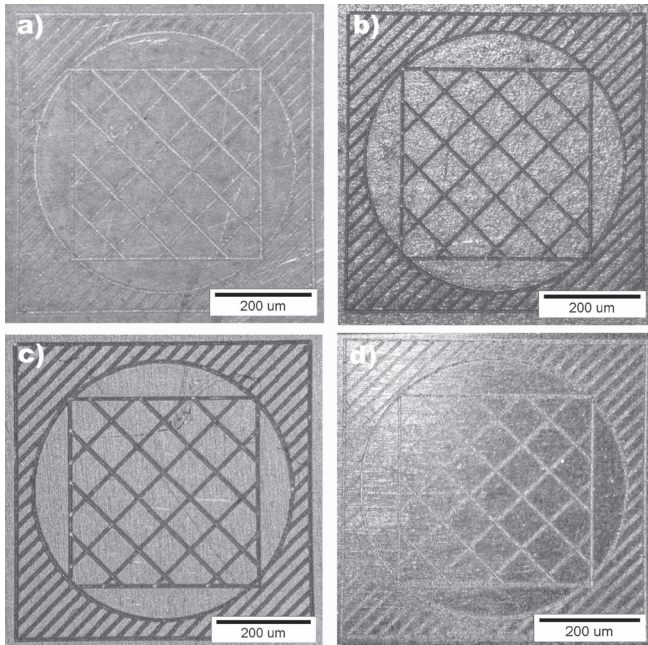

Fig. 2. Engraved marks on: a) the copper Cu-ETP, b) construction steel 08X, c) stainless steel 1H18N9T, d) the heat-resisting steel H25T, magnification x15; light microscopy

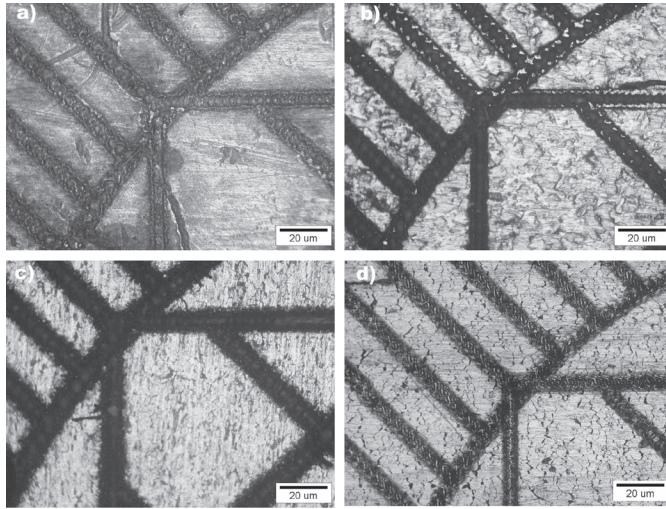

Fig. 3. Engraved marks on: a) the copper (Cu-ETP); b) construction steel (08X), c) stainless steel (1H18N9T), d) the heat-resisting steel (H25T), magnification x100; light microscopy

In the marking directions (horizontal, vertical and with angle of 45°), the marked lines are parallel. Moreover, the right angle between lines in all directions is kept and the shape of the circle is not deformed. The shape of lines under high magnification is possible to observe and is presented in Figure 4. The lines are built by the spots with $40\ \mu\text{m}$ distance between them. It is a reason straightness of lines is not deformed.

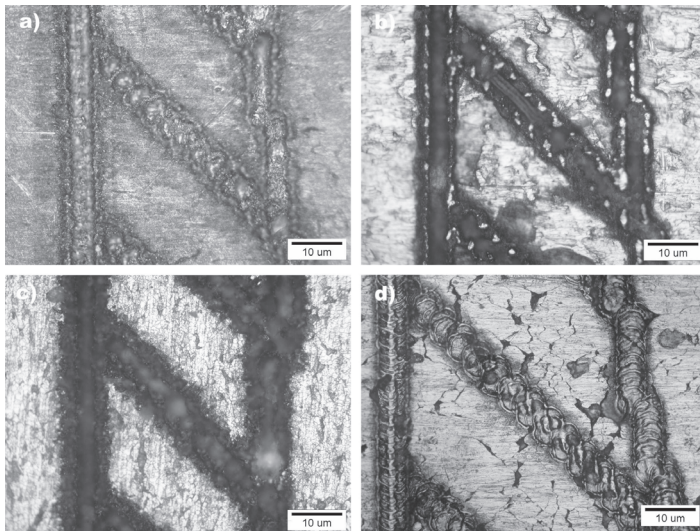

Fig. 4. Engraved marks on: a) the copper (Cu-ETP); b) construction steel (08X); c) stainless steel (1H18N9T); d) the heat-resisting steel (H25T), magnification x200

The darker area is the result of the heat affected zone is observed close to the lines. By high contrast, this darker area improves the shape of the lines during the analysis of the macrostructure. The improvement of readability is supposed to appear through the

high contrast of the lines in the process of scanning the marks with the use of optic analysers. It is suspected that the abrasion hardness of these areas is very low and will decrease the contrast.

Using such a magnification, the shape of the circle is recognized to be deformed as the consequence of the software design resolution. Such an effect is also expected for lines with angel non equal to 45°, what is verified by engraving additional marks on the construction steel (08X). In the case of the additional marks the word “YAG” is engraved and written with capital letters.

3.3. Line measurements

For the line width and spot surface measurement the optical microscope with AnalySIS software was used. The relative high of marks and the areas close to them was measured by surface analyser.

The results of spots and lines measurement are presented in Table 2. It is observed that the width of the lines for each material is quite similar ($\pm 1 \div 2 \mu\text{m}$) but differs for other materials i.e. for stainless steel is 31 μm and for heat resisting steel is increasing up to 58 μm .

Table 2. Width of shape lines on materials being treated

Line		Cu-ETP	08X	1H18N9T	H25T
Straight, μm	Outflow	45 ± 1	46 ± 2	31 ± 2	58 ± 1
	Colour change	67 ± 3	64 ± 2	93 ± 3	63 ± 3
Angle 45°, μm	Outflow	59 ± 2	52 ± 2	33 ± 3	62 ± 2
	Colour change	70 ± 3	75 ± 2	97 ± 5	67 ± 3
Spot surface, μm^2		1602 ± 12	1659 ± 13	749 ± 11	2621 ± 9
Engraving parameters: Power: 8 W; Frequency: 5 kHz; Engraving velocity: 25 mm/s					

The colour change along the lines is the result of the outflow of material from the engraving area what is shown in Figures 5 and 6. The material being treated is of low corrosion resistance what is marked also by colour change – dark brown. Moreover, this areas has low abrasion hardness.

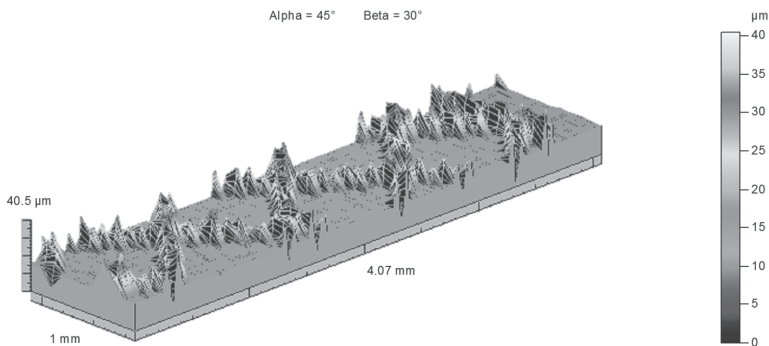

Fig. 5. Surface profile

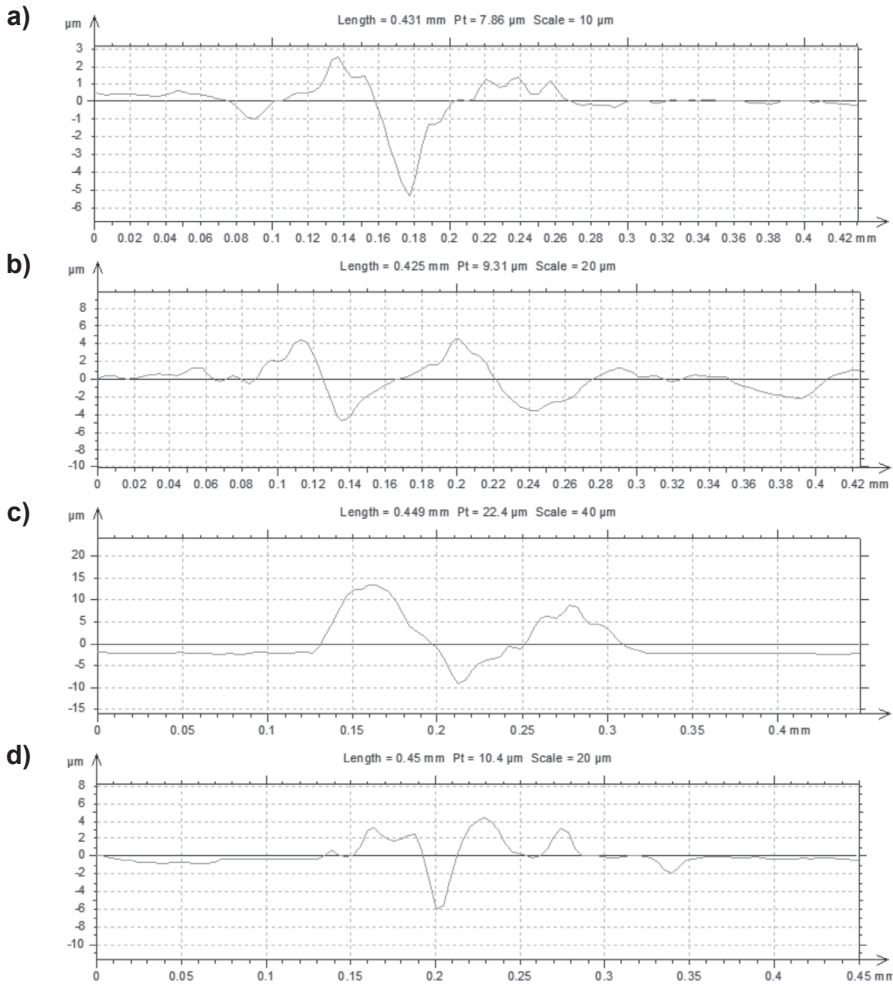

Fig. 6. Surface profiles across the straight line on: a) the copper (Cu-ETP), b) construction steel (08X), c) stainless steel (1H18N9T), d) the heat-resisting steel (H25T)

Colour changes are also observed in the spots. It is suspected that corrosion resistance is decreased in the spot. The spot depth is about $6\ \mu\text{m}$, and the material outflow is about $5\div 6\ \mu\text{m}$ high for copper, construction steel and heat-resistant steel and about $14\ \mu\text{m}$ for stainless steel. The ca. $40\div 65\%$ deeper spots are observed in the areas where lines are crossed (Figs. 5, 6).

The parameter changes have limited influence on the line width. Figures 7 and 8 present the change of line width as a function of the engraving velocity and power. For power change from 4.8 to 8 W with constant engraving velocity and frequency the line width is increased ca. 4%. It is important to notice that using power range from 4.8 to 6.4 for copper the lines are not visible. Increasing power causes also the increase of line width up to $45\ \mu\text{m}$ whereas for 08X steel the line width is ca. 15% increased.

With the change of engraving velocity from 25 to 100 mm/s, the decrease of the line width is noticed, what is shown in the Figure 8.

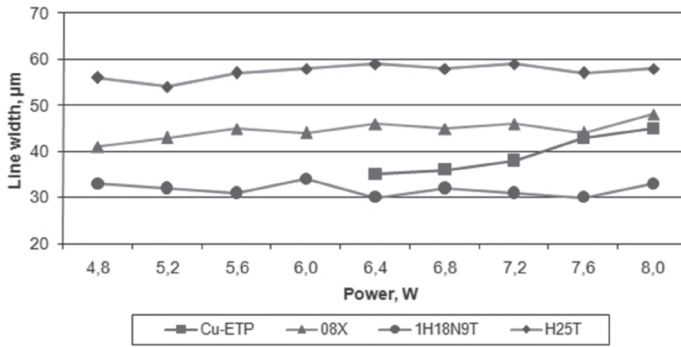

Fig. 7. The line width dependence on the power

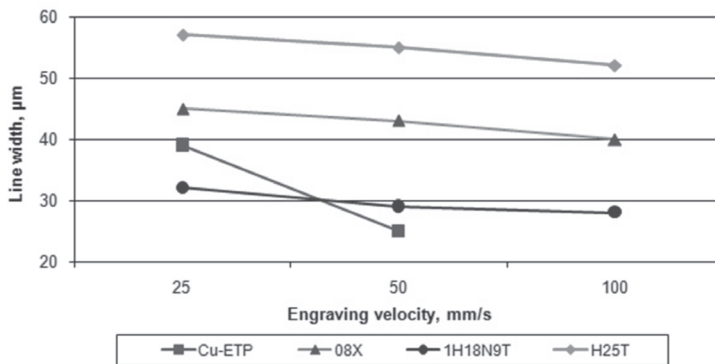

Fig. 8. The line width dependence on engraving velocity

4. Conclusions

Conducted tests of marking metal surface by the laser engraving technique of steering laser beam shows the usefulness of this method for marking steel, which guarantee high quality marks. The stability of the line width, particularly in the vertical direction made it possible to create the signs in the form of bar codes containing the same amount of data which, for example, printed bar codes.

At the same time, the obtained test results indicate, that depending on the physical properties of the material on which markings are made, it is necessary to find an optimal set of parameters including power, engraving velocity and pulse frequency, which guarantees the highest quality and a high efficiency of the process for marking both stationary and a part in motion. Susceptibility to automation and software availability make it easy to control the content of the characters made during the process.

Moreover, in the marks area a decrease of corrosion resistance is noticed. The high contrast and the colour of the engraved lines (dark brown) can limit life time, but considering material outflow it is suspected, that even under the protective coating the marks should be readable using surface analyser device. Such a solution can be useful in the case of parts identification i.e. after an airplane crash.

References

- [1] Qi, J., Wang, K.L., Zhub, Y.M.: *Journal of Materials Processing Technology*, 139 (2003) pp. 273–276
- [2] Ming-Fei, Ch., Wen-Tse, H., Wei-Lun, H., Chun-Wei, H., Yu-Pin, Ch.: *Journal of Materials Processing Technology*, 209 (2009) pp. 737–744
- [3] Kuo, Y.L., Lin, J.: *Optics and Lasers in Engineering*, 46 (2008) pp. 388–395
- [4] Noor, Y.M., Tam, S.C., Lim, L.E.N., Jana, S.: *Journal of Materials Processing Technology*, 42 (1994) pp. 95–133
- [5] Leone, C., Lopresto, V., Delorio, I.: *Optics and Lasers in Engineering*, 47 (2009) pp. 161–168
- [6] Cheng-Jung, L., Yi-Chung, W., Lang-Dong, L., Chyi-Rong, Ch., Ya-Nan, W., Ming-Jer, T.: *Journal of Materials Processing Technology*, 198 (2008) pp. 419–425
- [7] Shin, H.S., Park M.S., Chu C.N.: *CIRP Annals – Manufacturing Technology*, 59 (2008) pp. 585–588