

Thermodynamic simulation comparison of AVL BOOST and Ricardo WAVE for HCCI and SI engines optimisation

The aim of this paper is to compare two simulation software platforms, AVL BOOST™ and Ricardo WAVE™ as used to simulate HCCI and SI GDI engines with the intention of maximising the engine's efficiency and minimising the emissions. This paper compares these platforms in an experimentally validated model to analyse a spark ignition and a Homogeneous Compression Ignition Charge (HCCI) single cylinder 4 valve gasoline engines with multiple configurations and running parameters in order to find the most optimal set-up for the engine, with the prospect of allowing an optimum engine to be built and tested in real world conditions without the need for multiple expensive prototypes and long delays.

Key words: HCCI, SI, numerical simulation, software platforms, AVL BOOST, Ricardo WAVE

1. Introduction

Modern software allows for accurate prediction of engine performance without the need to build a physical model. One-dimensional engine and gas dynamics simulation software packages such as Ricardo WAVE or AVL BOOST are relatively inexpensive tools for the engineering and design of modern engines. Using these programs changes the system of engine development resulting in a process that is far less reliant on building costly prototype engines and allows for various design parameters to be explored and optimised before any prototyping begins, vastly reducing research and development costs for new engine technologies.

This paper investigates the use of modelling software platforms Ricardo WAVE and AVL BOOST to generate a model of a 1-cylinder engine operating under various conditions and to determine the accuracy of the software by comparison with experimental results. The software can then be used to predict improvements that can be made to the model, and reduce the emissions of the engine.

1.1. Aims of the paper

The objectives of this paper are as follows:

Build a model of an existing engine using known geometries and valve timings.

Determine combustion profiles using experimental pressure data to complete the model.

Calibrate and validate the model by comparing the Ricardo WAVE and AVL BOOST model output to existing experimental data.

Change certain engine parameters to investigate and suggest improvements using data from the model.

1.2. Hypothesis

Emission reductions can be achieved by changing the inlet and exhaust valve opening and closing times. As the geometries are kept near identical for all the investigated cases (1 to 7), it is expected that changes due to mode of combustion will be observed. The model will show the advantages of HCCI over SI and is likely to display an improvement in pollution emissions over the SI cases. In this work cases 1-3 refer to HCCI mode, cases 4-7 represent the SI mode.

2. Technical review

2.1. Ricardo WAVE review

Ricardo WAVE™ is an industry standard 1-dimensional engine thermodynamics and gas dynamics simulation software. Ricardo WAVE software is used worldwide in engine industries and enables automotive manufacturers to perform gas simulation on the intake, combustion and exhaust system configurations [1].

2.2. AVL BOOST review

AVL BOOST™ is a very powerful engine and emission modelling software which has fairly intuitive user features. In this study BOOST added-in calculations such as Wiebe functions add a lot of ease to the simulation of combustion. The resulting analysis is useful however its inability to export data to other software such as MS Excel is a downfall. Overall it is on par with Ricardo WAVE; however the lack of user assistance within the program is an issue [2].

3. Ricardo WAVE and AVL BOOST setup

3.1. Spark ignition (SI) engine

A spark ignition engine uses gasoline as a fuel with a stoichiometric gravimetric air-fuel mixture (14.7:1) and spark plugs to initiate the combustion. It works on four strokes; intake, compression, expansion and exhaust.

3.2. Homogeneous charge compression ignition (HCCI) engine

The HCCI engine is a mix between the SI and CI engine; it allows the engine to have high diesel-like efficiency without the need to deal with the expensive removal of NO_x and particulate emissions [3].

The exhaust and inlet were modelled as a combination of orifices, "Y" junctions and ducts in Ricardo WAVE and restriction in AVL BOOST, from the experimental data and junctions, plena and connections in AVL BOOST. The discretisation lengths, heat transfers, temperatures of the piston walls and cylinder were calculated from equations in WAVE Help or from figures used in the tutorials [4]. The fuel Indolene was chosen as it is the closest representation to gasoline that is available in the software. A constant table was created so

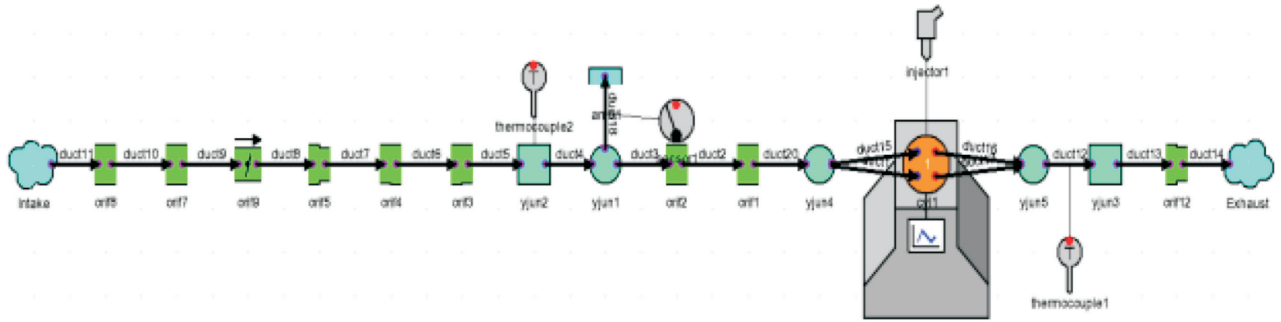

Fig. 1. Ricardo WAVE set up of the SI GDI model

that it is easy to change the variables. The model was set to run for 30 engine cycles to allow for convergence of the results in the simulation. The fuel is directly injected into the cylinder for HCCI and due to the similarity of the intake and exhaust systems the same fuel injector has been used for the SI model, as many Gasoline cars now use direct injection.

The SI engine system as modelled in Ricardo WAVE can be seen in Figure 1 and as modelled in AVL Boost can be seen in Fig. 2. The main difference between the SI model and the HCCI model is that the throttle and the two ducts that are connected to it have been removed and replaced by one duct. The spark timing has been removed as HCCI auto ignites during compression.

3.3 Inputting calculated data to Ricardo WAVE

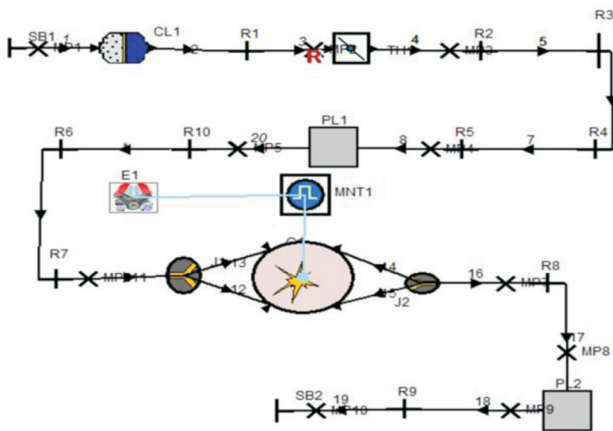

Fig. 2. AVL BOOST set up of the SI GDI model

To calculate the input data for the model from the experimental engine data, first of all the stroke volume was calculated from the bore (90 mm) and the crank offset (88.9 mm). Secondly the clearance volume was calculated by dividing the clearance volume by the compression ratio (11.5:1). Then the clearance height was calculated (8.47 mm). The polytropic constant, k, was calculated by plotting the logarithm of the fired cylinder pressure against the logarithm of the instantaneous volume. The k values were taken from the linear equations on the Excel graph (Figs 3 and 4), the expansion (green line) and compression stroke (red line) are summated and divided by 2 to get an average k value (the instantaneous volume is the clearance volume with the addition of the volume created by the positioning of

the crank). This is a simplified method which nevertheless yields reasonable results.

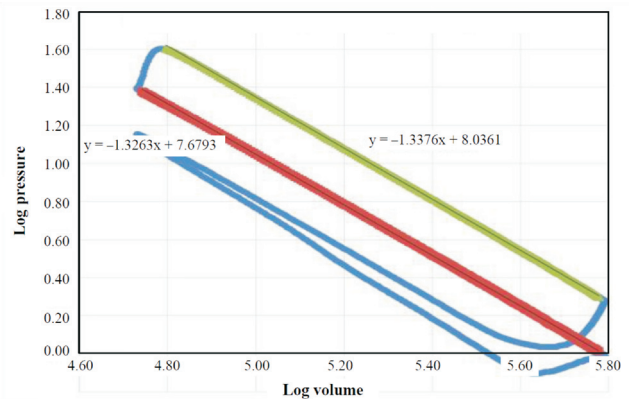

Fig. 3. Log P vs. log V for case 3 (HCCI)

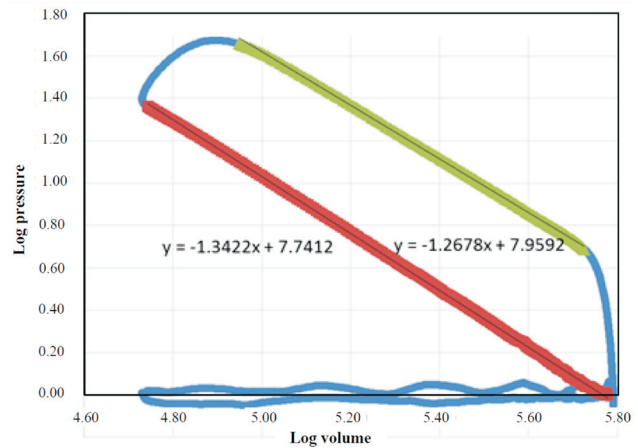

Fig. 4. Log P vs. log V for case 4 (SI)

The k value is then input into equation 1 to calculate the heat release rate (J/deg) for each instantaneous crank angle. Using Equations 2 and 3 the pressure change due to the combustion of the fuel can be calculated. From this the Mass Fraction Burned (MFB) was calculated using Equation 4. The MFB so calculated was plotted against the MFB calculated independently from experimental data. It can be seen from Fig. 4 that the cumulative MFB profile matches both the SI and HCCI models showing the calculations used were correct.

$$Q = \frac{k}{k-1} p \frac{dV}{d\theta} + \frac{1}{k-1} V \frac{dp}{d\theta} \quad [5] \quad (1)$$

$$\Delta p_c = p_{i+1} - p_i \left(\frac{V_i}{V_{i+1}} \right)^k \quad (2)$$

$$\Delta p_c^* = \Delta p_c V_i / V_c \quad (3)$$

$$MFB = \sum_0^i \Delta p_c^* / \sum_0^N \Delta p_c^* \quad (4)$$

Comparing the cumulative mass fraction burned of HCCI mode against SI (Fig. 5) it can be seen that the gradient is much steeper in HCCI hence the fuel is burnt quicker giving a larger pressure increase rate. Also when comparing pressure change (Fig. 6) for SI against HCCI it can be seen that the mass fuel burn duration is shorter for HCCI.

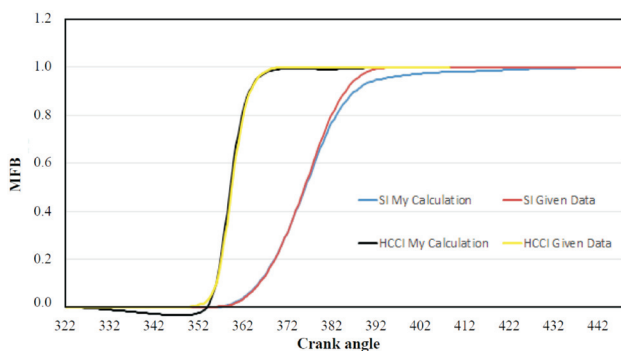

Fig. 5. MFB vs crank angle for case 3 (HCCI) and case 4 (SI)

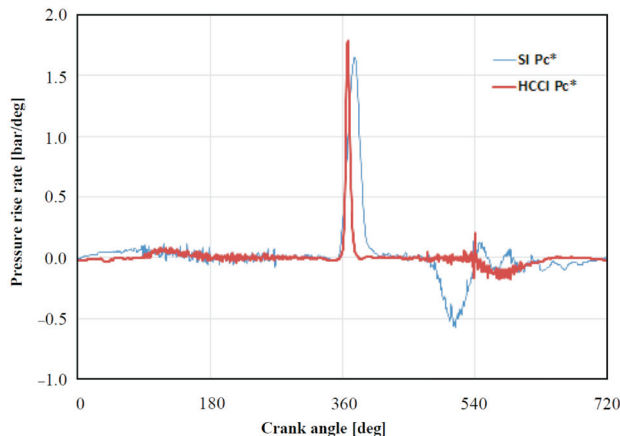

Fig. 6. Rate of pressure rise due to combustion vs crank angle for case 3 (HCCI) and case 4 (SI)

This process has been recalculated case by case for each data set. Their individual polytropic constant k value have been individually calculated from the pressure vs. volume graphs, similarly their mass fraction burned data have been calculated and verified by plotting it on a graph against the experimental data. The cumulative mass fraction burned can now be put into combustion model in WAVE.

3.4 Model calibration and validation in WAVE

3.4.1. SI model calibration

To calibrate the model, after the model has ran, Ricardo WAVE Post has been used to export the pressure vs. CAD

graph into MS Excel. Next the graph was compared against the experimental data by plotting it on the same graph, Figure 7. If the pressure profiles do not trace one another perfectly i.e. the pressure peak is at a different crank angle one would modify the start of combustion till they are aligned. Secondly if the magnitude of the pressure peak is different, one can alter the throttle setting until the magnitude is the same. This calibration is an iterative process where one has to keep exporting the data from WAVE Post and manipulating these parameters until the pressure profile from WAVE traces the profile from the experimental data.

To be better assured that the pressure profiles align, one can use the “.out” file and see exactly at what crank angle the maximum pressure occurred in the data (TH_PMax angle) and compare this against the experimental data. Similarly with comparing the PMax pressure against the pressure magnitude from the experimental data.

To validate this model the next data case set was imported, without changing any model variables other than the throttle and the start of combustion, with the obtained results matching the pressure profiles from the experimental data, hence validating the model.

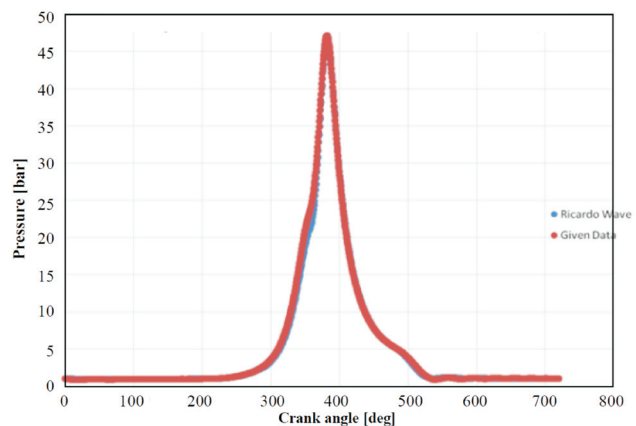

Fig. 7. Pressure from experimental data against the pressure from Ricardo WAVE SI model

3.4.2. HCCI model

To calibrate the model it is imperative to match the crank angle at which the pressure peaked with the pressure peak from the experimental data by modifying the start of combustion. To achieve the same pressure magnitude, as there was no throttle, the heat transfer figures, the head and piston area multipliers were changed. The heat transfer coefficients when the valves were opened and closed were decreased by 33% (from 1.2 to 0.8) and the piston surface multiplier was reduced from 1.6 to 1.5. This was an iterative process. This was exported from WAVE and checked against the experimental data, Figure 8. The pressure magnitude and the crank angle that this occurs at in the first model are exactly as those given in the experimental data, showing that the model is calibrated.

To validate the model the same parameters; heat loss transfers, surface area multipliers etc. are kept constant in the next HCCI cases. For case 2 and 3 the start of combustion is modified to align pressure peak from WAVE with the given

data's pressure peaks crank angle. The cases are exported to Excel and compared against the experimental data, the pressure profiles trace one another for both other cases, hence the model is considered validated. As in the SI case, the ".out" file was used to increase the precision.

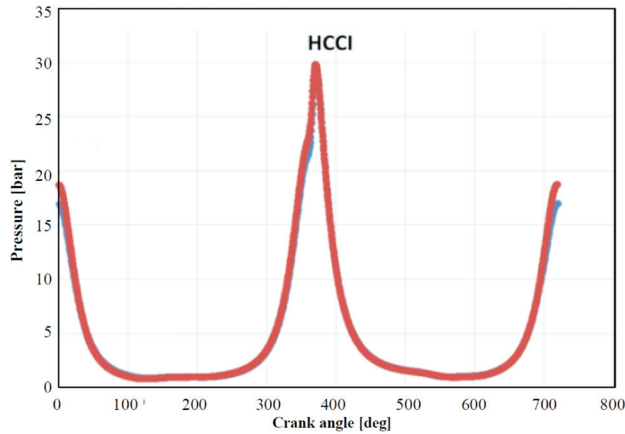

Fig. 8. Pressure from experimental data against the pressure from HCCI model

4. Results and improvements in the engine cycle

4.1. Results

4.1.1. SI

The maximum pressure (PMax (bar)) and the crank angle of maximum pressure (PMax (CAD)) occur at exactly the same pressure and crank angle as the experimental data, this gave an IMEP value with an accuracy of + 4.2% for the 4 models experimental data, validating the SI model. For the SI and HCCI cases the PMax (CAD), PMax (bar) and IMEP (bar) values are shown in Table 1.

Table 1. Experimental data (Given) vs. Ricardo WAVE and AVL BOOST models data

	Case number.	Data source	IMEP [bar]	PMax [bar]	PMax CAD [deg]
HCCI	Case 1	Given	1.81	29.82	371.00
		Boost	2.60	29.74	11.00
		Wave	2.00	29.68	11.00
	Case 2	Given	2.80	38.32	369.50
		Boost	3.27	38.08	9.50
		Wave	2.91	37.91	9.50
	Case 3	Given	3.48	40.25	372.00
		Wave	3.70	40.26	12.00
	SI	Case 4	Given	10.04	47.19
Boost			9.42	40.32	22.00
Wave			10.24	47.19	22.00
Case 5		Given	1.73	14.86	372.50
		Boost	1.58	14.64	12.50
		Wave	1.66	14.86	12.50
Case 6		Given	2.58	21.13	371.50
		Wave	2.58	21.13	11.50
Case 7		Given	3.25	27.62	369.50
		Wave	3.25	27.62	9.5

4.1.2. HCCI

The pressure (PMax (bar)) and the crank angle (PMax (CAD)) are exactly the same as the given data and the IMEP is within +10%, validating the model.

4.2. Emissions improvements predicted by Ricardo WAVE model

To increase the efficiency of the engine several parameters can be changed; firstly the compression ratio can be increased. To allow for the extra compression it is advised to use a higher octane fuel as the engine can develop knocking if combustion does not happen at the optimum piston position [6]. Secondly having the injection timings as a variable rather than at a fixed point would allow to manipulate when the combustion cycle starts, this could lead to more power being produced and to reduced emissions.

For the 2 cases, SI and HCCI, one of the parameters has been changed (EVO, IVO, air fuel ratio, fuel type and engine speed) and compared to a validated model, to see the effect it would have on the emissions, as calculated in the software platform models. This is discussed below in more detail for the 2 models.

4.2.1. SI engine

Case 7 was chosen as all the IMEP, PMax (CAD) and PMax (bar) are the same as the given data. The largest decrease in predicted emissions was caused by changing the fuel type from Indolene to Ethanol, reducing the NO_x by 96%, HC by 41% and the CO by 100%. Advancing the inlet valve 5 deg CA and retarding the exhaust by 5 deg CA (increasing the valve overlap) decreased the emissions; this can be seen in Table 2.

Table 2. Predicted reduction in emission for the SI model in Ricardo WAVE

	EVO (+5°)	IVO (-5°)	Ethanol
NO _x [ppm]	-12%	-11%	-96%
HC [ppm]	-2%	-2%	-41%
CO [ppm]	-24%	-15%	-100%

4.2.2. HCCI engine

The type of fuel could be changed so that it does not contain any aromatic hydrocarbons such as biofuel. This would decrease the particulate emissions as aromatic HC's are difficult to burn. Also due to the higher octane number of biogas it would allow a higher compression ratio resulting in a higher thermal efficiency.

Advancing the inlet valve, retarding the exhaust and changing the fuel to ethanol improved the emissions as shown in Table 3.

Table 3. Reduction in predicted emissions for the HCCI model in Ricardo WAVE

	IVO (-20°)	EVO (+20°)	Ethanol
NO _x [ppm]	-18%	-2%	-86%
HC [ppm]	-25%	-4%	-44%
CO [ppm]	-12%	-1%	-94%

5. Comparison of WAVE and BOOST

5.1. Ricardo WAVE™

Ricardo WAVE™ seems easier to learn, provides fully understandable help and tutorials, easier troubleshooting when there is an error in the result and less data is required to get the model running in the first place.

5.2. AVL BOOST™

This platform provides possibility to do more complicated and advanced engine simulation in terms of engine design and cycle simulations, beneficial possibility of performing co-simulation with other simulation software and possibility of relatively easy implementation of user-defined models and algorithms.

6. Conclusion

To conclude, the two engines have been modelled successfully both in Ricardo WAVE and AVL BOOST and have been validated by calibrating the initial model and tuning the following cases to match the given data from experiments

with good levels of accuracy. All models could be used to easily predict improved emissions.

Both software platforms give a good representation of a 1D cylinder, the results for the SI and the HCCI engine have given exact pressure magnitudes and the crank angles that they occur at when compared to the experimental data, with the IMEP value being within +10% of the given data. The reasons for the software not producing exactly the same results as the model are due to factors such as the fact that the software does not provide predictive means of modelling combustion or take into account the 3d turbulence that would be occurring in the cylinder, also the heat loss values are not necessarily the same as in an actual engine.

Whilst using AVL BOOST it has been a more difficult program to use, the error messages are counter intuitive to fix and it is time consuming to produce initial working models. However when a working model is obtained, it is easy to change the variables as they are all in one constant table.

The main benefit of using 1d software is that the calculations are fast.

Nomenclature

CI Compression ignition
EVO Exhaust valve open
HCCI Homogenous charge compression ignition
IMEP Indicated mean effective pressure

IVO Intake valve open
MFB Mass fraction burned
SI Spark ignition
TDC Top dead centre

Bibliography

- [1] Ricardo plc. 2014. Ricardo Software, www.ricardo.com/Page-Files/864/WAVE%20Flyer%20A4_4PP.pdf
- [2] AVL BOOST plc. 2013. AVL Software, www.avl.com/BOOST
- [3] alternativefuels.about.com/od/researchdevelopment/a/HCCI-basics.htm
- [4] Ricardo plc. 2013. WAVE 2013 Help System.
- [5] Stone R. Introduction to internal combustion engines. 3rd ed. Basingstoke: Macmillan 1999.
- [6] auto.howstuffworks.com/compression-ratio-fuel-economy.htm

Ali AlQahtani, MEng. – Research Student in the School of Mechanical Engineering at University of Birmingham.
e-mail: AMA374@bham.ac.uk



Farzad Shokrollah Hassanbarough, MEng. – Research Student in the School of Mechanical Engineering at University of Birmingham.
e-mail: fxs931@bham.ac.uk



Mirosław L. Wyszynski, MEng, PhD, MIDGTE, MSAE, MSIMP – Professor in the School of Mechanical Engineering at University of Birmingham.
e-mail: m.l.wyszynski@bham.ac.uk

