

Departamento de Ingeniería Textil y Papelera,

\*Instituto de Investigación Textil y Cooperación Industrial de Terrassa, Universitat Politècnica de Catalunya. Colom, 11. 08222-Terrassa. Spain

\*\*Departamento de Óptica y Optometría, Universitat Politècnica de Catalunya. Violinista Vellsolà, 37. 08222 Terrassa. Spain

E-mail: carrera@catunesco.upc.edu

## Abstract

The usefulness of the fractal dimension of drape ( $D$ ) to explain the shape of fabrics acquired when allowed to fall freely under the effect of gravity was assessed by using the box-counting method to calculate it for comparison with the drape ratio (%DR) of 36 commercial woven fabrics spanning a wide range of composition, weave type and mass per square meter. These two parameters were found to be highly correlated with %DR, varying over wide ranges and  $D$  over narrow ranges. Based on the results, the fractal nature of the drape does not significantly improve on the information about the drape shape in woven fabrics provided by the well-known indicator "drape ratio" (%DR).

**Key words:** drape, box-counting, fractal dimension, fabric.

ence of the specimen area and disc area [1] (see **Figure 2**).

$$\%DR = \frac{A - B}{C - B} \quad (1)$$

where,  $A$  - specimen shade area,  $B$  - supporting disc area,  $C$  - specimen area.

The advent of digital electronics has allowed the human eye to be replaced by digital cameras capable of accurately capturing the shadow projected by fabric drape on Cusick drape meters. The ability to process the information thus obtained with imaging techniques has enabled the use of very powerful mathematical techniques to characterise the geometry of drape projections [2 – 14].

Ever since the first equipment for assessing fabric drape was devised in the mid XX century [15], textile researchers have proposed up to 34 different indices and indicators to quantify this property, most of which have scarcely improved on previously existing measures of drape [16]. Drape indices and indicators can be classified into five broad categories, namely:

a) *Area and perimeter based measures.*

Drape is calculated from the area of the shadow projected by a specimen, which is either measured directly or estimated from the equivalent circle corresponding to the radius and/or perimeter length of the area.

b) *Radius based measures.* Drape is determined by measuring the radii of different sections of the drape-projected shadow (e.g. the mean radius, the radius of the equivalent circumference, the radial distance ratio or its variance). These measures provide estimates of circularity in drape shape.

c) *Fold based measures.* Drape is calculated from some fold property such as

the number, depth, dimension (width, height), distribution or regularity.

d) *Profile based measures.* These are based on characteristics of the drape profile (severity, slimness, symmetry) as determined by using appropriate mathematical tools such as the Fourier series, fractals, etc.

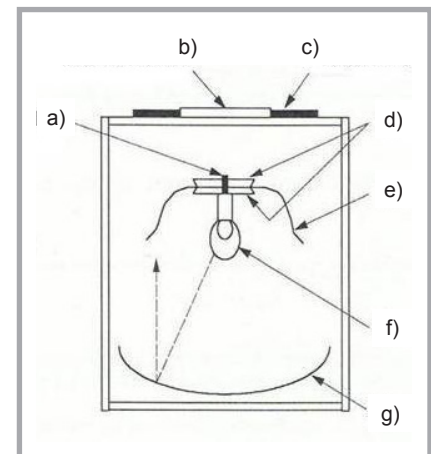

**Figure 1.** Typical Cusick drape meter; a) specimen fixing needle, b) central disc lid, c) paper ring, d) specimen support discs, e) fabric specimen, f) spot light, g) parabolic mirror.

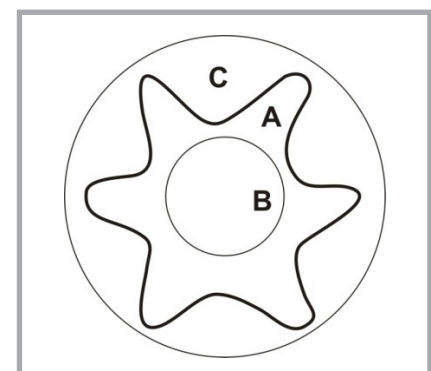

**Figure 2.** Area of (A) specimen shade, (B) supporting disc (C) unfallen specimen.

## Introduction

The drape shape continues to be widely assessed by using a Cusick drape meter [1]. The meter uses a circular specimen 30 cm in diameter that is positioned horizontally on a rigid metal disc 18 cm in diameter. The fabric portion not resting on the disk falls freely as a function of the drape. A light source aligned with the focus of a parabolic mirror is placed below the centre of the circular specimen to project light downwards. The light beam is reflected back by the mirror and impinges on the fabric specimen to project its shade on a paper ring parallel to the fabric above it. **Figure 1** depicts a typical drape meter.

The drape ratio (%DR) of a fabric is defined as the ratio of the difference between the area projected by the fabric and that of the supporting disc to the differ-

e) *Three-dimensionally simulated measures.* The interest of designers and graphical computation researchers in simulating fabric drape three-dimensionally has led to the development of tools for measuring specific drape geometry parameters, such as the drape angle, to facilitate the three-dimensional interpretation of drape.

The indicator most widely used is the drape ratio, which allows an objective, albeit incomplete, description of the drape shape. Thus a low %DR value is typical of an easily deformed fabric with a high drape, whereas a high %DR value reflects low deformation and, hence, also low drape.

However, this index cannot fully explain the complex three-dimensional aspect of drape. In fact, as can be seen from *Figure 4*, fabrics with an identical drape ratio can differ considerably in drape shape. One should bear in mind that the test measures a three-dimensional property that is subsequently reduced to a two-dimensional property: projection of the drape shape on a plane.

The high potential of imaging techniques was used in 2011 to develop a novel approach to the characterisation of fabric drape based on the fractal dimension [17]. The new approach was intended to exploit the power of fractal analysis techniques to examine curve profiles and its ability to recognise patterns. Originally fractal dimensions were calculated for only three different types of woven fabrics using the box-counting method [18]. Based on the results, the new index provided more information about the shape of the drape curve than did the widely known drape ratio (%DR).

The primary purpose of this work was to assess the effectiveness of the box-counting method for characterising the shape of drape profiles and identify any aspects the drape ratio cannot discriminate accurately enough. To this end, we calculated the %DR and fractal dimension for 36 different commercial woven fabrics, spanning a wide range of composition, weave type and mass per square meter.

### ■ The box-counting method

A fractal is a geometric object, the basic, fragmented or uneven structure of which is repeated at different scales. Fractals are invariant under a change of observa-

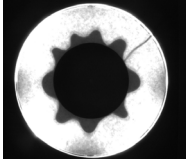
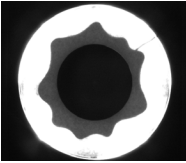
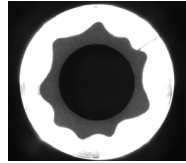
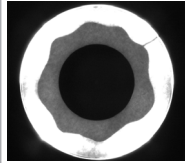
Image				
%DR	25.07	45.01	55.90	73.33

*Figure 3.* Drape profiles of four fabrics differing in drape ratio.

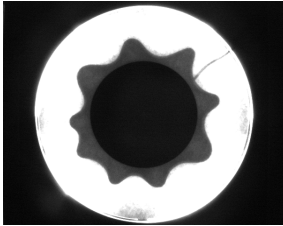
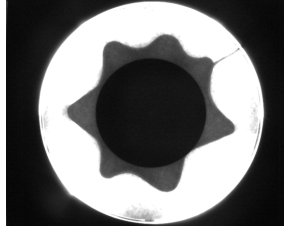
Ref	A	B
Image		
%DR	39.52	39.70
Fold number	9	7

*Figure 4.* Two fabrics with an identical drape ratio can differ in drape profile.

tion scale and self-affine. Their shape is quantified in terms of the so-called “fractal dimension”, which is a measure of unevenness [19].

The box-counting method scales a segment, square or cube of length 1 by a factor and fills the resulting figure with similar figures  $N(\varepsilon)$  according to the following power law:

$$N(\varepsilon) = (1/\varepsilon)^D \quad (2)$$

where, exponent  $D$  is the dimensionality of the figure concerned (1 for a segment,

2 for a square and 3 for a cube). For all classical geometric figures,  $D$  is a whole number.

The previous law is applicable to figures with auto-similar structures (i.e. figures obtained by replicating an architectural pattern, which will obviously have identical representations on smaller or larger scales). Such figures are known as “fractals” and have a dimension  $D$ , given by the following power law:

$$D = \ln(\varepsilon)/\ln(1/\varepsilon) \quad (3)$$

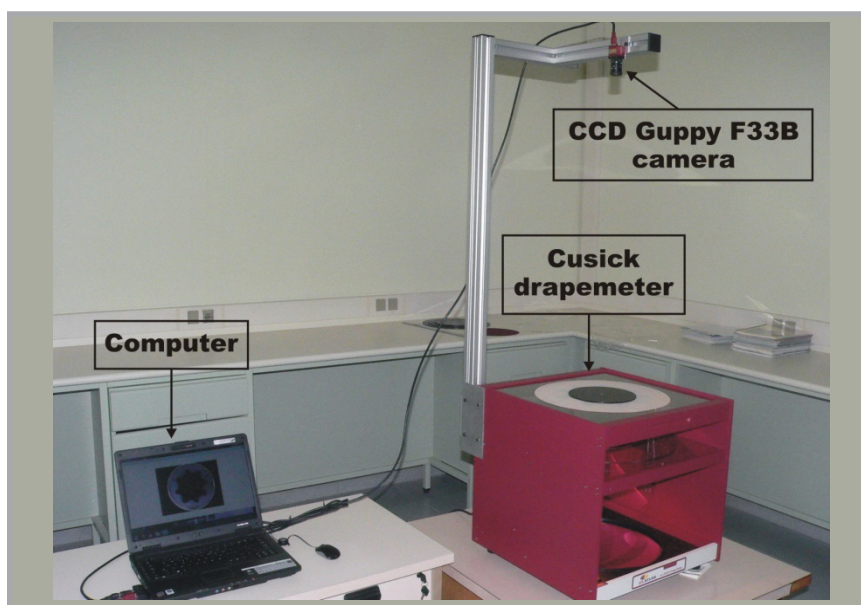

*Figure 5.* Digital drape meter used.

**Table 1.** Composition, weave, mass per square meter, drape ratio (%DR) and fractal dimension (*D*) of the woven fabrics studied, shown in descending order of the mass per square meter.

Ref.	Composition (%)	Weave	Mass per square meter, g/m <sup>2</sup>	%DR	D
1	WO/PAN 60/40	Double cloth	447.4	64.76	1.725
2	PES/CV/EA 64/31/5		371.4	50.73	1.703
3	PES/CV/EA 78/18/4	Serge	341.3	38.13	1.680
4	WO/PA 90/10	Double cloth	333.3	64.77	1.725
5	CO/WO/PA 76/19/5	Two-sided cloth	309.1	67.67	1.729
6	WO 100%	Satin	299.4	42.66	1.689
7	PES/CV/EA 78/17/5	Herring bone	279.1	30.42	1.682
8	CO 100%	Matt	241.2	65.42	1.726
9	WO/EA 99/1	Crepe	232.2	37.35	1.678
10	PES/CV/EA 65/31/4	Taffeta	221.2	31.06	1.664
11	CO 100%	Herring bone	214.0	57.97	1.714
12	WO 100%	Serge	209.0	53.08	1.706
13	WO/PES 60/40	Herring bone	199.1	47.30	1.697
14	WO 100%	Serge	191.1	44.84	1.693
15	LI 100%	Taffeta	186.9	57.86	1.715
16	PES 100%	Serge	172.6	25.85	1.654
17	CV/WO/PES 43/34/24	Taffeta	171.2	32.58	1.668
18	CO 100%	Serge	169.5	45.78	1.693
19	PES/LI 55/45		163.6	57.86	1.715
20	WO/LI/CO/PA 36/32/16/16		157.7	49.62	1.700
21	CO/PES 65/35	Herring bone	135.2	62.06	1.721
22	CO/PES	Taffeta	90.0	55.15	1.710
23	PES 100%	Satin	90.0	59.38	1.717
24	PES/CV		90.0	66.54	1.729
25	CV/CA 55/45	Serge	80.0	40.04	1.684
26	PES 100%	Satin	78.4	57.19	1.713
27	CV/PES	Jacquard	77.5	60.43	1.718
28	PES 100%	Serge	76.5	68.75	1.731
29	CV 100%		72.0	41.25	1.684
30			Taffeta	70.0	40.60
31	CV/PES	Serge	70.0	57.09	1.713
32		68.5	54.20	1.708	
33	CA 100%	Taffeta	68.0	42.33	1.690
34	PES/CV		65.0	52.55	1.705
35	PES/CV 50/50	Serge	65.0	50.08	1.703
36	PES 100%	Taffeta	50.0	58.60	1.716

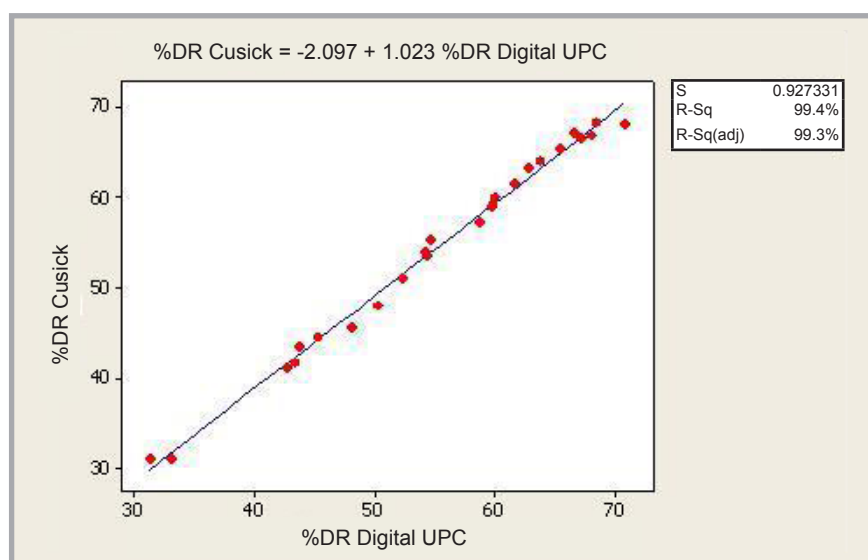

**Figure 6.** Regression between %DR values as obtained with the conventional method and UPC digital method.

The method most widely used for estimating fractal dimensions is the box-counting method [17, 19, 20]. A grid of cell length  $\epsilon$  is superimposed on the target figure and the number of cells (boxes) spanned by the figure counted. Then the count is repeated for other cell sizes ( $\epsilon$ ). The fractal dimension,  $D$ , is calculated from the slope of a regression plot of  $\ln N(\epsilon)$  vs  $\ln(1/\epsilon)$ :

$$\ln N(\epsilon) = \ln K + D \ln(1/\epsilon) \quad (4)$$

Additional parameters used to characterise the drape shape include the correlation dimension - which, together with the box-counting dimension, is the most widely used by virtue of its easy determination -, the Hausdorff dimension - which is the most important in theoretical terms -, the Rényi dimension, and the information dimension. Although the box-counting fractal dimension is typically designated by  $D_C$  to distinguish it from the previous alternatives, we have omitted the subscript throughout this paper because it was the only type of dimension examined here.

## Materials and methods

We studied a total of 36 commercial drapery, shirtmaking and woven lining fabrics, spanning a broad range of composition, weave type and mass per square meter (see **Table 1**). The fabrics were examined by using a UPC digital drape meter developed by the authors. The experimental set-up comprised a conventional Cusick SDL ATLAS drape meter fitted with a Guppy F33B AVT ultracompact monochrome digital camera from Allied Vision at the top.

The camera, which uses a Sony ICX424 CCD sensor, was interfaced to a computer for image acquisition and analysis (see **Figure 1**). Prior to use, the camera was calibrated as per the manufacturer's instructions to calculate the number of pixels per square centimetre captured in each image, and also to correct optical distortions and misalignment.

Images were acquired with the software Sherlock™, which uses its own programming language for measurements and calculations. The procedure for determining the parameters used to characterize drape geometry with the UPC digital drape meter involves the following sequence: a greyscale digital image of

the drape shadow is captured and converted into a monochrome (binary) image by filtering noise at the threshold, and then the software uses imaging analysis to determine the target geometry parameters.

Each fabric was used to obtain 4 randomly cut specimens that were allowed to adjust to the laboratory environmental conditions prior to measurement (3 times on the face and another three on the reverse). The result for each fabric was thus the average of 24 determinations. All tests were performed at the Textile Physics Laboratory of the Department of Textile and Paper Engineering of the Polytechnical University of Catalonia (UPC).

The fractal dimension for each drape image (24 images per fabric) was calculated by using software for drape profile analysis developed by the authors in MATLAB.

### Results and discussion

The correlation between the digitally determined %DR values obtained as described above and the conventional measure as obtained by cutting and weighing the paper area containing each drape projection (BS 5058,1973) was very high (99.4%, **Figure 6**).

As can be seen, %DR and D were highly correlated (99.2%). Also, as can be seen

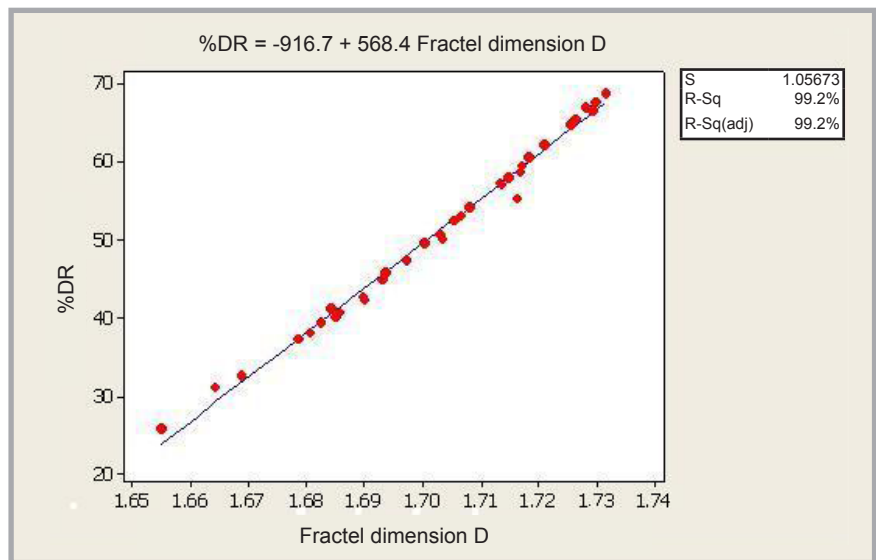

**Figure 7.** Regression between the drape ratio (%DR) and fractal dimension (D) in the fabrics.

from **Figures 7** and **8**, D decreased with the increasing roughness of the drape profile.

The fact that %DR and D were so highly directly correlated suggests that the fractal dimension of the drape profile provides no additional information or allows the shape of the drape profile to be more accurately characterised than by using %DR. Also D values were slightly staggered. Thus the differences in drape profile between the fabrics resulted in no substantial differences in D (see **Figures 8** and **9**, see page 70).

### Conclusions

The results obtained in this work allow the following conclusions to be drawn:

- The drape profile of a fabric as determined with a Cusick drape meter is a fractal dimension because the calculated D value provided by the box-counting method exceeds its topological dimension: unity. In fact, D for the fabrics studied here ranged from 1.651 to 1.737.
- D and %DR were highly correlated (99.2%). Roughness in the drape profile increased with the decreasing fractal dimension and vice versa:

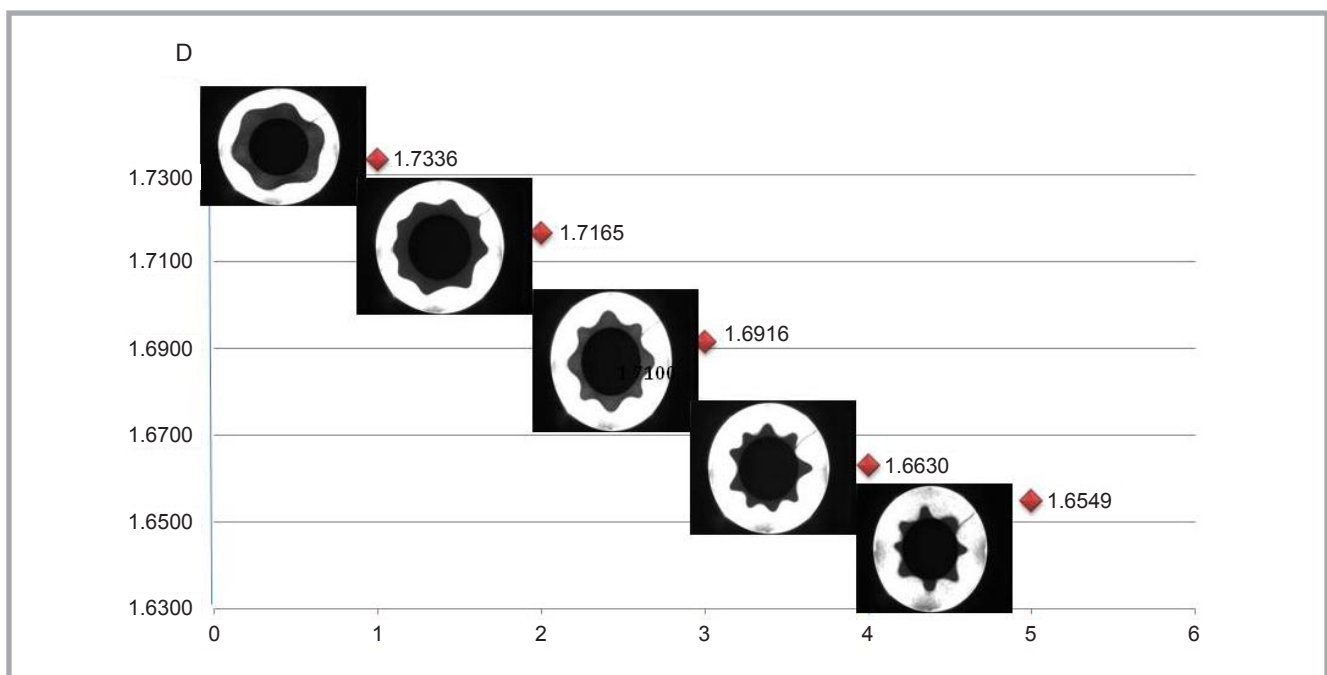

**Figure 8.** Variation in the fractal dimension (D) and roughness of drape shape.

Ref.	1	2	3
Image			
D	1.734	1.734	1.730
%DR	71.36	69.96	68.17

Figure 9. Drape shape, fractal dimension and drape ratio for three selected fabrics.

- the greater  $D$  was, the smoother was the profile.
- c) The drape ratio for the fabrics ranged from 71.359 to 24.877 and their fractal dimension from 1.733 to 1.654. Whereas drape profiles differed markedly between fabrics,  $D$  values did not.
- d) The fractal dimension calculated with the box-counting method is not sensitive enough to detect differences in the drape profile shape. This is a result of profile roughness being variable as a result of the distance between any two points in the profile being a finite number.

## References

- Cusick GE. The Measurement of Fabric Drape. *Journal of the Textile Institute* 1968; 59, 6: 253–260.
- Stylios, G. K., Zhu, R. The Characterisation of the Static and Dynamic Drape of Fabrics. *Journal of the Textile Institute* 1997; 88, 4: 465–475.
- Jeong YJ. A Study of Fabric-Drape Behaviour with Image Analysis Part I: Measurement, Characterisation, and Instability. *Journal of the Textile Institute* 1998; 89, 1: 59–69.
- Stylios GK, Wan TR. The concept of virtual measurement 3D fabric drapeability. *International Journal of Clothing Science and Technology* 1999; 11, 1: 10–18.
- Robson D, Long CC. Drape Analysis using Image Techniques. *Clothing and Textiles Research Journal* 2000; 18, 1: 1–8.
- May-Plumlee T, Eischen J, Kenkare N, Pandurangan P. *Evaluating 3D Drape Simulations: Methods and Metrics*. Edinburgh ed., 22–24 September, 2003.
- Jevsnik S, Gersak J. Modelling the Fused Panel for a Numeric Simulation of Drape. *Fibres & Textiles in Eastern Europe* 2004; 12: 47–52.
- Park CK, Kim S, Yu WR. Quantitative Fabric Drape Evaluation System Using Image Processing Technology (Part 1: Measurement System and Geometric Model). *Journal of Testing Evaluation* 2004; 32, 2: 131–137.
- Sharma KS, Behera BK, Roedel H, Schenk A. Effect of sewing and fusing of interlining on drape behaviour of suiting fabrics. *International Journal of Clothing Science and Technology* 2005; 17, 2: 75–90.
- Mizutani C, Amano T, Sakaguchi Y. A New Apparatus for the Study of Fabric Drape. *Textile Research Journal* 2005; 75, 1: 81–87.
- Jevsnik S, Zunic-Lojen D. Drape Behaviour of Seamed Fabrics. *Fibers and Polymers* 2007; 8, 5: 550–557.
- Behera BK, Pattanayak AK. Measurement and modelling of drape using digital Image processing. *Indian Journal of Fibre & Textile Research* 2008; 33: 230–238.
- Al-Gaadi B, Göktepe F, Halász M. A new method in fabric drape measurement and analysis of the drape formation process. *Textile Research Journal* 2012; 82, 5: 502–512.
- Sanad R, Cassidy T, Cheung V, Evans E. Fabric and Garment Drape Measurement –Part 2. *Journal of Fiber Bioengineering and Informatics* 2013; 6, 1: 1–22.
- Chu CC, Cummings CL, Teixeira NA. Mechanics of Elastic Performance of Textile Materials. Part V: A Study of the Factors Affecting the Drape of Fabrics. the Development of a Drape Meter. *Textile Research Journal* 1950; 20: 539–548.
- Carrera E. Nuevas perspectivas para la evaluación del cayente de los tejidos de calada. PhD Thesis. Universitat Politècnica de Catalunya, 2014. <http://upcommons.upc.edu/handle/10803/144659>
- Payvandy P. *Evaluation of Fabric Drape Using Image Processing and Fractal Dimension*. In: The 7<sup>th</sup> Iranian Conference on Machine Vision and Image Processing (MVIP). Iran University of Science and Technology, 16–17 November, 2011.
- Payvandy P, Yousefzadeh-Chimeh M, Latifi M. A Note on Neurofractal-based Defect Recognition and Classification in Nonwoven Web Images. *Journal of The Textile Institute* 2010; 101, 1: 46–51.
- Mandelbrot BB. *The Fractal Geometry of Nature*. Ed. Freeman WH, New York, 1982, p. 521.
- Barton C, La Pointe PR. *Fractal in Earth Sciences*. Ed. Plenum Press, New York, 1995, pp. 265.

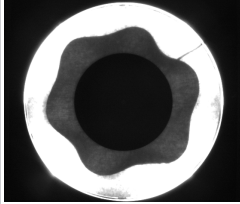
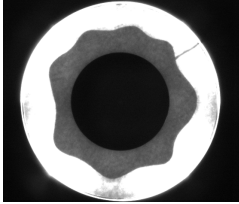
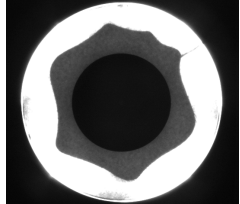
Received 09.09.2013 Reviewed 24.03.2015

## XXI Seminar on ‘New Aspects of the Chemistry and Applications of Chitin and Its Derivatives’

### INVITATION

On behalf of the Board of the Polish Chitin Society I have both a pleasure and an honour to invite you to participate in the **XXI Seminar on “New Aspects of the Chemistry and Applications of Chitin and Its Derivatives”** which will be held in **Szczecin, Poland, September 16<sup>th</sup> – 18<sup>th</sup>, 2015**.

The aim of the conference is to present the results of recent research, development and applications of chitin and chitosan.

It is also our intention to give the conference participants working in different fields an opportunity to meet and exchange their experiences in a relaxing environment.

Best regards  
Malgorzata M. Jaworska  
Ph.D., D.Sc., Eng.

For more information please contact:

CONFERENCE SECRETARY  
M. Skłodowskiej-Curie 19/27,  
90-570 Łódź, Poland  
tel. (+48) 42 638 03 339,  
fax (+48) 42 637 62 14,  
e-mail: ptchit@ibwch.lodz.pl  
[www.ptchit.lodz.pl](http://www.ptchit.lodz.pl)