

SIMULATION RESEARCH OF THE HYDRAULIC DRIVE FOR VALVES OF INTERNAL COMBUSTION ENGINE

Tomasz Szydłowski, Mariusz Smoczyński

Technical University of Lodz, Department of Mechanical Engineering
Zeromskiego Street 116, 90-924 Lodz, Poland

Tel.: +48 42 6312395, +48 42 6312390, fax: +48 42 6312398

email: tomasz.szydowski@p.lodz.pl, mariusz.smoczynski@p.lodz.pl

Abstract

This paper describes simulation research of single-acting hydraulic drive for valves of internal combustion engines. The proposed drive was composed of commercial servovalve and typical hydraulic single-acting actuator. Research was performed for the prepared and verified model of this drive. In the paper mainly analysed was the impact of control signals on course of valve lift and its characteristic parameters like: delay of start of valve movement in opposition to the start of the control signal, the time of opening and closing of the valve, the valve lifting time, the course of valve lift, fill factor of the area under the valve lift curve and velocity of the valve subsidence. Special attention was given to the closing movement of the valve. Drive control was limited to step control signal. In the final phase of closing the valve, the control method had to slow down and stop the valve, but without a significant influence on the valve closing phase. During research the fill factor of the area under the valve lift curve was calculated and compared with values obtained for the classic drive with cam. A number of simulations allowed to determine the optimal control signal for the course with deceleration of the valve. Based on simulation studies it was found that comparable fill factors of the area under the valve lift curve for cam drive and analyzed electrohydraulic drive were obtained up to over 4000 rpm speed. Above this speed the factor was significantly smaller for hydraulic drive. For low engine speeds the values of factor were acceptable and amounted to about 0.7. Unfortunately for the valve opening times for engine speed 6000 rpm, tested drive did not provide the full opening of the valve and the fill factor of the area under the valve lift curve was unsatisfactory. In this research, the frequency characteristics of the servovalve published by their manufacturers were used. It demonstrated that because of the delay and response speed of the valve is necessary to use units generating a control signal ahead in relation to the desired moment of opening the valve.

Keywords: camless engine, hydraulic actuator, internal combustion engine, servovalve

1. Introduction

Hydraulic drive of an internal combustion engine valve should provide a waveform of valve lift with no smaller section in time than obtained for a mechanical cam. Fig. 1 shows waveforms of valve lift driven by a harmonic cam, for engine speeds from 600 to 6000 rpm. For lifting of the valve corresponding with 248° rotation of crankshaft the valve lifting time varies from 7 to 70 ms. Thus, for the largest assumed engine speeds hydraulic drive of valve should ensure the valve opening and valve closing times of about 3 ms.

From the point of view of good filling engine, it would be good if the course of valve lift hydraulically corresponded broadly to the theoretical waveform of a trapezoid ABCD (Fig. 2) with the greatest possible surface area beneath it. The ideal would be if such a waveform was possible to achieve for the largest range of the engine speed.

2. Structure and operations of electrohydraulic single-acting valve drive

Described waveform of valve lift shown in Fig. 2 can be realized by hydraulic drives both single and double action. Fig. 3 shows diagram of the hydraulic drive with valve and valve spring. This drive is the single-acting drive. It consists of hydraulic distributor and hydraulic actuator. Between the engine valve 5 and the piston 3 there is the valve spring 4, which is responsible for

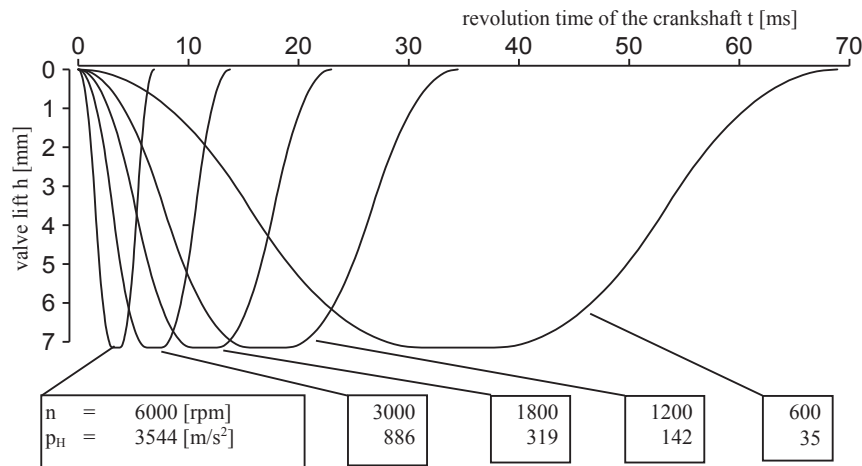

Fig. 1. Waveforms of valve lift driven by a harmonic cam, for engine speeds from 600 to 6000 rpm

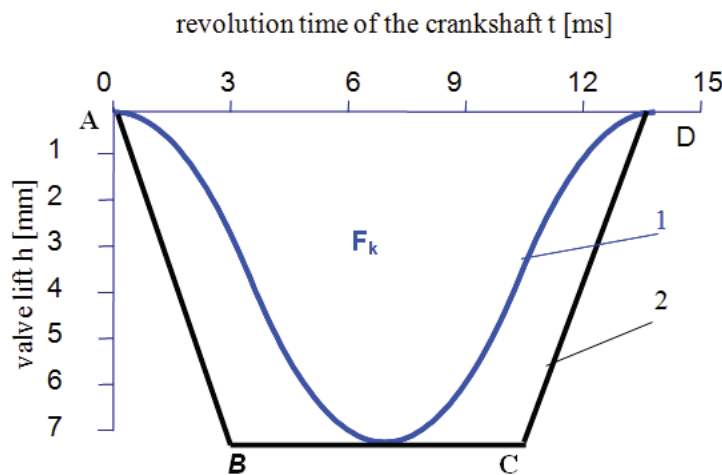

Fig. 2. Waveforms of valve lift for engine speeds 3000 rpm: 1 – the real waveform of valve lift mechanically driven by a harmonic cam, 2 – theoretic, desired waveform of valve lift hydraulically driven

closing the valve and maintains it in the closed position, providing a leak-proof of the valve seat. Current in the electromagnet coil is the control signal forcing the movement of the valve. The engine oil is the working medium, which causes displacement of the piston to the bottom, and thus moves the engine valve. This oil flows into the space above the piston through oil channel O_2 , from supply channel O_1 after turning on the current in the coil of the electromagnet 2 – Fig. 3b. Then slide of the distributor is moved to the right side and opens the gap, through which the oil flows from the supply channel O_1 to channel O_2 . When changing the direction of current flow in the windings of the electromagnet, slider 1 moves to the left to its initial position, causing closure of the supply channel O_1 and the opening of the return channel O_3 . The oil now flows from the oil space above piston 3, causing suddenly reduction of the pressure. This reduction of the oil pressure above the piston of the cylinder in combination with the force of the valve spring 4 moves the piston up, and closes the engine valve 5 (Fig. 3a).

In this paper, the properties of such a drive were discussed. The basis for their determination are results of simulation research carried out with the model of the single-acting hydraulic drive for engine valve, given below. Verification of the model was made with use of the research stand with specially designed hydraulic valve drive composed of: the typical valve of high-speed engine, commercial hydraulic actuator and Rexroth servovalve controlling the flow of the working fluid to and from the actuator [8]. The detailed structure and principle of operation of the drive were also described in [8].

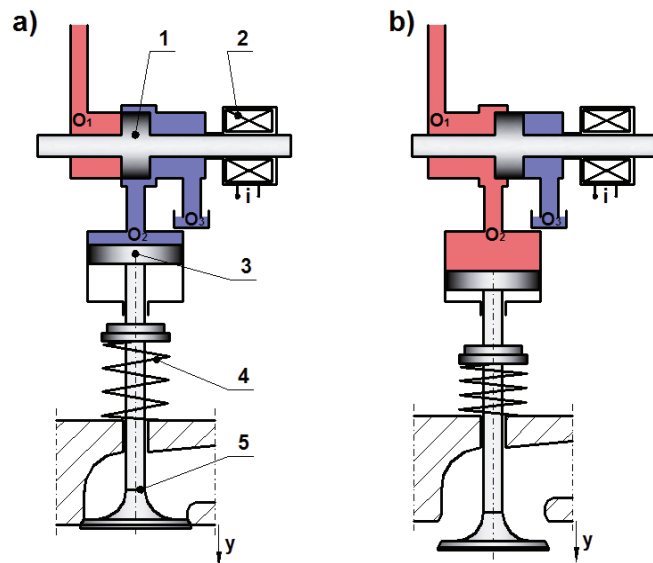

Fig. 3. The diagram of single-acting hydraulic drive: 1 – slider of electrovalve, 2 – electromagnet coil, 3 – piston of the actuator, 4 – actuator piston spring (valve spring), 5 – valve, O_1 , O_2 , O_3 – oil channels

3. Simulation studies results

Simulation studies electrohydraulic valve drive were performed for servovalve parameters corresponding to the settings (characteristics) factory. In the first stage of simulation tests examined the impact of control method on valve lift waveforms.

Prior to testing, the following assumptions were made:

- opening of the valve will last as short as possible,
- final phase of valve closing aim to slow down the valve speed, so that eventually it will shut down with as low speed as possible but without a significant extension of the whole closing phase,
- drive control will be limited to step signal. This means that the controller can only change the duration of the bipolar signal depending on the angular velocity of the engine crankshaft.

Considering the control of the electrohydraulic drive one must take into account several important issues. First of all, start of movement of the valve is significantly delayed in opposition to the control signal, which results from the experimental research [8]. This delay time consists of: time between start of control signal and beginning of the movement of the servovalve spool (1-2 ms) and the rise time of the corresponding actuator pressure, needed to move off the engine valve (1.5-3 ms). For this reason, the control of this valve drive cannot be done in real time, after start of the control signal at the time corresponding to one position of the crankshaft.

Therefore, to obtain the relevant moments of opening and closing of the valve (crankshaft angles), the control system should obtain a signal, for the time no less than equal to the delay time, before reaching the engine crankshaft position corresponding to the opening of the valve. This will be possible only, if the control system will solicit engine operation parameters in the form of feedback. These parameters, necessary for control signals, will include mainly the angular velocity of the engine crankshaft and the temperature of the working medium. If the control system will be the adaptive system, the angles of rotation of the crankshaft, which took place at the opening and closing of the valve and the actual valve lift must be taken into consideration, too.

Sample waveform of the valve lift is shown in Fig. 4. To obtain such a waveform, control signal with the following components is required:

- 1) the duration of the valve opening signal – t_o ,
- 2) the duration of the valve closing signal – t_z ,
- 3) the duration of the valve braking signal – t_h .

In the course of valve lift the delay time of the drive was labeled as t_{zz} .

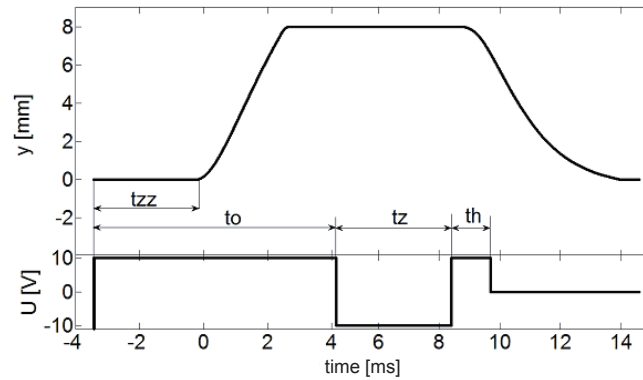

Fig. 4. Characteristic parameters of the control signal necessary to achieve the desired waveform of the valve lift

The duration of valve opening signal will depend mainly on the angular speed of the engine crankshaft. The duration of the closing signal and the braking signal will be fixed for specific ranges of supply pressures and speeds of the crankshaft, which will be achieved with the full opening of the valve, as demonstrated below.

Previous studies (mainly experimental) have shown that minimum valve closing speed for supply pressure 10 MPa was approximately 0.26 m/s. Such speed, from the viewpoint of valve subsidence in the seat, seems acceptable. Valve closing time for such speed, however, would be about 30 ms.

Full opening of the return gap allowed to reach for the valve closing speed is up to 3 m/s. Valve closing time for such speed would be about 3 ms. The aim of the simulation was, inter alia, propose such a method of controlling, to give as small as possible valve closing speed and not significantly increase valve closing time.

Fig. 5 shows the results of the simulation – waveforms of the valve lift and the valve speed for a given stepping changing control signal and the supply pressure of 10 MPa.

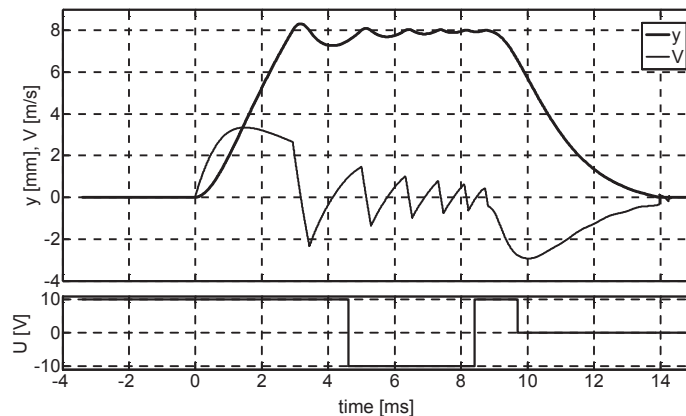

Fig. 5. Waveforms of: valve lift, valve speed and the control signal for a supply pressure of 10 MPa and engine speed 3000 rpm with valve braking

This waveform was established for the duration of the valve lifting of 14 ms, which corresponds to the engine speed equal 3000 rpm (assuming the valve opening angle of 248° of the crankshaft). As can be seen, both the trapezoid waveform of the valve lift and optimal valve opening and valve closing speeds were managed. In addition, adequate braking signal t_h allowed for an acceptably smooth closing the valve. Speed when the valve contacts the valve seat does not exceed 0.3 m/s.

Simulation has also made it possible to calculate the factor W - fill factor of the area under the valve lift curve. For this case, it amounted to $W=0.65$. Especially important for this value was

braking process of the valve. It increased the valve closing time to 5.2 ms. For example in Fig. 6 has been shown waveform of the valve lift without braking it before closing. For this case, fill factor reached $W=0.81$, which is fully satisfactory. The improvement of this fill factor contributed significantly shorter valve closing time amounting to 2.6 ms.

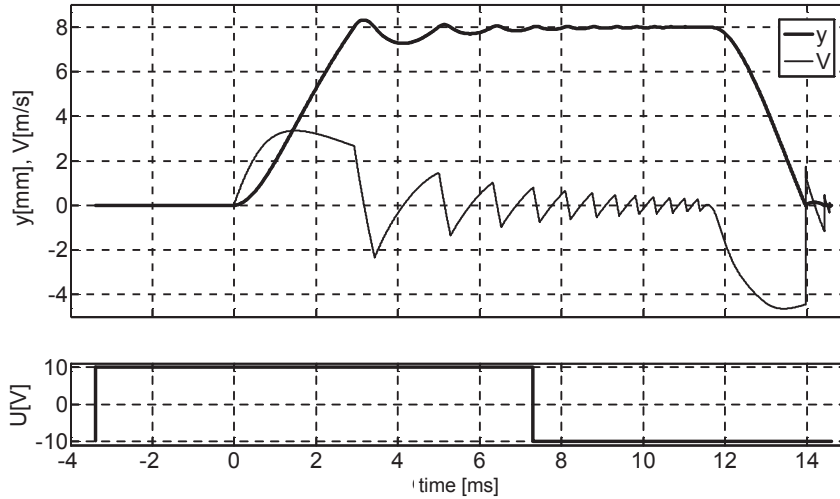

Fig. 6. Waveforms of: valve lift, valve speed and the control signal for a supply pressure of 10 MPa and engine speed 3000 rpm without valve braking

Assuming the valve lifting time 7 ms (corresponding to the angle 248° of the crankshaft for 6000 rpm) and supply pressure of 10 MPa, waveform of valve lift, which sufficiently satisfied theoretical requirements (shown in Fig. 2), was achieved only without valve braking. It was shown in Fig. 7. However, in this case, the settling speed of the valve, which exceeded 4 m/s, may not be acceptable from the point of view of noise and durability.

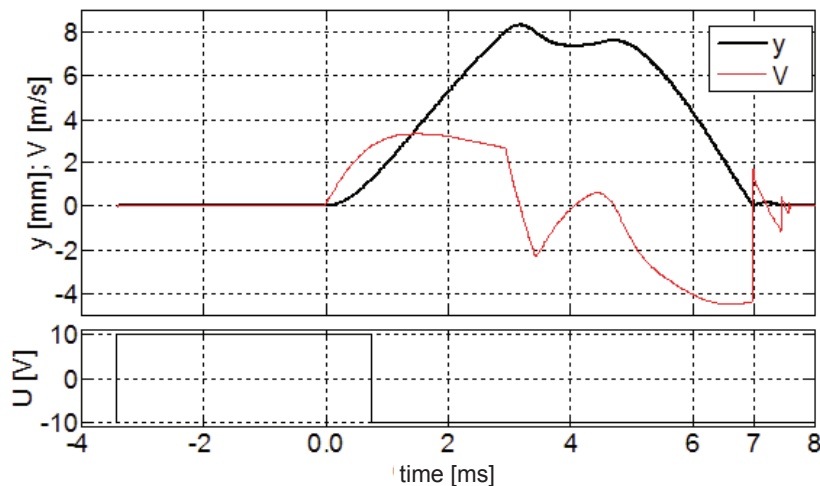

Fig. 7. Close to the theoretical waveforms of: valve lift, valve speed and the control signal for a supply pressure of 10 MPa and engine speed 6000 rpm without valve braking

Fill factor, in this case, was $W=0.62$.

A number of simulations allowed to determine of the optimal control signal to the waveform of the valve lift with braking. Unfortunately, for the valve lifting times corresponding to the engine speed 6000 rpm the full lifting of the valve was not possible to obtain (to this valve drive) – Fig. 8.

In this case, fill factor reached a value of only $W=0.36$. A major impact on its value had: about 2 mm smaller maximum valve lift and valve closing time equal 4.1 ms.

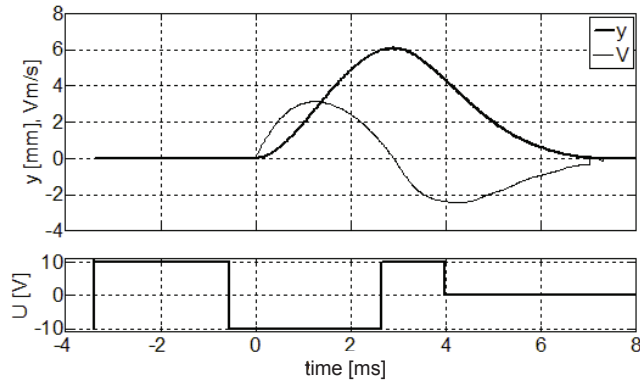

Fig. 8. Waveforms of: valve lift, valve speed and the control signal for a supply pressure of 10 MPa and engine speed 6000 rpm with valve braking

Simulations made for supply pressure equal 14 MPa have shown, that the maximum valve lift was achieved for the valve opening time equal 8 ms – Fig. 9. Unfortunately, even in this case, the fill factor does not exceed the value of 0.5.

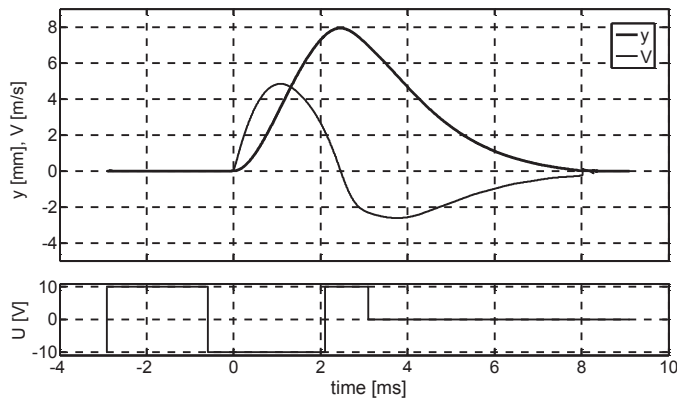

Fig. 9. Waveforms of: valve lift, valve speed and the control signal for a supply pressure of 14 MPa and duration of valve lift 8 ms

Based on simulation studies, comparable fill factors of the cam drive and analyzed electrohydraulic drive with valve braking were obtained for speeds of over 4000 rpm. Above this engine speed fill factor, in the case of an electrohydraulic drive, was significantly reduced. However, for low engine speeds, fill factor accepted values significantly above 0.7 (for example, for engine speed 1500 rpm: with valve braking $W=0.73$, without valve braking $W=0.91$ – Fig. 10).

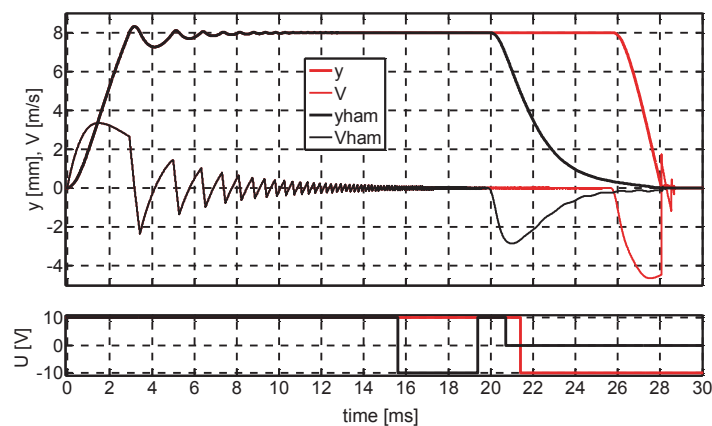

Fig. 10. Waveforms of: valve lift, valve speed and the control signal for a supply pressure of 14 MPa and duration of valve lift 28 ms (black lines-with valve braking, red lines-without valve braking)

Effect of process control on valve lift

Using to the construction of electrohydraulic valve drive servovalve with zero overlap would allow to control the size of the valve lift. For example, the effect of the control signal to the value of the valve lift was shown in Fig. 11. As one can see, there is full opportunity to control the maximum valve lift with a control signal. Reducing the duration of the valve opening signal allows to obtain correspondingly smaller value of the valve lift. Unfortunately, shortening the duration of the opening signal the delay time of the drive significantly increases, what should be included in the control program.

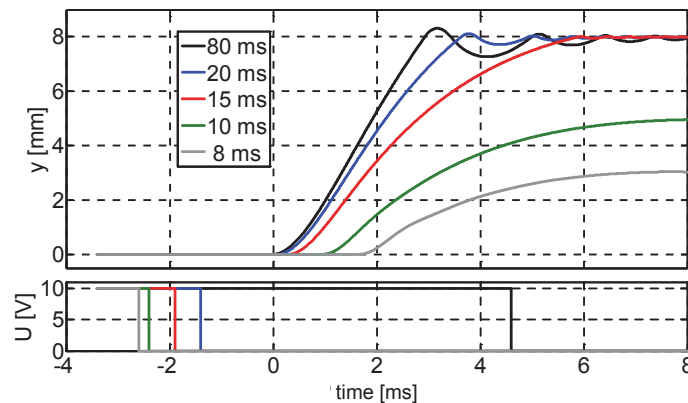

Fig. 11. The effect of control signal duration on valve lift

4. Conclusions

This paper shows results of simulations of a solution electrohydraulic valve drive for internal combustion engines. This simulation model is based on a specially designed drive model, and its verification was performed using the research stand. The results of this work have been described in earlier papers.

From the research the following general conclusions can be drawn:

- drive without valve braking process is producing better fill factor of the area under the valve lift curve of the classic cam drive, almost to the engine speed ranging 6000 rpm,
- valve braking process significantly worsens fill factor and reduces the engine speed, which takes on values better than the classic cam drive,
- it is possible to effectively carry out the valve braking process through the control signal (for proportional valves). However, this requires feedback in the form of valve position measurement,
- use for the construction of electrohydraulic valve drive servovalve with zero overlap will allow to control the size of the valve lift.

Acknowledgement

Ministry of Science and Higher Education supports the work as a research project number NN509292835.

References

- [1] Aaltonen, J., Vilenius, M., *Electrohydraulic Valvetrain for Extreme Value Diesel Engine*, Tampere University of Technology/Institute of Hydraulics and Automation, Tampere, www. IHA_TUKEVA-article_2002, Finland 2002.

- [2] Barros, Da Cunha, S., Hedrick, K., Pisano, A., *Variable Valve Timing By Means of a Hydraulic Actuation*, Society of Automotive Engineers, SP-1523, 2000.
- [3] Brader, J. S., *Development of a Piezoelectric Controlled Hydraulic Actuator for a Camless Engine*, Department of Mechanical Engineering University of South Carolina, 2001.
- [4] Denger, D., Mischker, K., *Die elektrohydraulische Ventilsteuerung*, Motortechnische Zeitschrift, 12, 2004.
- [5] Milovanovic, N., Tuner J., *Requirements for the Valve train and Technologies for Enabling HCCI Over the Entire Operating Range*, Powertrain Research Department, Lotus Engineering, www.automotive.eaton.com, UK. 20.09.2005.
- [6] Smoczyński, M., Szydłowski, T., *Model of Hydraulic Single-acting Drive for Valves of Internal Combustion Engines*, Journal of KONES Powertrain and Transport, Vol. 16, No. 1, pp. 465-472, 2009.
- [7] Szydłowski, T., Smoczyński, M., *Model of Hydraulic Double-acting Drive for Valves of Internal Combustion Engines*, Journal of KONES Powertrain and Transport, Vol. 16, No. 1, pp. 487-494, 2009.
- [8] Szydłowski, T., *Experimental Verification of the Model of Electrohydraulic Drive for Internal Combustion Engine*, Journal of KONES Powertrain and Transport, Vol. 16, No. 3, pp. 401-408, 2009.
- [9] Zbierski, K., Smoczyński, M., *Motion Properties of Hydraulically Actuated Valve Train*, Journal of KONES Powertrain and Transport, Vol. 16, No. 3, pp. 517-526, 2009.
- [10] Zbierski, K., *Koncepcja i bezsilnikowe badania bezkrzywkowego elektrohydraulicznego rozrządu tłokowego silnika spalinowego*, Journal of KONES, 2006.