



## **ASSESSMENT OF ENGINE OPERATION WITH THE USE OF AN OPERATION INDICATOR BASED ON TEST BENCH RESULTS OF A ROBIN-SUBARU EX17 ENGINE**

**Piotr Bzura  
Jacek Rudnicki**

*Gdansk University of Technology  
ul. Narutowicza 11/12, 80-952 Gdansk, Poland  
tel. +48583472573  
e-mail: [pbzura@pg.gda.pl](mailto:pbzura@pg.gda.pl), [jacekrud@pg.gda.pl](mailto:jacekrud@pg.gda.pl)*

**Rafał Grzeszczyk**

*ODIUT Automex Sp.z o.o.  
ul. Marynarki Polskiej 55d, 80-557 Gdansk, Poland*

Abstract

*Paper presents results of an experimental verification of the method of quantitative evaluation of engine operation, presented in the literature, exemplified by a low-power internal combustion piston engine. In accordance with such interpretation, engine operation may be presented as a physical quantity defined as operation indicator. The paper presents results of preliminary tests, processed in that aspect, carried out on an engine test bench. The results have been used as a classifying measure of the engine reliability state.*

**Key words:** *operation, internal combustion piston engine, reliability*

### **1. Introduction**

Rational operation of technical devices and systems requires right operational decisions to be taken. The decisions are based on various premises and of a significant importance among them are reliability characteristics of the operated object.

The reliability analysis is a complex procedure of processing the empirical results gathered in the operational practice supplemented with analytical considerations, which procedure requires, apart from other elements, having access to comprehensive information on the current technical and power state of the object in question.

For identifying and predicting the technical states a suitable diagnostic system must be used. Without such a system it is impossible to acquire the information necessary for controlling the operation process in general and predicting the reliability level in particular.

Due to obvious technical and economic reasons, not all the possible technical states can be diagnosed even in the case of very simple technical objects.

As the process of changes of technical state is stochastic, continuous in terms of the states and time, it is necessary to subdivide that infinite set of states into a finite number of subsets (classes), clearly and permanently identifiable by means of the functioning diagnostic system. In

terms of reliability, selecting from the set of all possible technical states the subsets of significant states is connected with the need of defining precisely the broadly understood failure. For the task reliability (associated with the performed task) of complex technical objects, as are the devices and functional subsystems of a marine power plant, it is useful and practical to distinguish at least two groups of failures understood as:

- events causing inadmissible deviations of the system (device) operation parameters from the critical values – major failures causing unfitness for performing any task whatever;
- events causing only deterioration of the operating qualities – minor failures causing in effect higher cost of performing the task or a need of modifying it.

By adopting such subdivision criteria – capability of an object of carrying out the required functions connected with the objectives defined by the operating system in given conditions – a simple and practically useful for the operation process control set **S** of classes – technical states can be distinguished:

- a) **State  $s_1$**  – subset of technical states of full task fitness. An object in that state is capable of performing all the tasks it has been prepared for in the design and manufacturing phase and the values of its operation (power, economic, ergonomic etc.) parameters are kept within the admissible range.
- b) **State  $s_2$**  – state of partial unfitness (partial fitness) for task execution. Including e.g. an engine to that class of states should occur in the case of:
  - incapability of fulfilling all the required ship design parameters, e.g. the specified speed or sailing range,
  - incapability of maintaining the manufacturer-guaranteed power and economic indicators of the operational process effectiveness, e.g. unit fuel consumption.
- c) **State  $s_3$**  – state of full task incapability which makes it impossible to use the object in accordance with its intended purpose. This subset includes all the states characterised by very significant destruction (extensive failure) of the object.

In the case of transport power systems, the internal combustion piston engines take particular place. The universality of their use, impact on the system safety and ecological properties and also the connected operational costs make the knowledge of their current technical state particularly important from the point of view of timely reaction to any irregularities.

Among many indicators allowing to include that technical state in a synthetic way to one of the above defined classes, it seems sensible to consider the engine operation in such a valuating manner that the operation can be determined simultaneously by energy and time.

Operation within a  $[0, t]$  time range can then be interpreted as a physical quantity – hereinafter called operation indicator ( $D$ ) – determined by a product of the energy  $E = f(t)$  variable in time and the time, which may be generally expressed by the following relation [1, 4]:

$$D = \int_0^t E(\tau) d\tau \quad (1)$$

In the case of general analysis of the compression-ignition engine operation it may be assumed that the energy generated by combustion of fuel in the cylinders produces the engine torque. An effect of transmission of the torque from engine to receiver is the work  $L_e$ , which in this case may be determined from the expression:

$$L_e = M_o \cdot 2\pi n \cdot t \quad (2)$$

where:

$L_e$  – useful work,

$M_o$  – mean torque,

$n$  – engine rotational speed.

From relations (1) and (2), the engine operation indicator may be determined by the formula:

$$D = 2\pi \int_0^t M_0 n t dt \quad (3)$$

By introducing to further considerations the following notions:

- required operation –  $D_W$  necessary for carrying out the intended task (e.g. a transportation task – sea transport of cargo within a determined time – which means maintaining the determined average ship speed, i.e. average power developed by the ship main propulsion engine(s)),
- possible operation –  $D_M$  which the engine in a given technical state and in given functioning conditions is capable of performing,

and by verifying the relation [4]:

$$D_M \geq D_W \quad (4)$$

a criterion can be obtained of evaluation of the fitness for use, e.g. in accordance with principles presented in [4].

Further in this paper an experimental verification is presented of the above mentioned possibility of using the operation indicator as a general classifier of engine state, based on the test bench investigation of a low-power compression-ignition Robin-Subaru EX17 engine.

## 2. Engine diagnostic tests

The investigation of a Robin-Subaru EX17 engine was carried out on a laboratory test bench (Fig.1). This is a single-cylinder four-stroke carburettor engine fuelled with lead-free petrol, splash-lubricated with the SAE 30 CastolGarden oil.

*Table 1. Basic characteristics of the Robin-Subaru EX17 engine*

Rated power	2.6 kW
Cylinder diameter	67 mm
Nominal rotational speed	3000 revs/min
Engine displacement	169 cm <sup>3</sup>
Compression ratio	85

The engine power was determined by means of an electric rotational brake with a control system allowing to measure the engine torque  $M$  [Nm].

The rotational speed was measured with an inductive gauge cooperating with a toothed wheel, where the consecutive teeth are the shaft position indicators.

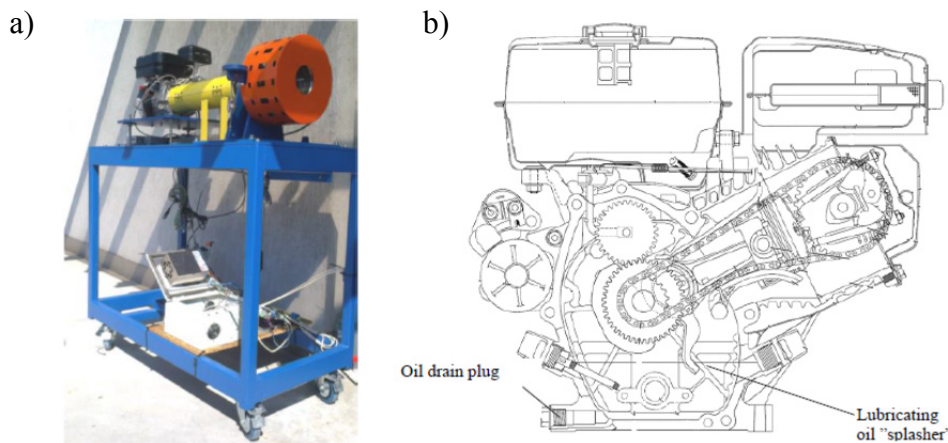

*Fig. 1. View of the Robin-Subaru EX17 engine test stand (a) and the engine cross-section (b)*

The investigation was performed in the form of a simple active experiment and was aimed at verification of the operation time of engine in three different fitness states, operating on 100 cm<sup>3</sup> of the 95 Lotos lead-free petrol with 720 kg/m<sup>3</sup> density and with the same loads. The following state classes were distinguished:

State 1 – state of full fitness.

State 2 – state of partial fitness – damaged lubrication oil splasher (Fig. 2).

State 3 – state of partial fitness – dirty air filter (Fig. 2).

a)



b)

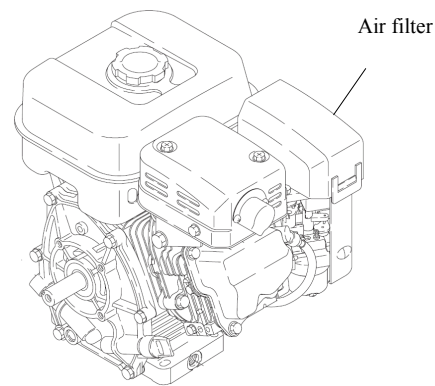

Fig. 2. Damaged oil splasher (a) and location of the air filter (b)

### 3. Investigation results and their analysis

The test was carried out for three values of the engine braking torque: 2.5 Nm, 5 Nm and 7.5 Nm, the engine operation time  $t_{OP}$  on 100 cm<sup>3</sup> of fuel was measured for each of those loads. Each measurement was repeated five times. Examples of the measurement results are presented in Fig. 3 and 4.

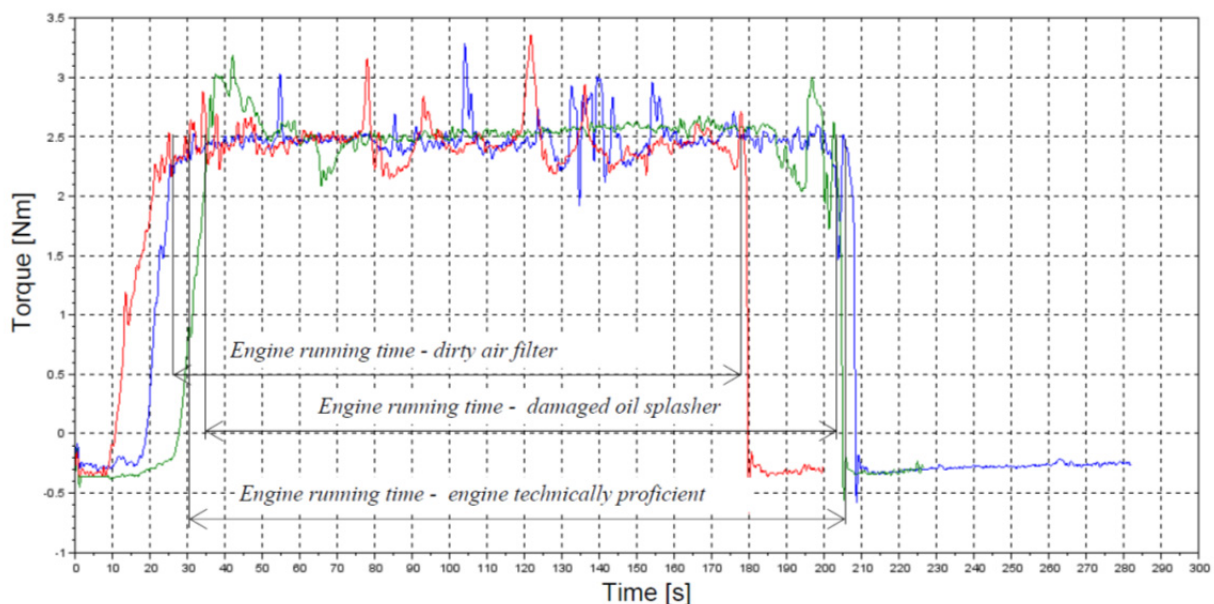

Fig. 3. Engine running time with braking torque value 2.5Nm

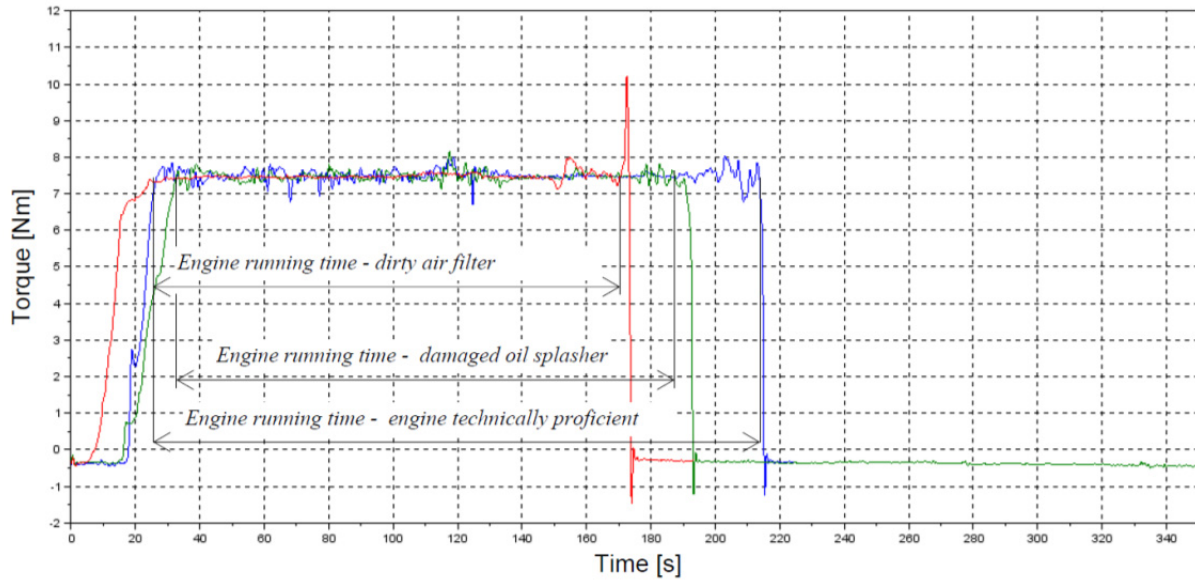

Fig. 4. Engine running time with braking torque value 7.5Nm

The analysed engine operating conditions made it possible to determine:

- numbers of the performed engine operation cycles within the  $t_{OP}$  time for different states of fitness and different loads [2,3] (Table 1),

Table 1: Comparison of the numbers of engine operation cycles

Engine state	Number of engine cycles with load $M=2.5Nm$	Number of engine cycles with load $M=5 Nm$	Number of engine cycles with load $M=7.5Nm$
State 1	323434	366504	297609
State 2	294742	296688	232500
State 3	172500	227050	207000

- values of work performed by the engine in the period  $(0, t_{OP})$  of its operation in accordance with expression (2),

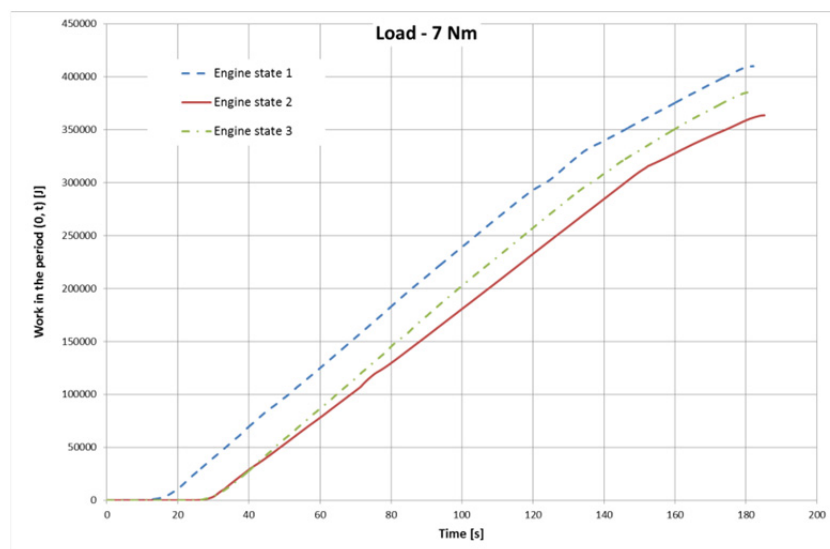

Fig. 5. Values of work performed by the engine in the period  $(0, t_{OP})$  of its operation with a 7.5 Nm torque load

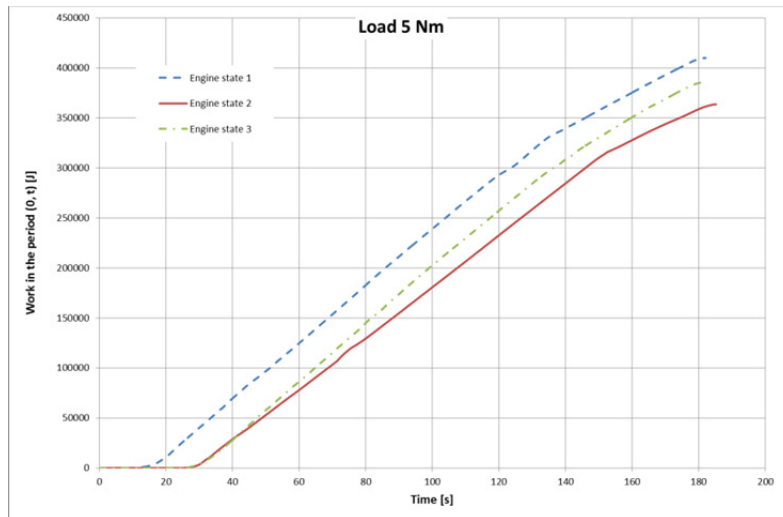

Fig. 6. Values of work performed by the engine in the period  $(0, t_{OP})$  of its operation with a 5 Nm torque load

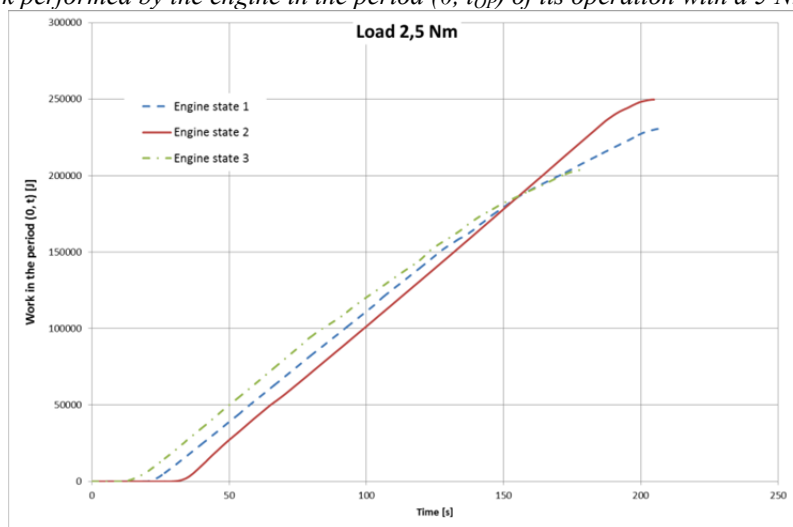

Fig. 7. Values of work performed by the engine in the period  $(0, t_{OP})$  of its operation with a 2.5 Nm torque load

- values of the engine operation indicators in the period  $(0, t_{OP})$  of its operation in accordance with expression (3).

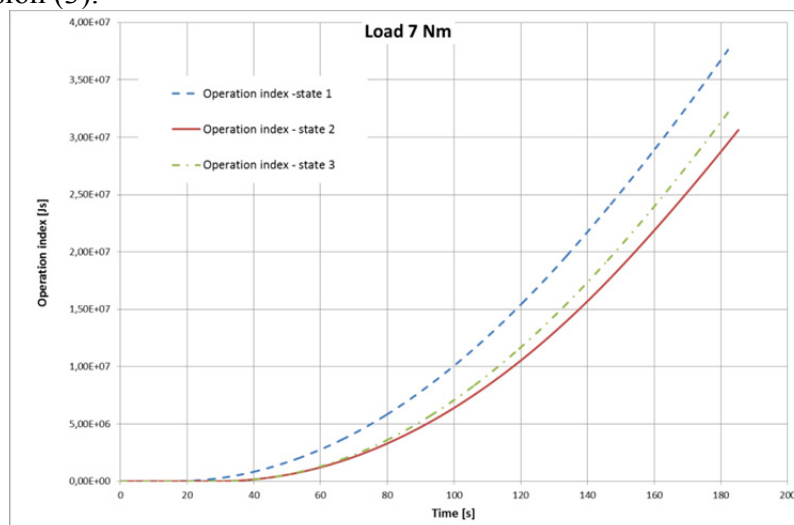

Fig. 8. Values of the engine operation indicator in the period  $(0, t_{OP})$  of its operation with a 7.5 Nm torque load



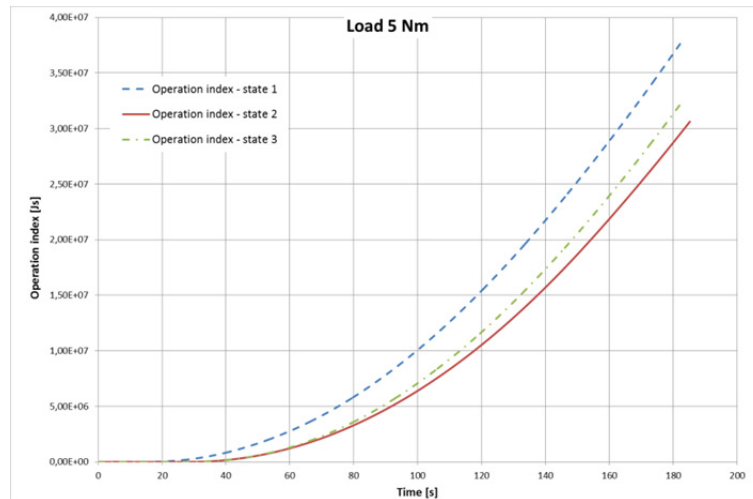

Fig. 9. Values of the engine operation indicator in the period  $(0, t_{OP})$  of its operation with a 5 Nm torque load

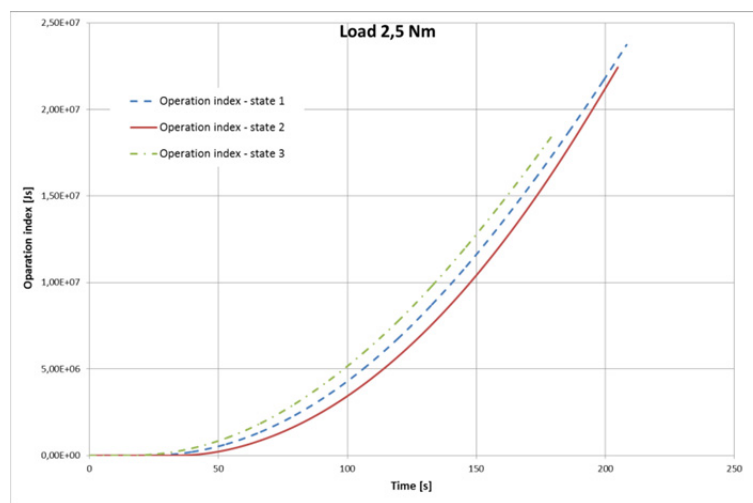

Fig. 10. Values of the engine operation indicator in the period  $(0, t_{OP})$  of its operation with a 2.5 Nm torque load

Analysis of the results presented in figures 5 to 10 and in Table 1 allows to formulate the following conclusions:

- engine operating in the state of full fitness is characterised by the longest operation time and the greatest number of performed work cycles with a given braking torque;
- assessment of the engine fitness by the value of work performed in the period of its operation (figures 5 to 7) may lead to erroneous conclusions, because, as it can be seen in Fig. 7, work performed by the engine in a partial fitness state (in this case state 2) reached a higher value than in the full fitness state (state 1);
- using the engine operation indicator as a classifier of the engine reliability state always leads to correct conclusions, because for the full fitness state it takes the highest values regardless of the load.

#### 4. Final remarks and conclusions

Presented interpretation of engine operation makes it possible to formulate a preliminary assessment of the engine degree of fitness.

The presented method is, in the opinion of the Authors, a valuable complement to the so far applied methods of describing the reliability aspects of a so important element of most drive systems as an internal combustion piston engine. The basic advantageous feature of the method is

connecting the evaluation of power with the time of task execution, which is very important particularly in the case of carrying out long-lasting transportation tasks.

An additional advantage is its universality and therefore applicability to the reliability analysis of any power device or subsystem.

## References

- [1] Girtler J., *Metoda oceny działania maszyn z zastosowaniem diagnostyki technicznej*, Wojskowa Akademia Techniczna, Wydział Elektroniki, Warszawa 2013
- [2] Jędrzejowski J., *Obliczanie tłokowego silnika spalinowego*, Wydawnictwo Naukowo-Techniczne, Warszawa 1988
- [3] Niewiarowski K., *Tłokowe silniki spalinowe*, Wydawnictwo Naukowo-Techniczne, Warszawa 1983.
- [4] Rudnicki J., *Energy-time method for assessment of main diesel engine operation*, Journal of KONES Powertrain and Transport. - Vol. 14, nr 3 (2007), s. 519-526